

HDSM-541x, HDSM-543x

0.56 in. (14.22 mm) Dual-Digit Surface-Mount LED Display

Description

The Broadcom[®] HDSM-541x/543x is a dual-digit display of 0.56 in. (14.22mm) height. This device uses AlInGaP/GaAs chips and has a grey top surface with white segments.

Features

- 0.56 in. digit height
- Low current operation
- Excellent characters appearance
- Available in CA and CC
- 500 pieces per reel
- Moisture sensitivity level: Level 3
- RoHS compliant

Ordering Information

Red	Green	Yellow	Orange	Description
HDSM-541C	HDSM-541H	HDSM-541F	HDSM-541L	Common Anode, Right Hand Decimal
HDSM-543C	HDSM-543H	HDSM-543F	HDSM-543L	Common Cathode, Right Hand Decimal

Package Dimensions

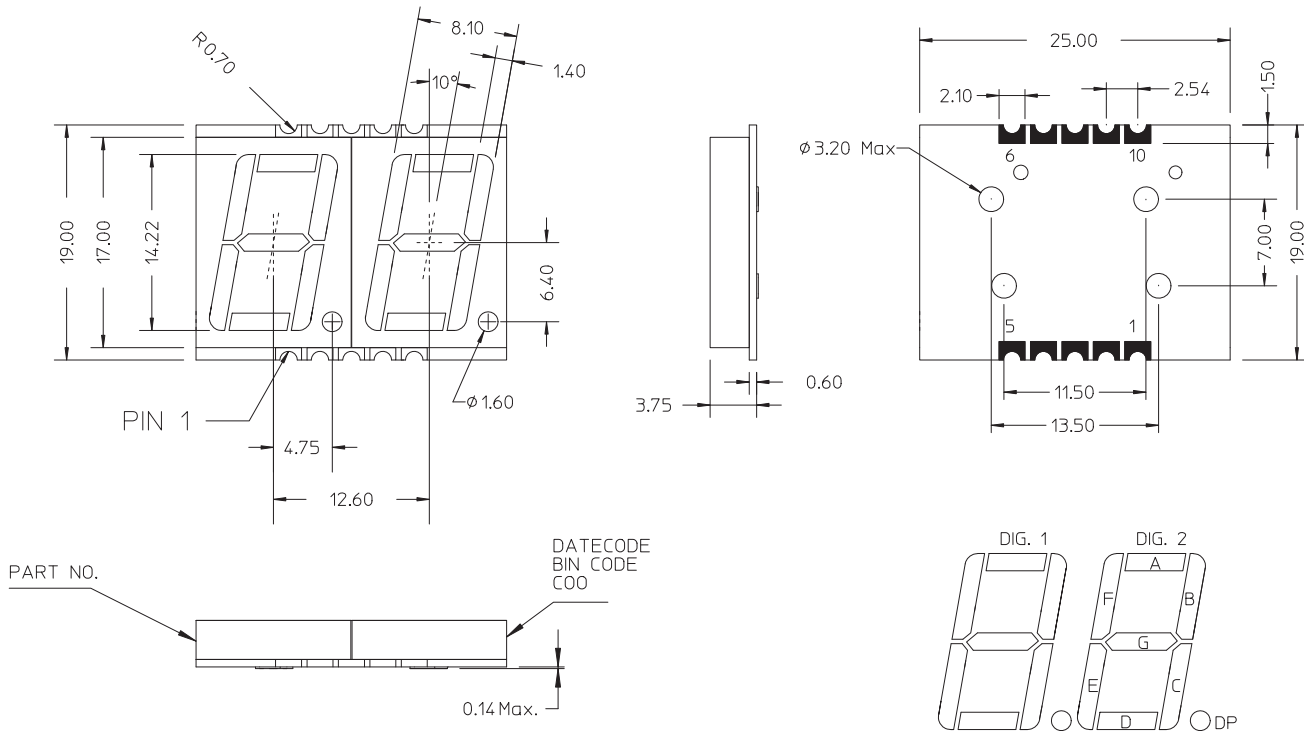

NOTE:

1. All dimensions are in millimeters (inches).
2. Tolerance ± 0.25 mm (0.01 in.) unless otherwise noted.

Pin Connection (Common Anode)

Pin Number	Connection
1	CATHODE G
2	CATHODE DP
3	CATHODE A
4	CATHODE F
5	COMMON ANODE DIG2
6	CATHODE D
7	CATHODE E
8	CATHODE C
9	CATHODE B
10	COMMON ANODE DIG1

Pin Connection (Common Cathode)

Pin Number	Connection
1	ANODE G
2	ANODE DP
3	ANODE A
4	ANODE F
5	COMMON CATHODE DIG2
6	ANODE D
7	ANODE E
8	ANODE C
9	ANODE B
10	COMMON CATHODE DIG1

Internal Circuit Diagram (Common Anode)

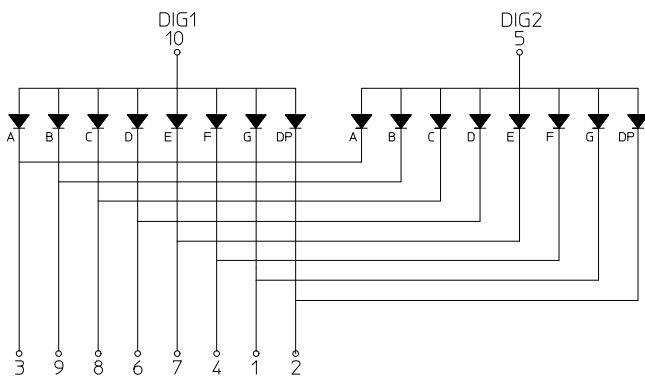

Internal Circuit Diagram (Common Cathode)

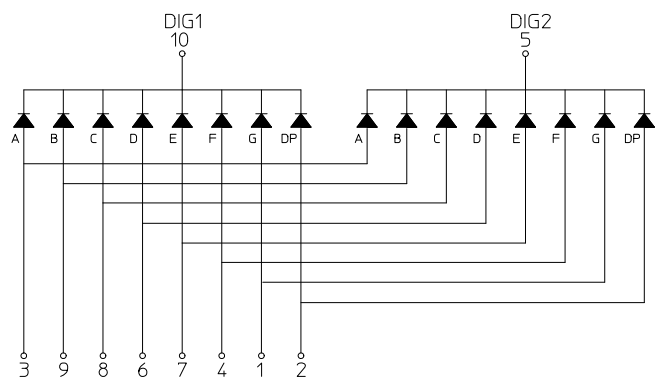

Absolute Maximum Ratings at $T_A = 25^\circ\text{C}$

Parameter	Green/Yellow/Red/Orange	Units
Power Dissipation Per Segment	65	mW
Peak Forward Current Per Segment (1/10 Duty Cycle, 0.1-ms pulse width)	100	mA
Continuous Forward Current Per Segment	25	mA
Derating Linearly From 25°C Per Segment	0.25	mA/°C
Reverse Voltage Per Segment	5	V
Operating Temperature Range	-40°C to +105°C	
Storage Temperature Range	-40°C to +105°C	

Electrical/Optical Characteristics at $T_A = 25^\circ\text{C}$

Green

Parameters	Symbol	Min.	Typ.	Max.	Units	Test Condition
Average Luminous Intensity	I_V	5.4	10.5	—	mcd	$I_F = 10 \text{ mA}$
Emissions Wavelength	λ_p/λ_d	—	572/571	—	nm	$I_F = 20 \text{ mA}$
Spectral Line Half-Width	$\Delta\lambda$	—	20	—	nm	$I_F = 20 \text{ mA}$
Forward Voltage, Per Segment	V_F	—	2.1	2.6	V	$I_F = 20 \text{ mA}$
Reverse Current, Per Segment	I_R	—	—	100	μA	$V_R = 5\text{V}$
Luminous Intensity Matching Ratio	I_{V-M}	—	—	2:1		$I_F = 10 \text{ mA}$

Yellow

Parameters	Symbol	Min.	Typ.	Max.	Units	Test Condition
Average Luminous Intensity	I_V	8.6	20	—	mcd	$I_F = 10 \text{ mA}$
Emissions Wavelength	λ_p/λ_d	—	591/589	—	nm	$I_F = 20 \text{ mA}$
Spectral Line Half-Width	$\Delta\lambda$	—	15	—	nm	$I_F = 20 \text{ mA}$
Forward Voltage, Per Segment	V_F	—	2.1	2.6	V	$I_F = 20 \text{ mA}$
Reverse Current, Per Segment	I_R	—	—	100	μA	$V_R = 5\text{V}$
Luminous Intensity Matching Ratio	I_{V-M}	—	—	2:1		$I_F = 10 \text{ mA}$

Red

Parameters	Symbol	Min.	Typ.	Max.	Units	Test Condition
Average Luminous Intensity	I_V	8.6	16.0	—	mcd	$I_F = 10 \text{ mA}$
Emissions Wavelength	λ_p/λ_d	—	644/630	—	nm	$I_F = 20 \text{ mA}$
Spectral Line Half-Width	$\Delta\lambda$	—	20	—	nm	$I_F = 20 \text{ mA}$
Forward Voltage, Per Segment	V_F	—	2.0	2.6	V	$I_F = 20 \text{ mA}$
Reverse Current, Per Segment	I_R	—	—	100	μA	$V_R = 5\text{V}$
Luminous Intensity Matching Ratio	I_{V-M}	—	—	2:1		$I_F = 10 \text{ mA}$

Orange

Parameters	Symbol	Min.	Typ.	Max.	Units	Test Condition
Average Luminous Intensity	I_V	8.6	19.5	—	mcd	$I_F = 10 \text{ mA}$
Emissions Wavelength	λ_p/λ_d	—	611/605	—	nm	$I_F = 20 \text{ mA}$
Spectral Line Half-Width	$\Delta\lambda$	—	17	—	nm	$I_F = 20 \text{ mA}$
Forward Voltage, Per Segment	V_F	—	2.1	2.6	V	$I_F = 20 \text{ mA}$
Reverse Current, Per Segment	I_R	—	—	100	μA	$V_R = 5\text{V}$
Luminous Intensity Matching Ratio	I_{V-M}	—	—	2:1		$I_F = 10 \text{ mA}$

Typical Electrical/Optical Characteristic Curves at $T_A = 25^\circ\text{C}$

Green

Figure 1: Relative Luminous Intensity vs. Wavelength

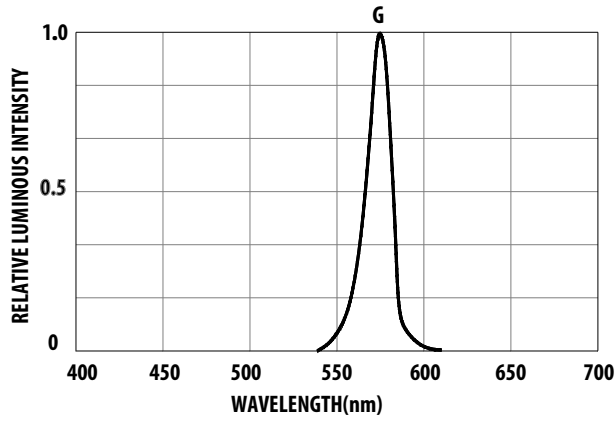

Figure 2: Relative Luminous Intensity vs. Forward Current

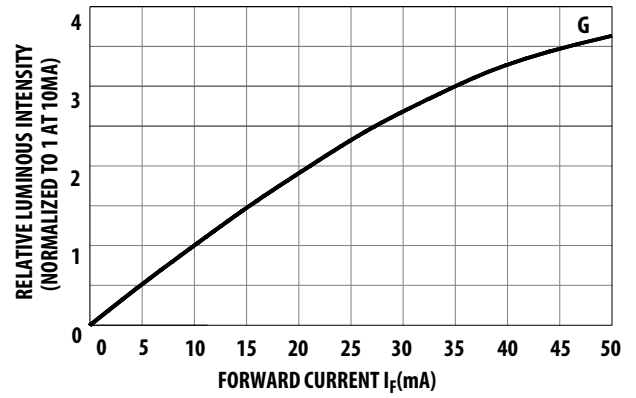

Figure 3: Allowable DC Current vs. Ambient Temperature

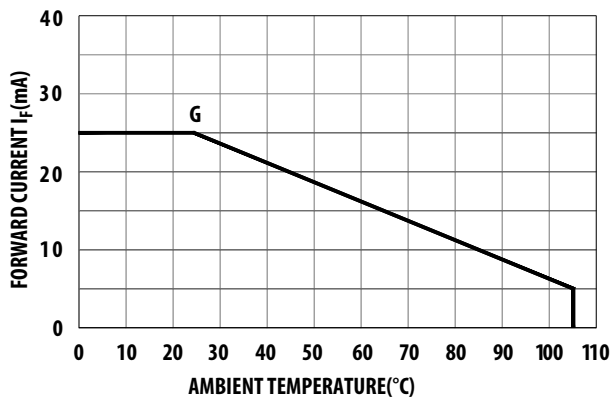
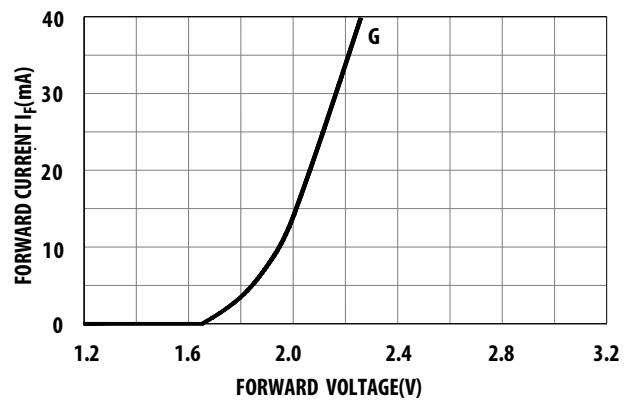

Figure 4: Forward Current vs. Forward Voltage



Typical Electrical/Optical Characteristic Curves at $T_A = 25^\circ\text{C}$

Yellow

Figure 5: Relative Intensity vs. Wavelength

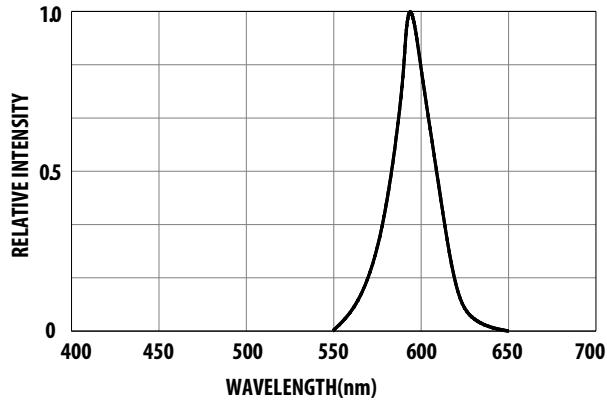

Figure 6: Relative Intensity vs. Forward Current

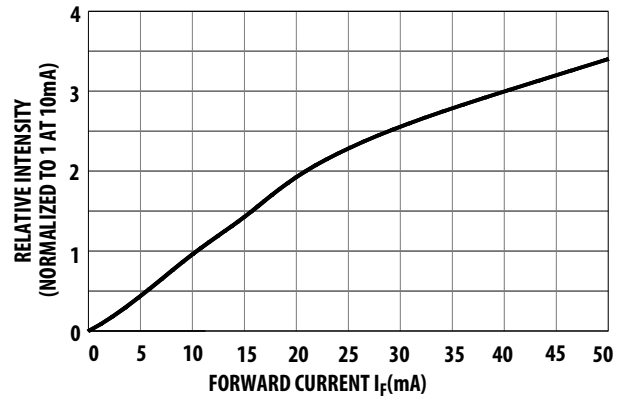

Figure 7: Allowable DC Current vs. Ambient Temperature

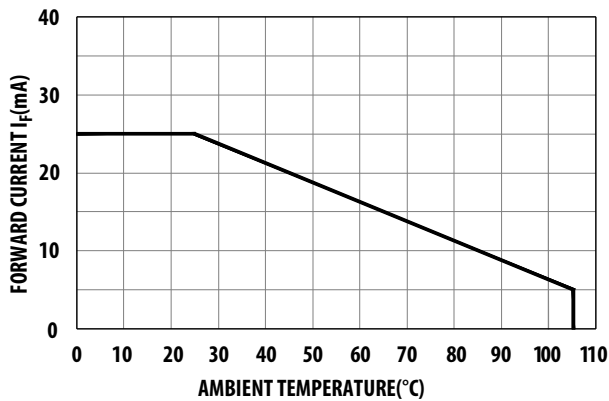
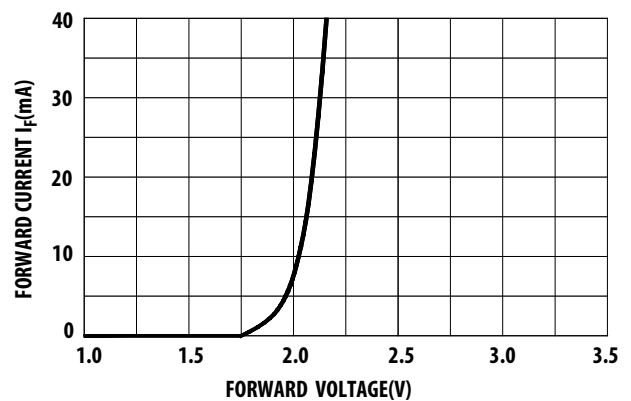

Figure 8: Forward Current vs. Forward Voltage



Typical Electrical/Optical Characteristic Curves at $T_A = 25^\circ\text{C}$

Red

Figure 9: Relative Luminous Intensity vs. Wavelength

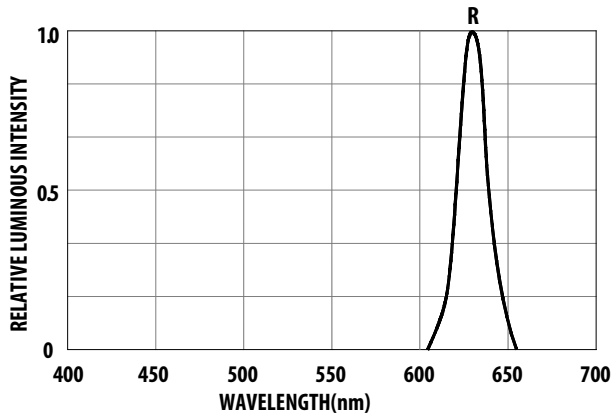

Figure 10: Relative Luminous Intensity vs. Forward Current

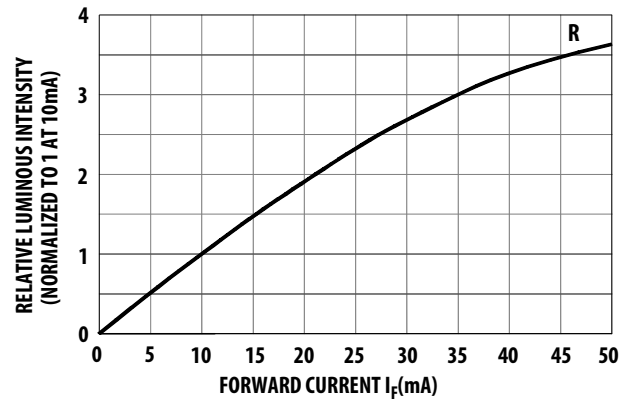

Figure 11: Allowable DC Current vs. Ambient Temperature

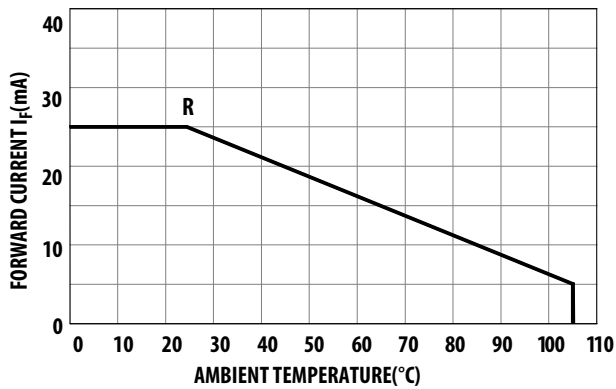
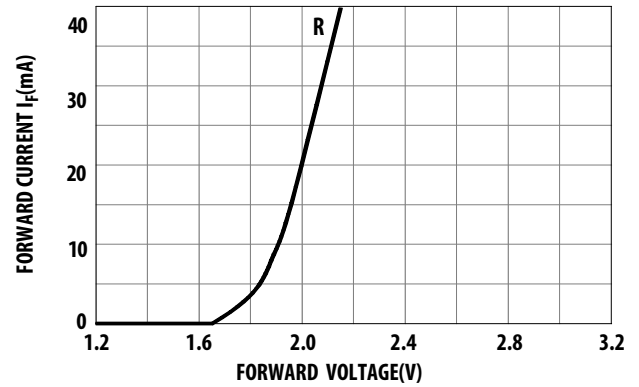

Figure 12: Forward Current vs. Forward Voltage



Typical Electrical/Optical Characteristic Curves at $T_A = 25^\circ\text{C}$

Orange

Figure 13: Relative Intensity vs. Wavelength

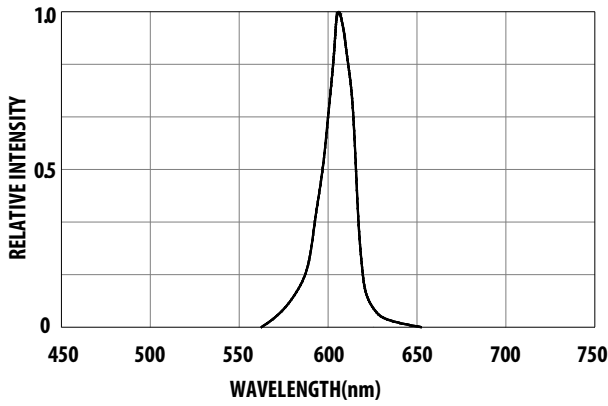

Figure 14: Relative Intensity vs. Forward Current

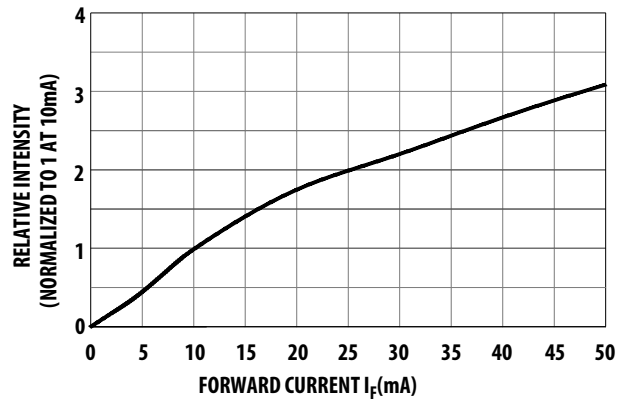

Figure 15: Allowable DC Current vs. Ambient Temperature

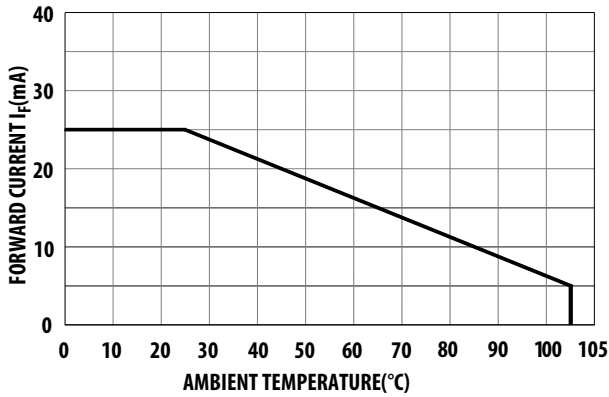
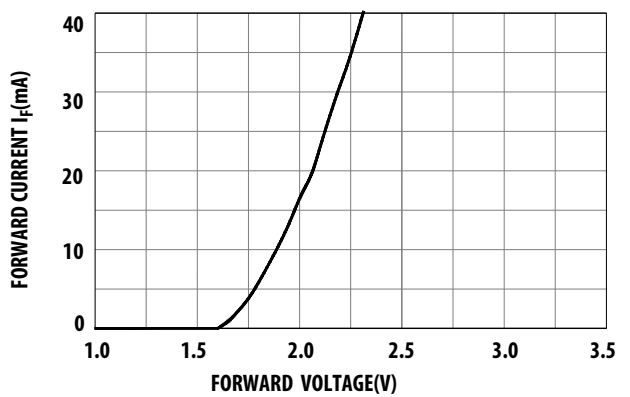

Figure 16: Forward Current vs. Forward Voltage



Intensity Bin Limits (mcd)

Green

IV Bin Category	Min.	Max.
M	5.401	8.600
N	8.601	13.700
P	13.701	21.800
Q	21.801	37.400

Tolerance: $\pm 15\%$.

NOTE: Bin categories are established for classification of products. Products may not be available in all categories. Contact your Broadcom representative for information on currently available bins.

Yellow/Red/Orange

IV Bin Category	Min.	Max.
N	8.601	13.700
P	13.701	21.800
Q	21.801	34.700
R	34.701	55.200

Tolerance: $\pm 15\%$.

SMT Soldering Profile

Pb-Free Reflow Soldering Profile

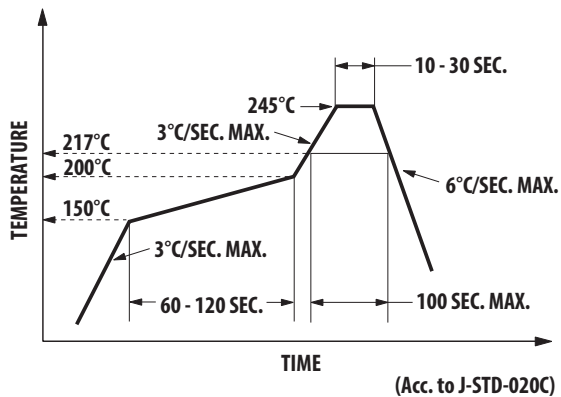

NOTE:

1. The peak temperature refers to the peak package body temperature.
2. The number of reflow processes shall be limited to a maximum of twice only. A cooling process to normal temperature is required between the first and second soldering processes.

Recommended Soldering Pattern (Unit: mm)

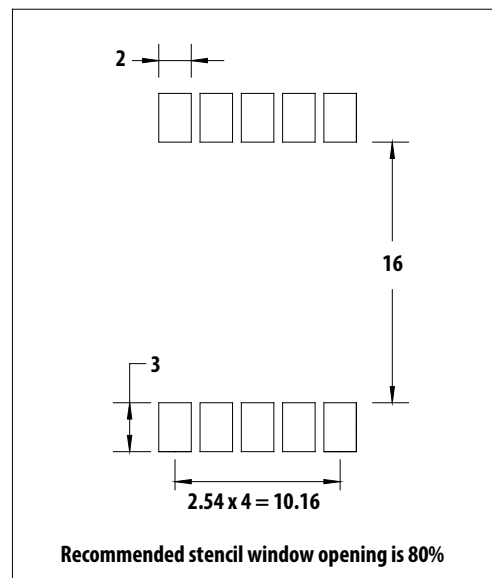

Tape Specification (Unit: mm)

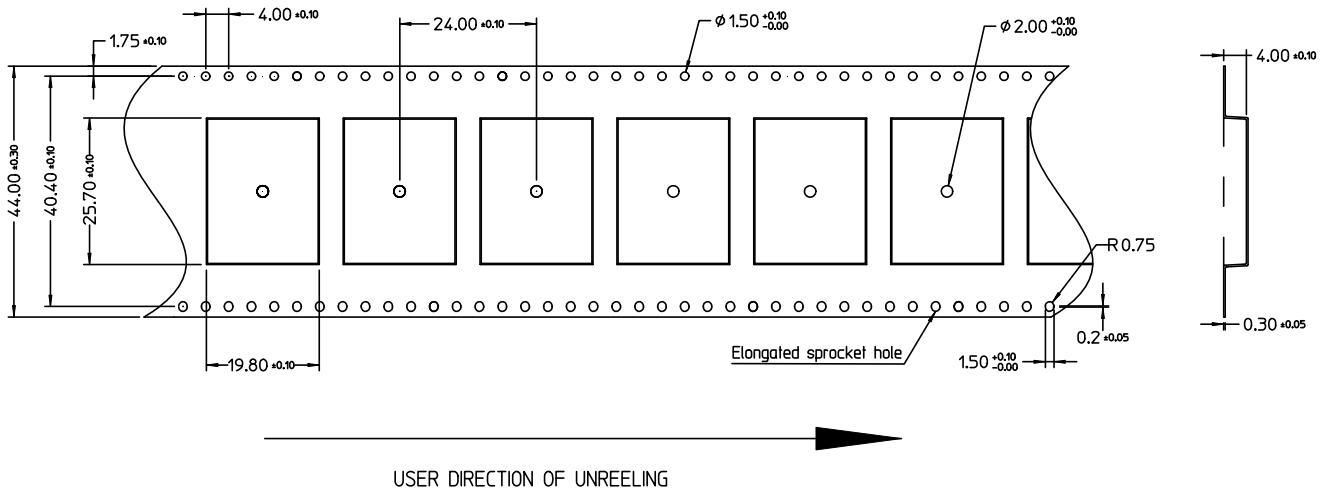

Broadcom, the pulse logo, Connecting everything, Avago Technologies, Avago, and the A logo are among the trademarks of Broadcom and/or its affiliates in the United States, certain other countries, and/or the EU.

Copyright © 2015–2018 Broadcom. All Rights Reserved.

The term “Broadcom” refers to Broadcom Inc. and/or its subsidiaries. For more information, please visit www.broadcom.com.

Broadcom reserves the right to make changes without further notice to any products or data herein to improve reliability, function, or design. Information furnished by Broadcom is believed to be accurate and reliable. However, Broadcom does not assume any liability arising out of the application or use of this information, nor the application or use of any product or circuit described herein, neither does it convey any license under its patent rights nor the rights of others.



Mouser Electronics

Authorized Distributor

Click to View Pricing, Inventory, Delivery & Lifecycle Information:

[Broadcom Limited:](#)

[HDSM-541C](#)