

ISL28194

Ultra-Small, 330nA and 1µA Single Supply, Rail-to-Rail Input/Output (RRIO) Op Amps

FN6236
Rev 5.00
January 14, 2014

The ISL28194 is micropower op amps optimized for low-power applications. The part is designed for single-supply operation from 1.8V to 5.5V, making it suitable for applications with two 1.5V alkaline batteries. The ISL28194 consumes typically 330nA of supply current. The part feature rail-to-rail input and output swing (RRIO), allowing for maximum battery usage.

Equipped with a shutdown pin, the part draw typically 2nA when off. The combination of small footprint, low power, single supply, and rail-to-rail operation makes it ideally suited for all battery operated device.

Pinouts

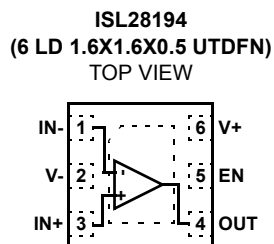
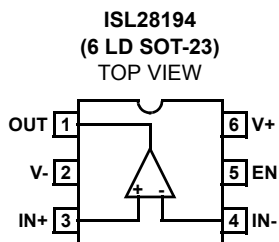

Features

- Typical Supply Current 330nA
- Ultra-Low Single-Supply Operation Down to +1.8V
- Rail-to-Rail Input/Output Voltage Range (RRIO)
- Maximum 2mV Offset Voltage
- Maximum 60pA Input Bias Current
- 3.5kHz Gain Bandwidth Product
- ENABLE Pin Feature
- -40°C to +125°C Operation
- Pb-Free (RoHS Compliant)

Applications

- 2-Cell Alkaline Battery-Powered/Portable Systems
- Window Comparators
- Threshold Detectors/Discriminators
- Mobile Communications
- Low Power Sensors

Ordering Information

PART NUMBER (Note 1)	PART MARKING	PACKAGE Tape and Reel (Pb-Free)	PKG. DWG. #
ISL28194FHZ-T7 (Note 2)	GABK (Note 4)	6 Ld SOT-23	P6.064A
ISL28194FRUZ-T7 (Note 3)	M3	6 Ld 1.6x1.6x0.5 UTDFN	L6.1.6x1.6A
ISL28194EVAL1Z	Evaluation Board		

NOTES:

1. Please refer to [TB347](#) for details on reel specifications.
2. These Intersil Pb-free plastic packaged products employ special Pb-free material sets, molding compounds/die attach materials, and 100% matte tin plate plus anneal (e3 termination finish, which is RoHS compliant and compatible with both SnPb and Pb-free soldering operations). Intersil Pb-free products are MSL classified at Pb-free peak reflow temperatures that meet or exceed the Pb-free requirements of IPC/JEDEC J STD-020.
3. These Intersil Pb-free plastic packaged products employ special Pb-free material sets; molding compounds/die attach materials and NiPdAu plate - e4 termination finish, which is RoHS compliant and compatible with both SnPb and Pb-free soldering operations. Intersil Pb-free products are MSL classified at Pb-free peak reflow temperatures that meet or exceed the Pb-free requirements of IPC/JEDEC J STD-020.
4. The part marking is located on the bottom of the part.

Absolute Maximum Ratings ($T_A = +25^\circ\text{C}$)

Supply Voltage (V_+ , V_-)	5.75V
Supply Turn On Voltage Slew Rate	1V/ μs
Differential Input Current	5mA
Differential Input Voltage	$V_- - 0.5\text{V}$ to $V_+ + 0.5\text{V}$
ESD Rating	
Human Body Model	3kV
Machine Model	300V

Thermal Information

Thermal Resistance (Typical, Note 5)	θ_{JA} ($^\circ\text{C}/\text{W}$)
6 Ld SOT-23	230
6 Ld UTDFN	118
Output Short-Circuit Duration	Indefinite
Ambient Operating Temperature Range	-40°C to $+125^\circ\text{C}$
Storage Temperature Range	-65°C to $+150^\circ\text{C}$
Operating Junction Temperature	$+125^\circ\text{C}$
Pb-Free Reflow Profile	see link below
	http://www.intersil.com/pbfree/Pb-FreeReflow.asp

CAUTION: Do not operate at or near the maximum ratings listed for extended periods of time. Exposure to such conditions may adversely impact product reliability and result in failures not covered by warranty.

NOTE:

5. θ_{JA} is measured with the component mounted on a high effective thermal conductivity test board in free air. See Tech Brief [TB379](#) for details.

IMPORTANT NOTE: All parameters having Min/Max specifications are guaranteed. Typical values are for information purposes only. Unless otherwise noted, all tests are at the specified temperature and are pulsed tests, therefore: $T_J = T_C = T_A$

Electrical Specifications $V_+ = 5\text{V}$, $V_- = 0\text{V}$, $V_{CM} = 2.5\text{V}$, $T_A = +25^\circ\text{C}$, Unless Otherwise Specified.
Boldface limits apply over -40°C to $+125^\circ\text{C}$.

PARAMETER	DESCRIPTION	CONDITIONS	MIN (Note 6)	TYP	MAX (Note 6)	UNIT
V_{OS}	Input Offset Voltage		-2	-0.1	2	mV
			-2.5		2.5	mV
$\frac{\Delta V_{OS}}{\Delta T}$	Input Offset Voltage vs Temperature			1.5		$\mu\text{V}/^\circ\text{C}$
I_{OS}	Input Offset Current		-60	10	60	pA
			-100		100	pA
I_B	Input Bias Current		-80	15	80	pA
			-150		150	pA
e_N	Input Noise Voltage Peak-to-Peak	$f = 0.1\text{Hz}$ to 10Hz		10		μV_{P-P}
	Input Noise Voltage Density	$f_o = 100\text{Hz}$		265		$\text{nV}/\sqrt{\text{Hz}}$
i_N	Input Noise Current Density	$f_o = 100\text{Hz}$		0.7		$\text{pA}/\sqrt{\text{Hz}}$
CMIR	Common Mode Input Range	Established by CMRR test	0		5	V
CMRR	Common-Mode Rejection Ratio	$V_{CM} = 0.5\text{V}$ to 3.5V	70	100		dB
		$V_{CM} = 0\text{V}$ to 5V	55	90		dB
PSRR	Power Supply Rejection Ratio	$V_+ = 1.8\text{V}$ to 5.5V	70	100		dB
			70			
A_{VOL}	Large Signal Voltage Gain	$V_O = 0.5\text{V}$ to 3.5V , $R_L = 100\text{k}\Omega$, $R_L = 10\text{k}\Omega$	75	115		dB
V_{OUT}	Maximum Output Voltage Swing R_L terminated to $V_+/2$	Output low, $R_L = 100\text{k}\Omega$		25	40	mV
		Output low, $R_L = 10\text{k}\Omega$		50	70	mV
		Output high, $R_L = 100\text{k}\Omega$	4.96	4.975		V
		Output high, $R_L = 10\text{k}\Omega$	4.93	4.94		V
SR	Slew Rate	$\pm 1.5\text{V}$, $A_V = 2$		1.2		V/ms
GBW	Gain Bandwidth Product	$A_V = 101$; $R_L = 10\text{k}\Omega$		3.5		kHz
$I_{S,ON}$	Supply Current, Enabled			330	450 500	nA
$I_{S,OFF}$	Supply Current, Disabled	EN = 0.4V		2	20	nA
					50	nA
I_{SC+}	Short Circuit Sourcing Capability	$R_L = 10\Omega$	9	11		mA

Electrical Specifications $V_+ = 5V, V_- = 0V, V_{CM} = 2.5V, T_A = +25^\circ C$, Unless Otherwise Specified.
Boldface limits apply over $-40^\circ C$ to $+125^\circ C$. (Continued)

PARAMETER	DESCRIPTION	CONDITIONS	MIN (Note 6)	TYP	MAX (Note 6)	UNIT
I_{SC-}	Short Circuit Sinking Capability R_L terminated to $V_+/2$	$R_L = 10\Omega$	11	12		mA
V_+	Supply Voltage Range		1.8		5.5	V
ENABLE INPUT						
V_{INH}	Enable Pin High Level		$(V_+) \times (0.8)$			V
V_{INL}	Enable Pin Low Level				0.4	V
I_{ENH}	Enable Pin Input Current	$V_{EN} = 5V$		30	150 200	nA
I_{ENL}	Enable Pin Input Current	$V_{EN} = 0V$		30	150 200	nA

NOTE:

- 6. Parameters with MIN and/or MAX limits are 100% tested at $+25^\circ C$, unless otherwise specified. Temperature limits established by characterization and are not production tested.

Typical Performance Curves $V_+ = 5V, V_- = 0V, V_{CM} = 2.5V$, Unless Otherwise Specified.

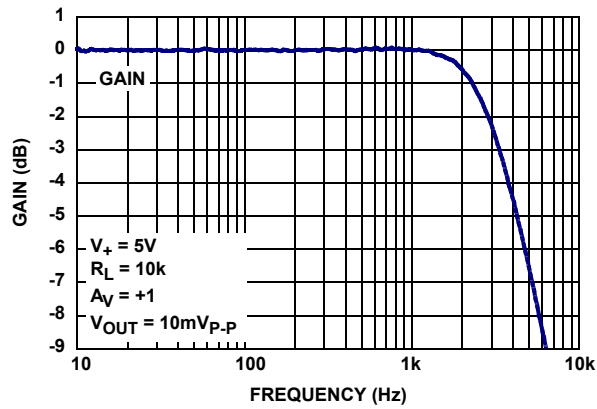

FIGURE 1. CLOSE LOOP GAIN vs FREQUENCY

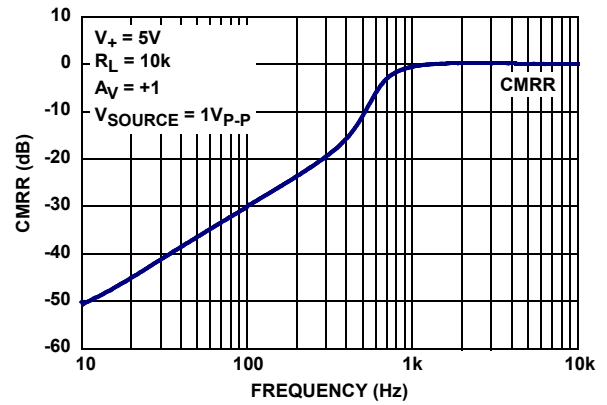

FIGURE 2. CMRR vs FREQUENCY

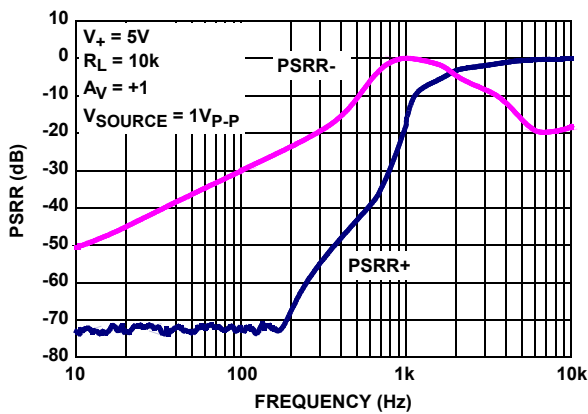

FIGURE 3. PSRR vs FREQUENCY

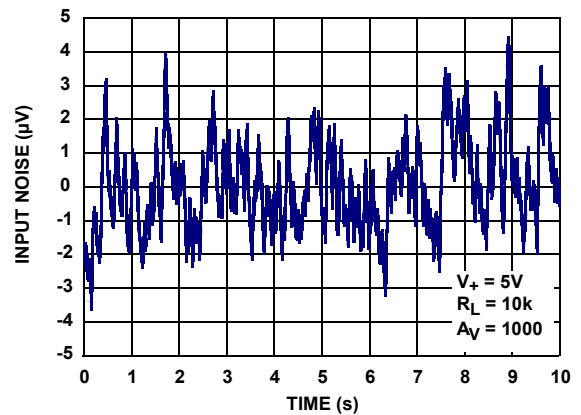

FIGURE 4. 0.1Hz TO 10Hz INPUT VOLTAGE NOISE

Typical Performance Curves $V_+ = 5V$, $V_- = 0V$, $V_{CM} = 2.5V$, Unless Otherwise Specified. (Continued)

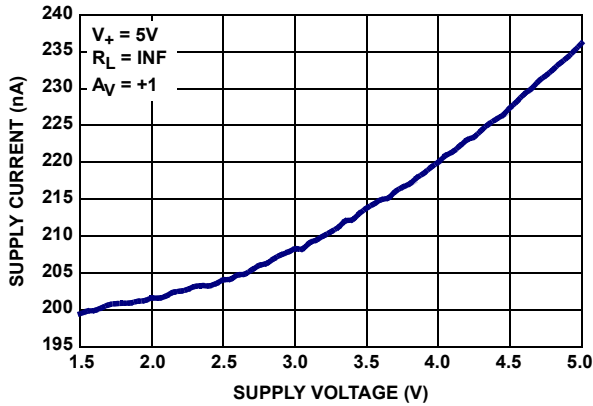

FIGURE 5. SUPPLY CURRENT vs SUPPLY VOLTAGE

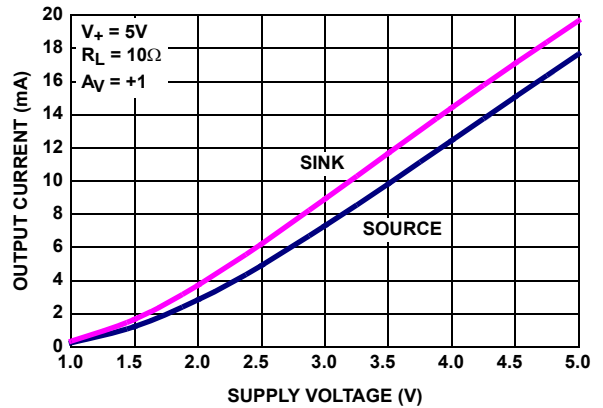

FIGURE 6. OUTPUT SHORT CIRCUIT CURRENT

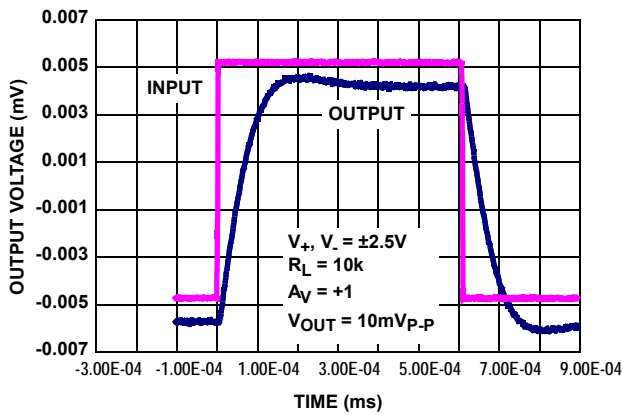

FIGURE 7. SMALL SIGNAL TRANSIENT RESPONSE

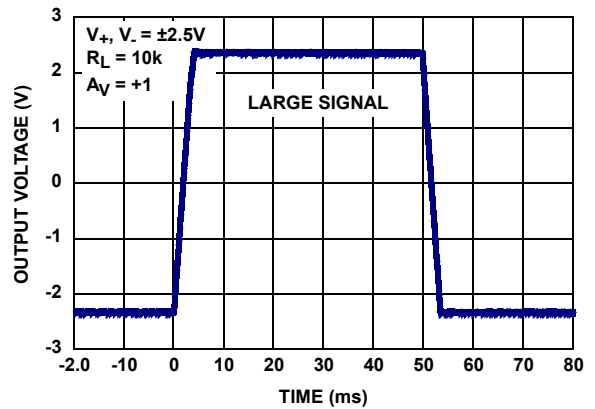

FIGURE 8. LARGE SIGNAL TRANSIENT RESPONSE

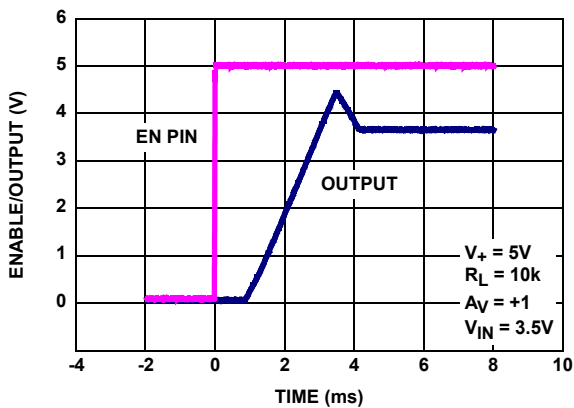

FIGURE 9. ENABLE TO OUTPUT DELAY TIME

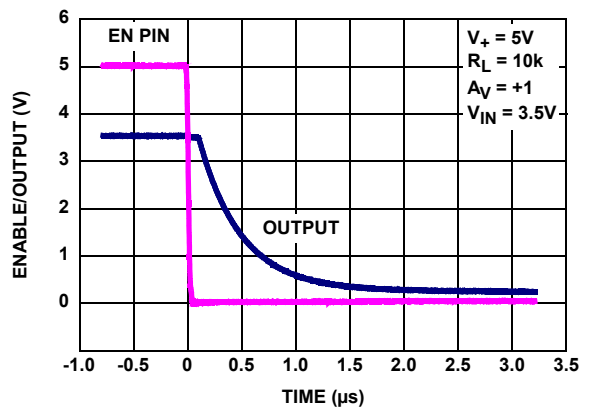

FIGURE 10. DISABLE TO OUTPUT DELAY TIME

Typical Performance Curves $V_+ = 5V$, $V_- = 0V$, $V_{CM} = 2.5V$, Unless Otherwise Specified. (Continued)

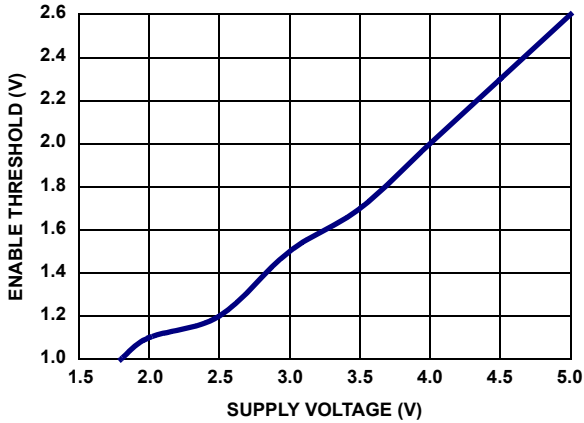

FIGURE 11. ENABLE THRESHOLD VOLTAGE vs SUPPLY VOLTAGE

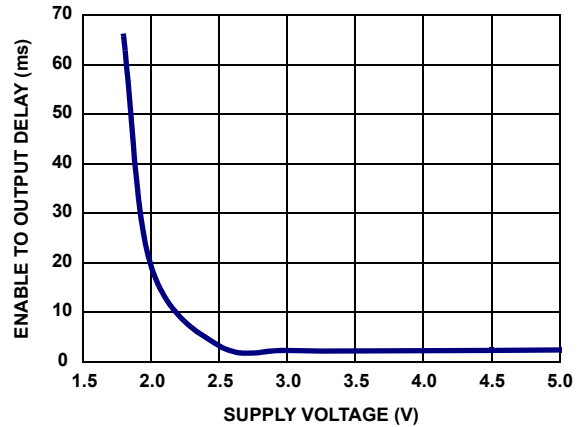

FIGURE 12. ENABLE TO OUTPUT DELAY TIME vs SUPPLY VOLTAGE

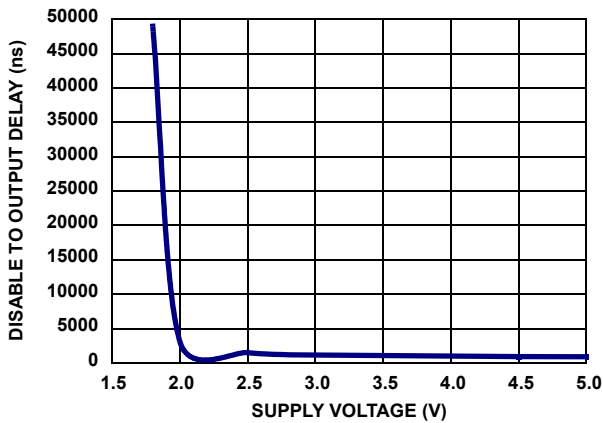

FIGURE 13. ENABLE LOW TO OUTPUT TURN-OFF TIME vs SUPPLY VOLTAGE

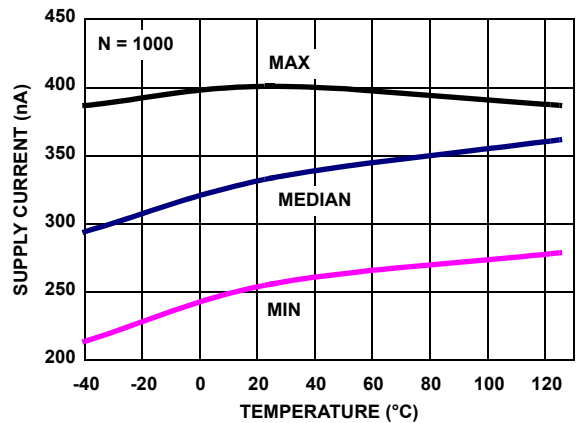

FIGURE 14. SUPPLY CURRENT ENABLED vs TEMPERATURE, $V_+ = 5V$, $V_- = 0V$

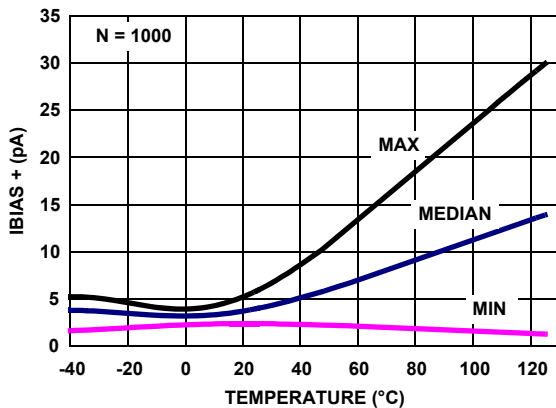

FIGURE 15. IBIAS+ vs TEMPERATURE $V_+ = 5V$

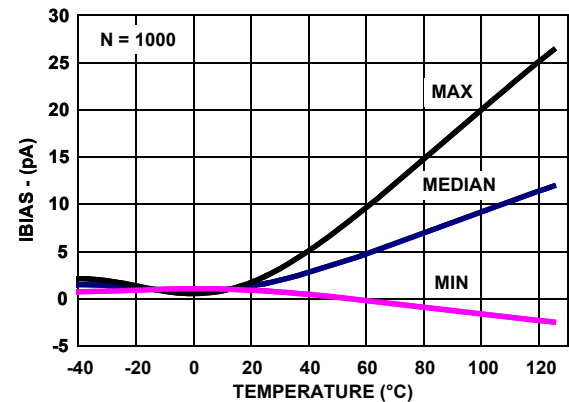

FIGURE 16. BIAS vs TEMPERATURE, $V_+ = 2.4V$

Typical Performance Curves $V_+ = 5V$, $V_- = 0V$, $V_{CM} = 2.5V$, Unless Otherwise Specified. (Continued)

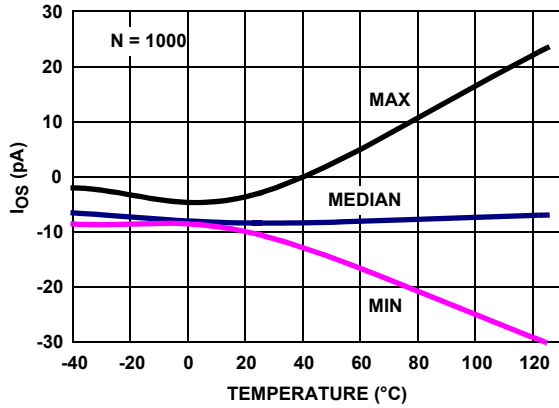

FIGURE 17. I_{OS} vs TEMPERATURE, $V_+ = 5V$

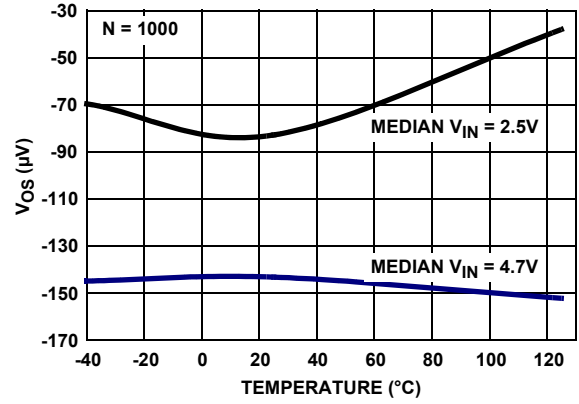

FIGURE 18. V_{OS} vs TEMPERATURE, $V_+ = 5V$, $V_{IN} = 2.5V, 4.7V$

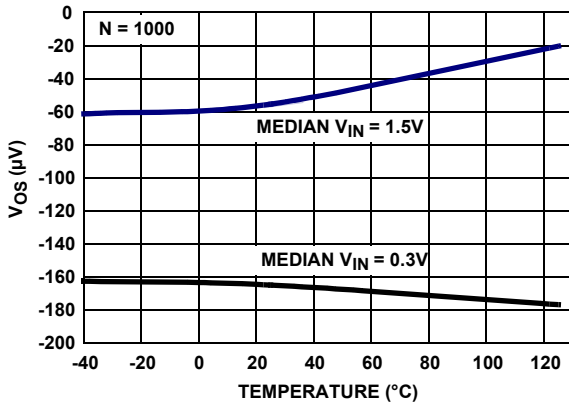

FIGURE 19. V_{OS} vs TEMPERATURE, $V_+ = 1.8V$, $V_{IN} = 1.5V, 0.3V$

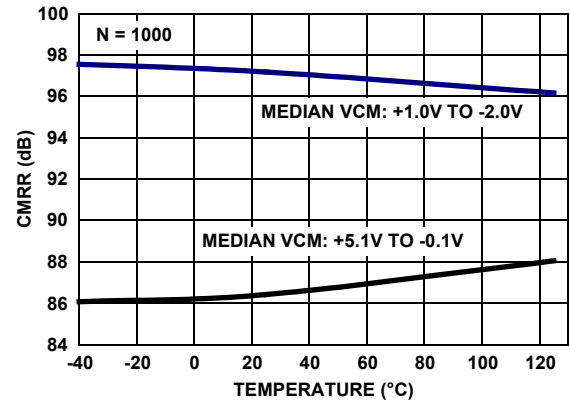

FIGURE 20. CMRR vs TEMPERATURE, $V_{CM} = +1.0V$ TO $-2.0V$, $+5.1V$ TO $-0.1V$

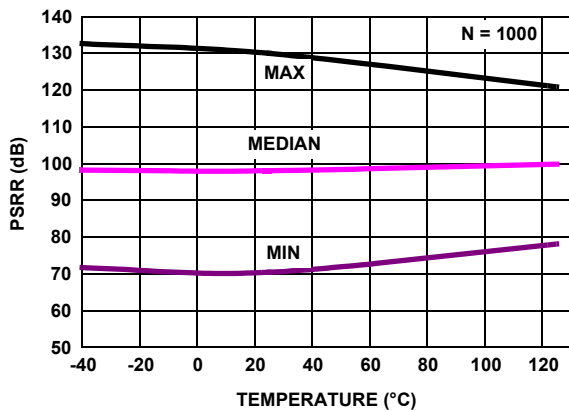

FIGURE 21. PSRR vs TEMPERATURE, $V_+, V_- = \pm 0.9V$ TO $\pm 2.5V$

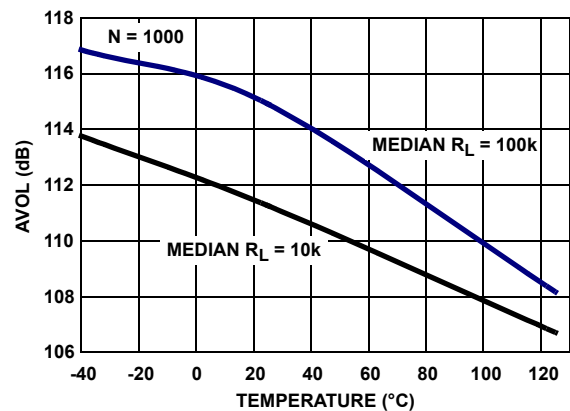

FIGURE 22. AVOL vs TEMPERATURE, $V_+ = 5V$

Typical Performance Curves $V_+ = 5V, V_- = 0V, V_{CM} = 2.5V$, Unless Otherwise Specified. (Continued)

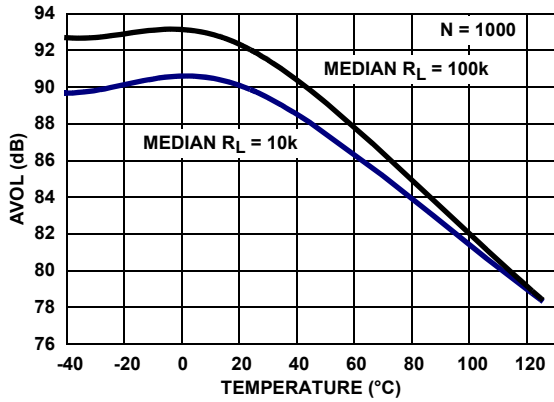

FIGURE 23. AVOL vs TEMPERATURE, $V_+ = 1.8V$

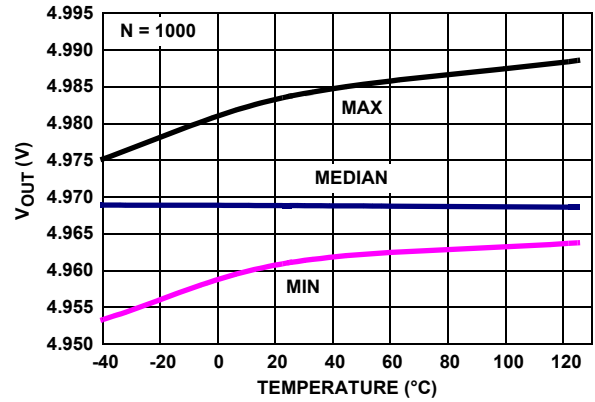

FIGURE 24. V_{OUT} HIGH vs TEMPERATURE, $V_+ = 5V, R_L = 100k$

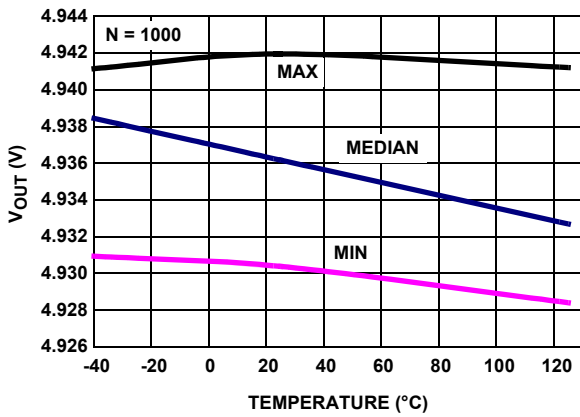

FIGURE 25. V_{OUT} HIGH vs TEMPERATURE, $V_+ = 5V, R_L = 10k$

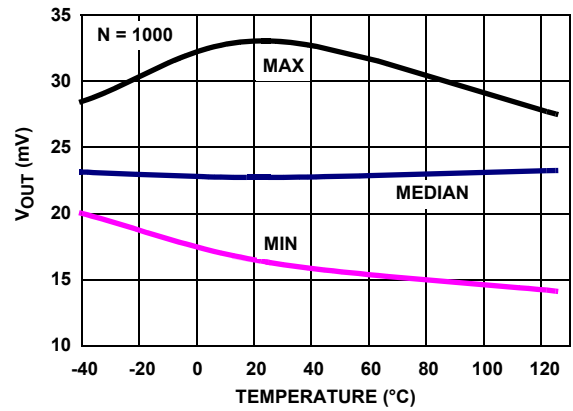

FIGURE 26. V_{OUT} LOW vs TEMPERATURE, $V_+, V_- = \pm 2.5V, R_L = 100k$

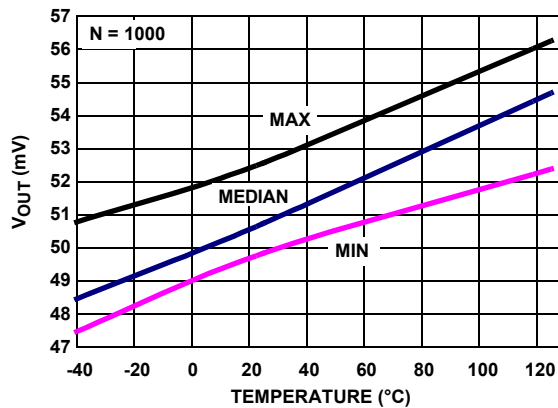
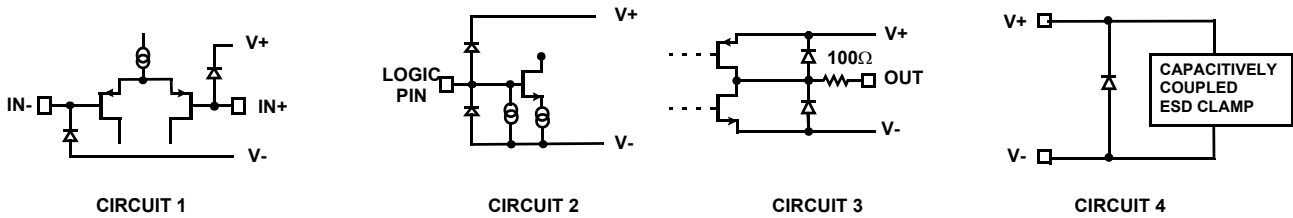

FIGURE 27. V_{OUT} LOW vs TEMPERATURE $V_+, V_- = \pm 2.5V, R_L = 10$

Pin Descriptions

ISL28194 (6 LD SOT-23)	ISL28194 (6 LD MTDFN)	PIN NAME	EQUIVALENT CIRCUIT	DESCRIPTION
1	4	OUT_A	Circuit 3	Amplifier output
2	2	V-	Circuit 4	Negative power supply
3	3	IN+	Circuit 1	Amplifier non-inverting input
4	1	IN-	Circuit 1	Amplifier inverting input
5	5	EN	Circuit 2	Amplifier enable pin; Logic "1" selects the enabled state, Logic "0" selects the disabled state.
6	6	V+	Circuit 4	Positive power supply



AC Test Circuits

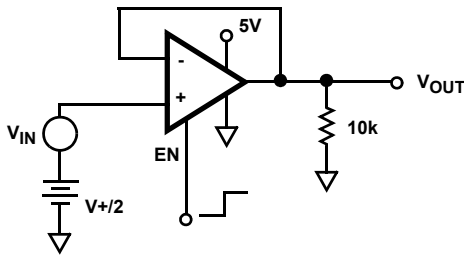

FIGURE 28. TEST CIRCUIT FOR $A_v = +1$

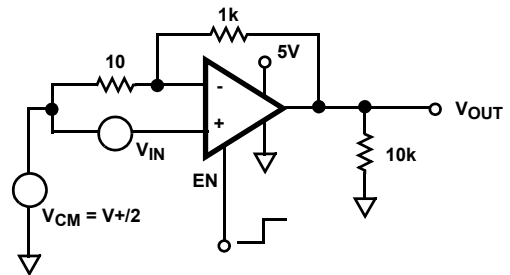

FIGURE 29. TEST CIRCUIT FOR $A_v = +101$

Applications Information

Introduction

The ISL28194 is a CMOS rail-to-rail input and output (RRIO) micropower operational amplifier. This device is designed to operate from single supply (1.8V to 5.5V) and has an input common mode range that extends to the positive rail and to the negative supply rail for true rail-to-rail performance. The CMOS output can swing within tens of millivolts to the rails. Featuring worst-case maximum supply current of 0.5μA, this amplifier is ideally suited for solar and battery-powered applications.

Input Protection

All input terminals have internal ESD protection diodes to both positive and negative supply rails, limiting the input voltage to within one diode beyond the supply rails. The ISL28194 has a maximum input differential voltage that includes the rails (-V - 0.5V to +V +0.5V).

Rail-to-Rail Output

A pair of complementary MOSFET devices are used to achieve the rail-to-rail output swing. The NMOS sinks current to swing the output in the negative direction. The PMOS sources current to swing the output in the positive direction. The ISL28194 will typically swing to within 40mV or less to either rail with a 100kΩ load (reference Figures 24 and 26).

Enable/Disable Feature

This part offers an EN pin that enables the device when pulled high. The enable threshold is referenced to the -V terminal and has a level proportional to the total supply voltage (reference Figure 11 for EN threshold vs supply voltage). The enable circuit has a delay time that changes as a function of supply voltage. Figures 12 and 13 show the effect of supply voltage on the enable and disable times. For supply voltages less than 3V, it is recommended that the user account for the increase enable/disable delay time.

In the disabled state (output in a high impedance state), the supply current is reduced to typical of only 2nA. By disabling the devices, multiple parts can be connected together as a MUX. In this configuration, the outputs are tied together in parallel and a channel can be selected by the EN pin. The EN pin should never be left floating. The EN pin should be connected directly to the V+ supply when not in use.

The loading effects of the feedback resistors of the disabled amplifier must be considered when multiple amplifier outputs are connected together.

Proper Layout Maximizes Performance

To achieve the maximum performance of the high input impedance, care should be taken in the circuit board layout. The PC board surface must remain clean and free of moisture to avoid leakage currents between adjacent traces. Surface coating of the circuit board will reduce surface moisture and provide a humidity barrier, reducing parasitic resistance on the board. When input leakage current is a concern, the use of guard rings around the amplifier inputs will further reduce leakage currents. Figure 30 shows a guard ring example for a unity gain amplifier that uses the low impedance amplifier output at the same voltage as the high impedance input to eliminate surface leakage. The guard ring does not need to be a specific width, but it should form a continuous loop around both inputs. For further reduction of leakage currents, components can be mounted to the PC board using Teflon standoff insulators.

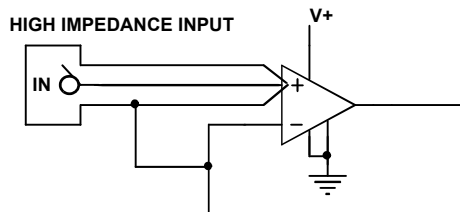

FIGURE 30. GUARD RING EXAMPLE FOR UNITY GAIN AMPLIFIER

Power Dissipation

It is possible to exceed the +150°C maximum junction temperatures under certain load and power-supply conditions. It is therefore important to calculate the maximum junction temperature (T_{JMAX}) for all applications to determine if power supply voltages, load conditions, or package type need to be modified to remain in the safe operating area. These parameters are related in Equation 1:

$$T_{JMAX} = T_{MAX} + (\theta_{JA} \times PD_{MAXTOTAL}) \quad (EQ. 1)$$

where:

- $PD_{MAXTOTAL}$ is the sum of the maximum power dissipation of each amplifier in the package (PD_{MAX})
- PD_{MAX} for each amplifier can be calculated as shown in Equation 2:

$$PD_{MAX} = 2 \times V_S \times I_{SMAX} + (V_S - V_{OUTMAX}) \times \frac{V_{OUTMAX}}{R_L} \quad (EQ. 2)$$

where:

- T_{MAX} = Maximum ambient temperature
- θ_{JA} = Thermal resistance of the package
- PD_{MAX} = Maximum power dissipation of 1 amplifier
- V_S = Supply voltage (Magnitude of V_+ and V_-)
- I_{MAX} = Maximum supply current of 1 amplifier
- V_{OUTMAX} = Maximum output voltage swing of the application
- R_L = Load resistance

© Copyright Intersil Americas LLC 2007-2014. All Rights Reserved.

All trademarks and registered trademarks are the property of their respective owners.

For additional products, see www.intersil.com/en/products.html

Intersil products are manufactured, assembled and tested utilizing ISO9001 quality systems as noted in the quality certifications found at www.intersil.com/en/support/qualandreliability.html

Intersil products are sold by description only. Intersil may modify the circuit design and/or specifications of products at any time without notice, provided that such modification does not, in Intersil's sole judgment, affect the form, fit or function of the product. Accordingly, the reader is cautioned to verify that datasheets are current before placing orders. Information furnished by Intersil is believed to be accurate and reliable. However, no responsibility is assumed by Intersil or its subsidiaries for its use; nor for any infringements of patents or other rights of third parties which may result from its use. No license is granted by implication or otherwise under any patent or patent rights of Intersil or its subsidiaries.

For information regarding Intersil Corporation and its products, see www.intersil.com

Ultra Thin Dual Flat No-Lead Plastic Package (UTDFN)

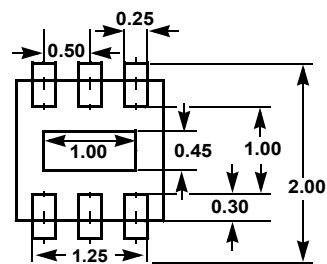
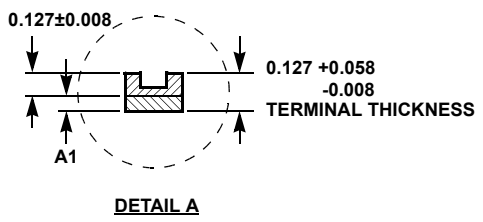
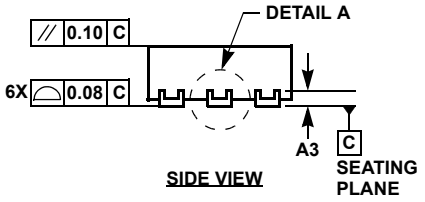
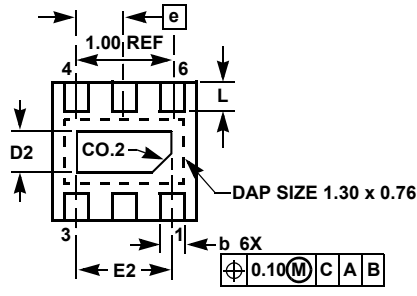
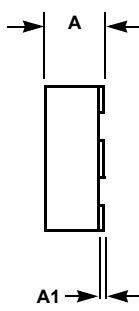
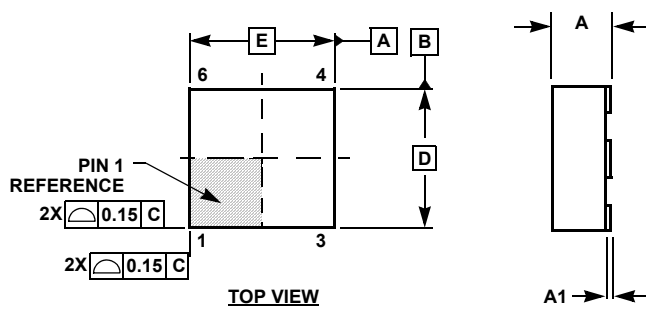

L6.1.6x1.6A

6 LEAD ULTRA THIN DUAL FLAT NO-LEAD PLASTIC PACKAGE

SYMBOL	MILLIMETERS			NOTES
	MIN	NOMINAL	MAX	
A	0.45	0.50	0.55	-
A1	-	-	0.05	-
A3	0.127 REF			-
b	0.15	0.20	0.25	-
D	1.55	1.60	1.65	4
D2	0.40	0.45	0.50	-
E	1.55	1.60	1.65	4
E2	0.95	1.00	1.05	-
e	0.50 BSC			-
L	0.25	0.30	0.35	-

Rev. 1 6/06

NOTES:

1. Dimensions are in MM. Angles in degrees.
2. Coplanarity applies to the exposed pad as well as the terminals. Coplanarity shall not exceed 0.08mm.
3. Warpage shall not exceed 0.10mm.
4. Package length/package width are considered as special characteristics.
5. JEDEC Reference MO-229.
6. For additional information, to assist with the PCB Land Pattern Design effort, see Intersil Technical Brief TB389.

Package Outline Drawing

P6.064A

6 LEAD SMALL OUTLINE TRANSISTOR PLASTIC PACKAGE

Rev 0, 2/10

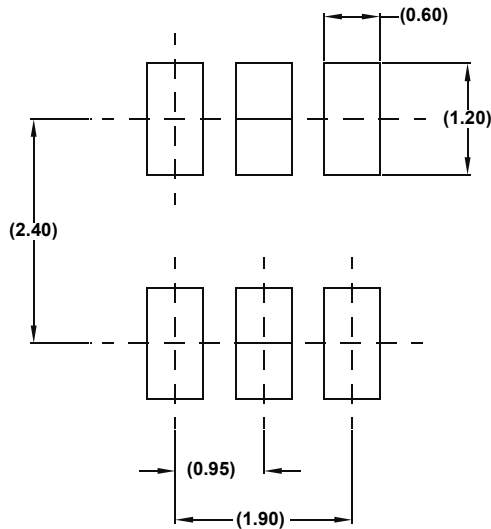
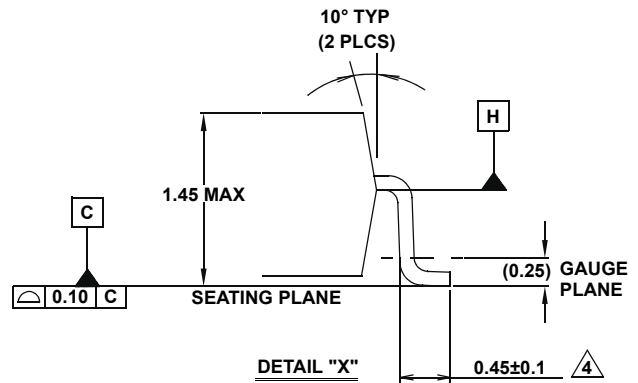
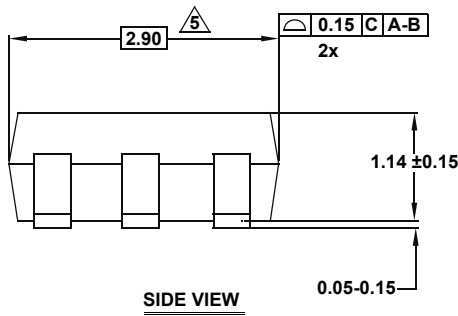
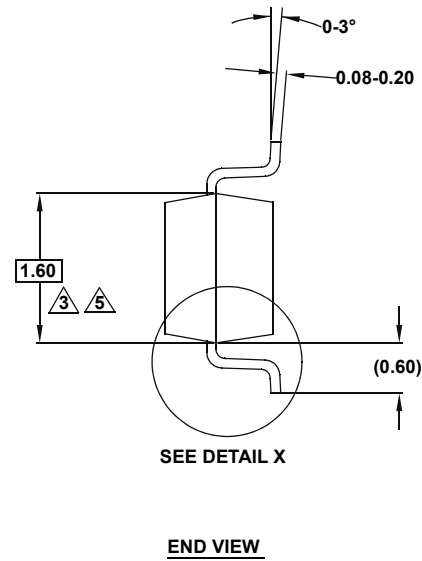
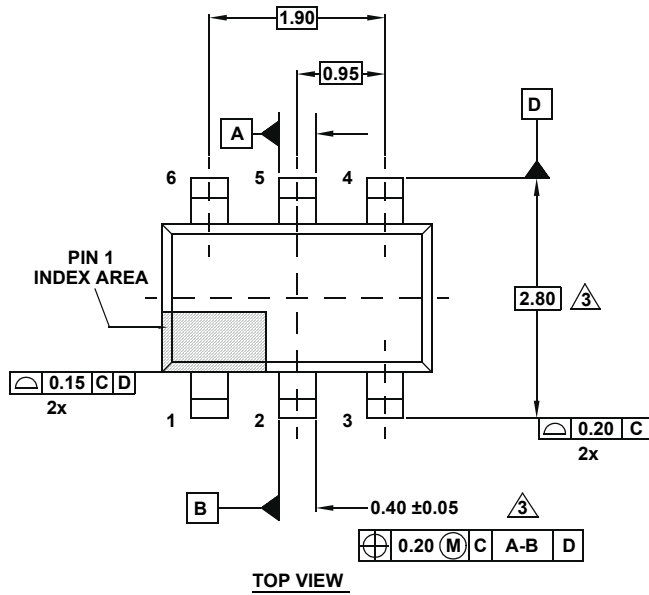

NOTES:

1. Dimensions are in millimeters.
Dimensions in () for Reference Only.
2. Dimensioning and tolerancing conform to ASME Y14.5M-1994.
3. Dimension is exclusive of mold flash, protrusions or gate burrs.
4. Foot length is measured at reference to gauge plane.
5. This dimension is measured at Datum "H".
6. Package conforms to JEDEC MO-178AA.

Mouser Electronics

Authorized Distributor

Click to View Pricing, Inventory, Delivery & Lifecycle Information:

[Renesas Electronics:](#)

[ISL28194FHZ-T7](#) [ISL28194FHZ-T7A](#) [ISL28194FRUZ-T7](#)