

## FEATURES

- UL60950 recognised
- RoHS compliant
- Efficiency from 80%
- Power density 1.31W/cm<sup>3</sup>
- Wide temperature performance at full 2 Watt load, -40°C to 85°C
- UL 94V-0 package material
- No heatsink required
- Industry standard pinout
- 3kVDC isolation (1 minute) 'Hi Pot Test'
- 5V, 12V, 15V & 24V inputs
- 5V, 9V, 12V, & 15V output
- Fully encapsulated with toroidal magnetics
- No electrolytic or tantalum capacitors
- Pin compatible with MEV1, MEV3 & NMV series

## PRODUCT OVERVIEW

The NMK series of industrial temperature range DC-DC converters, available in industry standard SIP packaging offers a power upgrade path from the 1W NMV series. The un-regulated NMK series has superior output voltage set point accuracy in conjunction with excellent load regulation for this converter type.

Unbalanced loading capabilities on dual output variants, all of the rated output power may be drawn from a single output<sup>3</sup>.

## SELECTION GUIDE

Order Code <sup>3</sup>	Nominal Input Voltage	Output Voltage	Output Current	Input Current at Rated Load	Load Regulation (Typ)	Load Regulation (Max)	Ripple & Noise (Typ) <sup>1</sup>	Ripple & Noise (Max) <sup>1</sup>	Efficiency (Min.)	Efficiency (Typ.)	Isolation Capacitance	MTTF <sup>2</sup>	
	V	V	mA	mA	%	%	mVp-p	mVp-p	%	%	pF	MIL. kHrs	Tel. kHrs
NMK0505SAC	5	5	400	470	5.7	7.3	24	40	80	83	28	3998	
NMK0509SAC	5	9	222	455	4.2	5.9	20	25	83	86	36	3718	
NMK0512SAC	5	12	167	450	3.8	5.1	18	20	83	87	36	3328	
NMK0515SAC	5	15	133	450	3.4	4.5	17	20	84	87	34	2855	
NMK1205SAC	12	5	400	200	4.2	4.9	25	30	80	83	33	3532	
NMK1209SAC	12	9	222	190	2.6	3.1	19	20	83	87	53	2417	
NMK1212SAC	12	12	167	190	2.4	2.9	17	23	85	88	62	2246	
NMK1215SAC	12	15	133	185	2.0	2.4	14	25	84	89	56	2020	
NMK1505SAC	15	5	400	158	4.3	5.5	34	55	81	84	37	2202	9857
NMK1509SAC	15	9	222	153	3	4	21	40	83	86	51	2478	11668
NMK1512SAC	15	12	167	150	2.5	3.5	20	40	84	87	63	1825	10324
NMK1515SAC	15	15	133	149	2.4	3.5	20	40	85	88	72	2220	13067
NMK2405SAC	24	5	400	99	4.2	5.5	42	70	80	84	41	1618	9838
NMK2409SAC	24	9	222	95	2.7	3.5	30	55	83	87	59	2032	12177
NMK2412SAC	24	12	167	94	2.1	3	29	55	84	88	77	1879	12287
NMK2415SAC	24	15	133	93	2.2	3	34	70	85	88	85	1558	11155
NMK0505SC	5	±5	±200	470	5	6.2	24	40	81	83	28	2324	
NMK0509SC	5	±9	±111	455	3.9	5.3	18	30	83	86	33	2158	
NMK0512SC	5	±12	±83	450	3.7	4.8	14	20	84	87	35	1931	
NMK0515SC	5	±15	±67	450	3.5	5.2	12	20	84	87	31	1655	
NMK1205SC	12	±5	±200	200	3.4	3.9	21	30	80	84	35	1952	
NMK1209SC	12	±9	±111	190	2.4	2.8	16	20	83	87	50	2021	
NMK1212SC	12	±12	±83	190	2.2	2.7	13	20	84	87	53	1821	
NMK1215SC	12	±15	±67	190	1.9	2.4	13	20	83	87	57	1574	
NMK1505SC	15	±5	±200	156	3.7	5	27	50	81	84	43	1466	8190
NMK1509SC	15	±9	±111	153	2.4	3.5	19	35	82	86	47	1957	11117
NMK1512SC	15	±12	±83	151	2.2	3	18	35	84	88	65	1515	10279
NMK1515SC	15	±15	±67	150	2.0	3	14	35	85	88	74	1404	11747
NMK2405SC	24	±5	±200	96	3.4	5	30	50	81	84	43	2268	12558
NMK2409SC	24	±9	±111	94	2.3	3.5	26	45	84	87	65	2571	12903
NMK2412SC	24	±12	±83	93	1.9	3	24	45	85	89	82	2134	12888
NMK2415SC	24	±15	±67	93	1.7	3	17	35	85	89	86	1581	12750

## INPUT CHARACTERISTICS

Parameter	Conditions	Min.	Typ.	Max.	Units
Voltage range	Continuous operation, 5V input types	4.5	5	5.5	V
	Continuous operation, 12V input types	10.8	12	13.2	
	Continuous operation, 15V input types	13.5	15	16.5	
	Continuous operation, 24V input types	21.6	24	26.4	
Reflected ripple current	NMK2405SAC, NMK2409SAC, NMK2405SC, NMK2409SC		14	25	mA p-p
	All other variants		7.5	15	

1. See Ripple & Noise characterisation method.

2. Calculated using MIL-HDBK-217 FN2 and Telcordia SR-332 calculation model with nominal input voltage at full load.

3. See application notes on page 3.

All specifications typical at T<sub>A</sub>=25°C, nominal input voltage and rated output current unless otherwise specified.



For full details go to [www.murata-ps.com/rohs](http://www.murata-ps.com/rohs)



**OUTPUT CHARACTERISTICS**

Parameter	Conditions	Min.	Typ.	Max.	Units
Rated Power	T <sub>A</sub> =-40°C to 85°C			2	W
Voltage Set Point Accuracy	See tolerance envelope				
Line regulation	High V <sub>IN</sub> to low V <sub>IN</sub>		1.05	1.2	%/%

**ABSOLUTE MAXIMUM RATINGS**

Lead temperature 1.5mm from case for 10 seconds	260°C
Input voltage V <sub>IN</sub> , NMK05 types	7V
Input voltage V <sub>IN</sub> , NMK12 types	15V
Input voltage V <sub>IN</sub> , NMK15 types	18V
Input voltage V <sub>IN</sub> , NMK24 types	28V

**ISOLATION CHARACTERISTICS**

Parameter	Conditions	Min.	Typ.	Max.	Units
Isolation test voltage	Flash tested for 1 minute	3000			VDC
Resistance	Viso= 1000VDC	10			GΩ

**GENERAL CHARACTERISTICS**

Parameter	Conditions	Min.	Typ.	Max.	Units
Switching frequency			60		kHz

**TEMPERATURE CHARACTERISTICS**

Parameter	Conditions	Min.	Typ.	Max.	Units
Specification	All output types	-40		85	°C
Storage		-50		125	
Case Temperature above ambient	5V output types & NMK1509SAC (Except NMK1505S(A)C & NMK2405S(A))			28	
	NMK1505S(A)C & NMK2405S(A)C			32	
Cooling	Free air convection			25	

**TEMPERATURE DERATING GRAPH**

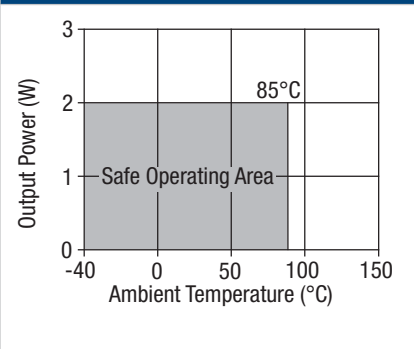

**TOLERANCE ENVELOPE**

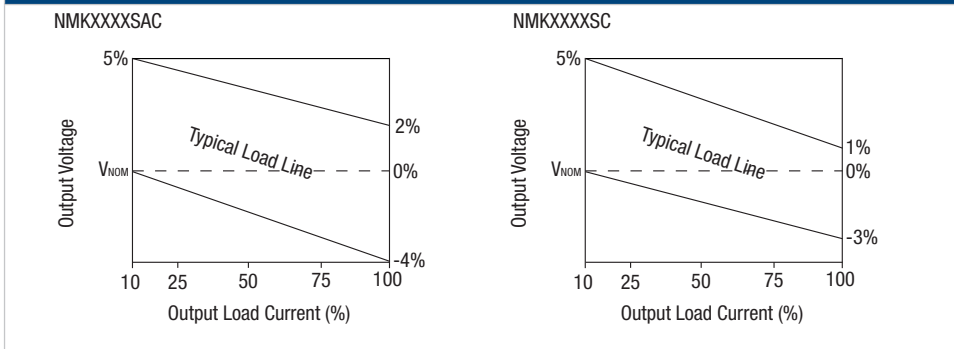

**TECHNICAL NOTES**

**ISOLATION VOLTAGE**

‘Hi Pot Test’, ‘Flash Tested’, ‘Withstand Voltage’, ‘Proof Voltage’, ‘Dielectric Withstand Voltage’ & ‘Isolation Test Voltage’ are all terms that relate to the same thing, a test voltage, applied for a specified time, across a component designed to provide electrical isolation, to verify the integrity of that isolation.

Murata Power Solutions NMK series of DC-DC converters are all 100% production tested at their stated isolation voltage. This is 3kVDC for 1 minute.

A question commonly asked is, “What is the continuous voltage that can be applied across the part in normal operation?”

The NMK series has been recognized by Underwriters Laboratory for functional insulation. Both input and output should normally be maintained within SELV limits i.e. less than 42.4V peak, or 60VDC. The isolation test voltage represents a measure of immunity to transient voltages and the part should never be used as an element of a safety isolation system. The part could be expected to function correctly with several hundred volts offset applied continuously across the isolation barrier; but then the circuitry on both sides of the barrier must be regarded as operating at an unsafe voltage and further isolation/insulation systems must form a barrier between these circuits and any user-accessible circuitry according to safety standard requirements.

**REPEATED HIGH-VOLTAGE ISOLATION TESTING**

It is well known that repeated high-voltage isolation testing of a barrier component can actually degrade isolation capability, to a lesser or greater degree depending on materials, construction and environment. The NMK series has toroidal isolation transformers, with no additional insulation between primary and secondary windings of enamelled wire. While parts can be expected to withstand several times the stated test voltage, the isolation capability does depend on the wire insulation. Any material, including this enamel (typically polyurethane) is susceptible to eventual chemical degradation when subject to very high applied voltages thus implying that the number of tests should be strictly limited. We therefore strongly advise against repeated high voltage isolation testing, but if it is absolutely required, that the voltage be reduced by 20% from specified test voltage.

This consideration equally applies to agency recognized parts rated for better than functional isolation where the wire enamel insulation is always supplemented by a further insulation system of physical spacing or barriers.

**SAFETY APPROVAL**

The NMK series has been recognised by Underwriters Laboratory (UL) to UL 60950 for functional insulation in a maximum ambient temperature of 85°C and/or case temperature limit of 130°C. Case temperature measured on the face opposite the pins. File number E151252 applies.

The NMK Series of converters are not internally fused so to meet the requirements of UL 60950 an anti-surge input line fuse should always be used as below:

- NMK05xxSC/SAC: 2A
- NMK12xxSC/SAC: 0.75A
- NMK15xxSC/SAC: 0.75A
- NMK24xxSC/SAC: 0.375A

**RoHS COMPLIANT INFORMATION**



This series is compatible with RoHS soldering systems with a peak wave solder temperature of 260°C for 10 seconds. The pin termination finish on the SIP package type is Tin Plate, Hot Dipped over Matte Tin with Nickel Preplate. The DIP types are Matte Tin over Nickel Preplate. Both types in this series are backward compatible with Sn/Pb soldering systems. For further information, please visit [www.murata-ps.com/rohs](http://www.murata-ps.com/rohs)

**APPLICATION NOTES**

**Minimum Load**

The minimum load to meet datasheet specification is 10% of the full rated load across the specified input voltage range. Lower than 10% minimum loading will result in an increase in output voltage, which may rise to typically double the specified output voltage if the output load falls to less than 5%.

**Unbalanced Load**

The NMK series offers unbalanced loading capabilities with up to the full 2W available from a single output. However, when operated in this mode there may be a slight performance decrease in efficiency and load regulation.

**APPLICATION NOTES (continued)**

**Ripple & Noise Characterisation Method**

All measurement to be taken with the following components connected to the UUT as detailed below.  
50 Ohm coax cable, solder connections one end, BNC plug at the other end.

C1	1µF X7R multilayer ceramic capacitor rated at minimum 3 x the output voltage of the UUT
C2	10µF tantalum capacitor rated at minimum 1.5 x the output voltage of the UUT with ESR of less than 100 milliohms at 100 kHz e.g. AVX TPS
C3	100nF multilayer ceramic capacitor, general purpose
R1	450 Ohm resistor, carbon film, ±1%
R2	50 Ohm BNC termination
T1	3T of the coax cable through a ferrite toroid eg Ferroxcube TN32/19/13-3E25
RLOAD	Resistive load at the UUT maximum rating. Connections via twisted wires.

**Differential Mode Noise Test Schematic**

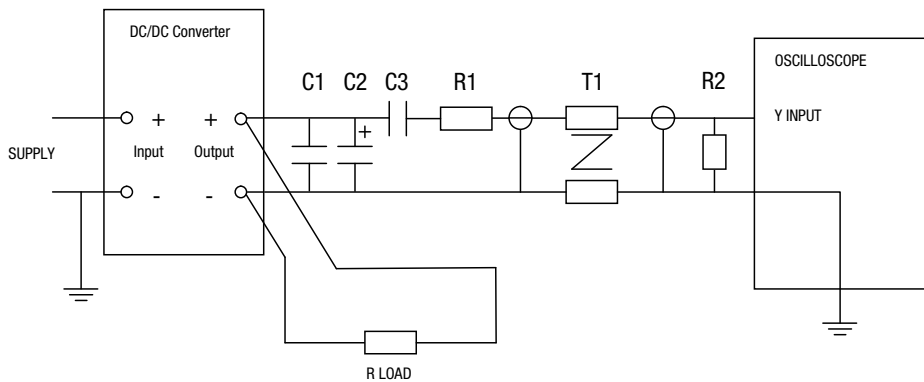

**EFFICIENCY VS LOAD**

**NMK05XXSAC**

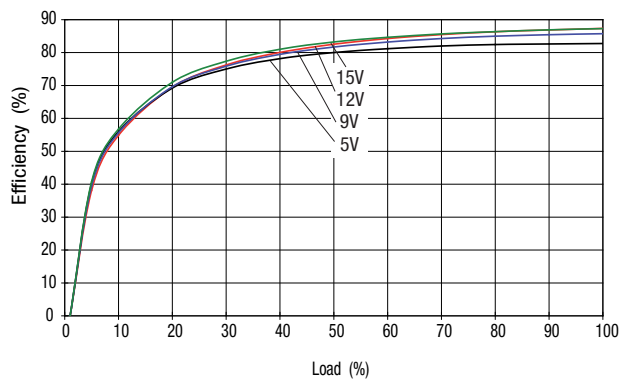

**NMK12XXSAC**

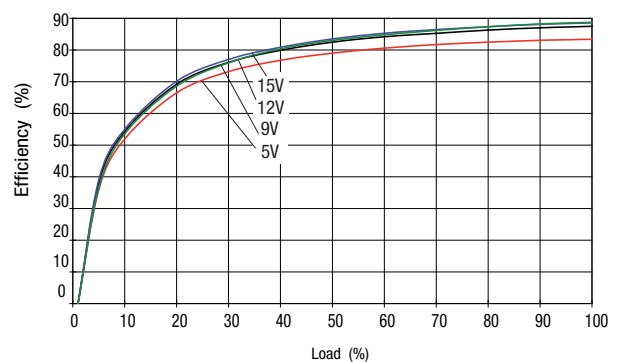

**EFFICIENCY VS LOAD (continued)**

**NMK15XXSAC**

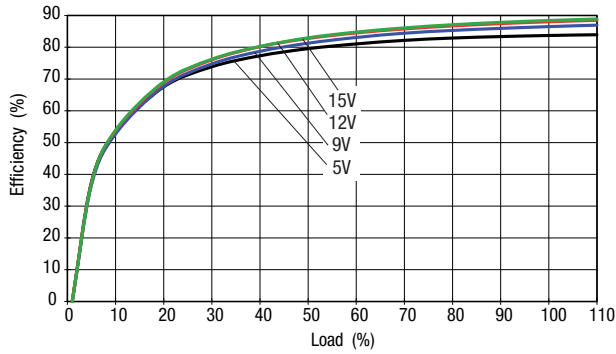

**NMK24XXSAC**

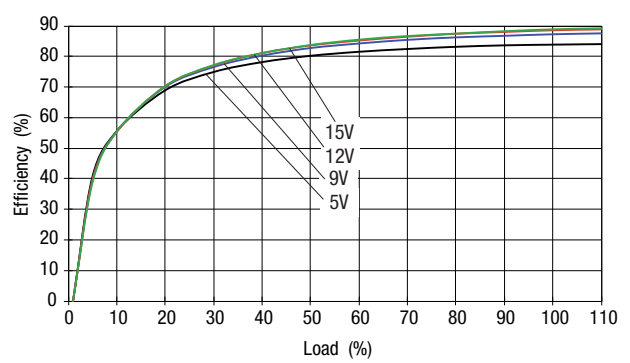

**NMK05XXSC**

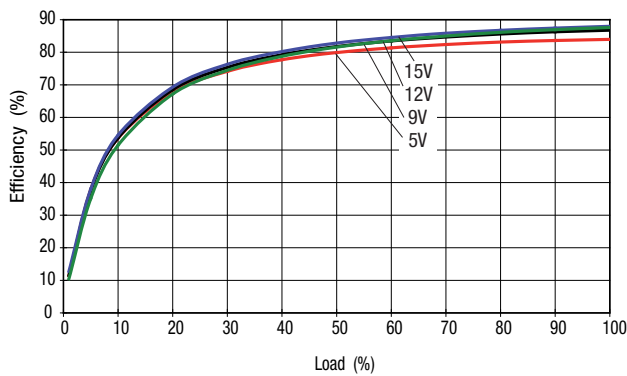

**NMK12XXSC**

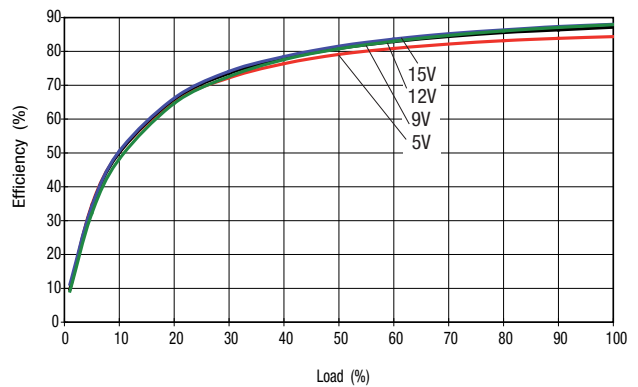

**NMK15XXSC**

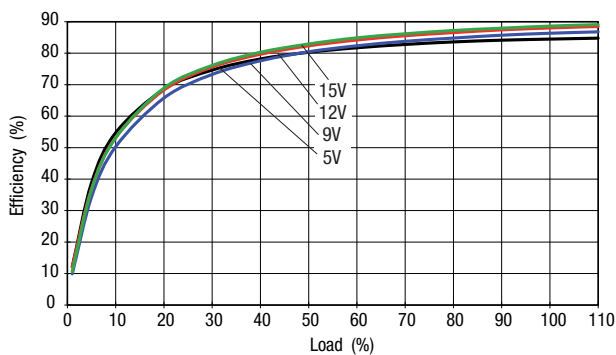

**NMK24XXSC**

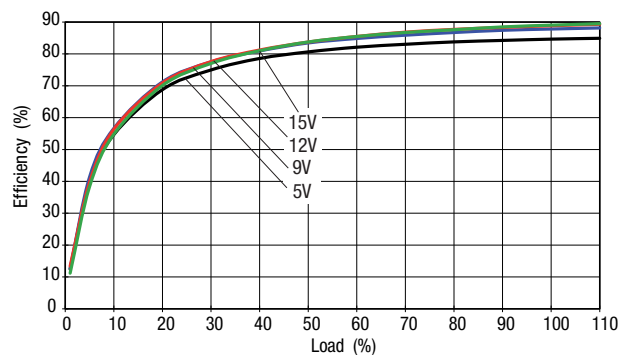

**PACKAGE SPECIFICATIONS**

**MECHANICAL DIMENSIONS**

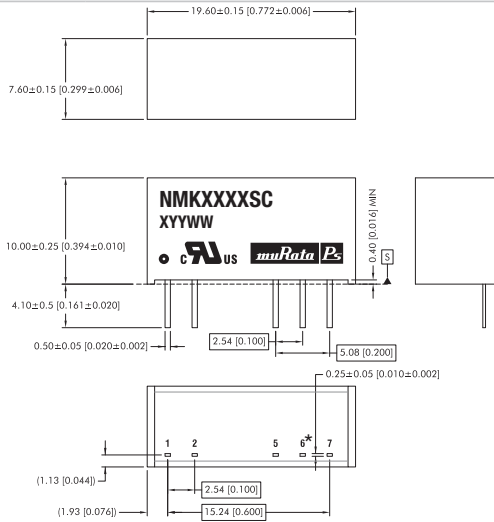

\* Pin not fitted on single output variants.

All dimensions in mm (inches) Controlling dimension is mm.

All pins on a 2.54 (0.100) pitch and within ±0.1 (0.004) of true position from pin 1 at seating plane 'S'

Weight: 2.8g

**PIN CONNECTIONS**

Single output variants		Dual output variants	
Pin	Function	Pin	Function
1	+VIN	1	+VIN
2	-VIN	2	-VIN
5	-VOUT	5	-VOUT
7	+VOUT	6	OV
		7	+VOUT

**RECOMMENDED FOOTPRINT DETAILS**

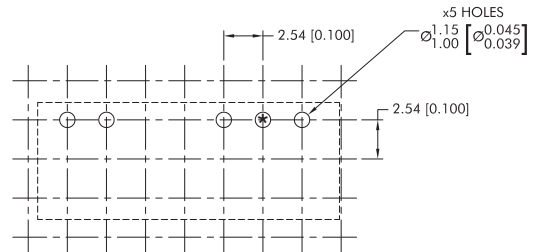

\* Hole not required for single output variants.

**TUBE OUTLINE DIMENSIONS**

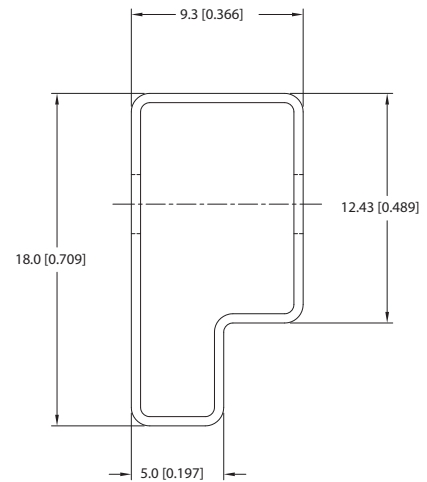

Unless otherwise stated all dimensions in mm (inches) ±0.5mm.

Tube length : 520mm ±2mm (20.47).

Tube Quantity : 25



This product is subject to the following **operating requirements** and the **Life and Safety Critical Application Sales Policy**:

Refer to: <http://www.murata-ps.com/requirements/>

Murata Power Solutions, Inc. makes no representation that the use of its products in the circuits described herein, or the use of other technical information contained herein, will not infringe upon existing or future patent rights. The descriptions contained herein do not imply the granting of licenses to make, use, or sell equipment constructed in accordance therewith. Specifications are subject to change without notice. © 2018 Murata Power Solutions, Inc.

# Mouser Electronics

Authorized Distributor

Click to View Pricing, Inventory, Delivery & Lifecycle Information:

## Murata:

[NMK1505SAC](#) [NMK1505SC](#) [NMK1509SAC](#) [NMK1509SC](#) [NMK1512SAC](#) [NMK1512SC](#) [NMK1515SAC](#)  
[NMK1515SC](#) [NMK2405SAC](#) [NMK2405SC](#) [NMK2409SAC](#) [NMK2409SC](#) [NMK2412SAC](#) [NMK2412SC](#)  
[NMK2415SAC](#) [NMK2415SC](#) [NMK1215SAC](#) [NMK0509SAC](#) [NMK0505SAC](#) [NMK1209SAC](#) [NMK1205SAC](#)  
[NMK1212SAC](#) [NMK0515SAC](#) [NMK0512SAC](#) [NMK0505SC](#) [NMK0509SC](#) [NMK0512SC](#) [NMK0515SC](#) [NMK1205SC](#)  
[NMK1209SC](#) [NMK1212SC](#) [NMK1215SC](#)