

PNEUMATIC LOGIC COMPONENTS

General characteristics

Operating fluid

- Compressed air or inert gas.

Conditions of use

- Operating pressure 2 at 8 bars (except for special conditions).
- Fluid: Filtered air to 50 microns - non lubricated.
- Operating temperature from - 5° C to + 50° C (under + 5° C the dew point must be below 10° C for the application).
- For optimum performance, the elements should be inter-connected by air supply tubing with an internal diameter ≥ at 2.5 mm.

Mounting recommendations

- The elements should be mounted and piped in a clean atmosphere in order to prevent any form of pollution entering the system.
- Minimum torque for element fixing screws: 5 cm/kg.
- maximum torque for element fixing screws: 10 cm/kg.

Characteristics common to all elements in the modular system

- The characteristics have been obtained with a supply pressure at 6 bars.
- The flow in NI/min is the number of litres of air at normal atmospheric pressure obtained with the output open to atmosphere and the supply pressure at 4 bars
- The consumption in NI/min is the number of litres of free air necessary for the unit to function.
- kV = the flow coefficient of the equipment.
- Mechanical life > 10⁷ operations.

flow graphs

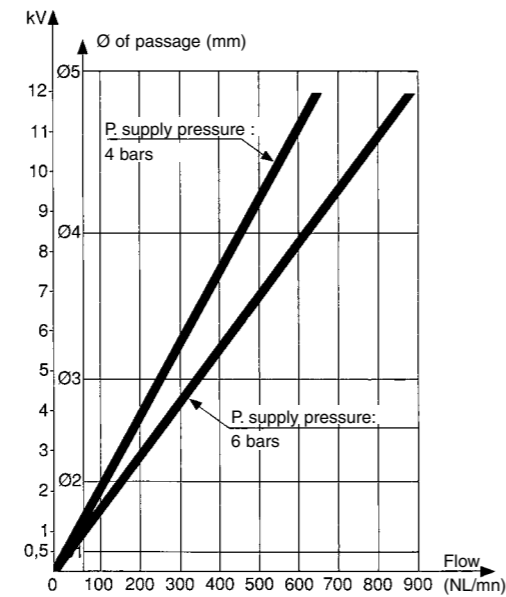

Sequencer modules

Operation results from the combination of a sequential cycle. A system comprises individual modules which are joined together by means of a sub-base. Each module has a memory which delivers an output signal and receives an input signal.

An indicator on each module allows the operator to monitor the progress of the cycle and identify quickly and easily any fault which may occur.

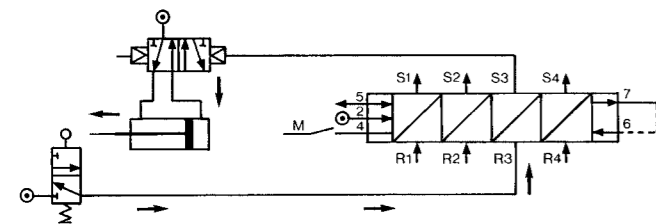

Operation results from the combination of three functions (memory, AND and OR) which constitute each module.

The memory activates the output and gives priority to the reset signal. The AND element ensures the transition to the next module but only if an input signal is present.

The OR element ensures the resetting of all previously operated modules

Function diagram

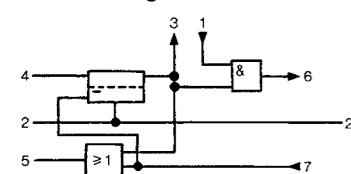

sequencer module with maintained reset

Brake

This maintains the memory spool in position only when the supply is lost.

Module with auto reset

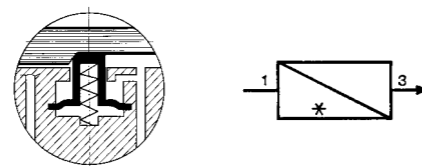

Brake

This returns the memory spool to the reset condition only when the supply is lost

Shift register

The general principle is to advance the sequencer step by command impulses to the inputs of the even steps, alternating with the command impulses to the inputs of the odd steps.

Used for example on a transfer machine to shift the information "bad component" collected at a test-test "n" steps further along the machine to a reject station.

Function diagram

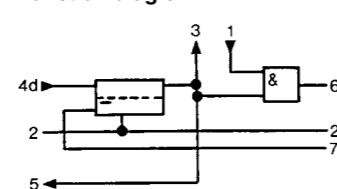

Auto reset sequencer module

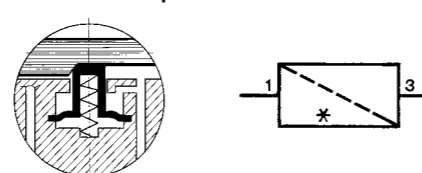

Sequencer modules

- > 100 % pneumatic
- > Ideal for a simple pneumatic sequence



Also available in **ATEX** version for use in potentially explosive atmospheres in accordance with 94/9/EC Directive

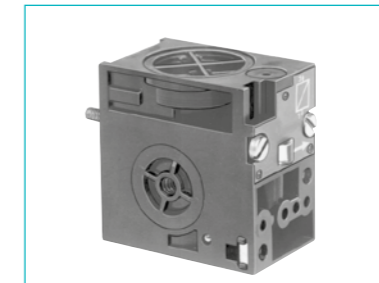

81 550 001

sequencer with 'maintain'

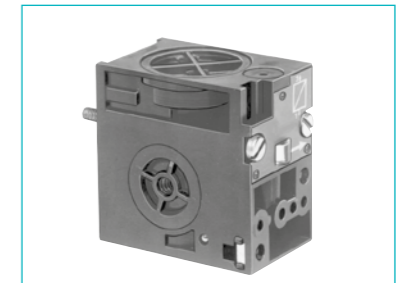

81 550 201

Reset to zero

81 550 401

with 'maintain'

81 550 601

Reset to zero

Versions sequencer shift register

Symbol

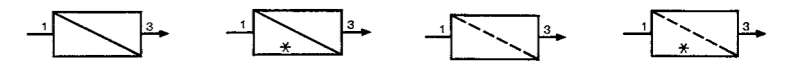

Characteristics

	bar	2 → 8	2 → 8	2 → 8	2 → 8
Operating pressure	mm	2.7	2.7	2.7	2.7
Orifice diameter	NI/min	150	150	150	150
Flow at 6 bars	°C	-5 → +50	-5 → +50	-5 → +50	-5 → +50
Operating temperature		•	•	•	•
Mechanical life 5 x 10 ⁶ at 6 bars		•	•	•	•
Connection - Sub-base page 26		•	•	•	•
Weight	g	70	70	70	70

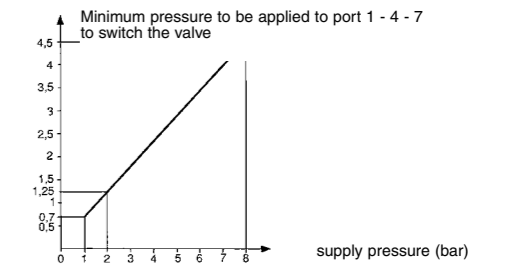

Principle of operation

(supplied without logic element. For choice of units see pages 46/47)

Sequencer module with maintained reset

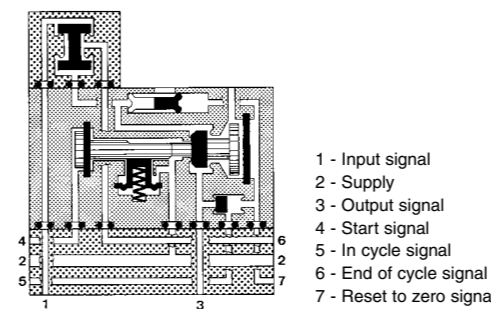

Shift register with maintained reset

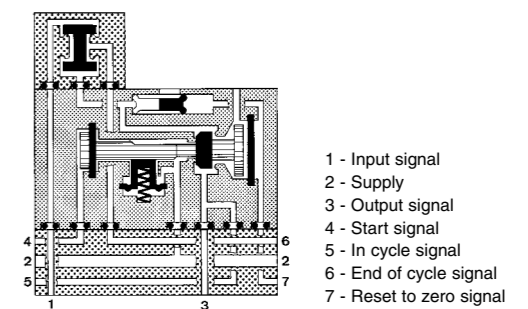

Dimensions

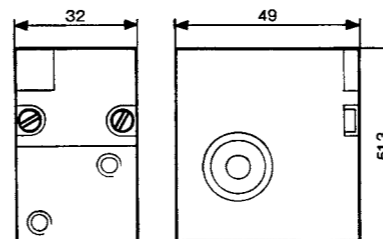

Mounting plan for sequencer

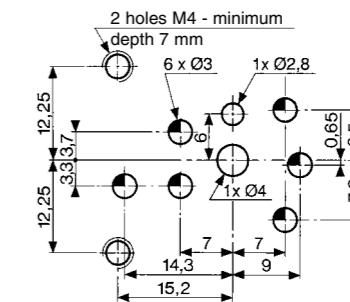

ATEX version products are available in the following catalogues: **Pneumatic products for explosive atmospheres** or on our website www.crouzet.com

Sequencer sub-bases

Also available in **ATEX** version for use in potentially explosive atmospheres in accordance with 94/9/EC Directive

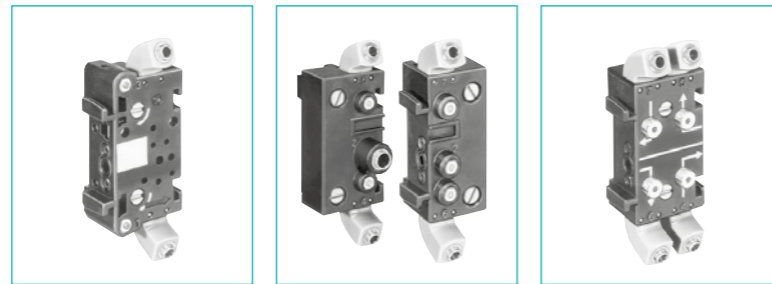

81 551 101 Sub-base (DIN oméga)
 81 552 101 End bases - one pair
 81 552 601 Diversion base

Versions Front connecting (DIN-omega)
 Rear connecting (with clips)

Characteristics

Sub-bases (fitted)	Rotatable connectors			
Operating temperature	°C	-5 → +50	-5 → +50	-5 → +50
Weight	g	55	135	60

Sequencer connections

Front connecting

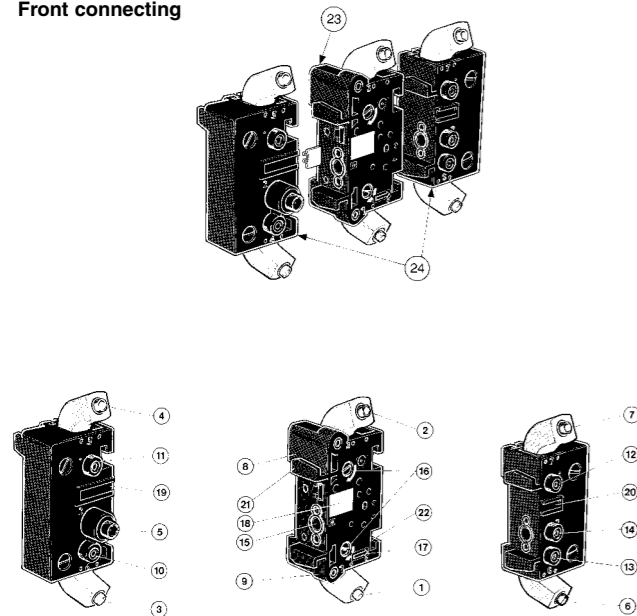

- 1 - Input port (green port 1) Ø 4
- 2 - Output port (red port 1) Ø 4
- 3 - Input port, cycle start (green port 1) Ø 4
- 4 - Output port, in-cycle signal (red port 1) Ø 4
- 5 - Output port, cycle end (red port 6) Ø 4
- 6 - Output port, cycle end (red port 6) Ø 4
- 7 - Input port, reset to zero (green port 7) Ø 4
- 8 - Output indicator (red)
- 9 - Input indicator (green)
- 10 - Cycle start indicator at port 4 (green)
- 11 - In-cycle indicator at port 5 (red)
- 12 - Input indicator at port 7 (green)
- 13 - End of cycle indicator at port 6 (red)
- 14 - Supply indicator at port 2 (yellow)
- 15 - Interconnecting ports
- 16 - Fixing screws
- 17 - Engraved arrow to indicate direction of sequence
- 18 - Marking tag
- 19 - Marking tag position
- 20 - Marking tag position
- 21 - Mounting tongue
- 22 - Mounting groove
- 23 - Sub-base
- 24 - End bases

Dimensions

Front connecting

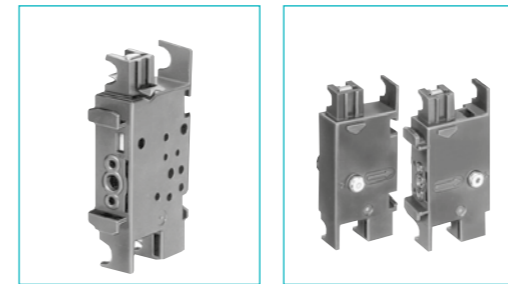
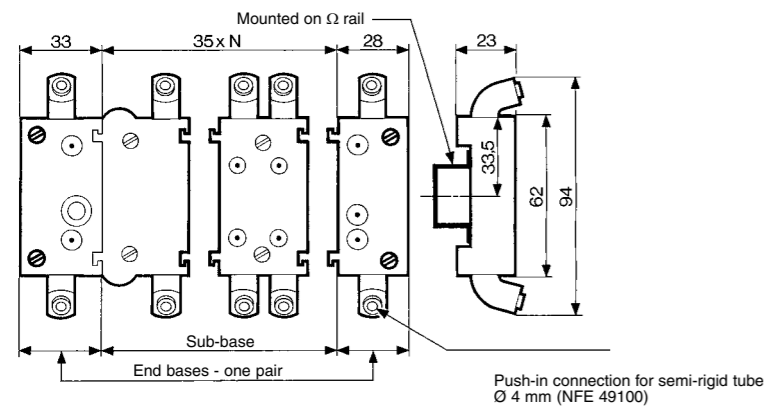

81 551 001 Sub-base (with clips)
 81 552 001 End bases - one pair

Operating temperature	°C	-5 → +50	-5 → +50
Weight	g	40	120

Rear connecting

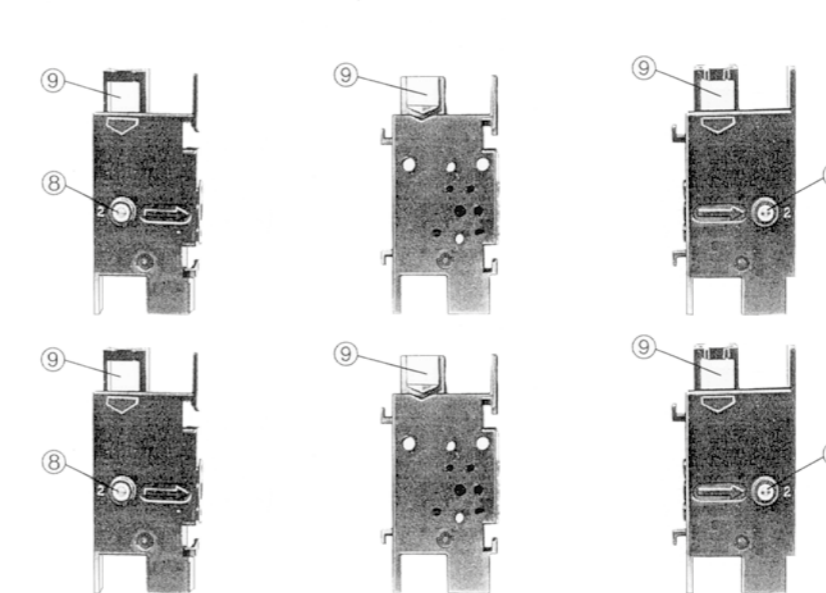

- 1 - Input port (marked port 1)
- 2 - Supply port (Port 2)
- 3 - Output port (Port 3)
- 4 - Cycle start signal port (Port 4)
- 5 - In-cycle signal port (Port 5)
- 6 - End of cycle signal port (Port 6)
- 7 - Reset to zero signal port (Port 7)
- 8 - Indicator at supply port
- 9 - Marking area

Rear connecting

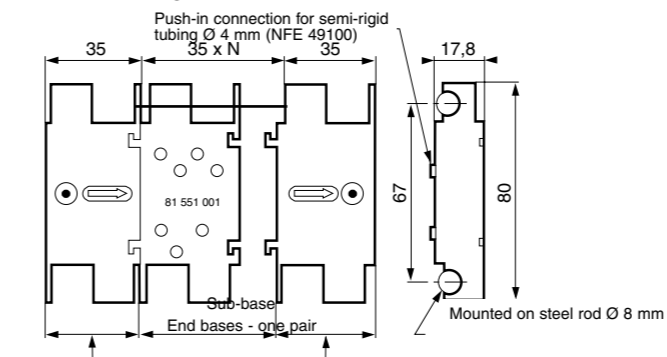

ATEX version products are available in the following catalogues: **Pneumatic products for explosive atmospheres** or on our website www.crouzet.com

Logic elements

- › Performs "combined" Pneumatic
- › Easy to use

Also available in **ATEX** version for use in potentially explosive atmospheres in accordance with 94/9/EC Directive

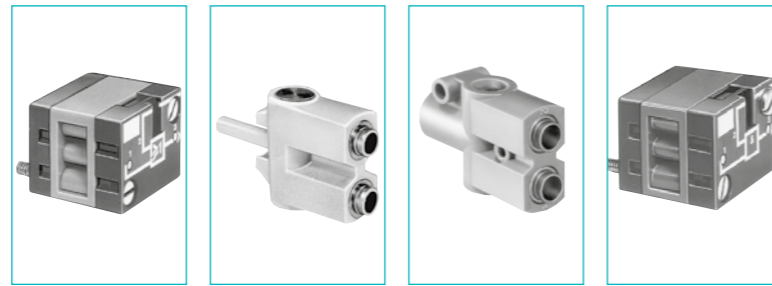

Functions	OR	81 521 501	81 540 001	81 540 005	81 522 501
	AND	—	—	—	—
	YES	—	—	—	—
	NO	—	—	—	—
Version		On Sub-base page 4/14-4/15	Plug-in Ø 4	Plug-in Ø 6	On Sub-base page 4/14-4/15

Symbol



Characteristics

Push-in connection for semi-rigid tubing (NFE 49100)	Male/Female/Female Female/Female/Female	—	—	—	—
Colour		Blue	Blue	Blue	Green
Operating pressure	bar	2 → 8	2 → 8	2 → 8	2 → 8
Orifice diameter	mm	2.7	2.7	4	2.7
Flow at 6 bars	NI/min	170	170	200	170
Pressure indicator		•	—	—	•
Switching time	ms	—	—	—	—
Operating temperature	°C	-5 → +50	-5 → +50	-5 → +50	-5 → +50
Mechanical life	operations	>10 ⁷	>10 ⁷	>10 ⁷	>10 ⁷
Weight	g	25	12	25	25

Pilot/pressure curves

P.p : Pilot pressure
P.a : Supply pressure

Principle of operation

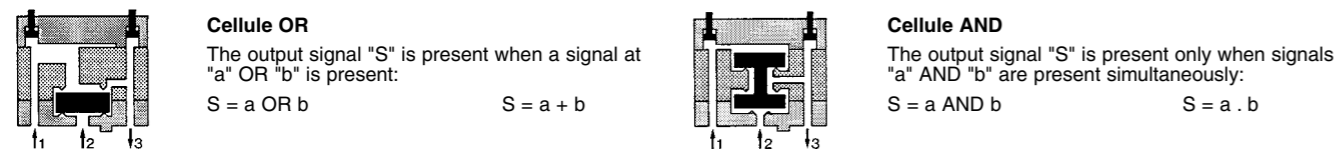

Dimensions

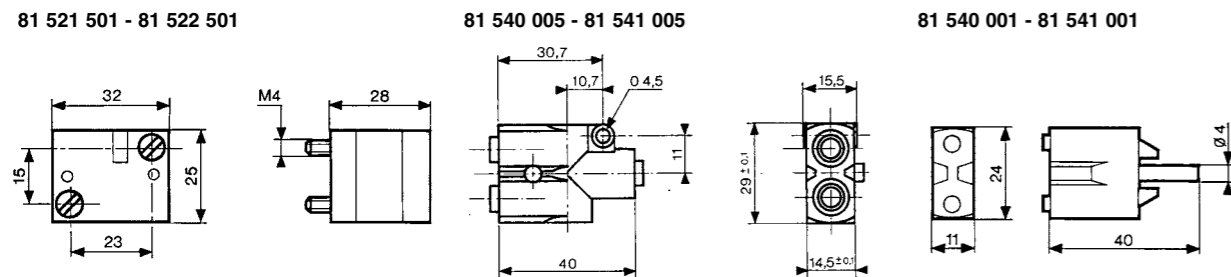

Other information

See pages 54/55 for mounting plan for logic elements.

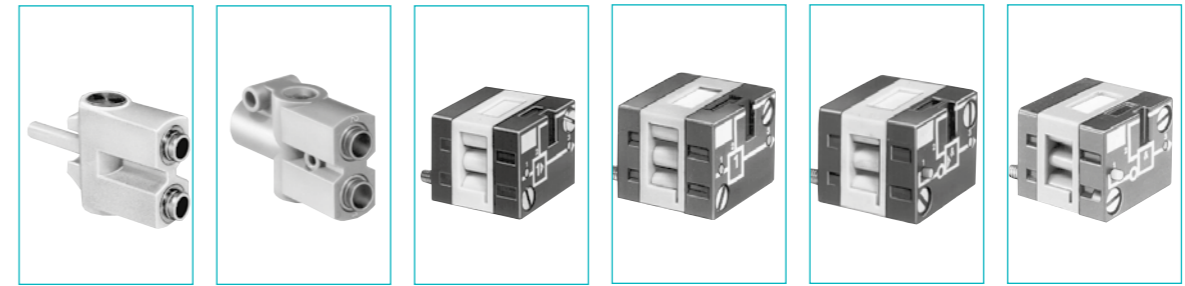

81 541 001	81 541 005	81 501 025	81 503 025	81 504 025	81 506 025
Plug-in Ø 4	Plug-in Ø 6	On sub-base page 36-37	Threshold On sub-base page 4/14-4/15	Threshold On sub-base page 4/14-4/15	Threshold On sub-base page 4/14-4/15

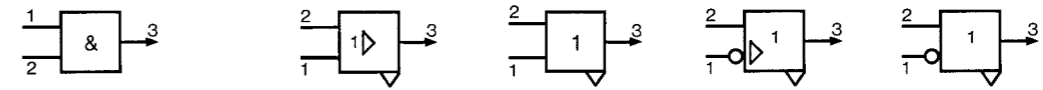

Ø 4 mm	—	—	—	—	—
Green	Ø 6 mm	Yellow	Orange	Light grey	Dark grey
2 → 8	Green	2 → 8	2 → 8	2 → 8	2 → 8
2.7	2 → 8	2 → 8	2 → 8	2 → 8	2 → 8
150	4	2.7	170	170	170
—	200	170	•	•	•
—	—	< 4	< 4	< 4	< 4
-5 → +50	-5 → +50	-5 → +50	-5 → +50	-5 → +50	-5 → +50
>10 ⁷	>10 ⁷	>10 ⁷	>10 ⁷	>10 ⁷	>10 ⁷
13	25	30	30	30	30

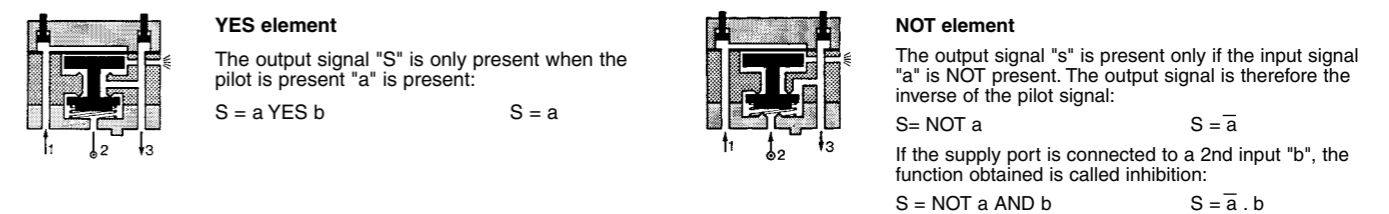
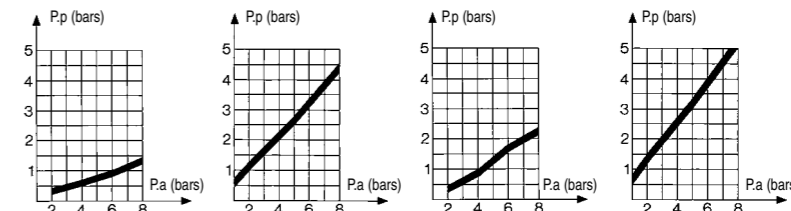

81 501 025 - 81 503 025 81 504 025 - 81 506 025

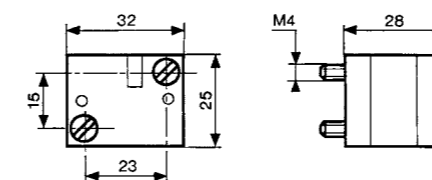

ATEX version products are available in the following catalogues: **Pneumatic products for explosive atmospheres** or on our website www.crouzet.com

Memory element

- > 100 % pneumatic
- > Bistable pneumatic

Also available in **ATEX** version for use in potentially explosive atmospheres in accordance with 94/9/EC Directive

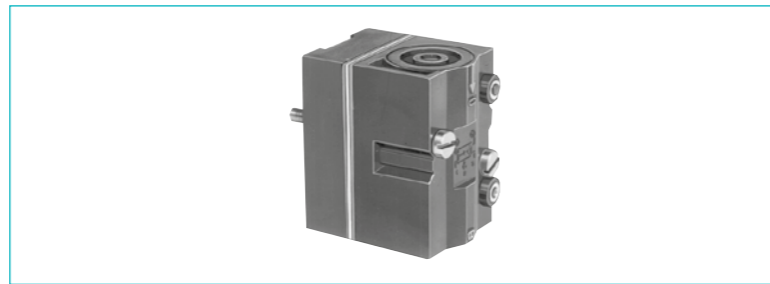

81 523 201
With pressure indicator

81 523 601
With pressure indicator and manual override

Version

Symbol

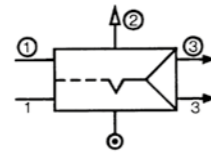

Characteristics

Colour		Black	Black
Operating pressure	bar	2 → 8	2 → 8
Orifice diameter	mm	2.7	2.7
Minimum memory pilot pressure	bar	2.5	2.5
Operating temperature	°C	-5 → +50	-5 → +50
Flow at 6 bars	NI/min	200	200
Connection - On sub-base page 4/14-4/15		•	•
Weight	g	90	90

Principle of operation

The function is that of a 4/2 valves. The appearance of signal "X1" causes the displacement of the slide valve. The output port "x" is then put under pressure. This state is remembered until the arrival of signal "X0". This signal reverses the slide valve, the output "x" is put under pressure. This state is likewise remembered. The output:

- "x" under pressure indicates that the information in the MEMORY is "X1",
- "x" under pressure indicates that the information in the MEMORY is "X0".

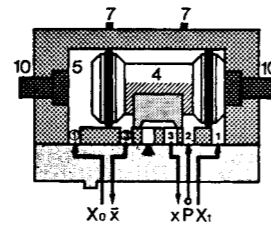

Dimensions

81 523 201 - 81 523 601

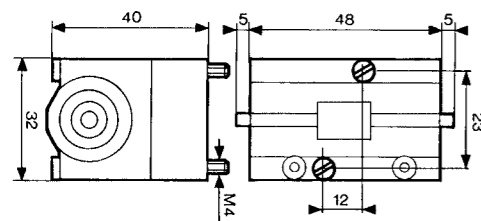

Dimensions of logic and memory elements

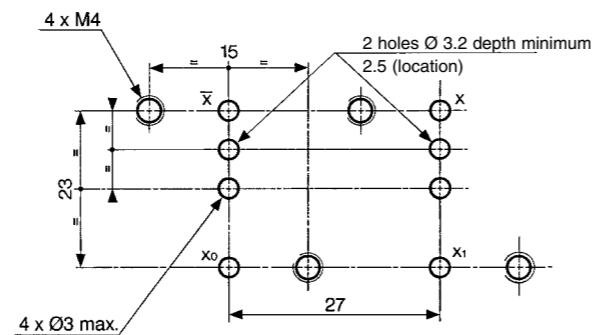

Viewed from above

ATEX version products are available in the following catalogues: **Pneumatic products for explosive atmospheres** or on our website www.crouzet.com

Timers fixed timing

- > Fixed 0.4 s

Also available in **ATEX** version for use in potentially explosive atmospheres in accordance with 94/9/EC Directive

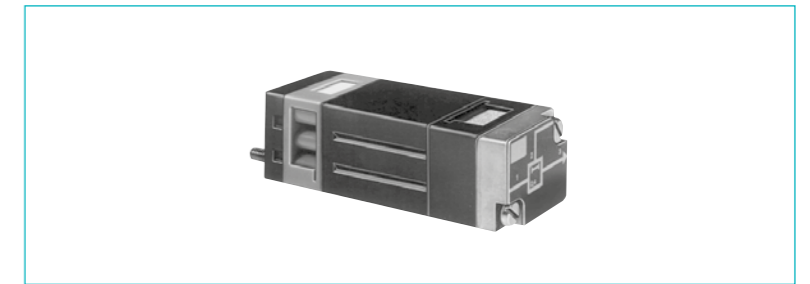

81 503 540
Positive output

Version

Symbol

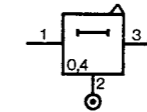

Characteristics

Timing	s	0.4
Operating pressure	bar	2 → 8
Flow at 6 bars	NI/min	170
Orifice diameter	mm	2.7
Accuracy	%	± 5
Min. reset time	s	<0.1
Connection - On sub-base page 36-37		•
Operating temperature	°C	-5 → +50
Mechanical life	operations	>10 ⁷
Weight	g	106

Principle of operation with positive output

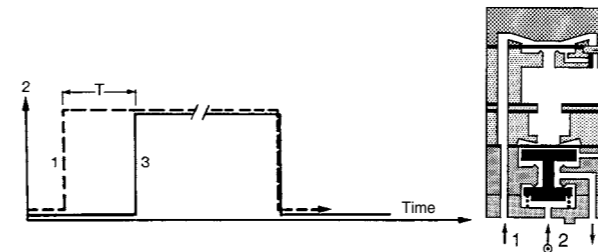

Dimensions

81 503 540

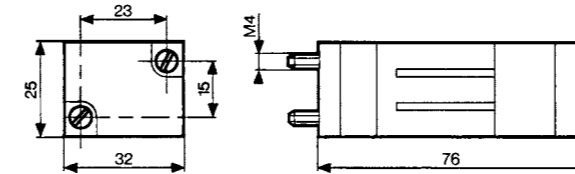

ATEX version products are available in the following catalogues: **Pneumatic products for explosive atmospheres** or on our website www.crouzet.com

Timers (with adjustable timing)

› 60 s adjustable (60 s max.)

Also available in **ATEX** version for use in potentially explosive atmospheres in accordance with 94/9/EC Directive

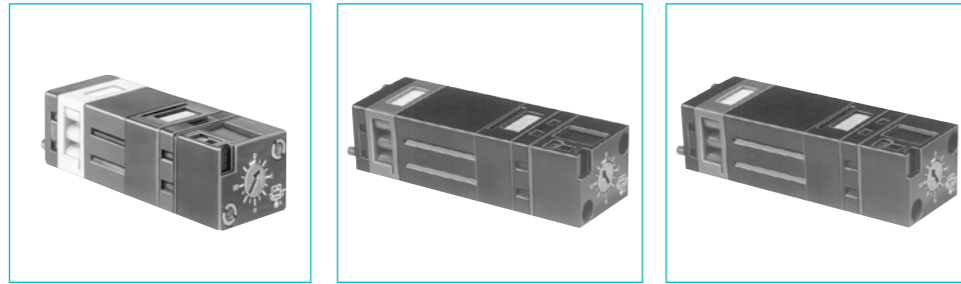

Function	81 503 710	81 506 710	81 503 720	81 506 720	81 503 725	81 506 725
positive	•	—	•	—	•	—
negative	—	•	—	•	—	•

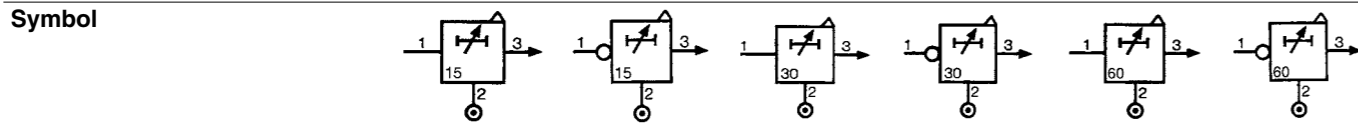

Characteristics

	81 503 710	81 506 710	81 503 720	81 506 720	81 503 725	81 506 725
Timing	s 0.1 → 15	s 0.1 → 15	s 0.1 → 30	s 0.1 → 30	s 0.1 → 60	s 0.1 → 60
Operating pressure	bar 2 → 8	bar 2 → 8	bar 2 → 8	bar 2 → 8	bar 2 → 8	bar 2 → 8
Flow at 6 bars	NI/min 170	NI/min 170	NI/min 170	NI/min 170	NI/min 170	NI/min 170
Orifice diameter	mm 2.7	mm 2.7	mm 2.7	mm 2.7	mm 2.7	mm 2.7
Accuracy	% ± 5	% ± 5	% ± 5	% ± 5	% ± 5	% ± 5
Min. reset time	s <0.1	s <0.1	s <0.1	s <0.1	s <0.1	s <0.1
Connection - On sub-base page 4/14-4/15	•	•	•	•	•	•
Operating temperature	°C -5 → +50	°C -5 → +50	°C -5 → +50	°C -5 → +50	°C -5 → +50	°C -5 → +50
Mechanical life	operations >10 ⁷	operations >10 ⁷	operations >10 ⁷	operations >10 ⁷	operations >10 ⁷	operations >10 ⁷
Weight	g 90	g 90	g 100	g 100	g 120	g 120

Accessories

	81 503 710	81 506 710	81 503 720	81 506 720	81 503 725	81 506 725
Panel mounting adaptor	79 451 698	79 451 698	79 451 903	79 451 903	—	—
Weight	g 53	g 53	g 53	g 53	—	—

Principle of operation
 The operation of these pneumatic timers is similar to that of electronic timers (circuit with capacitor/resistor) with positive output with negative output

Timing by charging of reservoir

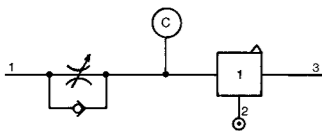

The reservoir fills via the flow restrictor until the switching point of the timer output is reached (positive or negative). The non-return valve allows the reservoir to be emptied rapidly for the next timing.

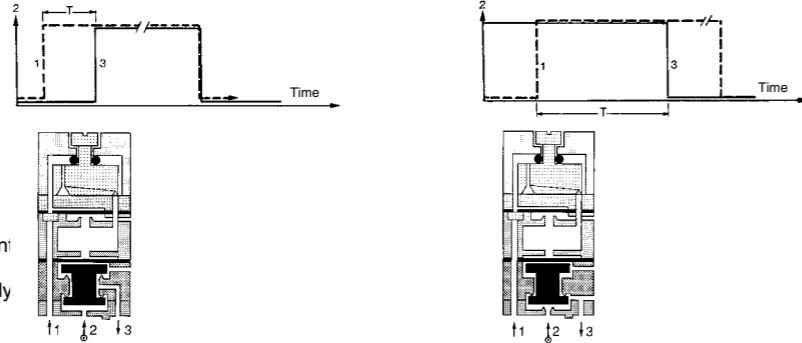

Dimensions

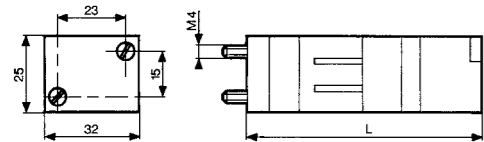

	L (mm)
81 503 710 - 81 506 710	78
81 503 720 - 81 506 720	92
81 503 725 - 81 506 725	125

Adaptor 79 451 ...

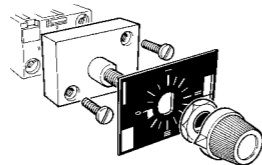
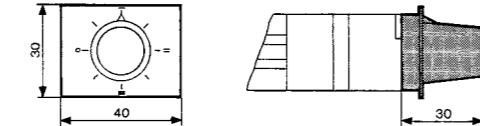

For panel mounting, a pre-drilled hole Ø 10.5 mm si required

ATEX version products are available in the following catalogues: **Pneumatic products for explosive atmospheres** or on our website www.crouzet.com

Timers

› Fixed and adjustable

Also available in **ATEX** version for use in potentially explosive atmospheres in accordance with 94/9/EC Directive



	Fixed	81 507 540	81 507 720	81 506 940
Single impulse generator	—	—	—	—
Adjustable frequency generator	Adjustable	—	—	—

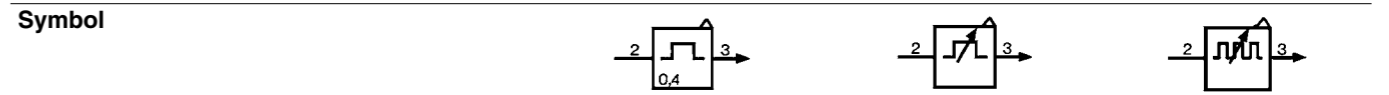

Characteristics

	81 507 540	81 507 720	81 506 940
Timing	s 0.4	s 0.1 → 30	s —
Frequency	Hz —	Hz —	Hz 0.02 → 8
Operating pressure	bar 2 → 8	bar 2 → 8	bar 2 → 8
Flow at 6 bars	NI/min 170	NI/min 170	NI/min 170
Orifice diameter	mm 2.7	mm 2.7	mm 2.7
Accuracy	% ± 5	% ± 5	% ± 5
Min. reset time	s <0.1	s <0.1	s <0.1
Connection - On sub-base page 4/14-4/15	•	•	•
Operating temperature	°C -5 → +50	°C -5 → +50	°C -5 → +50
Mechanical life	operations >10 ⁷	operations >10 ⁷	operations >10 ⁷
Weight	g 106	g 180	g 85

Accessories

	81 507 540	81 507 720	81 506 940
Panel mounting adaptators	—	79 451 904	79 451 905
Weight (g)	—	53	53

Principle of operation

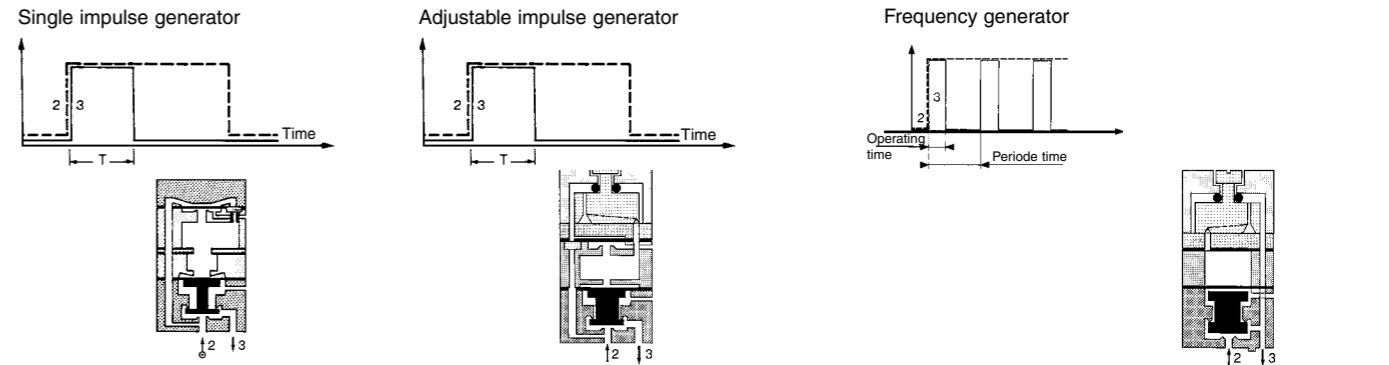

Dimensions

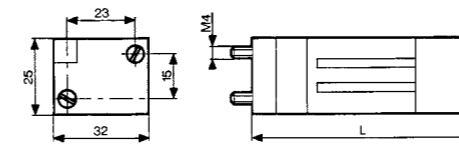

Part numbers	L (mm)
81 507 540	73
81 507 720	99
81 506 940	72

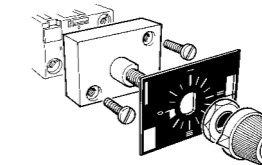
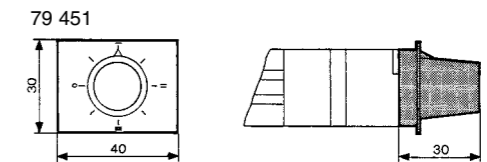

For panel mounting, a pre-drilled hole Ø 10.5 mm si required

ATEX version products are available in the following catalogues: **Pneumatic products for explosive atmospheres** or on our website www.crouzet.com

Timing Accessories

Also available in **ATEX** version for use in potentially explosive atmospheres in accordance with 94/9/EC Directive

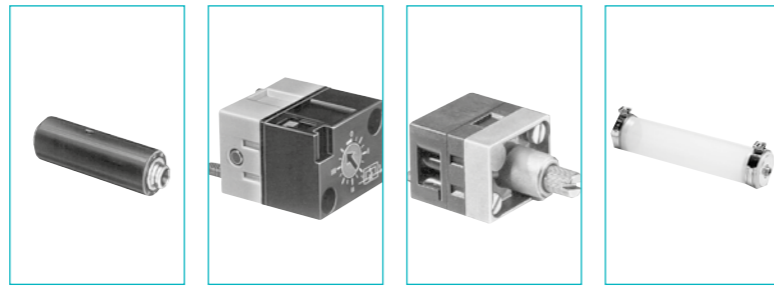

One-way in-line fixed flow restrictors	Flow at 4 bars Nm ³ /h	Ø orifice (mm)	Color	Part number	Weight (g)	Capacity (cm ³)
0.18 → 0.30	0.3	0.3	white	81 529 003	—	—
0.35 → 0.50	0.4	0.4	yellow	81 529 004	—	—
0.58 → 0.77	0.5	0.5	red	81 529 005	—	—
0.80 → 1.06	0.6	0.6	green	81 529 006	—	—
1.10 → 1.39	0.7	0.7	blue	81 529 007	—	—
1.45 → 1.65	0.8	0.8	grey	81 529 008	—	—
2.30 → 2.80	1	1	black	81 529 010	—	—
0.08 → 0.12	0.25	0.25	white	81 529 025	—	—
One-way adjustable flow restrictor	—	—	—	81 525 101	81 526 001	—
Capacity for timing	10 • 60 s	—	—	—	—	79 458 808

Symbol

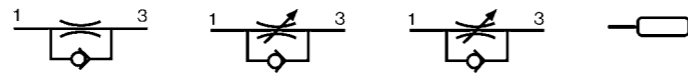

Characteristics

Free flow	Nl/min	Depending on orifice	30	200	—
Orifice diameter	mm	Depending on orifice	0 → 0.5	0 → 1.7	—
Operating pressure	bars	1 → 8	1 → 8	2 → 8	—
Timing	s	—	—	—	10 → 60
Capacity	cm ³	—	—	—	30
Connection	Sub-base page 4/14-4/15 Push-in connection for semi-rigid tubing (NFE 49100)	—	•	•	—
Operating temperature	°C	-5 → +50	-5 → +50	-5 → +50	-5 → +50
Weight	g	8	60	70	40

Connections

- For timing circuit
- One-way flow restrictor 81 525 1 - 81 529 0 (1)
- Reservoir 79 458 018 (2)
- Relay element 81 503 0 - 81 506 0 (3) page 4/6-4/7
- Sub-base page 4/14-4/15

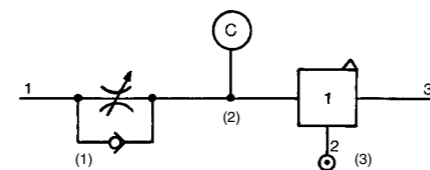

Principle of operation

One-way with fixed flow

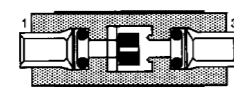

One-way with adjustable flow

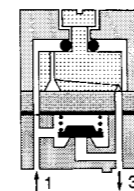

Dimensions

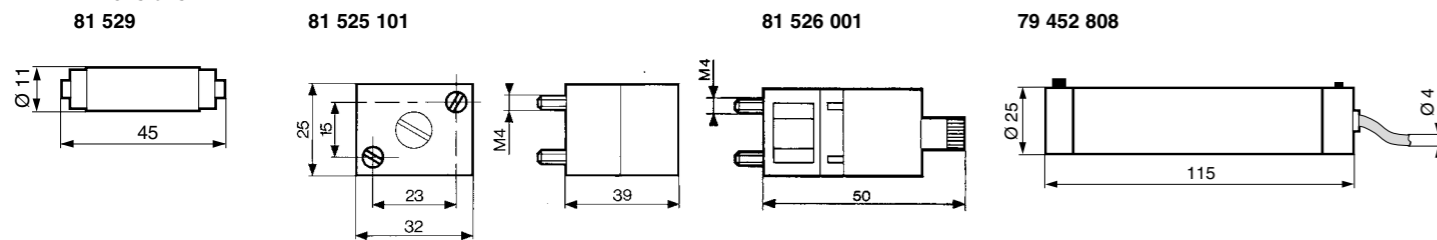

ATEX version products are available in the following catalogues: **Pneumatic products for explosive atmospheres** or on our website www.crouzet.com

Regulator accessories

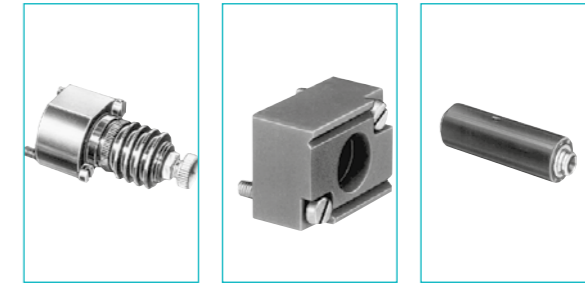

Also available in **ATEX** version for use in potentially explosive atmospheres in accordance with 94/9/EC Directive

Part numbers

Mini-détenteur	81 527 001	—	—
Plug element	—	81 520 601	—
In-line non-return	—	—	81 529 901

Symbol

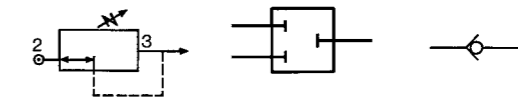

Characteristics

Operating pressure	bars	2 → 8	—	2 → 8
Flow at 6 bars	Nl/min	200	—	200
Adjustable output pressure	bar	0,1 → 8	—	—
Connection	Sub-base Push-in connection for semi-rigid tubing (NFE 49100)	•	•	—
Weight	g	150	70	70

Dimensions

81 529 901

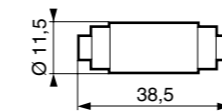

81 520 601

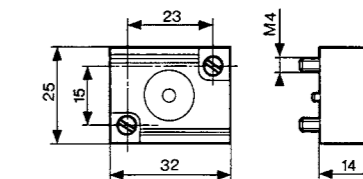

ATEX version products are available in the following catalogues: **Pneumatic products for explosive atmospheres** or on our website www.crouzet.com

Sub-bases for logic elements

Also available in **ATEX** version for use in potentially explosive atmospheres in accordance with 94/9/EC Directive

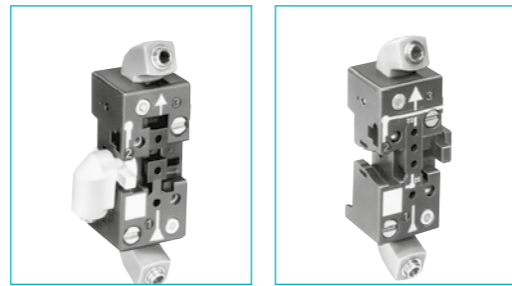

81 532 104	81 532 102
Two-hand start module	• 1
Manostats - vacuostats	• 1
Leak sensor and amplifier relays	• 1
Logic elements AND Timers	• 1
Regulator accessories	• 1
Memory element	—
Operating temperature °C	-5 → +50
Electro-pneumatic miniature solenoid	• 1

NB: The number indicates the number of components mounted on the sub-base ↑

Characteristics

Push-in connection for semi-rigid tubing Ø 4 mm (NFE 49100)	rotatable	rotatable
Fixation	DIN rail 35 mm	DIN rail 35 mm
Weight	g 56	g 52

Connections elements and relays

Front connecting

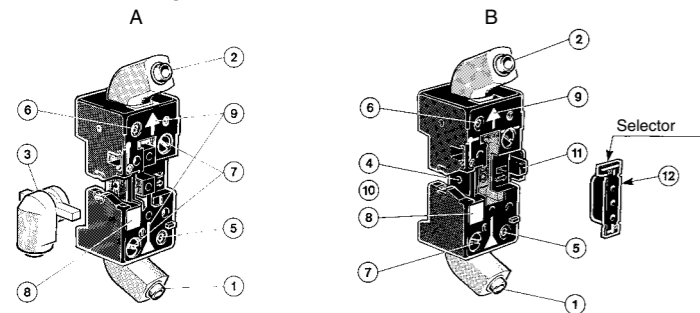

- A - Single sub-base or end base
- B - Associable sub-base
- 1 - Input port (green port 1)
- 2 - Output port (red port 3)
- 3 - Input/supply port (yellow port 2) Ø 4
- 4 - Input port integral to sub-base
- 5 - Input indicator (green)
- 6 - Output indicator (red)
- 7 - 1/4 turn screws
- 8 - Marking tag
- 9 - Arrow indicating flow direction
- 10 - Mounting tongue
- 11 - Mounting groove
- 12 - Selector

Dimensions

81 532 104 3 x 81532102

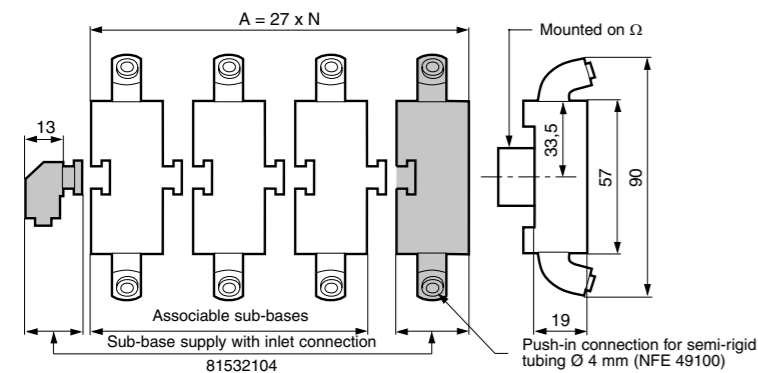

ATEX version products are available in the following catalogues: **Pneumatic products for explosive atmospheres** or on our website www.crouzet.com

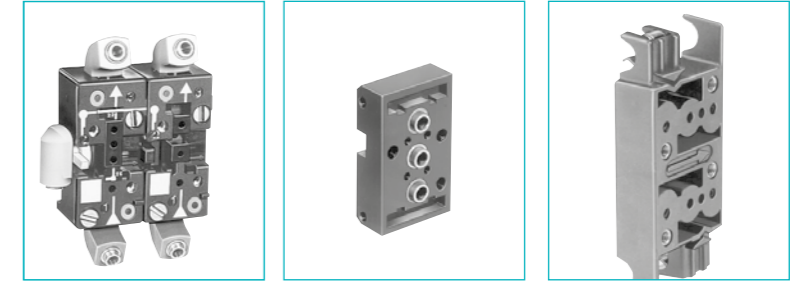

81 542 002	81 532 001	81 531 001
Two-hand start module	—	• 2
Manostats - vacuostats	• 1	• 2
Leak sensor and amplifier relays	• 1	• 2
Logic elements AND Timers	• 1	• 2
Regulator accessories	• 1	• 2
Memory element	• 1	• 1
Operating temperature °C	-5 → +50	-5 → +50
Electro-pneumatic miniature solenoid	—	• 2

Caractéristiques

Push-in connection for semi-rigid tubing Ø 4 mm (NFE 49100)	rotatable	rear	rear
Fixation	DIN rail 35 mm	2 M4 screws	Clips for rails Ø 8 mm
Weight	g 95	g 10	g 35

Memory element sub-base, front and rear connecting

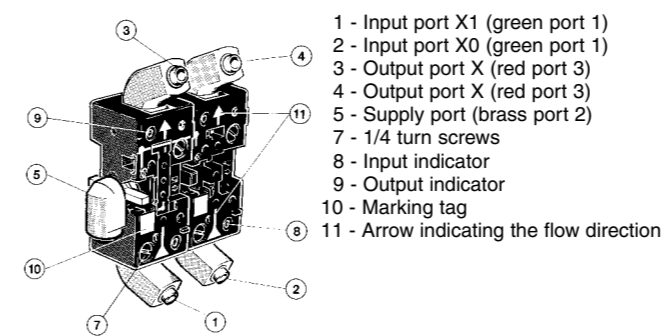

- 1 - Input port X1 (green port 1)
- 2 - Input port X0 (green port 1)
- 3 - Output port X (red port 3)
- 4 - Output port X (red port 3)
- 5 - Supply port (brass port 2)
- 7 - 1/4 turn screws
- 8 - Input indicator
- 9 - Output indicator
- 10 - Marking tag
- 11 - Arrow indicating the flow direction

Rear connection

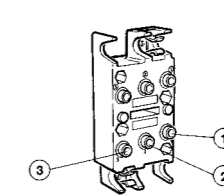

The modular system elements are fixed with two screws on the sub-base. A locating device on each logic element prevents incorrect assembly. The logic element is connected via the sub-base. This sub-base has 3 instant connections for connecting semi-rigid tubes with outer Ø 4.

- 1 - Input signal
- 2 - Signal port for passive logic elements, air supply for active logic elements.
- 3 - Output signal

81 542 002 (for memory 81523201/601)

81 531 001

81 532 001

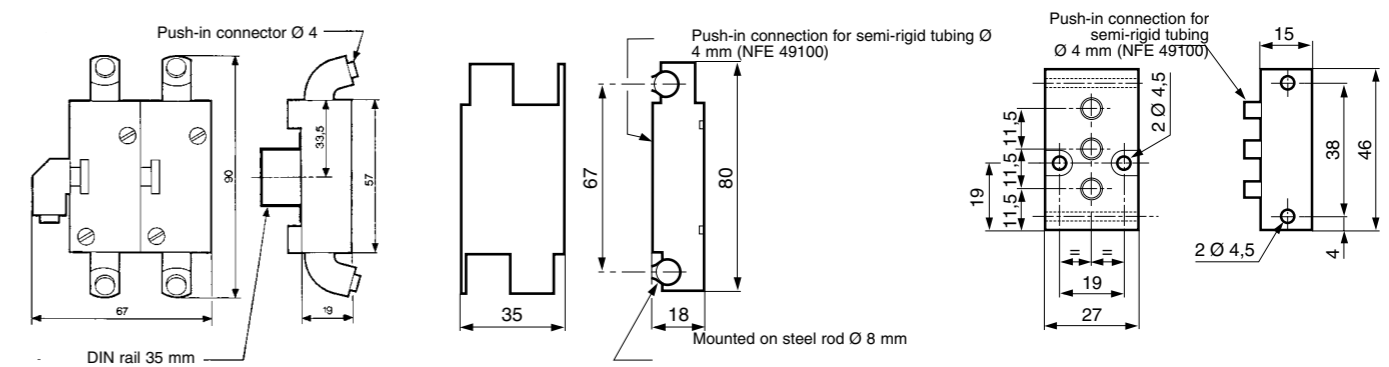

ATEX version products are available in the following catalogues: **Pneumatic products for explosive atmospheres** or on our website www.crouzet.com

Mounting accessories



Also available in **ATEX** version for use in potentially explosive atmospheres in accordance with 94/9/EC Directive

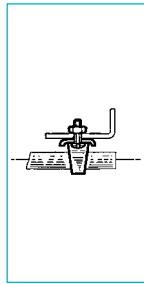
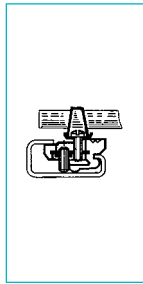
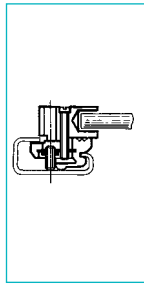

Mounting equipment

81 533 501
Hole domino

81 533 001
Clip domino

79 450 609
Bar clips
Ø 8

—

Supply manifold 13 outputs

—

—

—

81 536 801

Characteristics

Weight (g)	8 For mounting on the end of a zinc-coated mild steel rod Ø 8 mm on an asymmetrical DIN rail	4 For adjustable mounting on a zinc-coated mild steel rod Ø 8 mm on an asymmetrical DIN rail	80 Packet of 100 pieces	80
Operating temperature °C	-5 → +50	-5 → +50	-5 → +50	-5 → +50

Dimensions

81 536 804

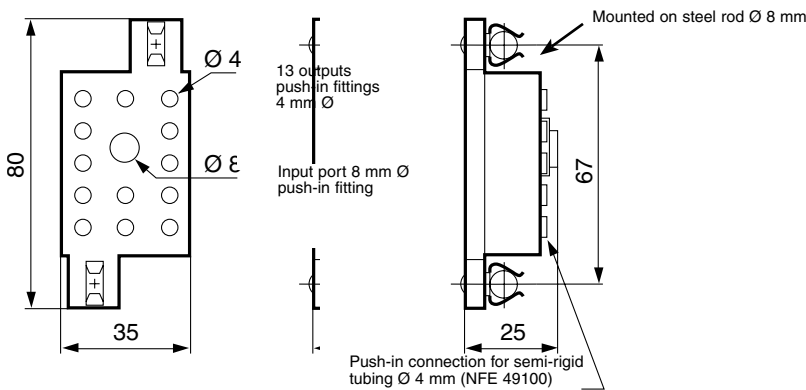

Other information

Use Weidmuller plastic labels for marking components part number FW 4734-6.

ATEX version products are available in the following catalogues: **Pneumatic products for explosive atmospheres** or on our website www.crouzet.com

Mouser Electronics

Authorized Distributor

Click to View Pricing, Inventory, Delivery & Lifecycle Information:

Crouzet:

[81501025](#) [81521501](#) [81522501](#) [81523601](#) [81529003](#) [81529005](#) [81529007](#) [81529025](#) [81532001](#) [81532104](#)
[81541001](#) [81550001](#) [81503540](#) [81542002](#) [81551101](#) [81550201](#) [81520601](#) [81529004](#) [81522504](#) [81523201](#)
[81526001](#) [81552101](#) [81551001](#) [81529010](#) [81503720](#) [81540001](#) [81536801](#) [81506720](#) [81506725](#) [81550601](#)
[81550401](#) [81552105](#) [79450609](#) [81533001](#) [81529002](#) [81529901](#) [81541005](#) [81506025](#) [81552002](#) [81552001](#)
[79452808](#) [81503710](#) [81551104](#) [81507720](#) [81521507](#) [81525101](#) [81531001](#) [81506940](#) [81526003](#) [81506710](#)
[81533501](#) [81540005](#) [81507540](#) [81550013](#) [81529006](#) [81503025](#) [81503725](#) [81552601](#) [81529008](#) [81527001](#)
[81552102](#)