

Introducing
**POSITIVE LOCK
CONNECTORS
FOR HVAC
MOTORS**

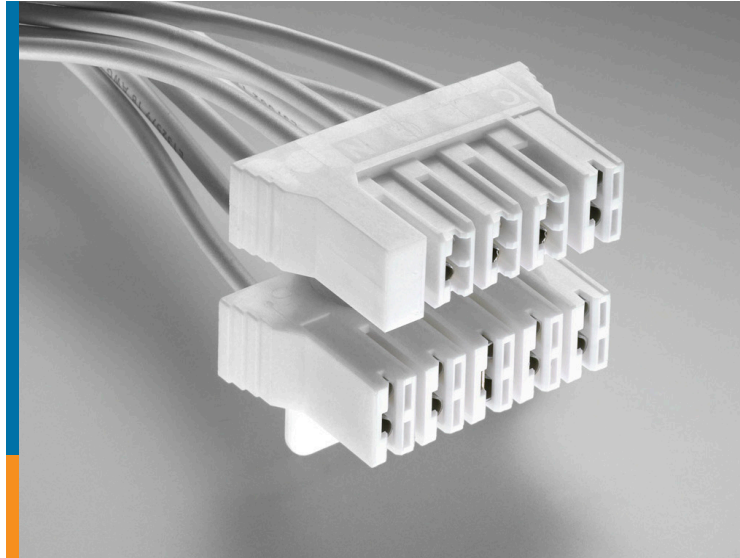

POSITIVE LOCK CONNECTORS FOR HVAC MOTORS

Description

- Four and five position connectors designed to mate to power and discrete speed tap control contacts on high efficiency residential HVAC blower motors
- Designed using TE Connectivity's Mark III Positive Lock Connection System
- Ergonomically friendly, one piece housing design

Applications

- High efficiency residential HVAC blower motors

Mechanical

- Application specification 114-2074

Materials

- Housings: UL 94 V-0 Nylon, white
- Terminals: Unplated or tin plated brass

Product Offering

- Housing part number: 521781-1, 4-position
- Terminal part number: For Circuit C (Low Voltage Signal Common)
250 Series Mark III Positive Lock Receptacles 63933-X, 63854-X, 1217092-X
For Circuits L, G, and N (Line Voltage)
187 Series Mark III Positive Lock Receptacles 1217113-X and 1217114-X
- Housing part number: 521780-1, 5-position
- Terminal part number: 250 Series Mark III Positive Lock Receptacles 63933-X, 63854-X, 1217092-X

Key Features

- Ergonomically friendly, one piece housing designs
- Low mating force
- Positive locking to mating tabs
- Audible click upon mating
- Housings keyed to ensure proper position and orientation at mating
- Housings made from UL 94 V-0 Flammability Rated Material

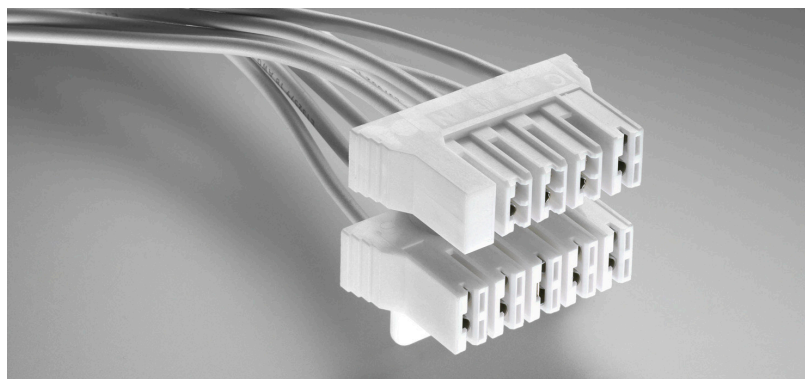

POSITIVE LOCK CONNECTORS FOR HVAC MOTORS

Standards and Specifications

- UL Recognized & CSA Certified
- RoHS Compliant
- Application Specification 114-2074

Product Dimensions and Part Numbers

- Mark III Receptacle Housing for HVAC Motor

Material	Color			Part Number
Nylon	Natural	X	X	521781-1
Nylon	Natural	X	X	521780-1

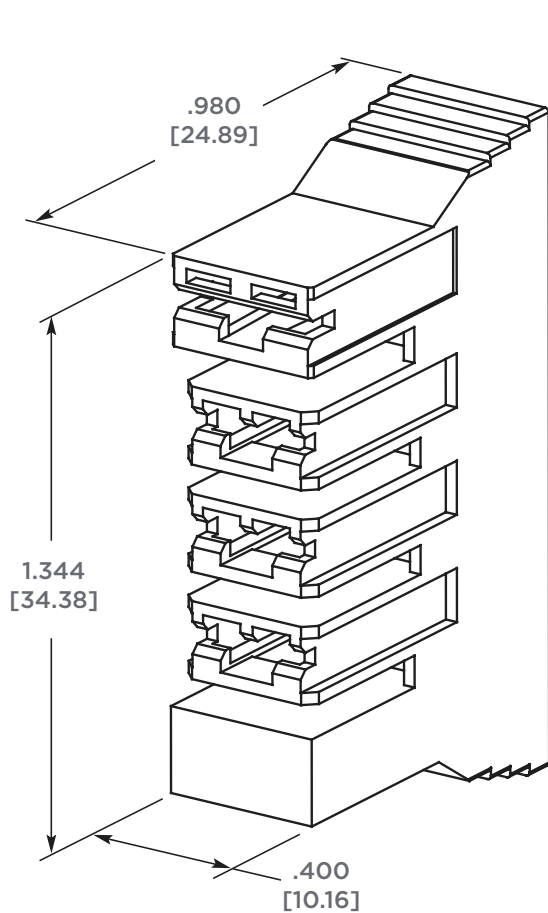

Part Number 521781-1
4-Position

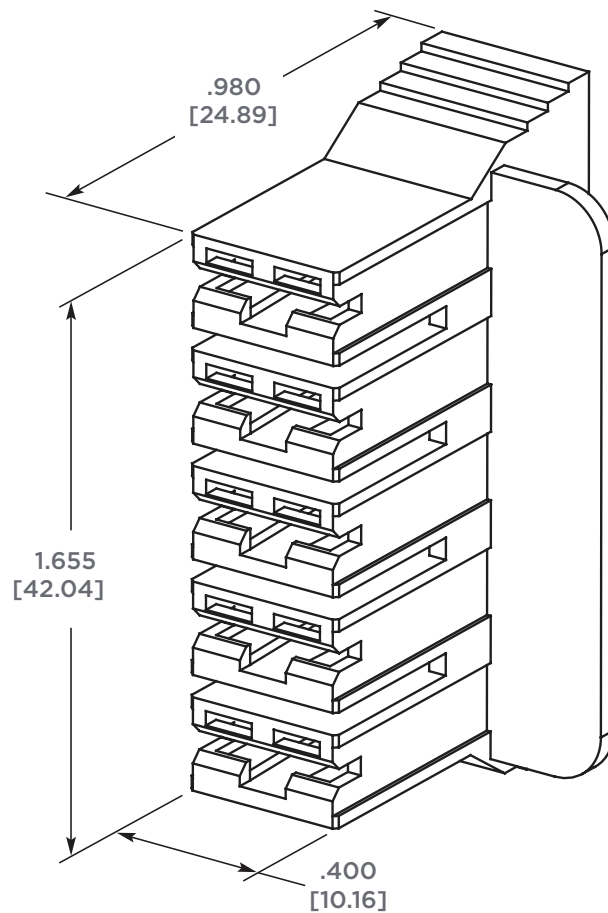

Part Number 521780-1
5-Position

TE Connectivity Technical Support Center

USA:	+1 (800) 522-6752
Canada:	+1 (905) 475-6222
Mexico:	+52 (0) 55-1106-0800
Latin/S. America	+54 (0) 11-4733-2200
Germany:	+49 (0) 6251-133-1999
UK:	+44 (0) 800-267666
France:	+33 (0) 1-3420-8686
Netherlands:	+31 (0) 73-6246-999
China:	+86 (0) 400-820-6015

te.com

© 2015 TE Connectivity Ltd. family of companies. All Rights Reserved.

4-1773449-8 APP CS 11/2015

TE Connectivity, the TE connectivity (logo), and Positive Lock are trademarks of the TE Connectivity Ltd. family of companies.

While TE has made every reasonable effort to ensure the accuracy of the information in this document, TE does not guarantee that it is error-free, nor does TE make any other representation, warranty or guarantee that the information is accurate, correct, reliable or current. TE reserves the right to make any adjustments to the information contained herein at any time without notice. TE EXPRESSLY DISCLAIMS ALL IMPLIED WARRANTIES REGARDING THE INFORMATION CONTAINED HEREIN, INCLUDING, BUT NOT LIMITED TO, ANY IMPLIED WARRANTIES OF MERCHANTABILITY OR FITNESS FOR A PARTICULAR PURPOSE. In no event will TE be liable for any direct, indirect, incidental, special or consequential damages arising from or related to recipient's use of the information. It is the sole responsibility of the recipient of this information to verify the results of this information using their engineering and product environment. Recipient assumes and all risks associated with the use of the information. The dimensions in this document are for reference purposes only and are subject to change without notice. All specifications are subject to change without notice. Consult TE for the latest dimensions and design specifications.

Mouser Electronics

Authorized Distributor

Click to View Pricing, Inventory, Delivery & Lifecycle Information:

[TE Connectivity:](#)

[521781-1](#)