

THIS DRAWING IS UNPUBLISHED. RELEASED FOR PUBLICATION 20
 © COPYRIGHT 20 BY - ALL RIGHTS RESERVED.

LOC		DIST		REVISIONS			
P	LTR	DESCRIPTION		DATE	DWN	APVD	
	B1	REVISED PER ECR-15-008087		02JUN2015	NK	JR	

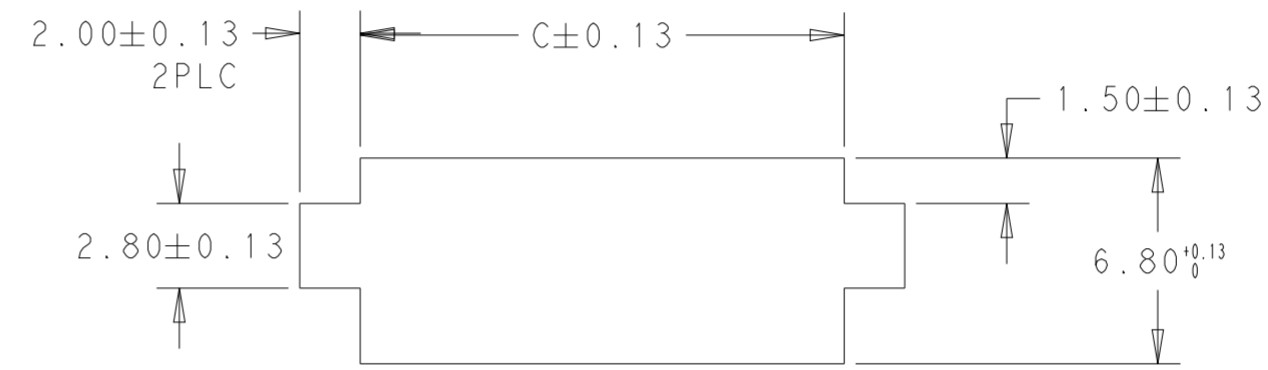

1. MATERIAL: NYLON UL94 - V0
COLOR: WHITE
2. ACCEPTS TE PIN CONTACTS
P/N'S 2238007-()
3. HOUSING ACCEPTS OPTIONAL TPA
P/N'S 1969443-()
4. MATES WITH TE PLUG HOUSINGS
P/N'S 1969442-()

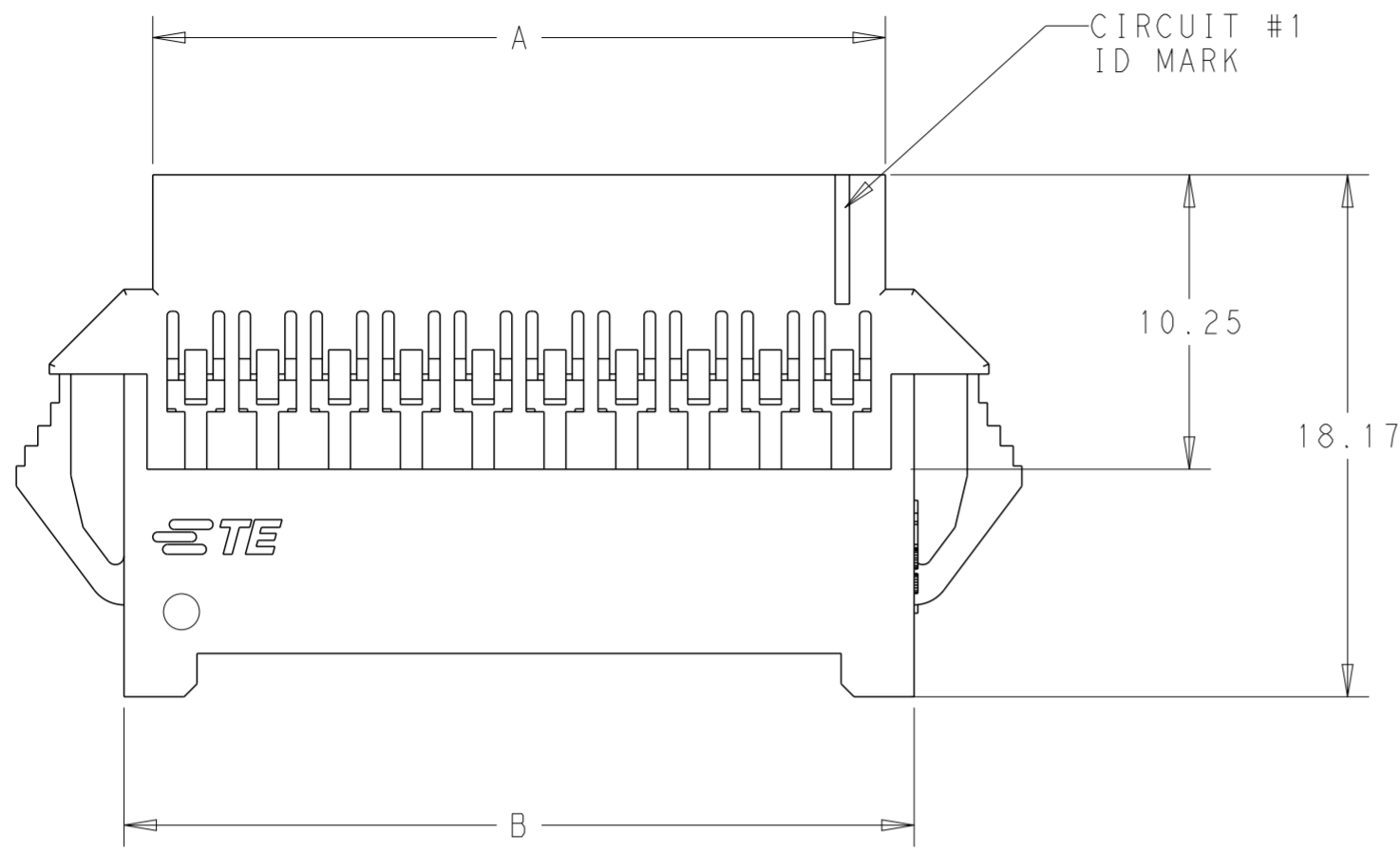
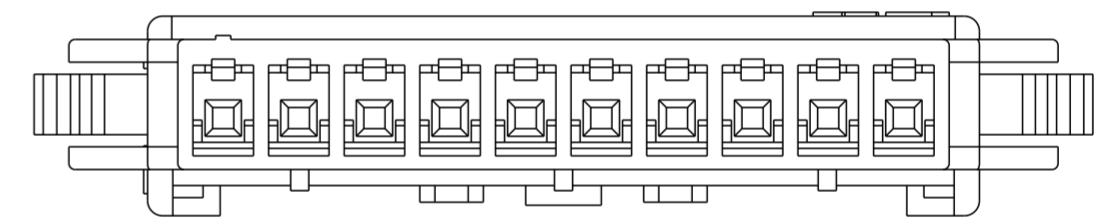
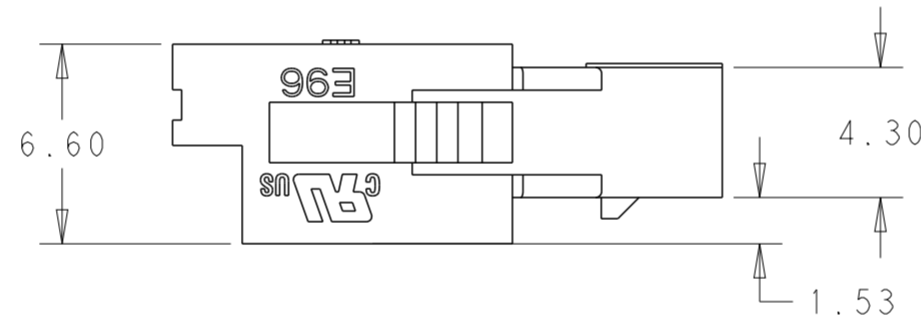
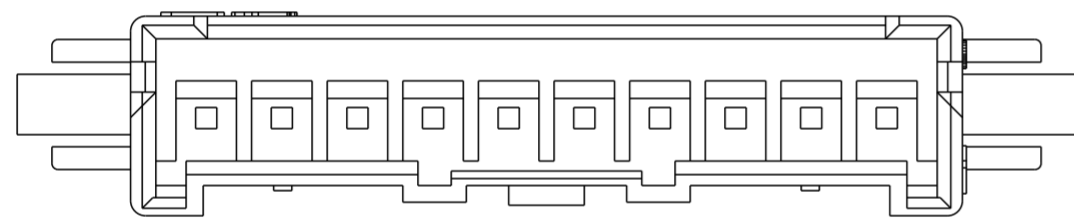

6 TO 15 POSITION
 1744501-6 TO 1-1744501-5

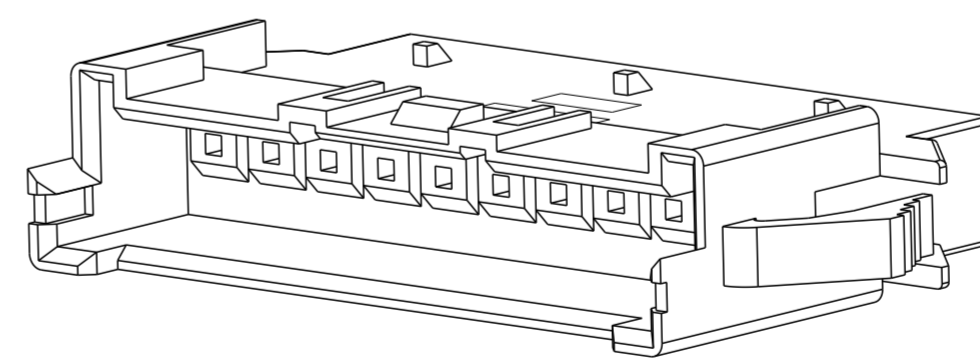
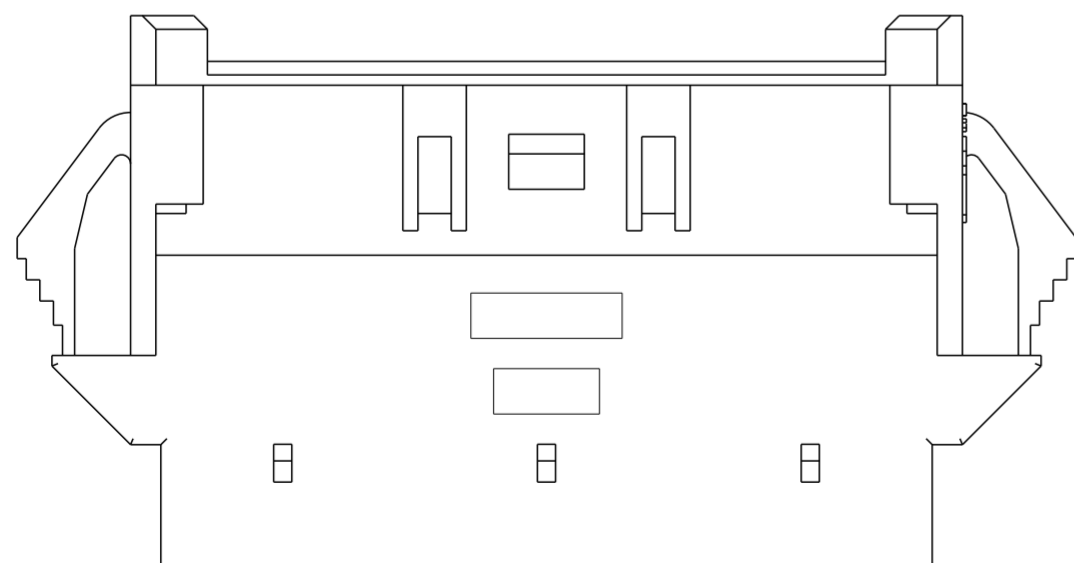

POS	DIM.C	DIM.B	DIM.A	PART NO.
15	41.00	40.00	38.00	1-1969590-5
14	38.50	37.50	35.50	1-1969590-4
13	34.00	35.00	33.00	1-1969590-3
12	33.50	32.50	30.50	1-1969590-2
11	31.00	30.00	28.00	1-1969590-1
10	28.50	27.50	25.50	1-1969590-0
9	26.00	25.00	23.00	1969590-9
8	23.50	22.50	20.50	1969590-8
7	21.00	20.00	18.00	1969590-7
6	18.50	17.50	15.50	1969590-6
5	16.00	15.00	13.00	1969590-5
4	13.50	12.50	10.50	1969590-4
3	11.00	10.00	8.00	1969590-3
2	8.50	7.50	5.50	1969590-2

THIS DRAWING IS A CONTROLLED DOCUMENT.

DIMENSIONS: mm	TOLERANCES UNLESS OTHERWISE SPECIFIED: 0 PLC ± 1 PLC ± 2 PLC ±0.20 3 PLC ± 4 PLC ± ANGLES ± FINISH	DWN A NOEL 28SEP2012 CHK K RANDOLPH 01OCT2012 APVD K RANDOLPH 01OCT2012 PRODUCT SPEC 108-2418 APPLICATION SPEC 114-13315 WEIGHT -	TE Connectivity NAME ECONOMY POWER 2.5, HOUSING WIRE TO WIRE, WITH PANEL MOUNTS SIZE A2 CAGE CODE C-1969590 DRAWING NO 114-13315 RESTRICTED TO -	
MATERIAL SEE TABLE	SEE TABLE	Customer Drawing	SCALE 4:1	SHEET 1 OF 2

THIS DRAWING IS UNPUBLISHED. RELEASED FOR PUBLICATION 20
 © COPYRIGHT 20 BY - ALL RIGHTS RESERVED.

LOC		DIST		REVISIONS			
P	LTR	DESCRIPTION	DATE	DWN	APVD		
-	-	SEE SHEET 1	-	-	-		

2 POSITION
1969590-2

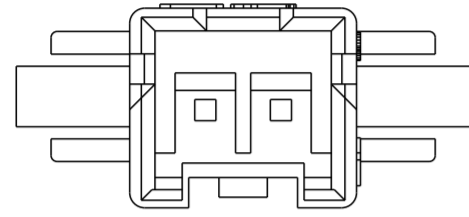

3 POSITION
1969590-3

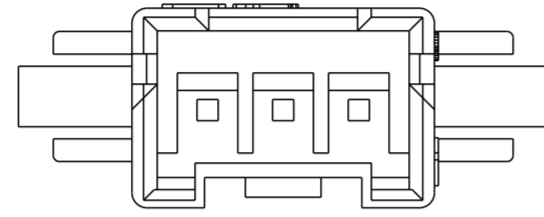

4 POSITION
1969590-4

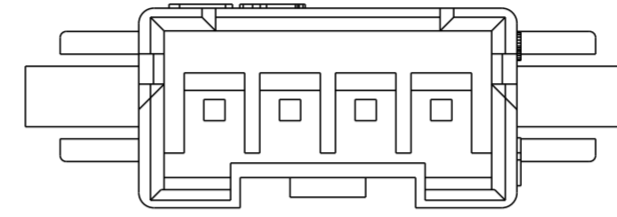

5 POSITION
1969590-5

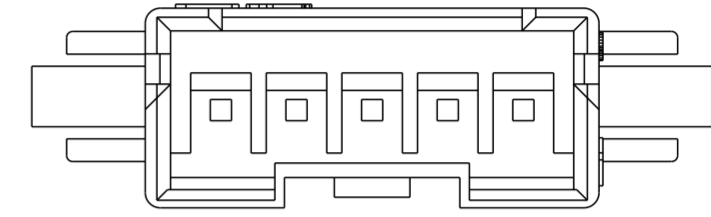

6-15 POSITION
1969590-6 TO 1-1969590-5

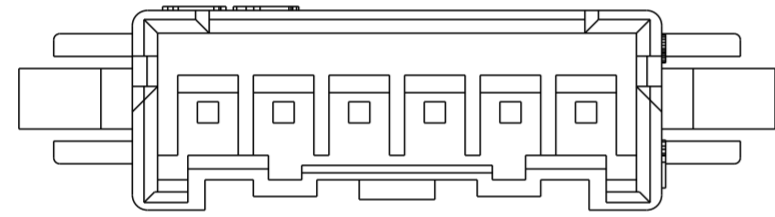

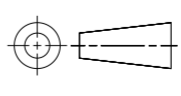
THIS DRAWING IS A CONTROLLED DOCUMENT.		DWN A. NOEL 28SEP2012	 TE Connectivity	
DIMENSIONS: mm		CHK K. RANDOLPH 01OCT2012		
TOLERANCES UNLESS OTHERWISE SPECIFIED:		APVD K. RANDOLPH 01OCT2012	NAME ECONOMY POWER 2.5, HOUSING WIRE TO WIRE, WITH PANEL MOUNTS	
		PRODUCT SPEC 108-2418	RESTRICTED TO -	
MATERIAL SEE TABLE		APPLICATION SPEC 114-13315	SIZE A200779	DRAWING NO C-1969590
FINISH SEE TABLE		WEIGHT -	SCALE 4:1	SHEET 2 OF 2
		Customer Drawing	REV B1	

Mouser Electronics

Authorized Distributor

Click to View Pricing, Inventory, Delivery & Lifecycle Information:

[TE Connectivity:](#)

[1-1969590-4](#)