

400 W TVS in STmite Flat

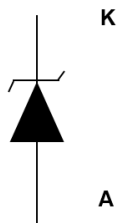
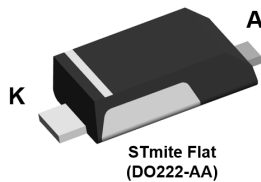

Unidirectional

Features

- Peak pulse power: 400 W (10/1000 μ s) and 2.5 kW (8/20 μ s)
- Flat and thin package: 0.85 mm
- Stand-off voltage range from 5 V to 33 V
- Unidirectional type
- Low leakage current: 0.2 μ A at 25 °C and 1 μ A at 85 °C
- Operating T_j max: 175 °C
- High power capability at T_j max.: up to 160 W (10/1000 μ s)
- Lead finishing: matte tin plating

Complies with the following standards

- UL94, V0
- J-STD-020 MSL level 1
- J-STD-002, JESD 22-B102 E3 and MIL-STD-750, method 2026
- JESD-201 class 2 whisker test
- IPC7531 footprint and JEDEC registered package outline
- IEC 61000-4-2, C = 150 pF - R = 330 Ω exceeds level 4:
 - 30 kV (contact discharge)
 - 30 kV (air discharge)
- IEC 61000-4-4
 - 4 kV

Description

The SMM4F TVS series are designed to protect sensitive circuits against transient surges.

The planar technology makes it compatible with high-end circuits where low leakage current and high junction temperature are required to provide long term reliability and stability.

Product status link	
SMM4F	SMM4F5.0A , SMM4F6.0A , SMM4F6.5A , SMM4F8.5A , SMM4F10A , SMM4F12A , SMM4F13A , SMM4F15A , SMM4F18A , SMM4F20A , SMM4F24A , SMM4F26A , SMM4F28A , SMM4F33A

1 Characteristics

Table 1. Absolute maximum ratings ($T_{amb} = 25\text{ }^{\circ}\text{C}$)

Symbol	Parameter	Value	Unit	
V_{PP}	Peak pulse voltage	IEC 61000-4-2 (C = 150 pF, R = 330 Ω)	kV	
		Contact discharge		30
		Air discharge		30
P_{PP}	Peak pulse power dissipation	10/1000 μs , T_j initial = T_{amb}	400	W
T_{stg}	Storage temperature range		-65 to +175	$^{\circ}\text{C}$
T_j	Operating junction temperature range		-55 to +175	$^{\circ}\text{C}$
T_L	Maximum lead temperature for soldering during 10 s		260	$^{\circ}\text{C}$

Figure 1. Electrical characteristics - parameter definitions

- V_{RM} Maximum stand-off voltage
- I_{RM} Maximum leakage current @ V_{RM}
- V_R Stand-off voltage
- I_R Leakage current @ V_R
- V_{BR} Breakdown voltage @ I_{BR}
- I_{BR} Breakdown current
- V_{CL} Clamping voltage @ I_{PP}
- I_{PP} Peak pulse current
- R_D Dynamic resistance
- V_F Forward voltage drop @ I_F
- I_F Forward current
- αT Voltage temperature coefficient

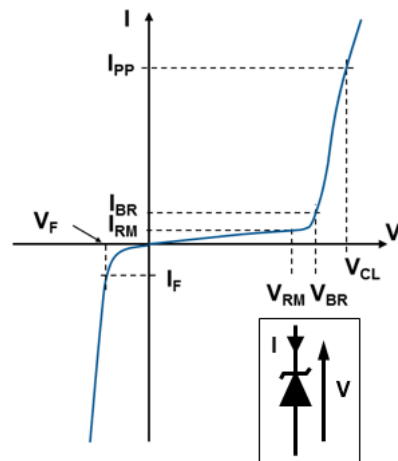

Figure 2. Pulse definition for electrical characteristics

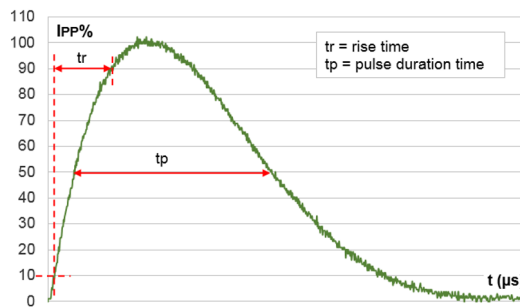

Table 2. Electrical characteristics - parameter values ($T_{amb} = 25\text{ }^{\circ}\text{C}$, unless otherwise specified)

Type	I_{RM} max at V_{RM}			V_{BR} at $I_{BR}^{(1)}$				10 / 1000 μs			8 / 20 μs			αT
								$V_{CL}^{(2)(3)}$	$I_{PP}^{(4)}$	R_D	$V_{CL}^{(2)(3)}$	$I_{PP}^{(4)}$	R_D	
	25 $^{\circ}\text{C}$	85 $^{\circ}\text{C}$		Min.	Typ.	Max.		Max.		Max.	Max.		Max.	
	μA	V		V			mA	V	A	Ω	V	A	Ω	$10^{-4}/^{\circ}\text{C}$
SMM4F5.0A	10	50	5.0	6.46	6.80	7.14	10	9.2	43.5	0.047	13.4	179	0.035	5.7
SMM4F6.0A	10	50	6.0	6.65	7.00	7.35	10	10.3	38.8	0.076	13.7	175	0.036	5.9
SMM4F6.5A	10	50	6.5	7.13	7.50	7.88	10	11.2	35.7	0.093	14.5	166	0.040	6.1
SMM4F8.5A	10	50	8.5	9.5	10.0	10.5	1	14.4	27.7	0.141	19.5	140	0.064	7.3
SMM4F10A	0.2	1	10	11.4	12.0	12.6	1	17.0	23.5	0.188	21.7	127	0.072	7.8
SMM4F12A	0.2	1	12	13.3	14.0	14.7	1	19.9	20.1	0.259	25.3	112	0.095	8.3
SMM4F13A	0.2	1	13	14.3	15.0	15.8	1	21.5	18.6	0.306	27.2	106	0.108	8.4
SMM4F15A	0.2	1	15	17.1	18.0	18.9	1	24.4	16.4	0.335	32.5	90	0.151	8.8
SMM4F18A	0.2	1	18	20.9	22.0	23.1	1	29.2	14.0	0.436	39.3	76	0.213	9.2
SMM4F20A	0.2	1	20	22.8	24.0	25.2	1	32.4	12.0	0.600	42.8	70	0.250	9.4
SMM4F24A	0.2	1	24	26.6	28.0	29.4	1	38.9	9.5	1.00	50	61	0.338	9.6
SMM4F26A	0.2	1	26	28.5	30.0	31.5	1	42.1	9.0	1.18	53.5	58	0.380	9.7
SMM4F28A	0.2	1	28	31.4	33.0	34.7	1	45.4	8.0	1.34	59	53	0.458	9.8
SMM4F33A	0.2	1	33	37.1	39.0	41.0	1	53.3	7.0	1.76	69.7	45	0.638	10

1. To calculate V_{BR} versus T_j : V_{BR} at $T_j = V_{BR}$ at $25\text{ }^{\circ}\text{C} \times (1 + \alpha T \times (T_j - 25))$
2. To calculate V_{CL} versus T_j : V_{CL} at $T_j = V_{CL}$ at $25\text{ }^{\circ}\text{C} \times (1 + \alpha T \times (T_j - 25))$
3. To calculate V_{CLmax} versus $I_{PPappli}$: $V_{CLmax} = V_{BRmax} + R_D \times I_{PPappli}$
4. Surge capability given for both directions

1.1 Characteristics (curves)

Figure 3. Maximum peak power dissipation versus initial junction temperature

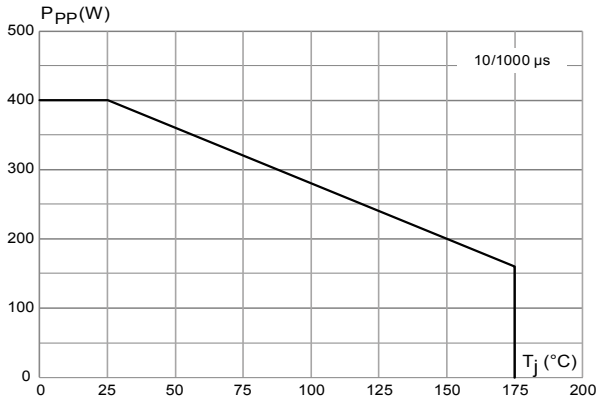

Figure 4. Maximum peak pulse power versus exponential pulse duration

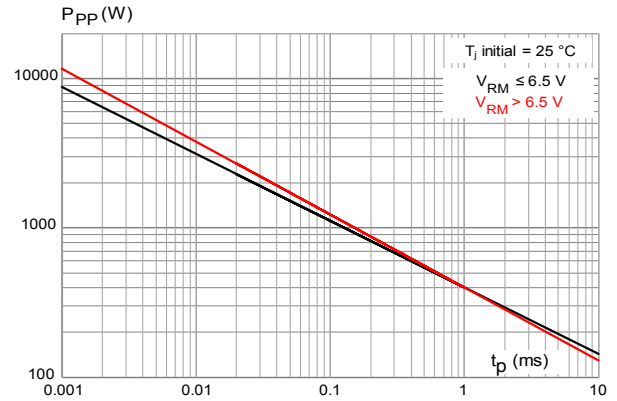

Figure 5. Maximum clamping voltage versus peak pulse current

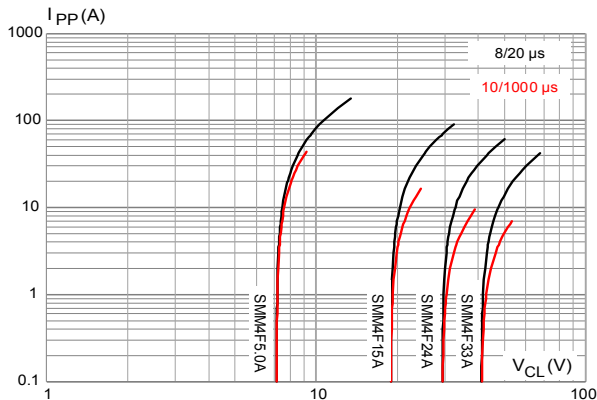

Figure 6. Dynamic resistance versus pulse duration

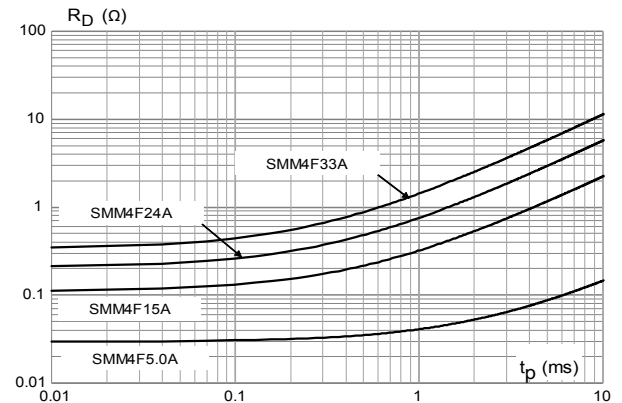

Figure 7. Junction capacitance versus reverse applied voltage

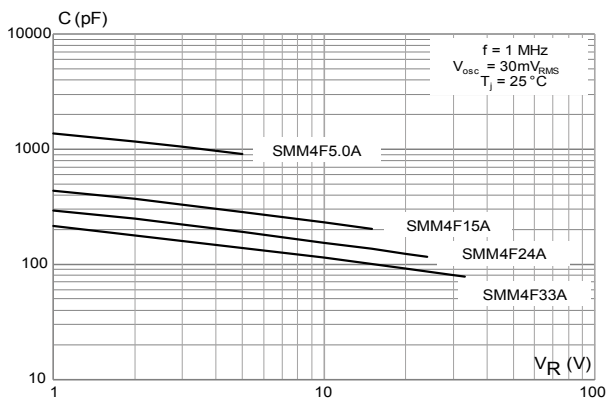

Figure 8. Leakage current versus junction temperature

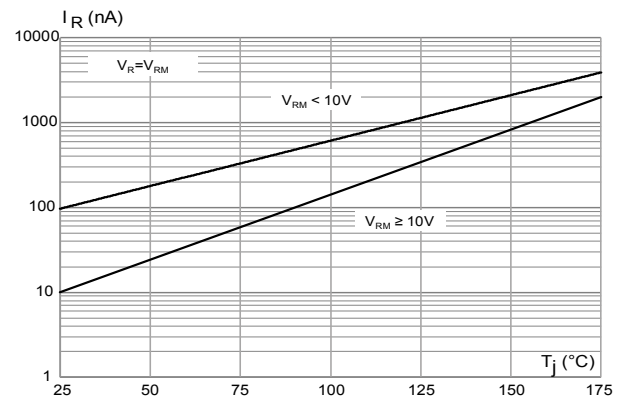

Figure 9. Peak forward voltage drop versus peak forward current

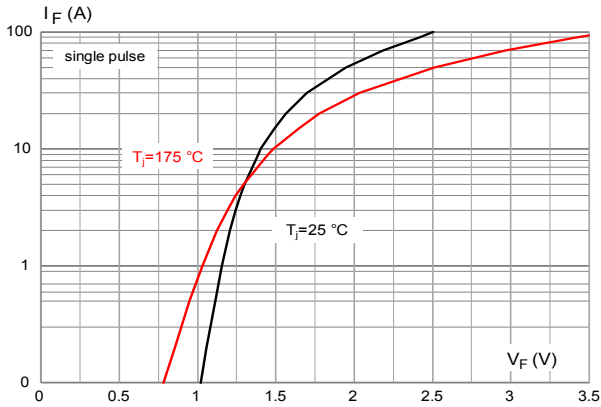

Figure 10. Thermal impedance junction to ambient versus pulse duration

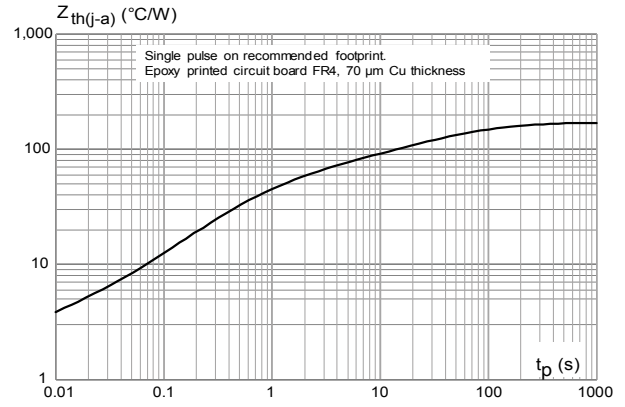
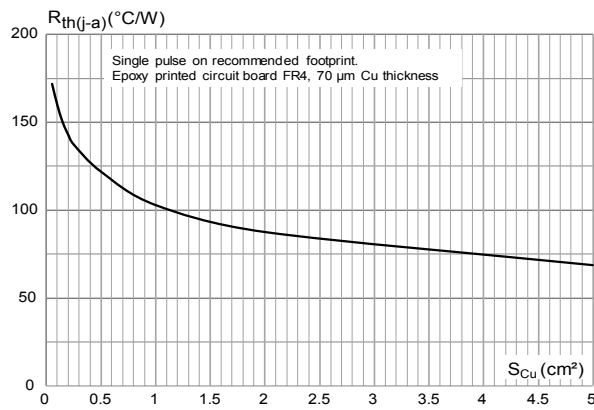

Figure 11. Thermal resistance junction to ambient versus copper surface under each lead



2 Package information

In order to meet environmental requirements, ST offers these devices in different grades of **ECOPACK** packages, depending on their level of environmental compliance. ECOPACK specifications, grade definitions and product status are available at: www.st.com. ECOPACK is an ST trademark.

2.1 STmite Flat package information

Figure 12. STmite Flat package outline

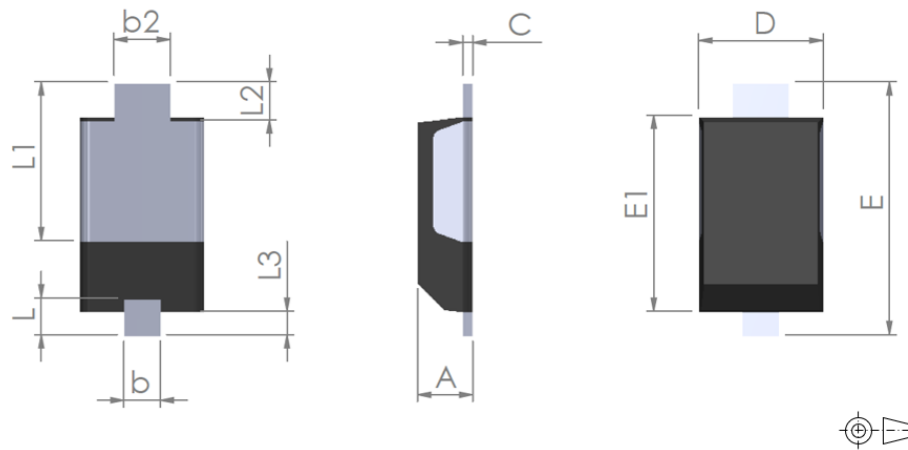

Table 3. STmite Flat mechanical data

Ref.	Dimensions					
	Millimeters			Inches		
	Min.	Typ.	Max.	Min.	Typ.	Max.
A	0.80	0.85	0.95	0.031	0.033	0.038
b	0.40	0.55	0.65	0.015	0.022	0.026
b2	0.70	0.85	1.00	0.027	0.033	0.040
c	0.10	0.15	0.25	0.003	0.006	0.010
D	1.75	1.90	2.05	0.068	0.075	0.081
E	3.60	3.80	3.90	0.141	0.150	0.154
E1	2.80	2.95	3.10	0.110	0.116	0.123
L	0.50	0.55	0.80	0.019	0.022	0.032
L1	2.10	2.40	2.60	0.082	0.094	0.103
L2	0.45	0.60	0.75	0.017	0.024	0.030
L3	0.20	0.35	0.50	0.007	0.014	0.020

Figure 13. Footprint recommendations, dimensions in mm (inches)

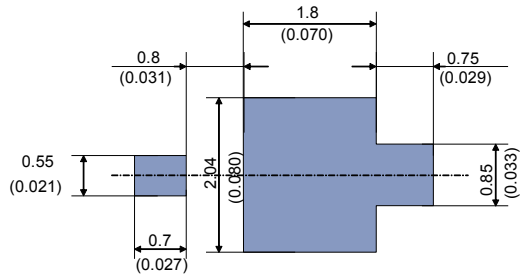

Figure 14. Marking layout (refer to ordering information table for marking)

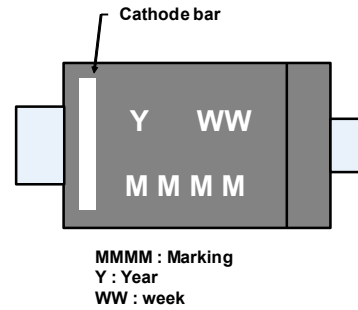
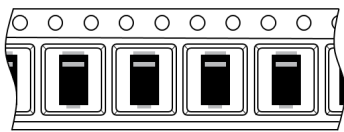

Figure 15. Package orientation in reel



Taped according to EIA-481
Note: Pocket dimensions are not on scale
Pocket shape may vary depending on package
On bidirectional devices, marking and logo may be not always in the same direction

Figure 16. Tape and reel orientation

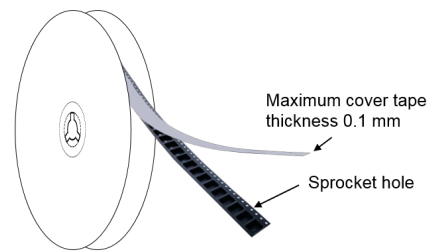

Figure 17. Reel dimensions (mm)

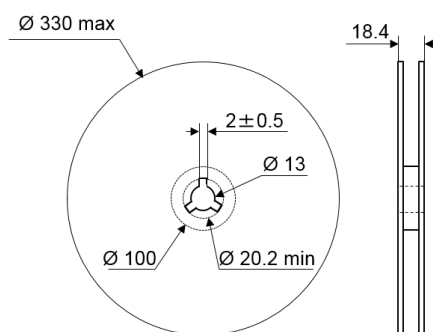

Figure 18. Inner box dimensions (mm)

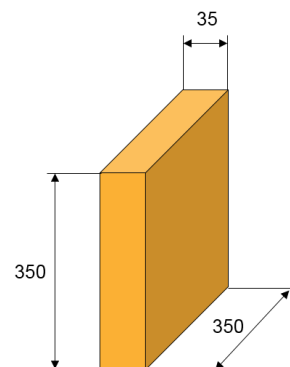
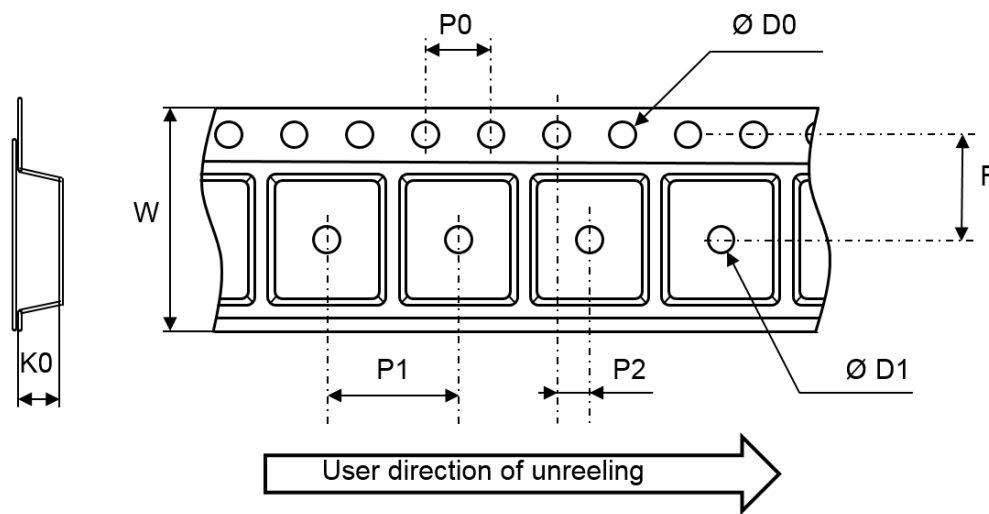

Figure 19. Tape and reel outline



Note: Pocket dimensions are not on scale
Pocket shape may vary depending on package

Table 4. Tape and reel mechanical data

Ref.	Dimensions		
	Millimeters		
	Min.	Typ.	Max.
P0	3.9	4	4.1
P1	3.9	4	4.1
P2	1.9	2	2.1
ØD0	1.5	1.55	1.6
ØD1	1.5		
F	5.4	5.5	5.6
K0	1.0	1.1	1.2
W	11.7	12	12.3

Figure 20. ST ECOPACK recommended soldering reflow profile for PCB mounting

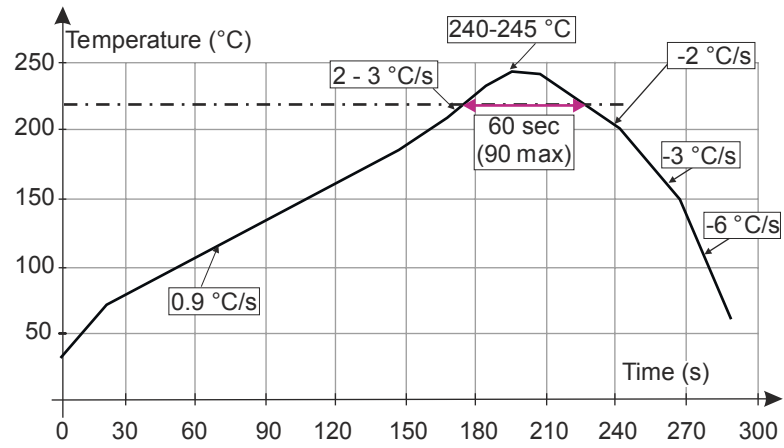

3 Ordering information

Figure 21. Ordering information scheme

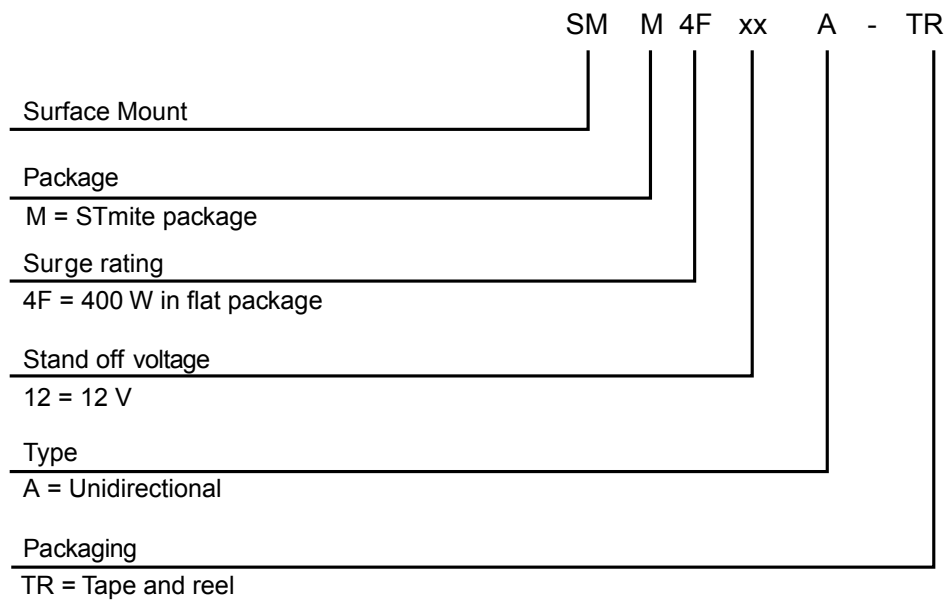

Table 5. Ordering information

Order code	Marking	Package	Weight	Base qty.	Delivery mode
SMM4FxxA-TR	See Table 6. Marking.	STmite Flat	16 mg	12000	Tape and reel

Table 6. Marking

Order code	Marking
SMM4F5.0A-TR	4UA
SMM4F6.0A-TR	4UB
SMM4F6.5A-TR	4UC
SMM4F8.5A-TR	4UD
SMM4F10A-TR	4UE
SMM4F12A-TR	4UF
SMM4F13A-TR	4UG
SMM4F15A-TR	4UH
SMM4F18A-TR	4UJ
SMM4F20A-TR	4UK
SMM4F24A-TR	4UM
SMM4F26A-TR	4UN
SMM4F28A-TR	4UO
SMM4F33A-TR	4UQ

Revision history

Table 7. Document revision history

Date	Version	Changes
29-Nov-2007	1	First issue.
19-Dec-2007	2	Updated I_{PP} and R_D parameters in columns 10 and 11 of Table 4.
19-Aug-2014	3	Updated package name.
19-Jan-2017	4	Updated cover page and Table 4.
03-Mar-2020	5	Updated document title, Section Description, Section 1 Characteristics and Section 1.1 Characteristics (curves).
15-Apr-2020	6	Updated Figure 5 and Figure 11.

IMPORTANT NOTICE – PLEASE READ CAREFULLY

STMicroelectronics NV and its subsidiaries (“ST”) reserve the right to make changes, corrections, enhancements, modifications, and improvements to ST products and/or to this document at any time without notice. Purchasers should obtain the latest relevant information on ST products before placing orders. ST products are sold pursuant to ST’s terms and conditions of sale in place at the time of order acknowledgement.

Purchasers are solely responsible for the choice, selection, and use of ST products and ST assumes no liability for application assistance or the design of Purchasers’ products.

No license, express or implied, to any intellectual property right is granted by ST herein.

Resale of ST products with provisions different from the information set forth herein shall void any warranty granted by ST for such product.

ST and the ST logo are trademarks of ST. For additional information about ST trademarks, please refer to www.st.com/trademarks. All other product or service names are the property of their respective owners.

Information in this document supersedes and replaces information previously supplied in any prior versions of this document.

© 2020 STMicroelectronics – All rights reserved