

THIS DRAWING IS UNPUBLISHED. RELEASED FOR PUBLICATION
 © COPYRIGHT copyright.d8Te- ALL RIGHTS RESERVED.

REVISIONS				
P	LTR	DESCRIPTION	DATE	APVD
A6		REVISED PER ECR-16-013589	08OCT2016	NK DC

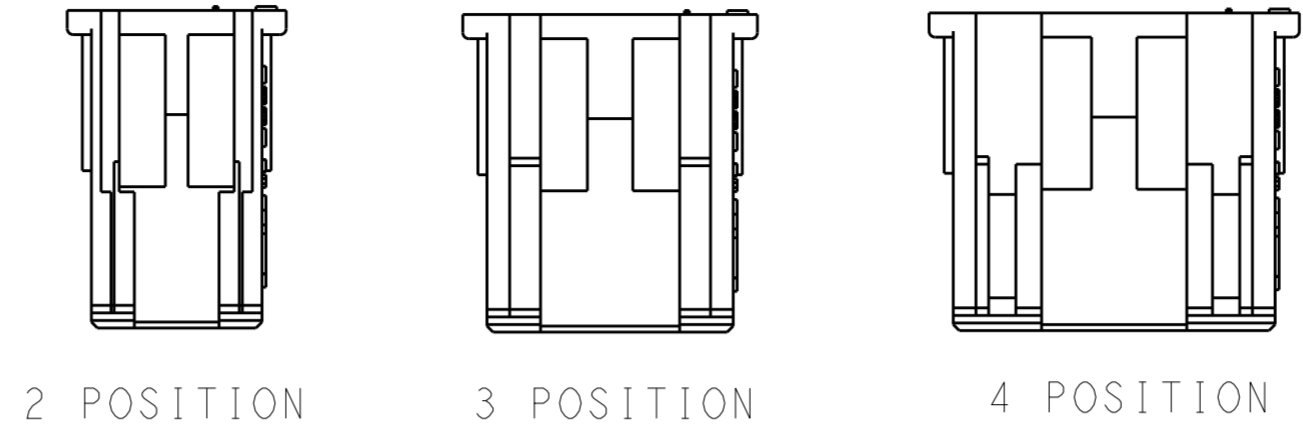

- 1 MATERIAL: NYLON UL94V-0
- 2 ACCEPTS TE RECEPTACLE P/N'S 2110989-()
- 3 THESE HOUSINGS CAN ACCEPT OPTIONAL TPA (RETAINER) P/N 1969443-().
- 4 MATES WITH TE HEADER ASSEMBLIES 2132230-() & 2132415-().
- △ PRELIMINARY - NOT FOR PRODUCTION

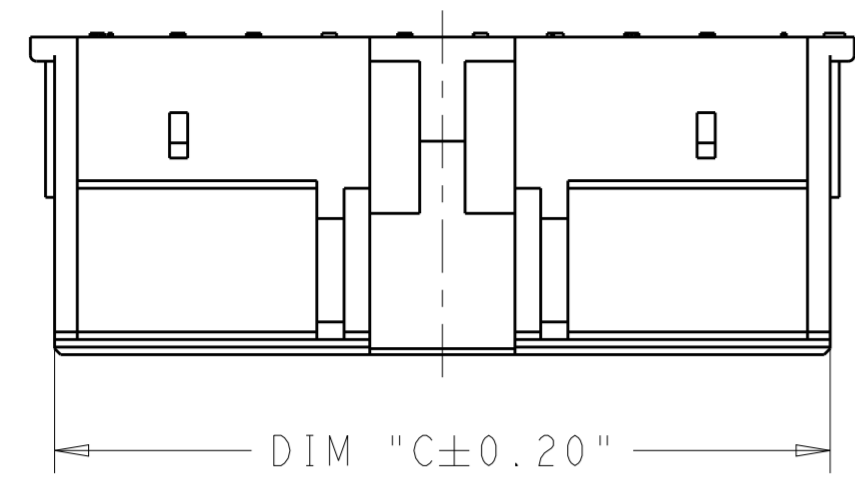
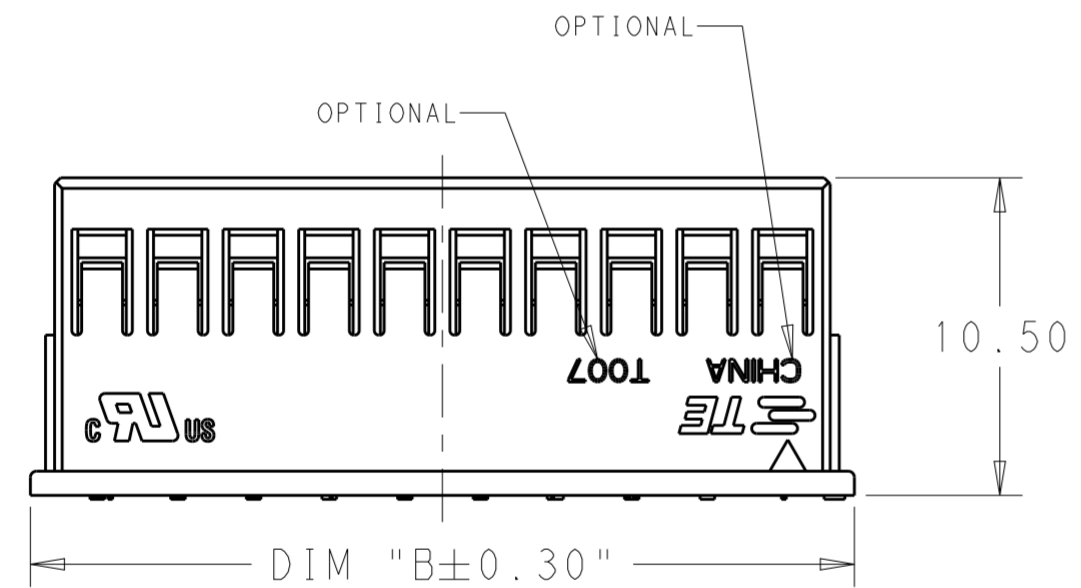
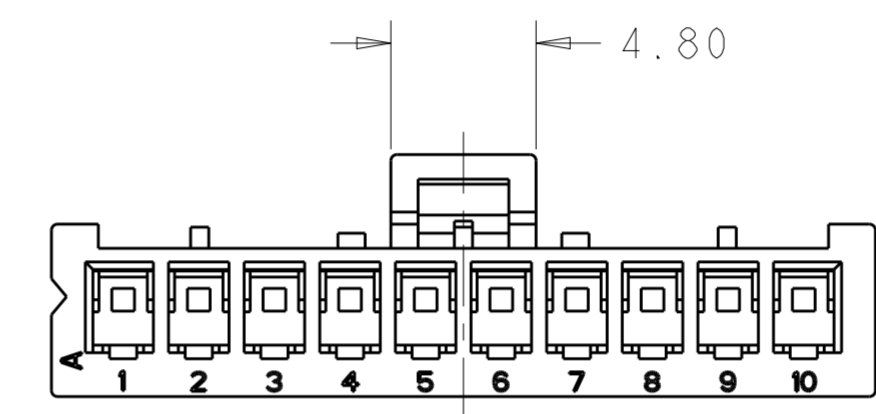
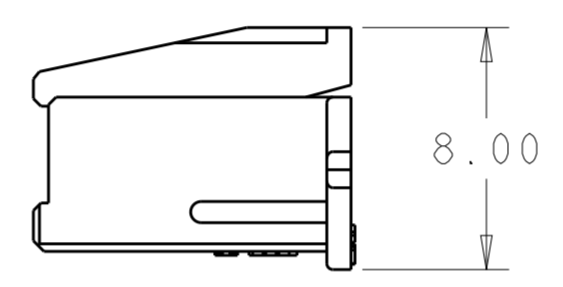
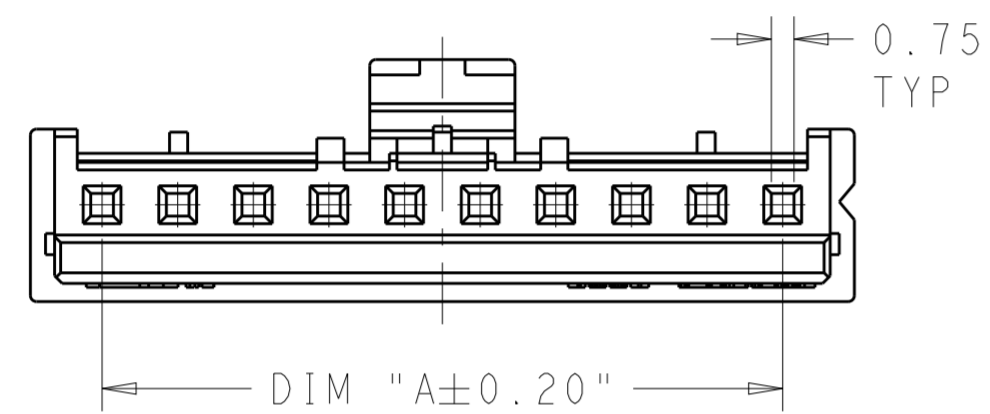

COLOR	DIM C	DIM B	DIM A	NO. OF POSITIONS	PART NUMBER
BLACK	5.64	7.3	2.5	2	△ 2304506-2
BLUE	5.64	7.3	2.5	2	△ 2304505-2
RED	5.64	7.3	2.5	2	△ 2304504-2
YELLOW	5.64	7.3	2.5	2	△ 2304503-2
RED	35.64	37.3	32.5	14	△ 3-1969442-4
NATURAL	50.64	52.3	47.5	20	2-1969442-0
	48.14	49.8	45.0	19	1-1969442-9
	45.64	47.3	42.5	18	1-1969442-8
	43.14	44.8	40.0	17	1-1969442-7
	40.64	42.3	37.5	16	1-1969442-6
	38.14	39.8	35.0	15	1-1969442-5
	35.64	37.3	32.5	14	1-1969442-4
	33.14	34.8	30.0	13	1-1969442-3
	30.64	32.3	27.5	12	1-1969442-2
	28.14	29.8	25.0	11	1-1969442-1
	25.64	27.3	22.5	10	1-1969442-0
	23.14	24.8	20.0	9	1969442-9
	20.64	22.3	17.5	8	1969442-8
	18.14	19.8	15.0	7	1969442-7
	15.64	17.3	12.5	6	1969442-6
13.14	14.8	10.0	5	1969442-5	
10.64	12.3	7.5	4	1969442-4	
8.14	9.8	5.0	3	1969442-3	
5.64	7.3	2.5	2	1969442-2	

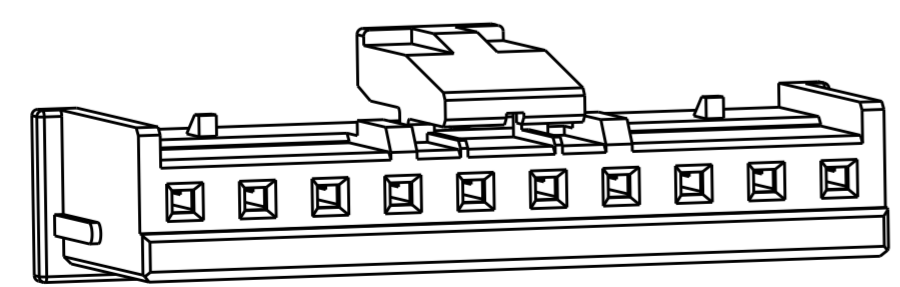

THIS DRAWING IS A CONTROLLED DOCUMENT. DWN: JR RUTH 09SEP2016
 CHK: TOM MICHIELUTTI 27FEB14
 APVD: TOM MICHIELUTTI 27FEB14

STE TE Connectivity

NAME: ECONOMY POWER 2.5 TPA HOUSING

PRODUCT SPEC: 108-2418
 APPLICATION SPEC: 114-13315

SIZE: A2 CAGE CODE: - DRAWING NO: C-1969442 RESTRICTED TO: -
 SCALE: 7:1 SHEET 1 OF 1 REV A6

DIMENSIONS: mm TOLERANCES UNLESS OTHERWISE SPECIFIED:
 0 PLC ±
 1 PLC ±0.25
 2 PLC ±0.25
 3 PLC ±
 4 PLC ±
 ANGLES ±
 FINISH ±

MATERIAL: - WEIGHT: - Customer Drawing

Mouser Electronics

Authorized Distributor

Click to View Pricing, Inventory, Delivery & Lifecycle Information:

[TE Connectivity:](#)

[1-1969442-4](#)