

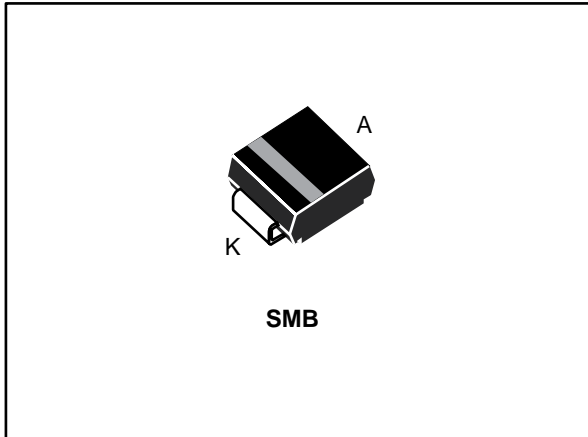

**Low voltage Transil™**

Datasheet - production data

**Description**

This is a Transil diode designed specifically to protect sensitive 3.3 V equipment against transient overvoltages.

Transil diodes provide high overvoltage protection by clamping action. Their instantaneous response to transient overvoltages make them particularly suited to protect voltage sensitive devices such as MOS technology and low voltage supplied ICs.

 TM: Transil is a trademark of STMicroelectronics

**Features**

- Peak pulse power 600 W (10/1000  $\mu$ s)
- Stand-off voltage 3.3 V
- Unidirectional type
- Low clamping factor
- Fast response time
- JEDEC registered package outline

# 1 Characteristics

**Table 1: Absolute maximum ratings (limiting values at  $T_{amb} = 25\text{ °C}$  unless otherwise specified)**

Symbol	Parameter		Value	Unit
$P_{pp}$	Peak pulse power dissipation <sup>(1)</sup>	$T_j \text{ initial} = T_{amb}$	600	W
$P$	Power dissipation on infinite heatsink	$T_{amb} = 50\text{ °C}$	6	W
$I_{FSM}$	Non repetitive surge peak forward current for unidirectional types	$t_p = 10\text{ ms}$ $T_j \text{ initial} = T_{amb}$	100	A
$T_{stg}$	Storage temperature range		-65 to +175	°C
$T_j$	Junction temperature range		-55 to +175	°C
$T_L$	Maximum lead temperature for soldering during 10 s.		260	°C

**Notes:**

<sup>(1)</sup>For a surge greater than the maximum values, the diode will fail in short-circuit.

**Table 2: Thermal resistances**

Symbol	Parameter	Value	Unit
$R_{th(j-l)}$	Junction to leads	20	°C/W
$R_{th(j-a)}$	Junction to ambient on printed circuit on recommended pad layout	100	°C/W

**Figure 1: Electrical characteristics (definitions)**

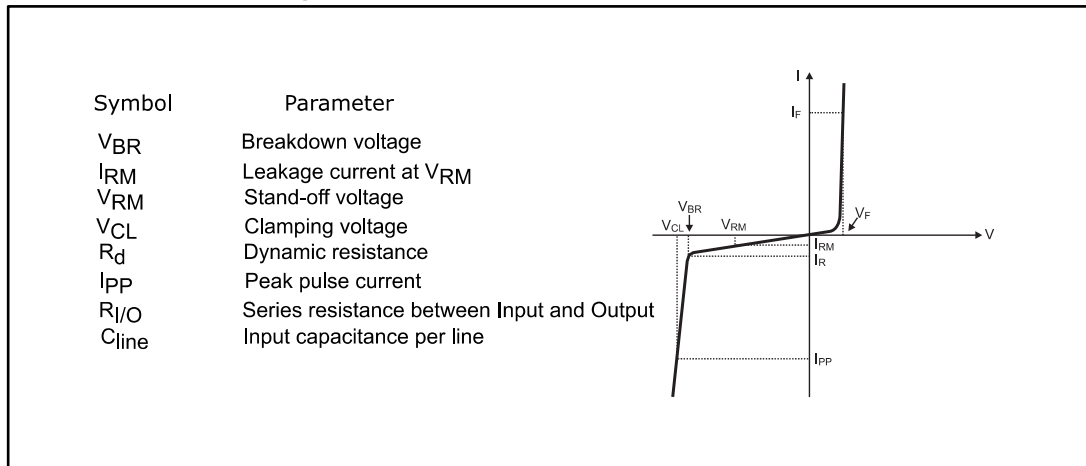

**Table 3: Electrical characteristics ( $T_{amb} = 25\text{ °C}$ )**

Type	$I_{RM}$ at $V_{RM}$		$V_{BR}$ at $I_R$ <sup>(1)</sup>		$V_{CL}$ at $I_{PP}$ 10/1000 $\mu$ s		$V_{CL}$ at $I_{PP}$ 8/20 $\mu$ s		$\alpha T$ <sup>(2)</sup>	$C$ <sup>(3)</sup>
	Max.		Min.		Max.		Max.		Max.	Typ.
	$\mu$ A	V	V	mA	V	A	V	A	$10^{-4}/\text{°C}$	pF
SMLVT3V3	200	3.3	4.1	1	7.3	50	10.3	200	-5.3	5200

**Notes:**

<sup>(1)</sup>Pulse test :  $t_p < 50\text{ ms}$

<sup>(2)</sup> $V_{BR} = \alpha T \times (T_{amb} - 25) \times V_{BR}(25\text{ °C})$

<sup>(3)</sup> $V_R = 0\text{ V}$ ,  $F = 1\text{ MHz}$

# 1.1 Characteristics (curves)

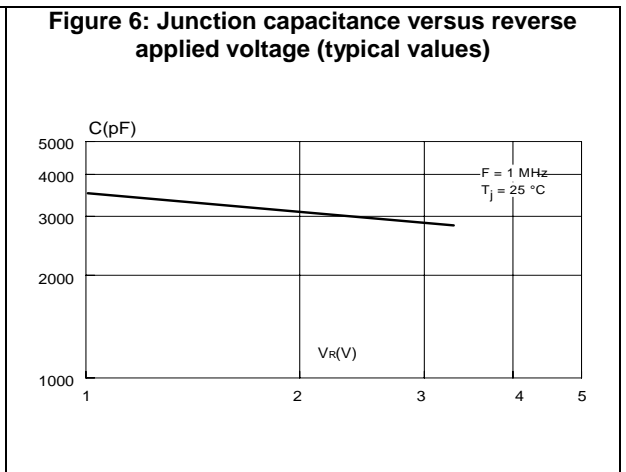
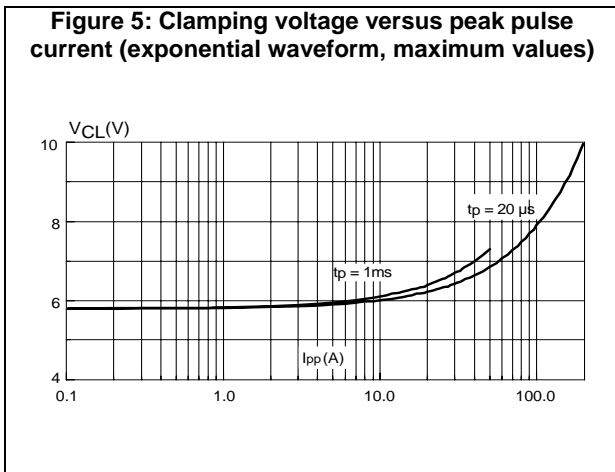
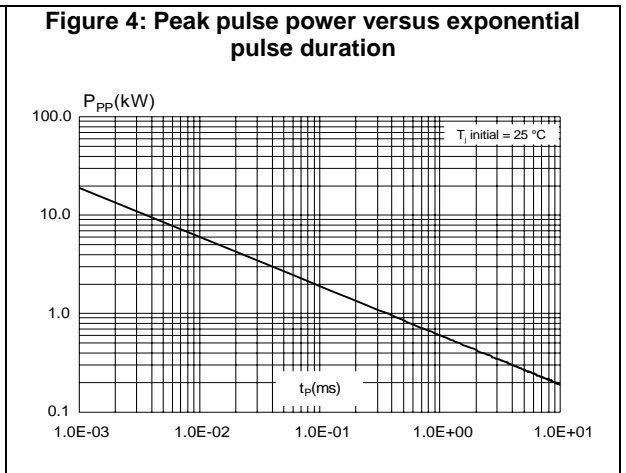
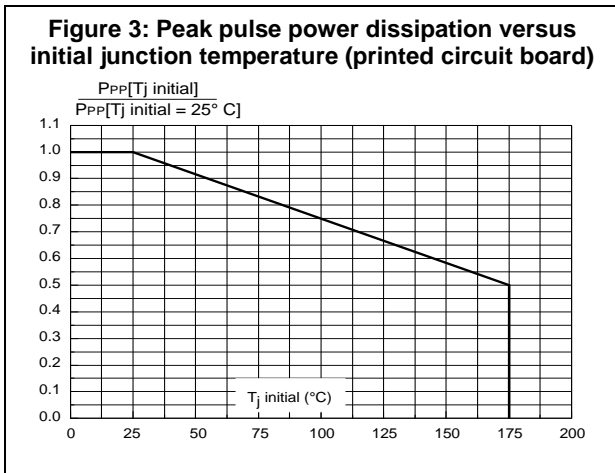
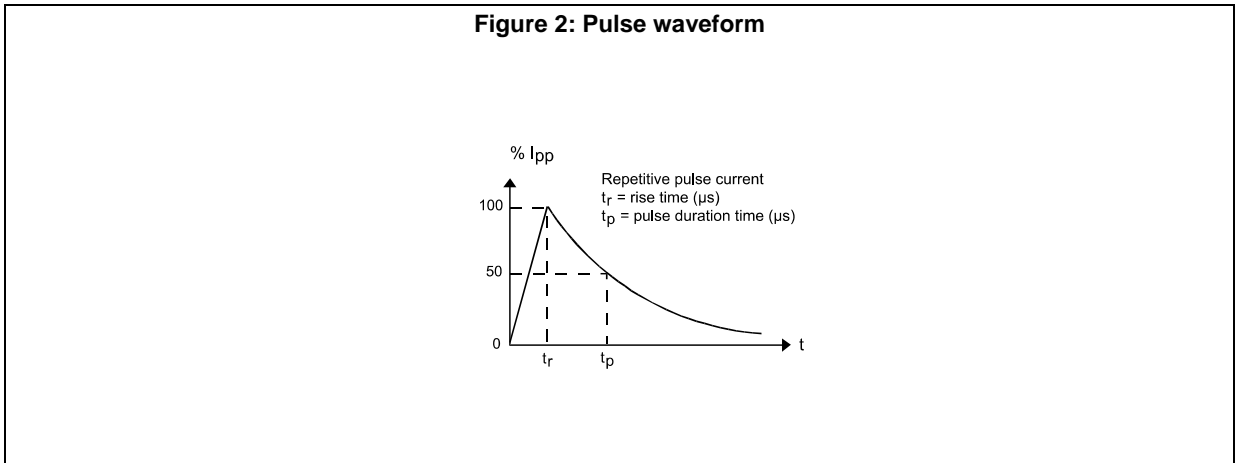

Figure 7: Peak forward voltage drop versus peak forward current (typical values)

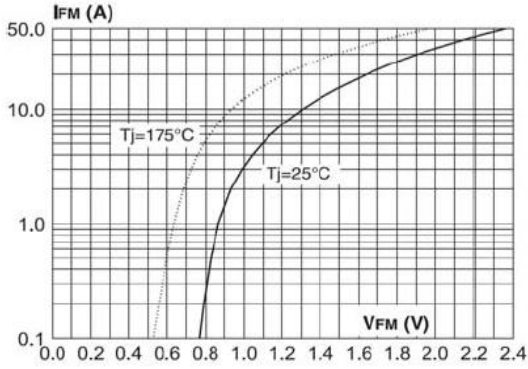

Figure 8: Transient thermal impedance, junction to ambient, versus pulse duration (PCB - FR4)

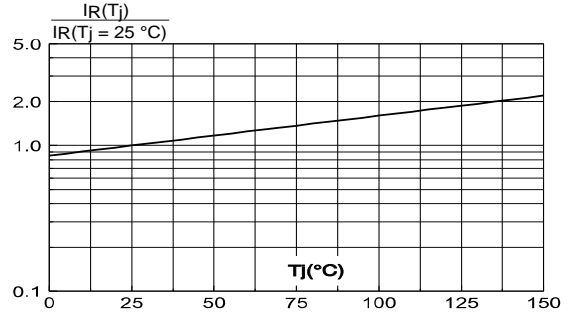
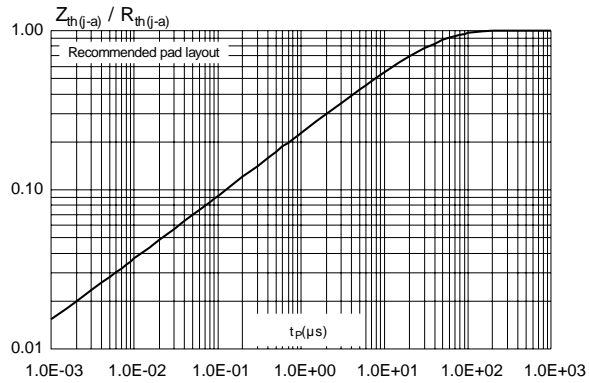

Figure 9: Relative variation of leakage current versus junction temperature



## 2 Package information

In order to meet environmental requirements, ST offers these devices in different grades of ECOPACK® packages, depending on their level of environmental compliance. ECOPACK® specifications, grade definitions and product status are available at: [www.st.com](http://www.st.com). ECOPACK® is an ST trademark.

- Case: JEDEC DO-214AA molded plastic over Planar junction
- Epoxy meets UL94, V0
- RoHS compliant package

### 2.1 SMB package information

Figure 10: SMB package outline

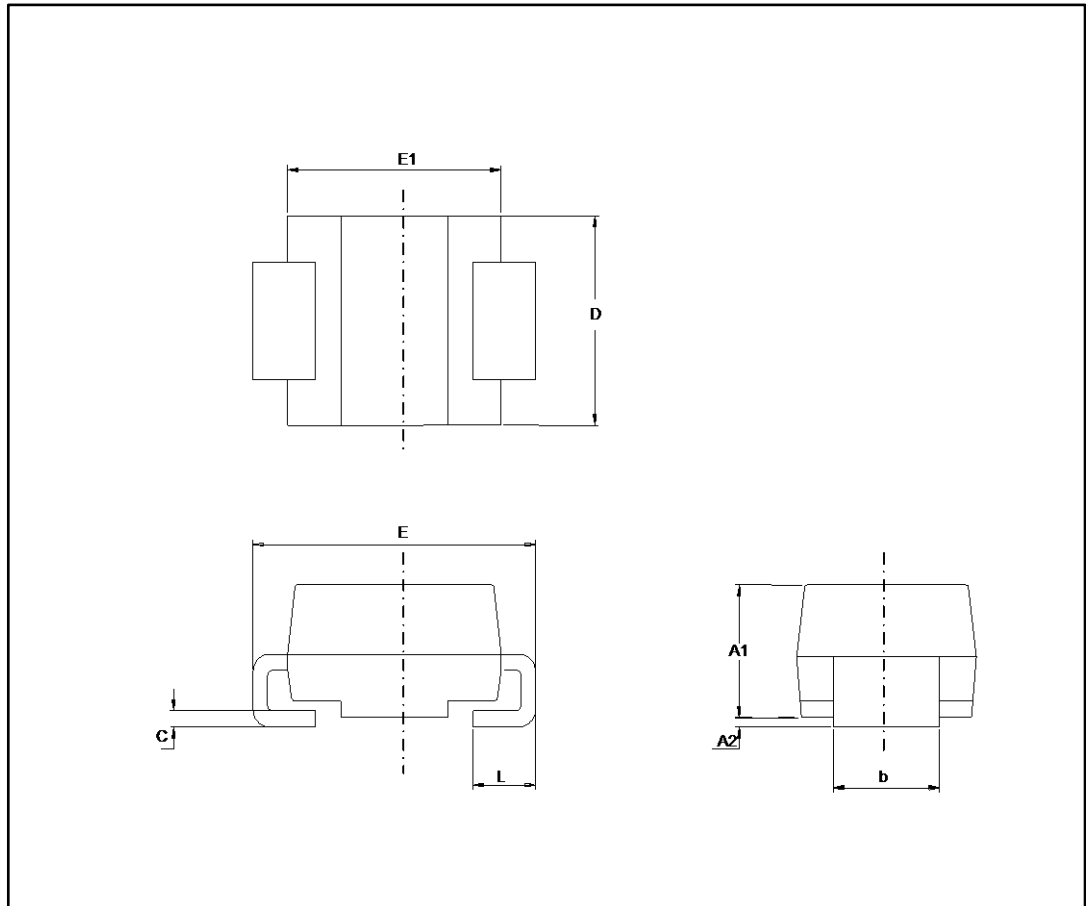

Table 4: SMB package mechanical data

Ref.	Dimensions			
	Millimeters		Inches	
	Min.	Max.	Min.	Max.
A1	1.90	2.45	0.0748	0.0965
A2	0.05	0.20	0.0020	0.0079
b	1.95	2.20	0.0768	0.0867
c	0.15	0.40	0.0059	0.0157
D	3.30	3.95	0.1299	0.1556
E	5.10	5.60	0.2008	0.2205
E1	4.05	4.60	0.1594	0.1811
L	0.75	1.50	0.0295	0.0591

Figure 11: SMB recommended Footprint

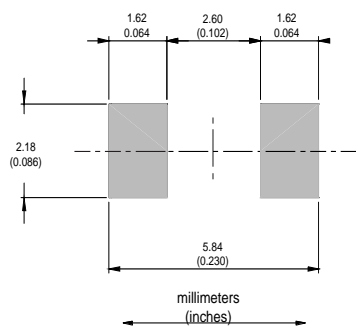
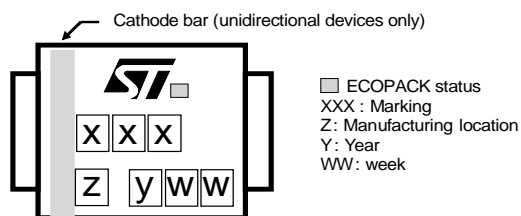

Figure 12: Marking layout



### 3 Ordering information

Figure 13: Ordering information scheme

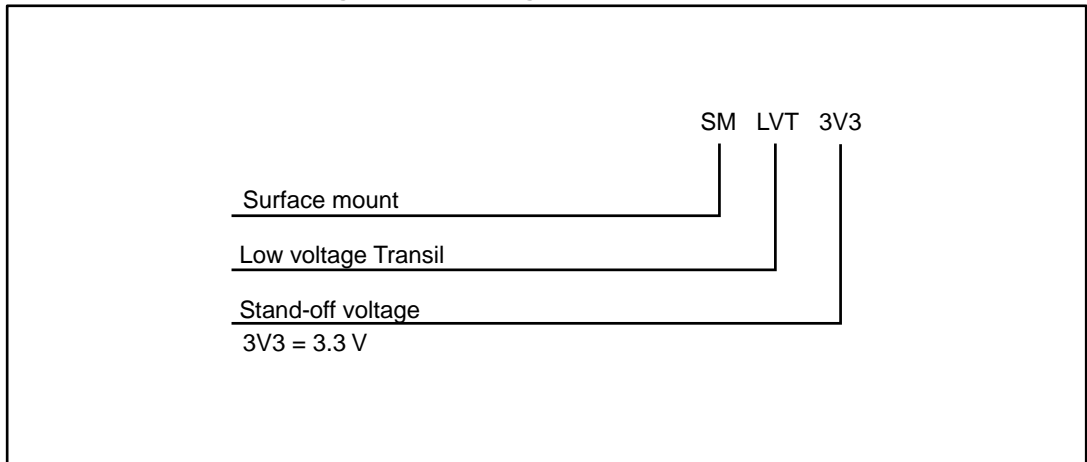

Table 5: Ordering information

Order code	Marking	Package	Weight	Base qty.	Delivery mode
SMLVT3V3	CD	SMB	0.12 g	2500	Tape and reel

### 4 Revision history

Table 6: Document revision history

Date	Revision	Changes
Aug-2001	2	Previous issue
25-Apr-2007	3	Reformatted to current standards. Added cathode bar marker in cover page graphics and <i>Figure 11</i> .
14-Sep-2011	4	Updated Junction temperature range in <i>Table 1</i> .
06-Apr-2017	5	Updated <i>Table 1</i> : " <i>Absolute maximum ratings (limiting values at Tamb = 25 °C unless otherwise specified)</i> ".

**IMPORTANT NOTICE – PLEASE READ CAREFULLY**

STMicroelectronics NV and its subsidiaries ("ST") reserve the right to make changes, corrections, enhancements, modifications, and improvements to ST products and/or to this document at any time without notice. Purchasers should obtain the latest relevant information on ST products before placing orders. ST products are sold pursuant to ST's terms and conditions of sale in place at the time of order acknowledgement.

Purchasers are solely responsible for the choice, selection, and use of ST products and ST assumes no liability for application assistance or the design of Purchasers' products.

No license, express or implied, to any intellectual property right is granted by ST herein.

Resale of ST products with provisions different from the information set forth herein shall void any warranty granted by ST for such product.

ST and the ST logo are trademarks of ST. All other product or service names are the property of their respective owners.

Information in this document supersedes and replaces information previously supplied in any prior versions of this document.

© 2017 STMicroelectronics – All rights reserved



# Mouser Electronics

Authorized Distributor

Click to View Pricing, Inventory, Delivery & Lifecycle Information:

[STMicroelectronics:](#)

[SMLVT3V3](#)