

LOW DROPOUT VOLTAGE REGULATOR

■ GENERAL DISCRIPTION

NJU7751/54 is a low dropout voltage regulator with ON/OFF control and Output shunt switch.

Advanced CMOS technology achieves high ripple rejection and ultra low quiescent current.

It is suitable for reset small micro controller and other logic chips.

■ PACKAGE OUTLINE



NJU7751/54F

■ FEATURES

- Ultra Low quiescent Current $I_q=20\mu\text{A typ.}(I_o=0\text{mA})$
- Output capacitor with 1.0uF ceramic capacitor
- Output Current $I_o(\text{max.})=100\text{mA}$
- High Precision Output $V_o\pm 1.0\%$
- Low Dropout Voltage 0.15V typ. ($I_o=60\text{mA}, V_o=3\text{V}$)
- With ON/OFF Control (Active High)
- With Output Shunt Switch
- Internal Short Circuit Current Limit
- CMOS Technology
- Package Outline SOT-23-5

■ PIN CONFIGURATION

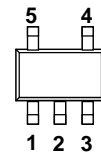

NJU7751/54F

PIN FUNCTION

- 1.CONTROL
- 2.GND
- 3.N.C.
4. V_{OUT}
5. V_{IN}

■ EQUIVALENT CIRCUIT

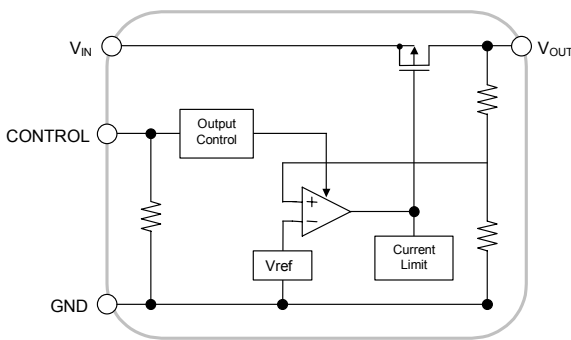

NJU7751

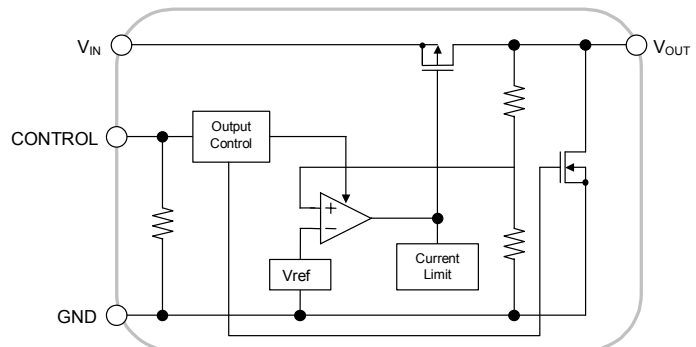

NJU7754

■ OUTPUT VOLTAGE RANK LIST

DEVICE NAME	V_{OUT}	DEVICE NAME	V_{OUT}
NJU775*F15	1.5V	NJU775*F28	2.8V
NJU775*F18	1.8V	NJU775*F03	3.0V
NJU775*F21	2.1V	NJU775*F32	3.2V
NJU775*F22	2.2V	NJU775*F33	3.3V
NJU775*F24	2.4V	NJU775*F05	5.0V
NJU775*F25	2.5V		

NJU7751/54

■ ABSOLUTE MAXIMUM RATINGS

(Ta=25°C)

PARAMETER	SYMBOL	RATINGS	UNIT	
Input Voltage	V _{IN}	+10	V	
Control Voltage	V _{CONT}	+10(*1)	V	
Power Dissipation	P _D	SOT-23-5	350(*2)	mW
			200(*3)	
Operating Temperature	Topr	-40 ~ +85	°C	
Storage Temperature	Tstg	-40 ~ +125	°C	
Output Sink Current at OFF-state(*4)	I _o	10	mA	

(*1) When input voltage is less than +10V, the absolute maximum control voltage is equal to the input voltage.

(*2): Mounted on glass epoxy board based on EIA/JEDEC. (114.3x76.2x1.6mm: 2Layers)

(*3): Device itself.

(*4): This maximum rating is applied to NJU7754.

■ Operating voltage

V_{IN}=+2.3 ~ +9V (In case of Vo<2.1V version)

■ ELECTRICAL CHARACTERISTICS

(V_{IN}=V_O+1V, C_{IN}=0.1μ F, C_O=1.0μ F (V_O≤2.0V:C_O=2.2μ F), Ta=25°C)

PARAMETER	SYMBOL	TEST CONDITION	MIN.	TYP.	MAX.	UNIT	
Output Voltage	V _O	I _o =30mA	-1.0%	-	+1.0%	V	
Input Voltage	V _{IN}		-	-	9	V	
Quiescent Current	I _Q	I _o =0mA, V _{CONT} =V _{IN} , Include I _{CONT}	-	20	40	μA	
Quiescent Current at Control OFF	I _{Q(OFF)}	V _{CONT} =0V	-	0.1	1	μA	
Output Current	I _o	V _O -0.3V	100	-	-	mA	
Short Circuit Limit	I _{LIM}	V _O =0V	-	40	-	mA	
Line Regulation	ΔV _O / ΔV _{IN}	V _{IN} = V _O +1V~V _O +6.0V (V _O <3.0V) V _{IN} = V _O +1V~9.0V (V _O ≥3.0V), I _o =30mA	-	-	0.20	%/V	
Load Regulation	ΔV _O / ΔV _O	I _o =0~100mA	-	-	0.03	%/mA	
Dropout Voltage(*5)	ΔV _{LO}	I _o =60mA	2.1V≤V _O ≤2.4V	-	0.20	0.27	V
			2.5V≤V _O ≤2.7V	-	0.18	0.25	V
			2.8V≤V _O ≤3.3V	-	0.15	0.22	V
			3.4V≤V _O ≤5.0V	-	0.12	0.19	V
Ripple Rejection	RR	e _{in} =200mVrms, f=1kHz, I _o =10mA, V _O =3.0V Version	-	65	-	dB	
Average Temperature Coefficient of Output Voltage	ΔV _O / ΔTa	Ta=0~85°C, I _o =10mA	-	±100	-	ppm/°C	
Output Noise Voltage	V _{NO}	f=10Hz ~ 80kHz, I _o =10mA, V _O =3.0V Version	-	75	-	μVrms	
Pull-down Resistance	R _{CONT}		2	5	10	MΩ	
Control Voltage for ON-State	V _{CONT(ON)}		1.6	-	-	V	
Control Voltage for OFF-State(*6)	V _{CONT(OFF)}		-	-	0.3	V	
Pull-down Resistance at OFF-state	R _{O(OFF)}	V _{CONT} =0V (V _O =3.0V Version)	-	150	-	Ω	

(*5): The output voltage excludes under 2.1V.

(*6): This electrical characteristics is applied to NJU7754.

The above specification is a common specification for all voltages.

Therefore, it may be different from the individual specification for a specific output Voltage.

■ TEST CIRCUIT

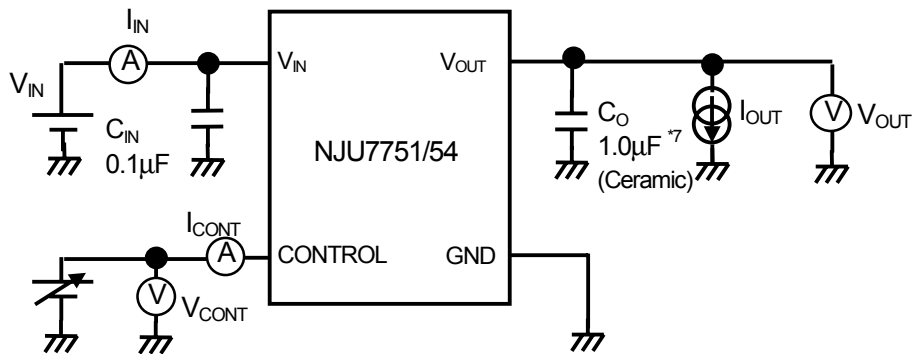

*7 : $V_O \leq 2.0V$ version, $C_O = 2.2\mu F$ (Ceramic)

■ TYPICAL APPLICATION

① In case that ON/OFF Control is not required:

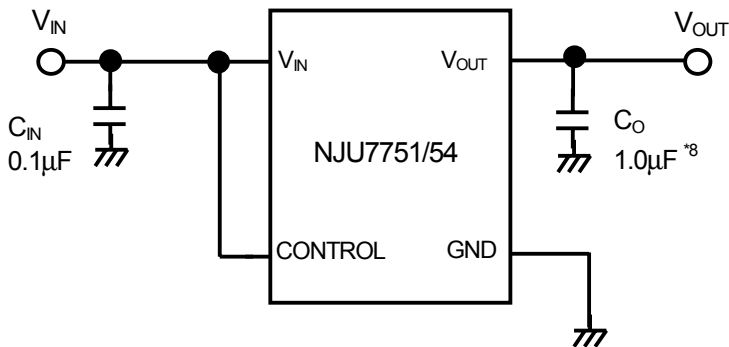

*8 : $V_O \leq 2.0V$ version, $C_O = 2.2\mu F$

Connect control terminal to V_{IN} terminal.

② In use of ON/OFF Control

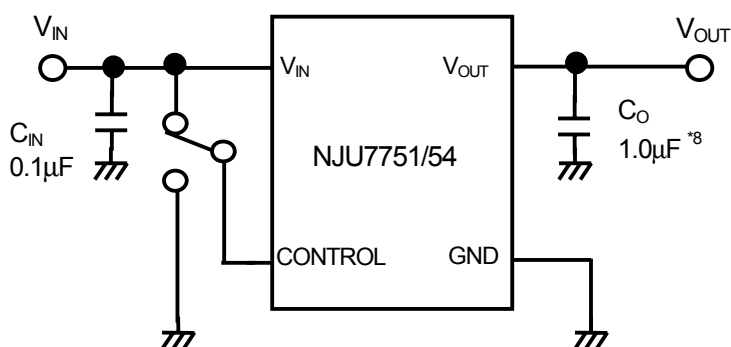

*8 : $V_O \leq 2.0V$ version, $C_O = 2.2\mu F$

State of control terminal:

- "H" → output is enabled.
- "L" or "open" → output is disabled.

NJU7751/54

POWER DISSIPATION vs. AMBIENT TEMPERATURE

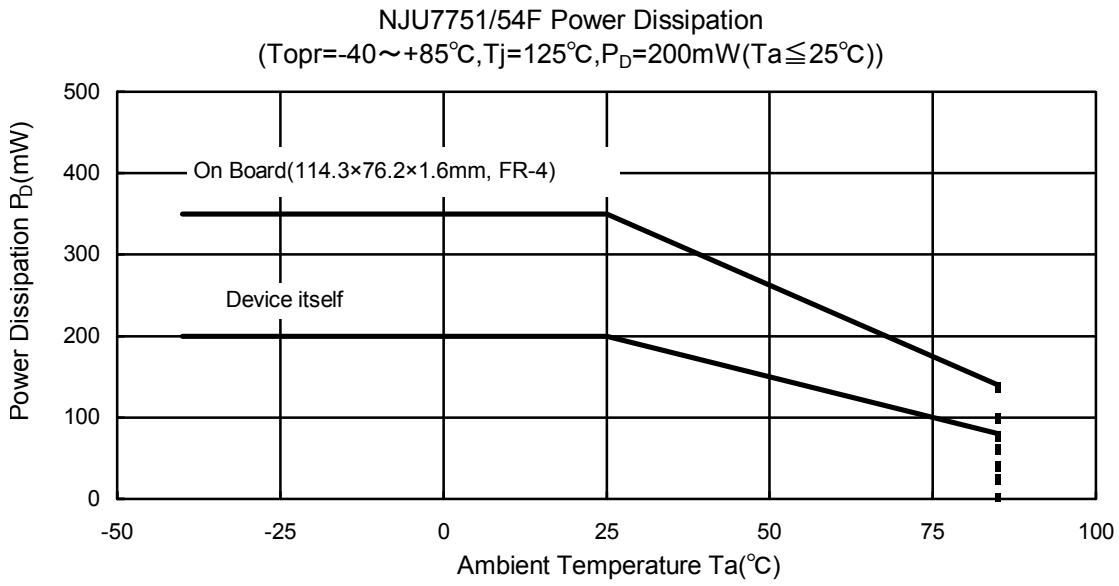

ELECTRICAL CHARACTERISTICS

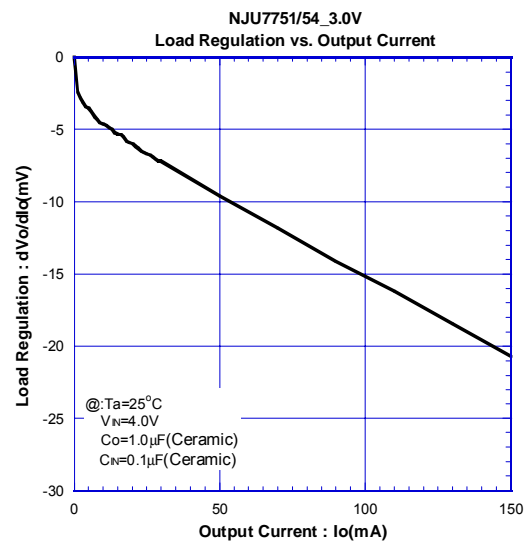
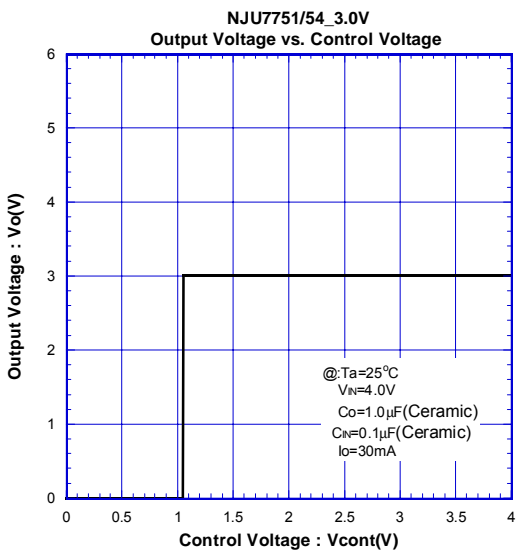
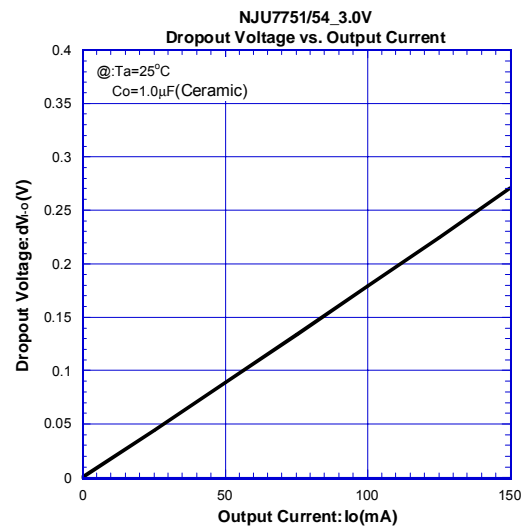
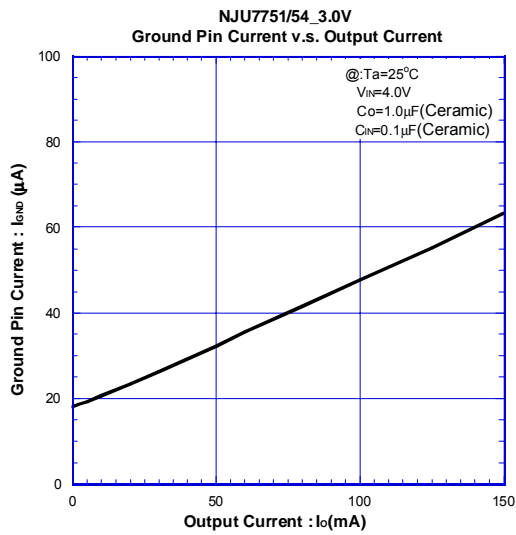
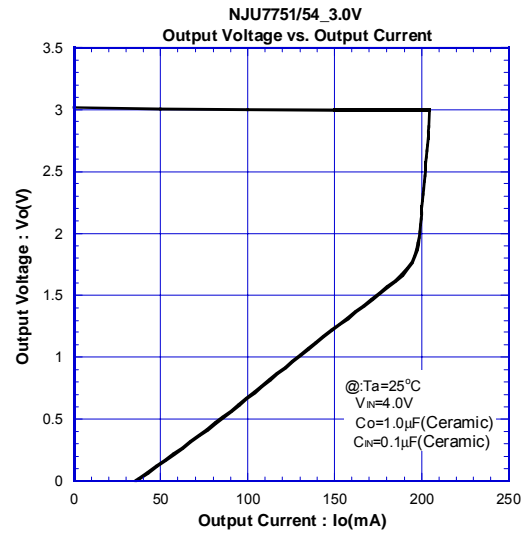
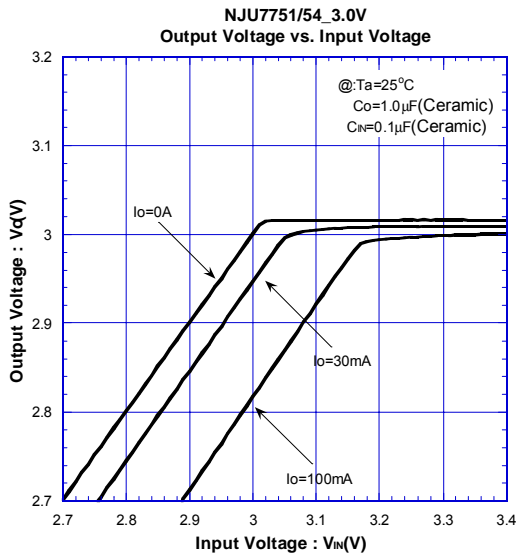

NJU7751/54

ELECTRICAL CHARACTERISTICS

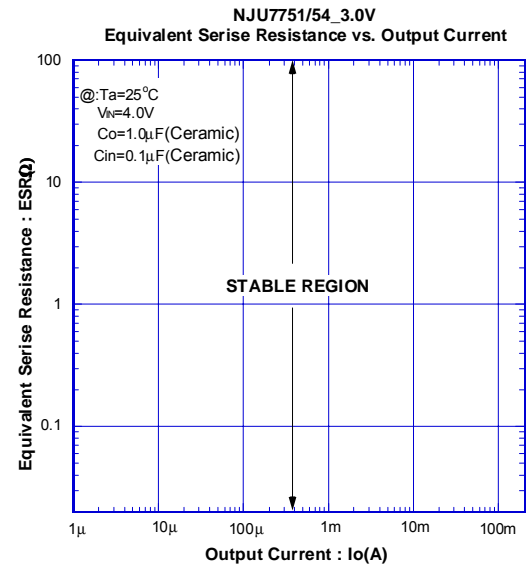
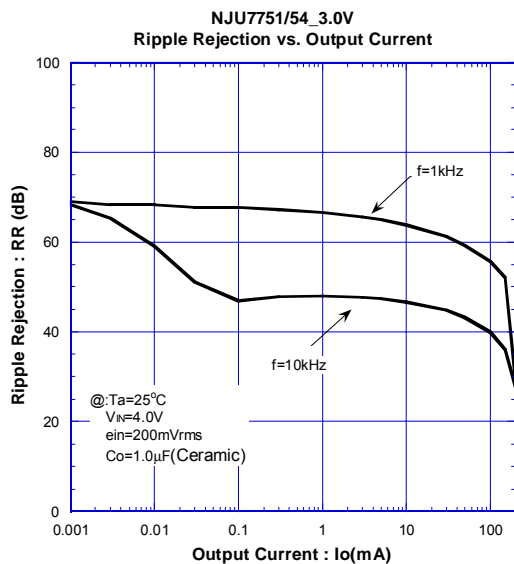
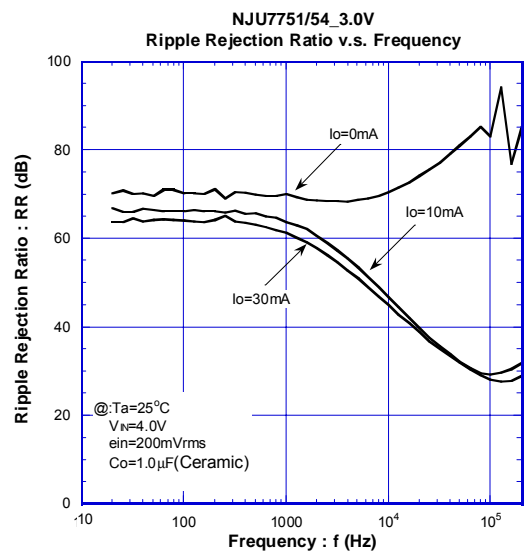
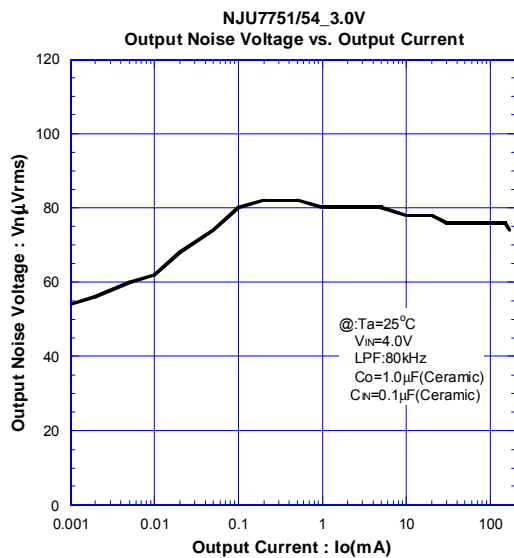
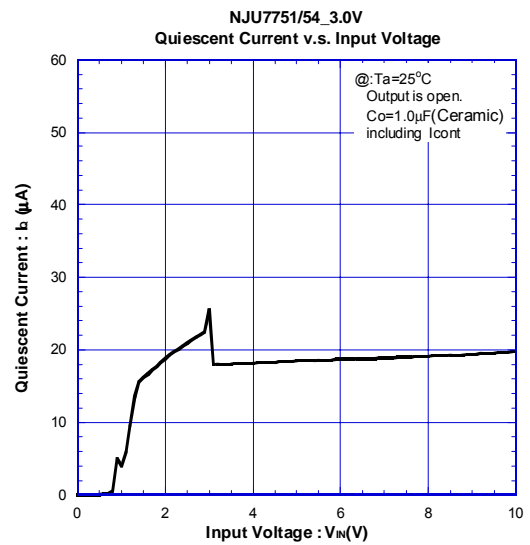
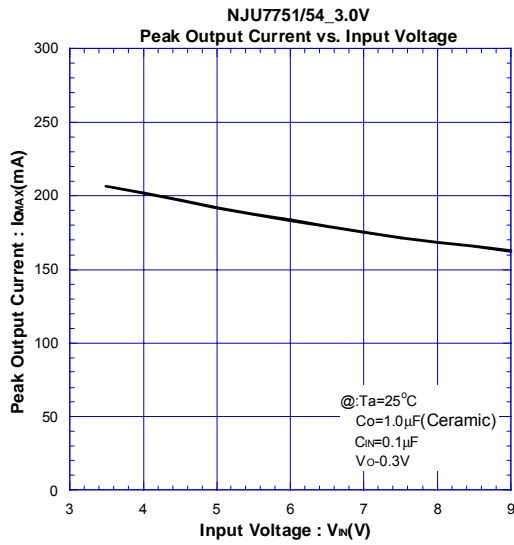

ELECTRICAL CHARACTERISTICS

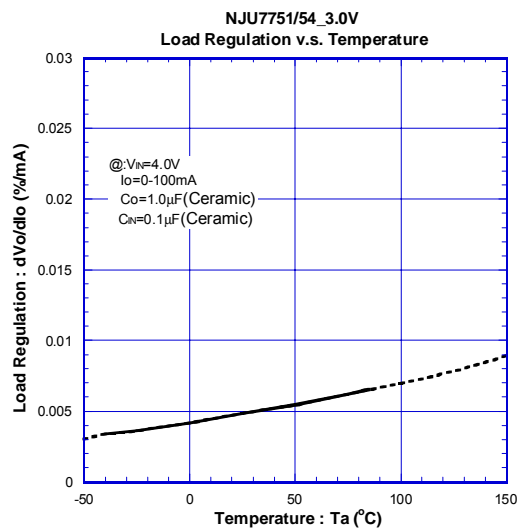
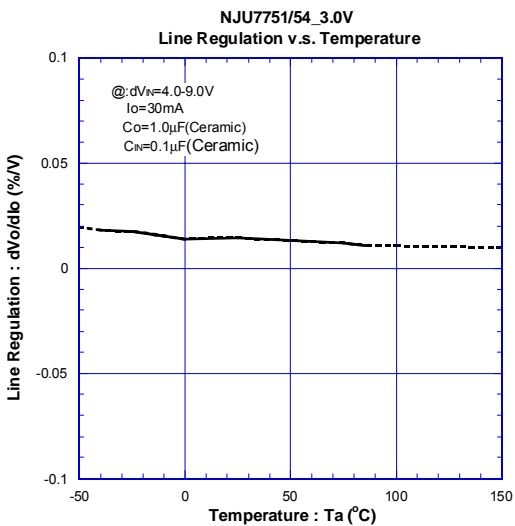
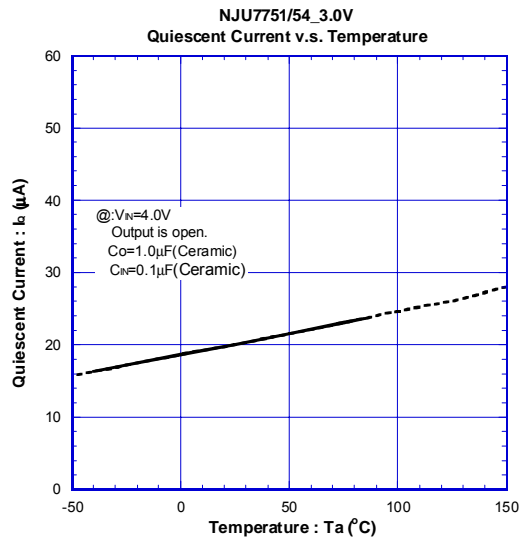
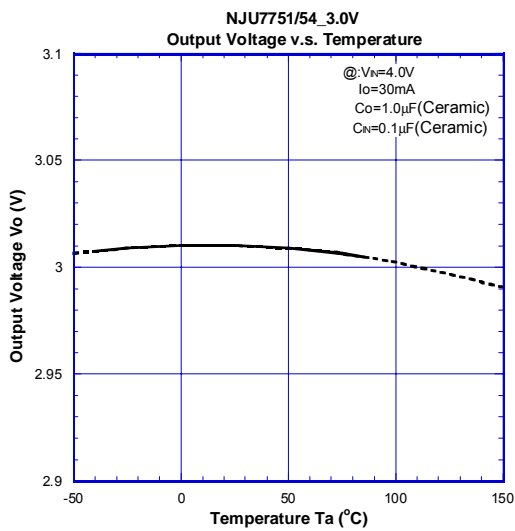
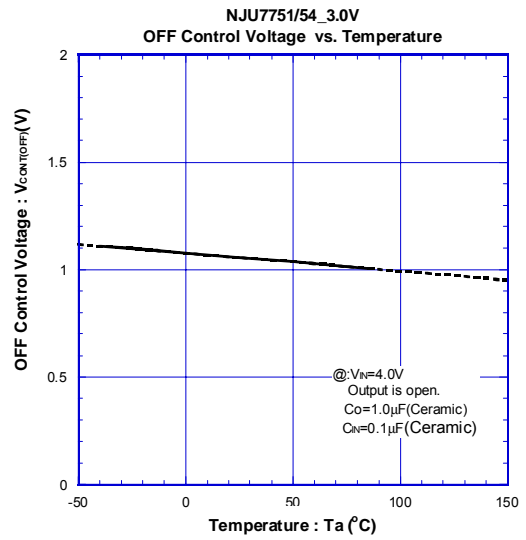
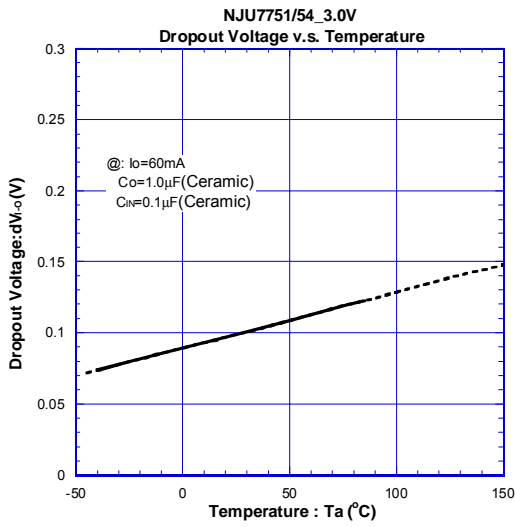

ELECTRICAL CHARACTERISTICS

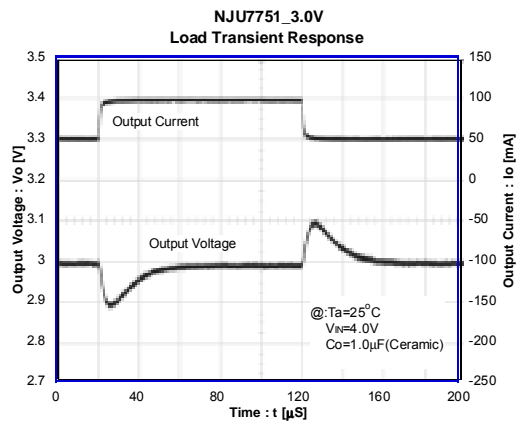
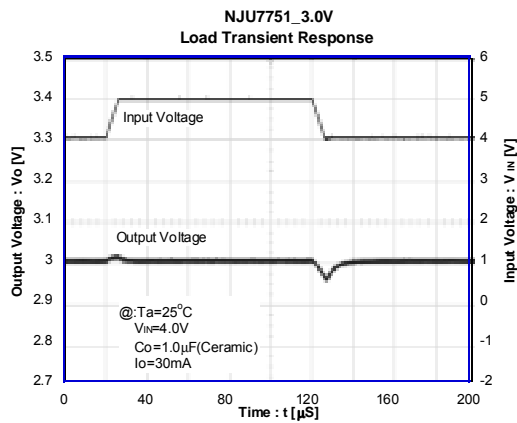
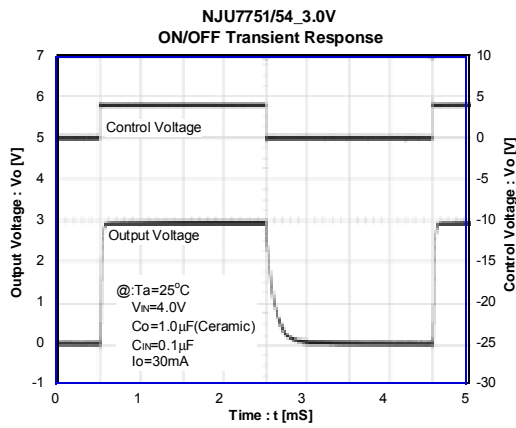
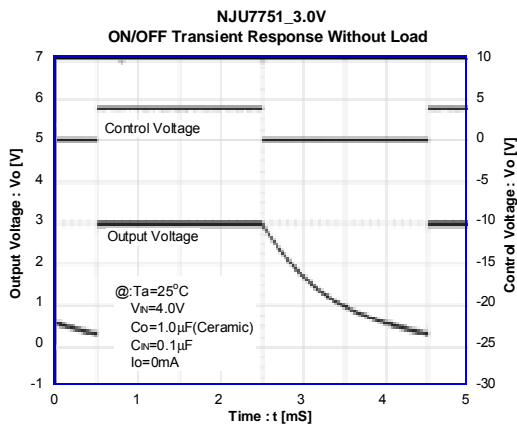
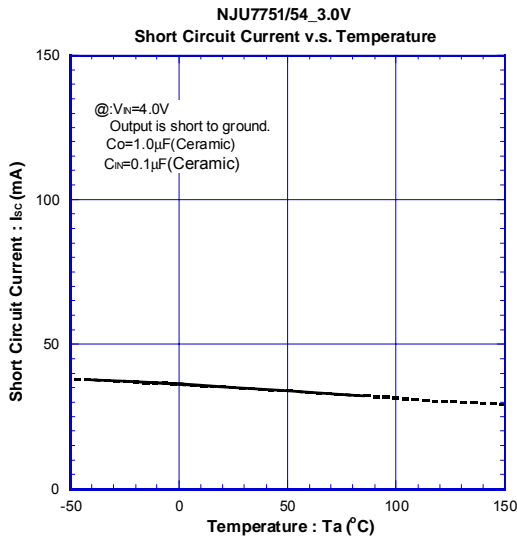

ELECTRICAL CHARACTERISTICS

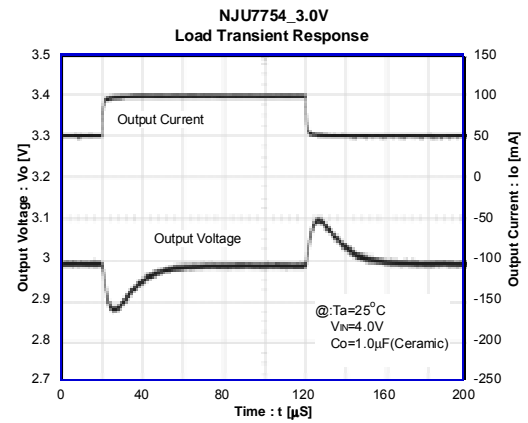
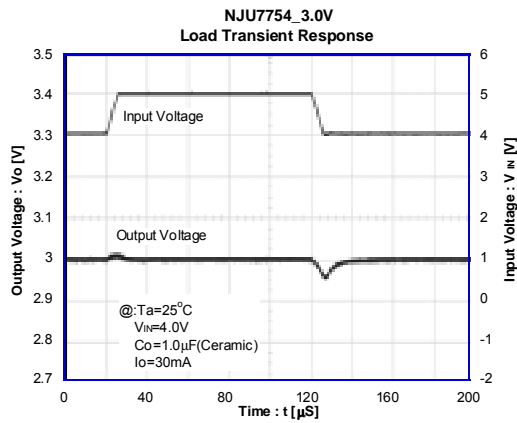
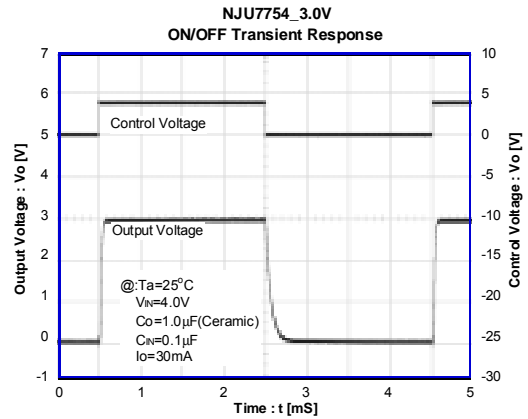
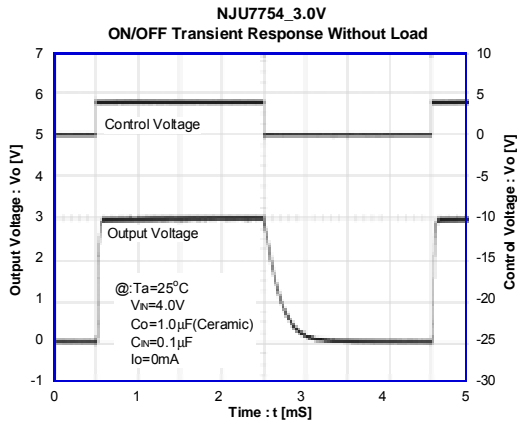

[CAUTION]

The specifications on this databook are only given for information, without any guarantee as regards either mistakes or omissions. The application circuits in this databook are described only to show representative usages of the product and not intended for the guarantee or permission of any right including the industrial rights.

Mouser Electronics

Authorized Distributor

Click to View Pricing, Inventory, Delivery & Lifecycle Information:

[NJR:](#)

[NJU7751F21-TE1](#) [NJU7754F25-TE1](#) [NJU7754F05-TE1](#) [NJU7751F25-TE1](#) [NJU7754F33-TE1](#) [NJU7754F21-TE1](#)
[NJU7751F05-TE2](#) [NJU7751F33-TE1](#) [NJU7754F03-TE1](#) [NJU7751F18-TE1](#) [NJU7751F03-TE2](#)