

**Features**

- Fit automatic placement equipment.
- Fit Compatible with infrared and vapor phase reflow solder process.
- Pb-free.
- RoHS compliant.

**Descriptions**

- For higher packing density .
- For minature applications .
- Yellow Diffusion Lens .
- Chip material : InGaN .
- Emitting color : White .

**Package Outline Dimensions**

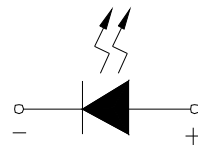
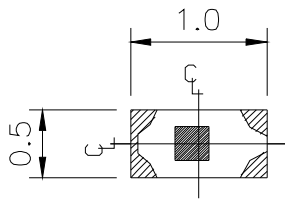

POLARITY

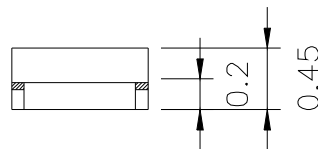

For Reflow Soldering

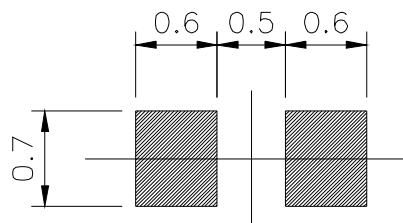
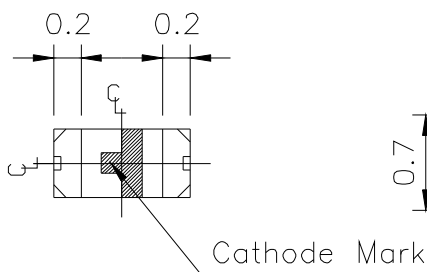

**Note:** The tolerances unless mentioned is  $\pm 0.1\text{mm}$  ,Unit = mm

**Absolute Maximum Ratings (Ta=25°C)**

Parameter	Symbol	Rating	Unit
Reverse Voltage	V <sub>R</sub>	5	V
Forward Current	I <sub>F</sub>	25	mA
Peak Forward Current (Duty 1/10 @1KHz)	I <sub>FP</sub>	100	mA
Power Dissipation	P <sub>d</sub>	110	mW
Electrostatic Discharge(HBM)	ESD	150	V
Operating Temperature	T <sub>opr</sub>	-40 ~ +85	°C
Storage Temperature	T <sub>stg</sub>	-40 ~ +90	°C
Soldering Temperature	T <sub>sol</sub>	Reflow Soldering : 260 °C for 10 sec. Hand Soldering : 350 °C for 3 sec.	

**Electro-Optical Characteristics (Ta=25°C)**

Parameter	Symbol	Min.	Typ.	Max.	Unit	Condition
Luminous Intensity	I <sub>v</sub>	57	----	112	mcd	I <sub>F</sub> =5mA
Viewing Angle	2 θ 1/2	----	130	----	deg	
Forward Voltage	V <sub>F</sub>	2.6	----	3.0	V	
Reverse Current	I <sub>R</sub>	----	----	50	μ A	V <sub>R</sub> =5V

**Bin Range Of Luminous Intensity & Forward Voltage**

Symbol	Bin Code	Min.	Max.	Unit	Condition
I <sub>v</sub>	P2	57	72	mcd	I <sub>F</sub> =5mA
	Q1	72	90		
	Q2	90	112		
V <sub>F</sub>	28	2.6	2.7	V	I <sub>F</sub> =5mA
	29	2.7	2.8		
	30	2.8	2.9		
	31	2.9	3.0		

Specific binning requirements- please contact our home office

**Notes:**

1. Tolerance of Luminous Intensity ±10%
2. Tolerance of Forward Voltage ±0.05V

### Chromaticity Coordinates Specifications for Bin Grading

Group	Bin Code	CIE_x	CIE_y	Condition
C	1	0.274	0.226	I <sub>F</sub> = 5mA
		0.274	0.258	
		0.294	0.286	
		0.294	0.254	
	2	0.274	0.258	
		0.274	0.291	
		0.294	0.319	
		0.294	0.286	
	3	0.294	0.254	
		0.294	0.286	
		0.314	0.315	
		0.314	0.282	
	4	0.294	0.286	
		0.294	0.319	
		0.314	0.347	
		0.314	0.315	

**Notes:**

- 1.The C.I.E. 1931 chromaticity diagram ( Tolerance  $\pm 0.01$  ).
- 2.The products are sensitive to static electricity and care must be fully taken when handling products.

## CIE Chromaticity Diagram

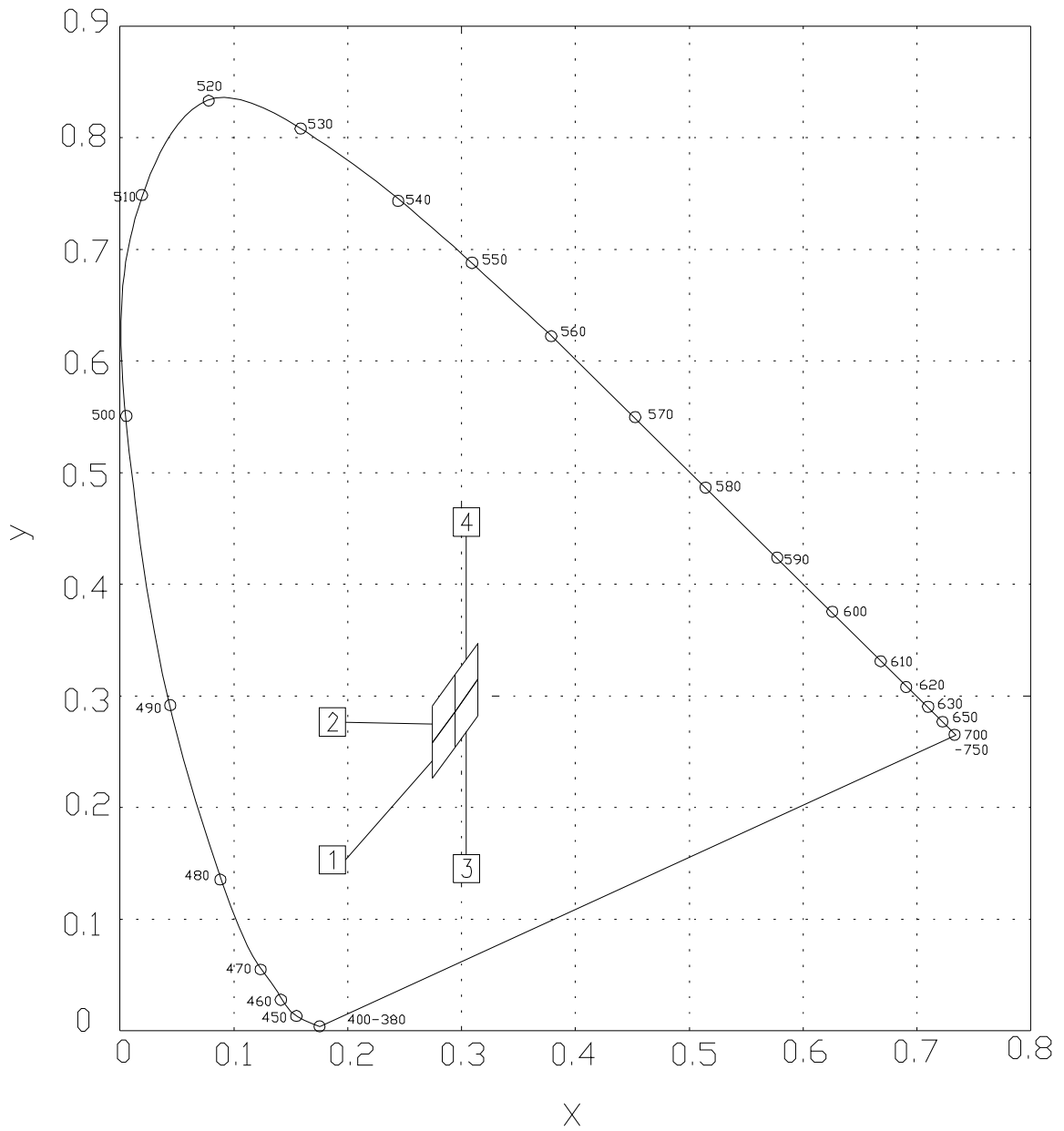

## Typical Electro-Optical Characteristics Curves

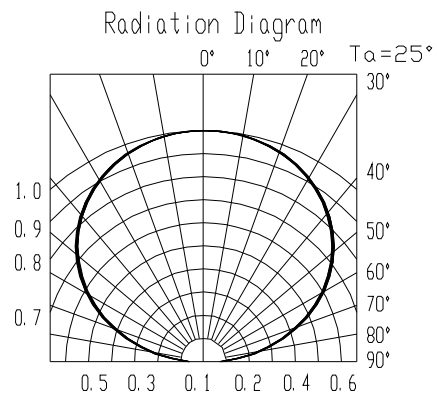
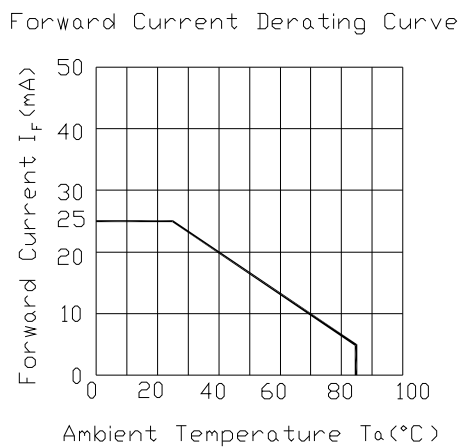
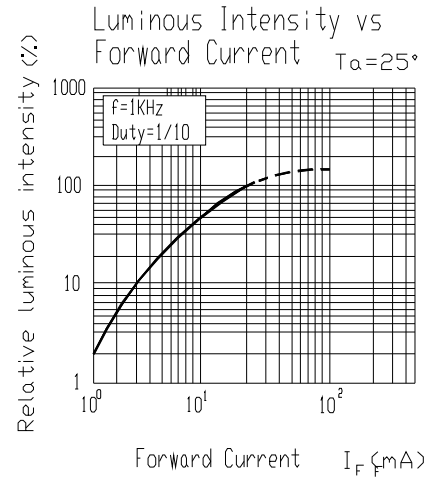
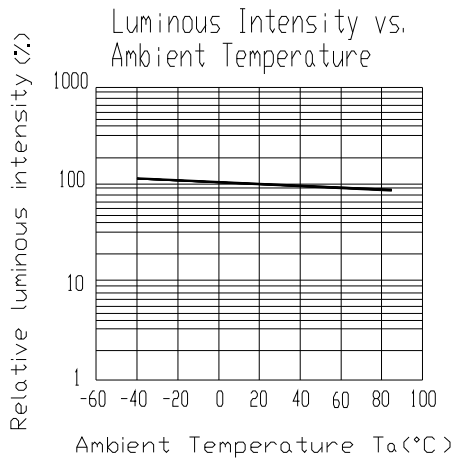
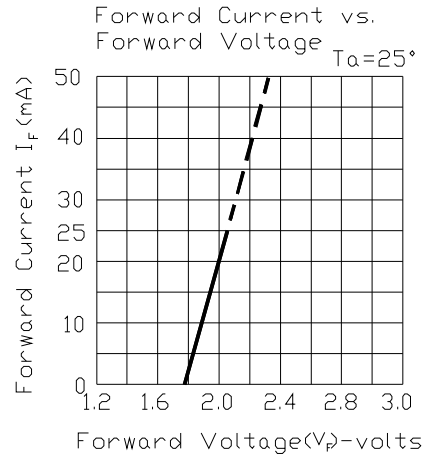
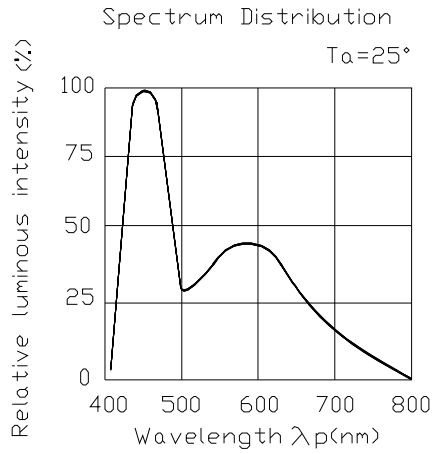

## Reel Dimensions

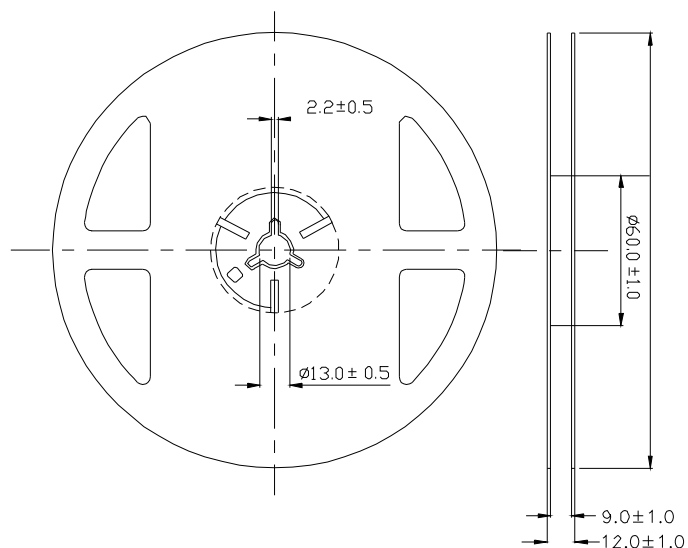

**Note:** The tolerances unless mentioned is  $\pm 0.1$ mm ,Unit = mm

**Carrier Tape Dimensions: Loaded quantity 3000 PCS per reel**

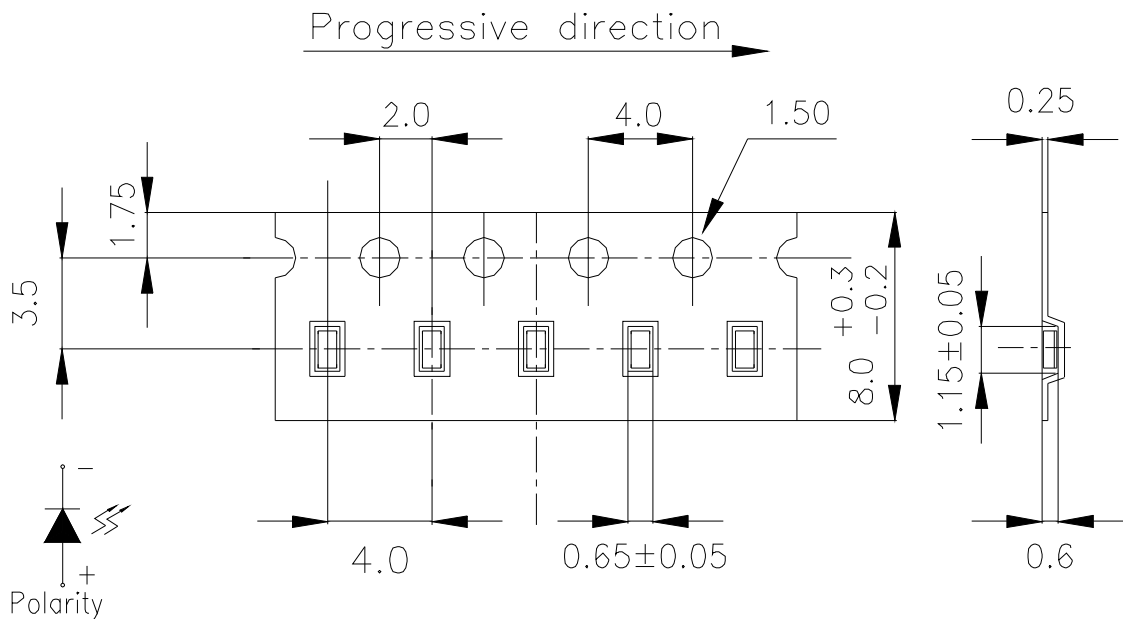

**Note:** The tolerances unless mentioned is  $\pm 0.1\text{mm}$ , Unit = mm

**Moisture Resistant Packaging**

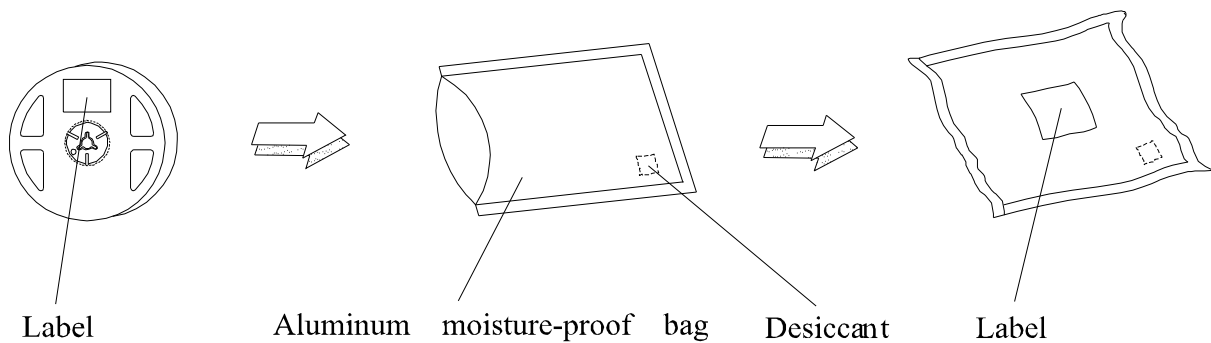



## Soldering Condition

### 1. Pb-free solder temperature profile

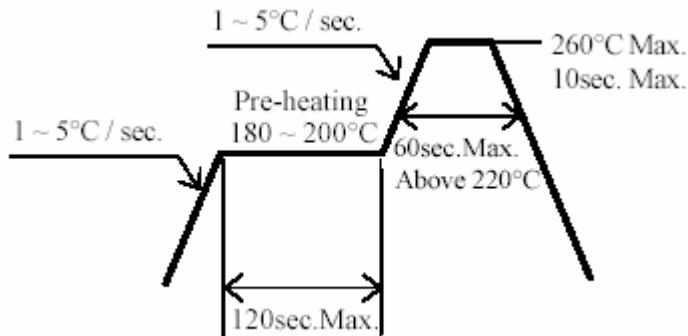

2. Reflow soldering should not be done more than two times.
- 3 When soldering, do not put stress on the LEDs during heating.
- 4 After soldering, do not warp the circuit board.

### Soldering Iron

Each terminal is to go to the tip of soldering iron temperature less than 350°C for 3 seconds within once in less than the soldering iron capacity 25W. Leave two seconds and more intervals, and do soldering of each terminal. Be careful because the damage of the product is often started at the time of the hand solder.

# Mouser Electronics

Authorized Distributor

Click to View Pricing, Inventory, Delivery & Lifecycle Information:

VCC:

[VAOL-S4WR4](#)