

Single and Dual Precision, 17 MHz, Low Noise, CMOS Input Amplifiers

Check for Samples: [LMP7711](#)

FEATURES

- Unless Otherwise Noted, Typical Values at $V_S = 5V$.
- Input Offset Voltage $\pm 150 \mu V$ (Max)
- Input Bias Current 100 fA
- Input Voltage Noise 5.8 nV/ \sqrt{Hz}
- Gain Bandwidth Product 17 MHz
- Supply Current (LMP7711) 1.15 mA
- Supply Current (LMP7712) 1.30 mA
- Supply Voltage Range 1.8V to 5.5V
- THD+N @ $f = 1 \text{ kHz}$ 0.001%
- Operating Temperature Range $-40^\circ C$ to $125^\circ C$
- Rail-to-rail Output Swing
- Space Saving SOT Package (LMP7711)
- 10-pin VSSOP Package (LMP7712)

APPLICATIONS

- Active Filters and Buffers
- Sensor Interface Applications
- Transimpedance Amplifiers

DESCRIPTION

The LMP7711/LMP7712 are single and dual low noise, low offset, CMOS input, rail-to-rail output precision amplifiers with a high gain bandwidth product and an enable pin. The LMP7711/LMP7712 are part of the LMP™ precision amplifier family and are ideal for a variety of instrumentation applications.

Utilizing a CMOS input stage, the LMP7711/LMP7712 achieve an input bias current of 100 fA, an input referred voltage noise of 5.8 nV/ \sqrt{Hz} , and an input offset voltage of less than $\pm 150 \mu V$. These features make the LMP7711/LMP7712 superior choices for precision applications.

Consuming only 1.15 mA of supply current, the LMP7711 offers a high gain bandwidth product of 17 MHz, enabling accurate amplification at high closed loop gains.

The LMP7711/LMP7712 have a supply voltage range of 1.8V to 5.5V, which makes these ideal choices for portable low power applications with low supply voltage requirements. In order to reduce the already low power consumption the LMP7711/LMP7712 have an enable function. Once in shutdown, the LMP7711/LMP7712 draw only 140 nA of supply current.

The LMP7711/LMP7712 are built with TI's advanced VIP50 process technology. The LMP7711 is offered in a 6-pin SOT package and the LMP7712 is offered in a 10-pin VSSOP.

TYPICAL PERFORMANCE

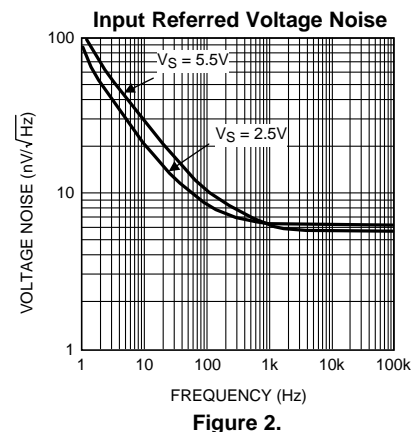
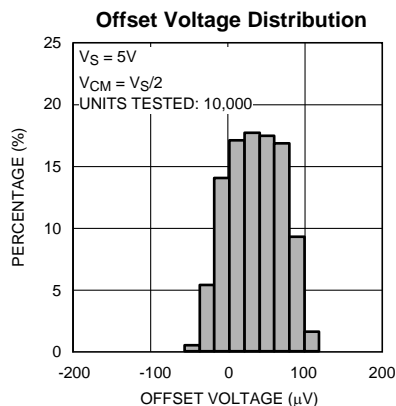

Please be aware that an important notice concerning availability, standard warranty, and use in critical applications of Texas Instruments semiconductor products and disclaimers thereto appears at the end of this data sheet.

LMP is a trademark of Texas Instruments.

All other trademarks are the property of their respective owners.

PRODUCTION DATA information is current as of publication date. Products conform to specifications per the terms of the Texas Instruments standard warranty. Production processing does not necessarily include testing of all parameters.

Copyright © 2005–2013, Texas Instruments Incorporated



These devices have limited built-in ESD protection. The leads should be shorted together or the device placed in conductive foam during storage or handling to prevent electrostatic damage to the MOS gates.

ABSOLUTE MAXIMUM RATINGS⁽¹⁾⁽²⁾

| | | |
|--------------------------------------|------------------------------------|------------------------|
| ESD Tolerance ⁽³⁾ | Human Body Model | 2000V |
| | Machine Model | 200V |
| | Charge-Device Model | 1000V |
| V_{IN} Differential | | ±0.3V |
| Supply Voltage ($V_S = V^+ - V^-$) | | 6.0V |
| Voltage on Input/Output Pins | | $V^+ +0.3V, V^- -0.3V$ |
| Storage Temperature Range | | -65°C to 150°C |
| Junction Temperature ⁽⁴⁾ | | +150°C |
| Soldering Information | Infrared or Convection (20 sec) | 235°C |
| | Wave Soldering Lead Temp. (10 sec) | 260°C |

- (1) Absolute Maximum Ratings indicate limits beyond which damage to the device may occur. Operating ratings indicate conditions for which the device is functional, but do not ensure specific performance limits. Electrical Characteristics state electrical specifications under particular test conditions which ensure specific performance limits. This assumes that the device is within the Operating Ratings. Specifications are not ensured for parameters where no limit is given, however, the typical value is a good indication of device performance.
- (2) If Military/Aerospace specified devices are required, please contact the Texas Instruments Sales Office/ Distributors for availability and specifications.
- (3) Human Body Model, applicable std. MIL-STD-883, Method 3015.7. Machine Model, applicable std. JESD22-A115-A (ESD MM std. of JEDEC) Field-Induced Charge-Device Model, applicable std. JESD22-C101-C (ESD FICDM std. of JEDEC).
- (4) The maximum power dissipation is a function of $T_{J(MAX)}$, θ_{JA} . The maximum allowable power dissipation at any ambient temperature is $P_D = (T_{J(MAX)} - T_A)/\theta_{JA}$. All numbers apply for packages soldered directly onto a PC Board.

OPERATING RATINGS⁽¹⁾

| | | |
|---|---|----------------|
| Temperature Range ⁽²⁾ | | -40°C to 125°C |
| Supply Voltage ($V_S = V^+ - V^-$) | $0^\circ\text{C} \leq T_A \leq 125^\circ\text{C}$ | 1.8V to 5.5V |
| | $-40^\circ\text{C} \leq T_A \leq 125^\circ\text{C}$ | 2.0V to 5.5V |
| Package Thermal Resistance (θ_{JA}) ⁽²⁾ | 6-Pin SOT | 170°C/W |
| | 10-Pin VSSOP | 236°C/W |

- (1) Absolute Maximum Ratings indicate limits beyond which damage to the device may occur. Operating ratings indicate conditions for which the device is functional, but do not ensure specific performance limits. Electrical Characteristics state electrical specifications under particular test conditions which ensure specific performance limits. This assumes that the device is within the Operating Ratings. Specifications are not ensured for parameters where no limit is given, however, the typical value is a good indication of device performance.
- (2) The maximum power dissipation is a function of $T_{J(MAX)}$, θ_{JA} . The maximum allowable power dissipation at any ambient temperature is $P_D = (T_{J(MAX)} - T_A)/\theta_{JA}$. All numbers apply for packages soldered directly onto a PC Board.

2.5V ELECTRICAL CHARACTERISTICS

Unless otherwise noted, all limits are ensured for $T_A = 25^\circ\text{C}$, $V^+ = 2.5\text{V}$, $V^- = 0\text{V}$, $V_O = V_{CM} = V^+/2$, $V_{EN} = V^+$. **Boldface** limits apply at the temperature extremes.

| Symbol | Parameter | Conditions | Min ⁽¹⁾ | Typ ⁽²⁾ | Max ⁽¹⁾ | Units |
|-------------|--|--|--------------------|--------------------|--------------------|---------------------|
| V_{OS} | Input Offset Voltage | | | ±20 | ±180 ±480 | μV |
| TC V_{OS} | Input Offset Voltage Temperature Drift ⁽³⁾⁽⁴⁾ | LMP7711 | -1.75 | -1 | ±4 | μV/°C |
| | | LMP7712 | | | | |
| I_B | Input Bias Current | $V_{CM} = 1.0\text{V}^{(5)(4)}$ -40°C ≤ T_A ≤ 85°C | | 0.05 | 1 25 | pA |
| | | | | 0.05 | 1 100 | |
| I_{OS} | Input Offset Current | $V_{CM} = 1.0\text{V}^{(4)}$ | | 0.006 | 0.5 50 | pA |
| CMRR | Common Mode Rejection Ratio | $0\text{V} \leq V_{CM} \leq 1.4\text{V}$ | 83 80 | 100 | | dB |
| PSRR | Power Supply Rejection Ratio | $2.0\text{V} \leq V^+ \leq 5.5\text{V}$ $V^- = 0\text{V}$, $V_{CM} = 0$ | 85 80 | 100 | | dB |
| | | $1.8\text{V} \leq V^+ \leq 5.5\text{V}$ $V^- = 0\text{V}$, $V_{CM} = 0$ | 85 | 98 | | |
| CMVR | Common Mode Voltage Range | CMRR ≥ 80 dB CMRR ≥ 78 dB | -0.3 -0.3 | | 1.5 1.5 | V |
| A_{VOL} | Open Loop Voltage Gain | LMP7711, $V_O = 0.15$ to 2.2V $R_L = 2\text{ k}\Omega$ to $V^+/2$ | 88 82 | 98 | | dB |
| | | LMP7712, $V_O = 0.15$ to 2.2V $R_L = 2\text{ k}\Omega$ to $V^+/2$ | 84 80 | 92 | | |
| | | LMP7711, $V_O = 0.15$ to 2.2V $R_L = 10\text{ k}\Omega$ to $V^+/2$ | 92 88 | 114 | | |
| | | LMP7712, $V_O = 0.15$ to 2.2V $R_L = 10\text{ k}\Omega$ to $V^+/2$ | 90 86 | 95 | | |
| V_{OUT} | Output Voltage Swing High | $R_L = 2\text{ k}\Omega$ to $V^+/2$ | | 25 | 70 77 | mV from either rail |
| | | $R_L = 10\text{ k}\Omega$ to $V^+/2$ | | 20 | 60 66 | |
| | Output Voltage Swing Low | $R_L = 2\text{ k}\Omega$ to $V^+/2$ | | 30 | 70 73 | |
| | | $R_L = 10\text{ k}\Omega$ to $V^+/2$ | | 15 | 60 62 | |
| I_{OUT} | Output Current | Sourcing to V^- $V_{IN} = 200\text{ mV}^{(6)}$ | 36 30 | 52 | | mA |
| | | Sinking to V^+ $V_{IN} = -200\text{ mV}^{(6)}$ | 7.5 5.0 | 15 | | |
| I_S | Supply Current | LMP7711 Enable Mode $V_{EN} \geq 2.1$ | | 0.95 | 1.30 1.65 | mA |
| | | LMP7712 (per channel) Enable Mode $V_{EN} \geq 2.1$ | | 1.10 | 1.50 1.85 | |
| | | Shutdown Mode (per channel) $V_{EN} \leq 0.4$ | | 0.03 | 1 4 | μA |
| SR | Slew Rate | $A_V = +1$, Rising (10% to 90%) | | 8.3 | | V/μs |
| | | $A_V = +1$, Falling (90% to 10%) | | 10.3 | | |

- (1) Limits are 100% production tested at 25°C. Limits over the operating temperature range are ensured through correlations using the Statistical Quality Control (SQC) method.
- (2) Typical values represent the most likely parametric norm as determined at the time of characterization. Actual typical values may vary over time and will also depend on the application and configuration. The typical values are not tested and are not ensured on shipped production material.
- (3) Offset voltage average drift is determined by dividing the change in V_{OS} at the temperature extremes by the total temperature change.
- (4) This parameter is specified by design and/or characterization and is not tested in production.
- (5) Positive current corresponds to current flowing into the device.
- (6) The short circuit test is a momentary open loop test.

2.5V ELECTRICAL CHARACTERISTICS (continued)

Unless otherwise noted, all limits are ensured for $T_A = 25^\circ\text{C}$, $V^+ = 2.5\text{V}$, $V^- = 0\text{V}$, $V_O = V_{\text{CM}} = V^+/2$, $V_{\text{EN}} = V^+$. **Boldface** limits apply at the temperature extremes.

| Symbol | Parameter | Conditions | Min ⁽¹⁾ | Typ ⁽²⁾ | Max ⁽¹⁾ | Units |
|------------------|--------------------------------------|---|--------------------|--------------------|--------------------|------------------------------|
| GBW | Gain Bandwidth | | | 14 | | MHz |
| e_n | Input Referred Voltage Noise Density | $f = 400\text{ Hz}$ | | 6.8 | | $\text{nV}/\sqrt{\text{Hz}}$ |
| | | $f = 1\text{ kHz}$ | | 5.8 | | |
| i_n | Input Referred Current Noise Density | $f = 1\text{ kHz}$ | | 0.01 | | $\text{pA}/\sqrt{\text{Hz}}$ |
| t_{on} | Turn-on Time | | | 140 | | ns |
| t_{off} | Turn-off Time | | | 1000 | | ns |
| V_{EN} | Enable Pin Voltage Range | Enable Mode | 2.1 | 2 - 2.5 | | V |
| | | Shutdown Mode | | 0 - 0.5 | 0.4 | |
| I_{EN} | Enable Pin Input Current | $V_{\text{EN}} = 2.5\text{V}^{(5)}$ | | 1.5 | 3.0 | μA |
| | | $V_{\text{EN}} = 0\text{V}^{(5)}$ | | 0.003 | 0.1 | |
| THD+N | Total Harmonic Distortion + Noise | $f = 1\text{ kHz}$, $A_V = 1$, $R_L = 100\text{ k}\Omega$ $V_O = 0.9\text{ V}_{\text{PP}}$ | | 0.003 | | % |
| | | $f = 1\text{ kHz}$, $A_V = 1$, $R_L = 600\Omega$ $V_O = 0.9\text{ V}_{\text{PP}}$ | | 0.004 | | |

5V ELECTRICAL CHARACTERISTICS

Unless otherwise noted, all limits are ensured for $T_A = 25^\circ\text{C}$, $V^+ = 5\text{V}$, $V^- = 0\text{V}$, $V_{\text{CM}} = V^+/2$, $V_{\text{EN}} = V^+$. **Boldface** limits apply at the temperature extremes.

| Symbol | Parameter | Conditions | Min ⁽¹⁾ | Typ ⁽²⁾ | Max ⁽¹⁾ | Units |
|--------------------|--|--|---|--------------------|--|------------------------------|
| V_{OS} | Input Offset Voltage | | | ± 10 | ± 150 ± 450 | μV |
| TC V_{OS} | Input Offset Voltage Temperature Drift ⁽³⁾⁽⁴⁾ | LMP7711 | -1.75 | -1 | ± 4 | $\mu\text{V}/^\circ\text{C}$ |
| | | LMP7712 | | | | |
| I_{B} | Input Bias Current | $V_{\text{CM}} = 2.0\text{V}^{(5)(4)}$ | $-40^\circ\text{C} \leq T_A \leq 85^\circ\text{C}$ | 0.1 | 1 25 | pA |
| | | | $-40^\circ\text{C} \leq T_A \leq 125^\circ\text{C}$ | 0.1 | 1 100 | |
| I_{OS} | Input Offset Current | $V_{\text{CM}} = 2.0\text{V}^{(4)}$ | | 0.01 | 0.5 50 | pA |
| CMRR | Common Mode Rejection Ratio | $0\text{V} \leq V_{\text{CM}} \leq 3.7\text{V}$ | 85 82 | 100 | | dB |
| PSRR | Power Supply Rejection Ratio | $2.0\text{V} \leq V^+ \leq 5.5\text{V}$ $V^- = 0\text{V}$, $V_{\text{CM}} = 0$ | 85 80 | 100 | | dB |
| | | $1.8\text{V} \leq V^+ \leq 5.5\text{V}$ $V^- = 0\text{V}$, $V_{\text{CM}} = 0$ | 85 | 98 | | |
| CMVR | Common Mode Voltage Range | CMRR $\geq 80\text{ dB}$ CMRR $\geq 78\text{ dB}$ | -0.3 -0.3 | | 4 4 | V |

- (1) Limits are 100% production tested at 25°C . Limits over the operating temperature range are ensured through correlations using the Statistical Quality Control (SQC) method.
- (2) Typical values represent the most likely parametric norm as determined at the time of characterization. Actual typical values may vary over time and will also depend on the application and configuration. The typical values are not tested and are not ensured on shipped production material.
- (3) Offset voltage average drift is determined by dividing the change in V_{OS} at the temperature extremes by the total temperature change.
- (4) This parameter is specified by design and/or characterization and is not tested in production.
- (5) Positive current corresponds to current flowing into the device.

5V ELECTRICAL CHARACTERISTICS (continued)

Unless otherwise noted, all limits are ensured for $T_A = 25^\circ\text{C}$, $V^+ = 5\text{V}$, $V^- = 0\text{V}$, $V_{\text{CM}} = V^+/2$, $V_{\text{EN}} = V^+$. **Boldface** limits apply at the temperature extremes.

| Symbol | Parameter | Conditions | Min ⁽¹⁾ | Typ ⁽²⁾ | Max ⁽¹⁾ | Units |
|------------------|--------------------------------------|---|--------------------|--------------------|---------------------|------------------------------|
| A _{VOL} | Open Loop Voltage Gain | LMP7711, $V_O = 0.3$ to 4.7V $R_L = 2\text{ k}\Omega$ to $V^+/2$ | 88 82 | 107 | | dB |
| | | LMP7712, $V_O = 0.3$ to 4.7V $R_L = 2\text{ k}\Omega$ to $V^+/2$ | 84 80 | 90 | | |
| | | LMP7711, $V_O = 0.3$ to 4.7V $R_L = 10\text{ k}\Omega$ to $V^+/2$ | 92 88 | 114 | | |
| | | LMP7712, $V_O = 0.3$ to 4.7V $R_L = 10\text{ k}\Omega$ to $V^+/2$ | 90 86 | 95 | | |
| V _{OUT} | Output Voltage Swing High | $R_L = 2\text{ k}\Omega$ to $V^+/2$ | | 32 | 70 77 | mV from either rail |
| | | $R_L = 10\text{ k}\Omega$ to $V^+/2$ | | 22 | 60 66 | |
| | Output Voltage Swing Low | $R_L = 2\text{ k}\Omega$ to $V^+/2$ (LMP7711) | | 42 | 70 73 | |
| | | $R_L = 2\text{ k}\Omega$ to $V^+/2$ (LMP7712) | | 50 | 75 78 | |
| | $R_L = 10\text{ k}\Omega$ to $V^+/2$ | | 20 | 60 62 | | |
| I _{OUT} | Output Current | Sourcing to V^- $V_{\text{IN}} = 200\text{ mV}^{(6)}$ | 46 38 | 66 | | mA |
| | | Sinking to V^+ $V_{\text{IN}} = -200\text{ mV}^{(6)}$ | 10.5 6.5 | 23 | | |
| I _S | Supply Current | LMP7711 Enable Mode $V_{\text{EN}} \geq 4.6$ | | 1.15 | 1.40 1.75 | mA |
| | | LMP7712 (per channel) Enable Mode $V_{\text{EN}} \geq 4.6$ | | 1.30 | 1.70 2.05 | |
| | | Shutdown Mode $V_{\text{EN}} \leq 0.4$ (per channel) | | 0.14 | 1 4 | μA |
| SR | Slew Rate | $A_V = +1$, Rising (10% to 90%) | 6.0 | 9.5 | | $\text{V}/\mu\text{s}$ |
| | | $A_V = +1$, Falling (90% to 10%) | 7.5 | 11.5 | | |
| GBW | Gain Bandwidth | | | 17 | | MHz |
| e _n | Input Referred Voltage Noise Density | $f = 400\text{ Hz}$ | | 7.0 | | $\text{nV}/\sqrt{\text{Hz}}$ |
| | | $f = 1\text{ kHz}$ | | 5.8 | | |
| i _n | Input Referred Current Noise Density | $f = 1\text{ kHz}$ | | 0.01 | | $\text{pA}/\sqrt{\text{Hz}}$ |
| t _{on} | Turn-on Time | | | 114 | | ns |
| t _{off} | Turn-off Time | | | 800 | | ns |
| V _{EN} | Enable Pin Voltage Range | Enable Mode | 4.6 | 4.5 – 5 | | V |
| | | Shutdown Mode | | 0 – 0.5 | 0.4 | |
| I _{EN} | Enable Pin Input Current | $V_{\text{EN}} = 5\text{V}^{(7)}$ | | 5.6 | 10 | μA |
| | | $V_{\text{EN}} = 0\text{V}^{(7)}$ | | 0.005 | 0.2 | |
| THD+N | Total Harmonic Distortion + Noise | $f = 1\text{ kHz}$, $A_V = 1$, $R_L = 100\text{ k}\Omega$ $V_O = 4\text{ V}_{\text{PP}}$ | | 0.001 | | % |
| | | $f = 1\text{ kHz}$, $A_V = 1$, $R_L = 600\Omega$ $V_O = 4\text{ V}_{\text{PP}}$ | | 0.004 | | |

(6) The short circuit test is a momentary open loop test.

(7) Positive current corresponds to current flowing into the device.

CONNECTION DIAGRAM

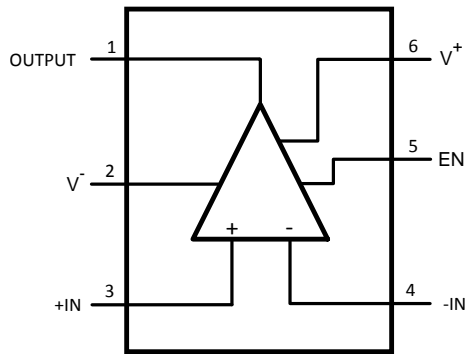

Figure 3. 6-Pin SOT - Top View
See Package Number DDC

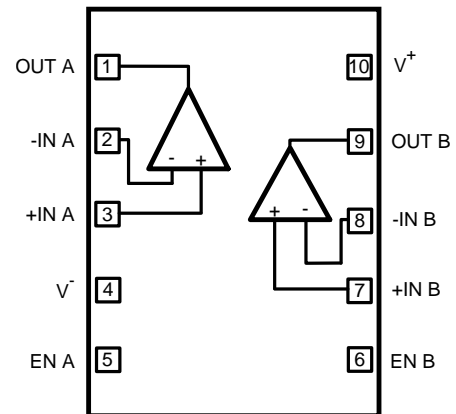

Figure 4. 10-Pin VSSOP-Top View
See Package Number DGS

TYPICAL PERFORMANCE CHARACTERISTICS

Unless otherwise noted: $T_A = 25^\circ\text{C}$, $V_S = 5\text{V}$, $V_{CM} = V_S/2$, $V_{EN} = V^+$.

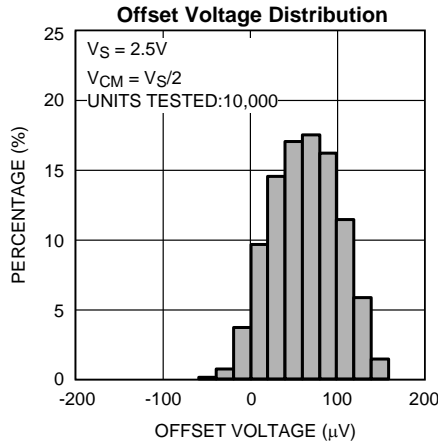

Figure 5.

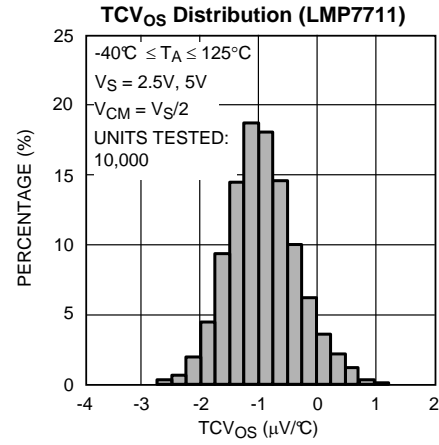

Figure 6.

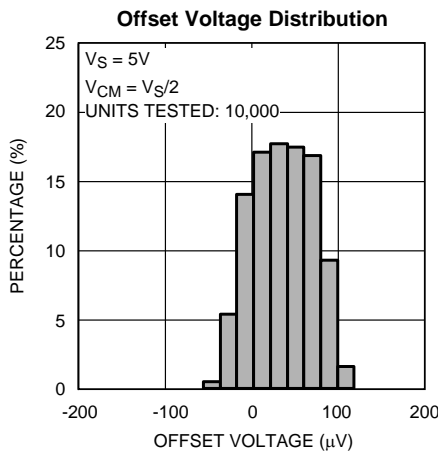

Figure 7.

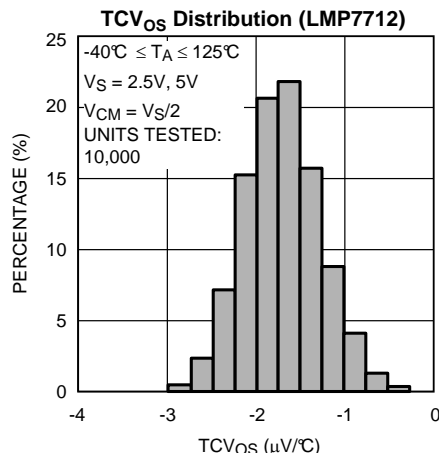

Figure 8.

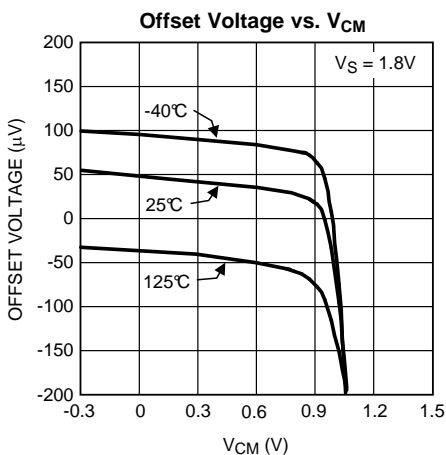

Figure 9.

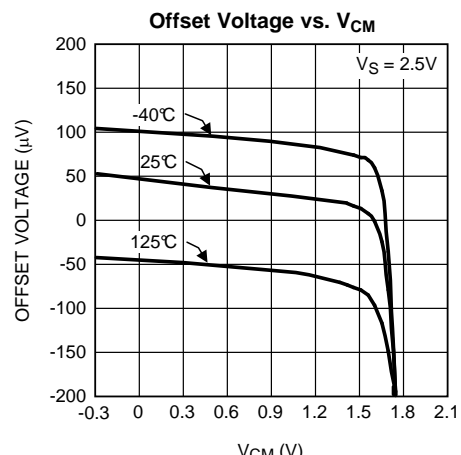

Figure 10.

TYPICAL PERFORMANCE CHARACTERISTICS (continued)

Unless otherwise noted: $T_A = 25^\circ\text{C}$, $V_S = 5\text{V}$, $V_{CM} = V_S/2$, $V_{EN} = V^+$.

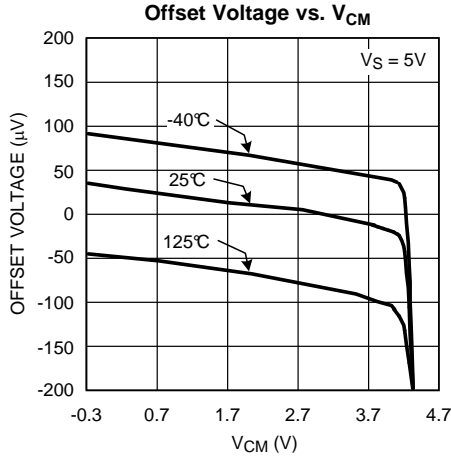

Figure 11.

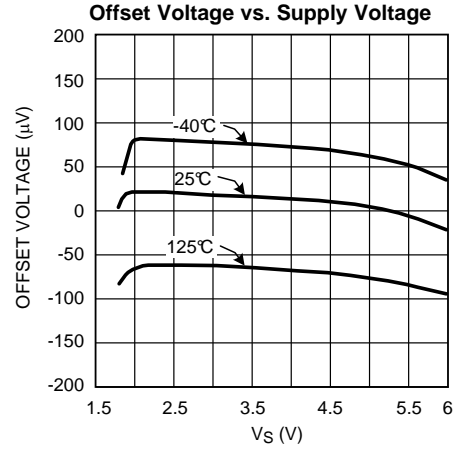

Figure 12.

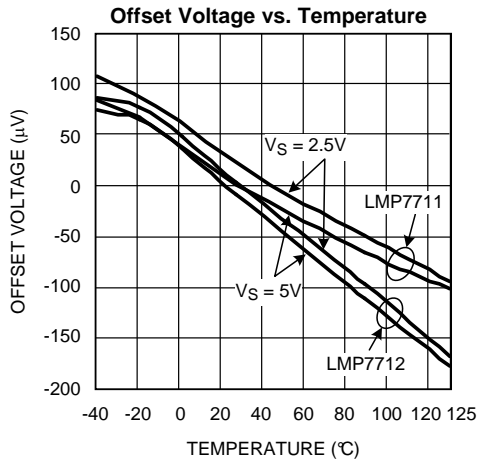

Figure 13.

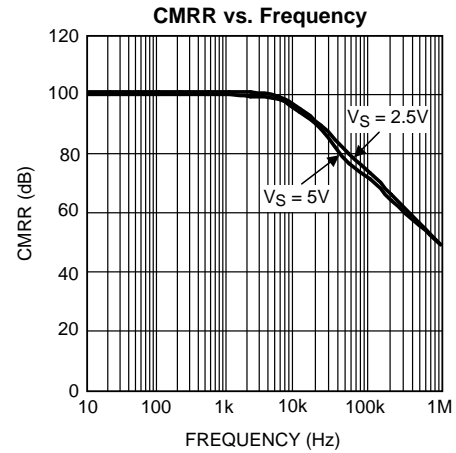

Figure 14.

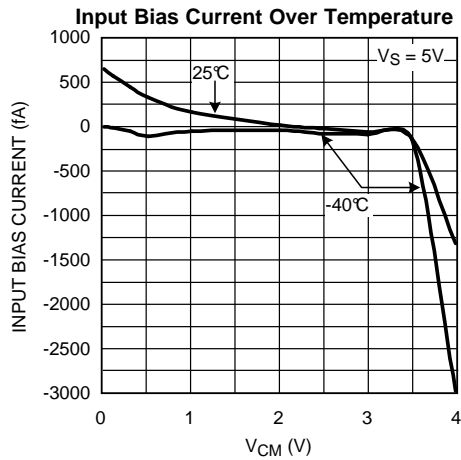

Figure 15.

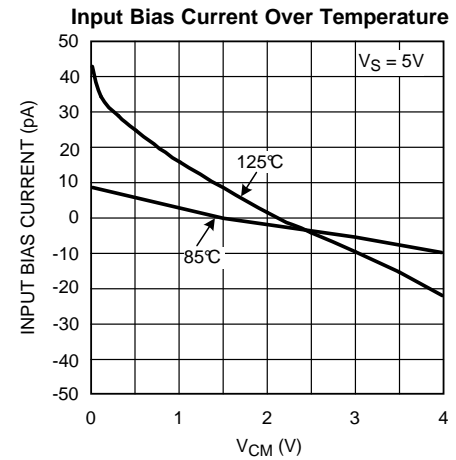

Figure 16.

TYPICAL PERFORMANCE CHARACTERISTICS (continued)

Unless otherwise noted: $T_A = 25^\circ\text{C}$, $V_S = 5\text{V}$, $V_{CM} = V_S/2$, $V_{EN} = V^+$.

Supply Current vs. Supply Voltage (LMP7711)

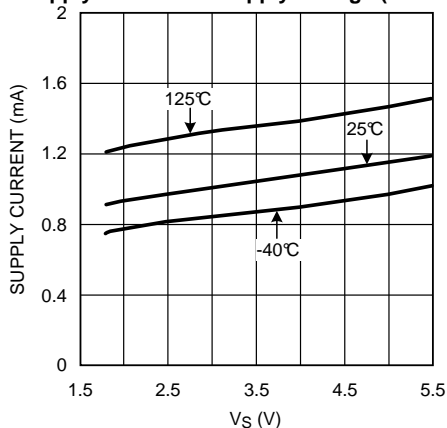

Figure 17.

Supply Current vs. Supply Voltage (LMP7712)

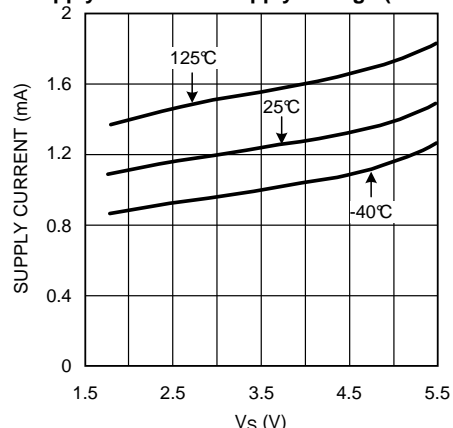

Figure 18.

Supply Current vs. Supply Voltage (Shutdown)

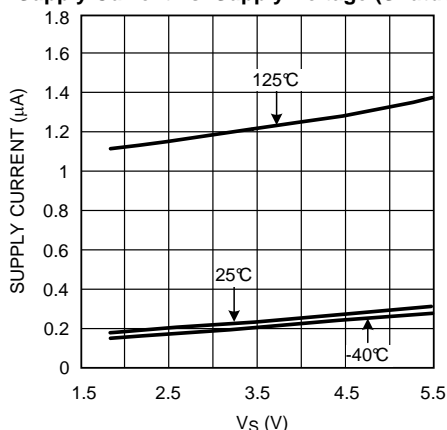

Figure 19.

Crosstalk Rejection Ratio (LMP7712)

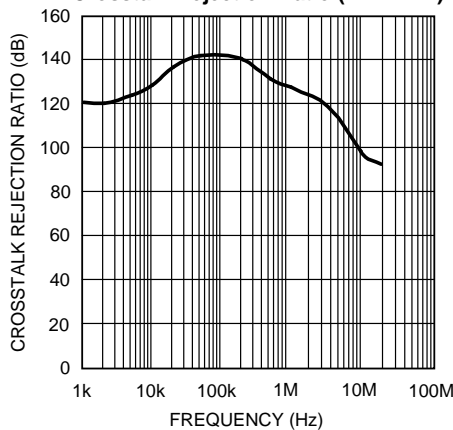

Figure 20.

Supply Current vs. Enable Pin Voltage (LMP7711)

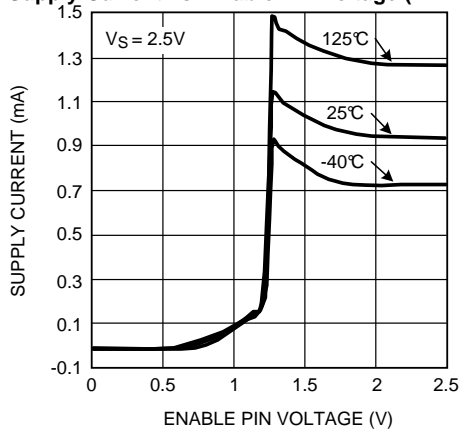

Figure 21.

Supply Current vs. Enable Pin Voltage (LMP7711)

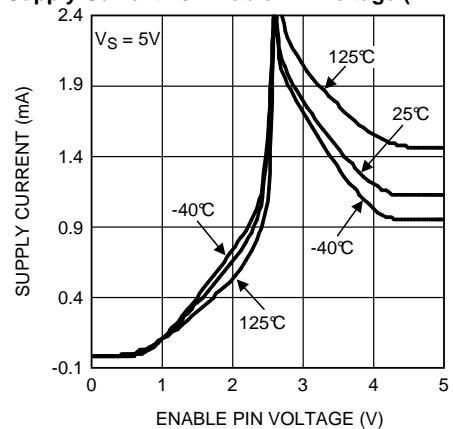

Figure 22.

TYPICAL PERFORMANCE CHARACTERISTICS (continued)

Unless otherwise noted: $T_A = 25^\circ\text{C}$, $V_S = 5\text{V}$, $V_{CM} = V_S/2$, $V_{EN} = V^+$.

Supply Current vs. Enable Pin Voltage (LMP7712)

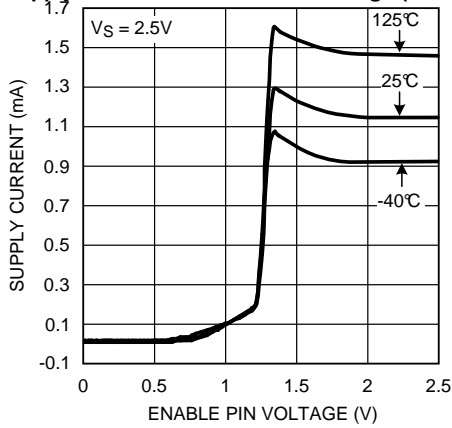

Figure 23.

Supply Current vs. Enable Pin Voltage (LMP7712)

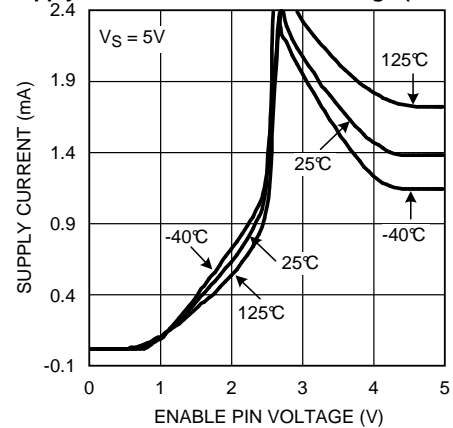

Figure 24.

Sourcing Current vs. Supply Voltage

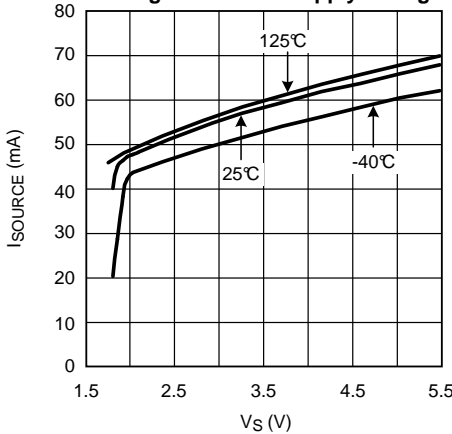

Figure 25.

Sinking Current vs. Supply Voltage

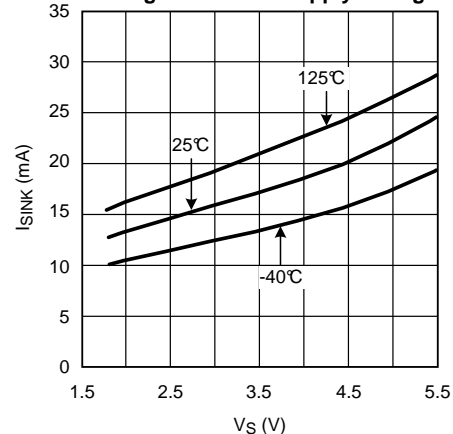

Figure 26.

Sourcing Current vs. Output Voltage

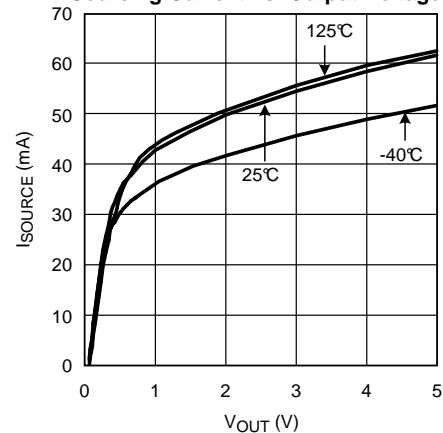

Figure 27.

Sinking Current vs. Output Voltage

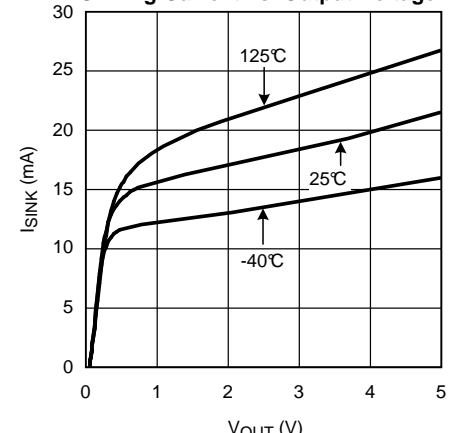

Figure 28.

TYPICAL PERFORMANCE CHARACTERISTICS (continued)

Unless otherwise noted: $T_A = 25^\circ\text{C}$, $V_S = 5\text{V}$, $V_{CM} = V_S/2$, $V_{EN} = V^+$.

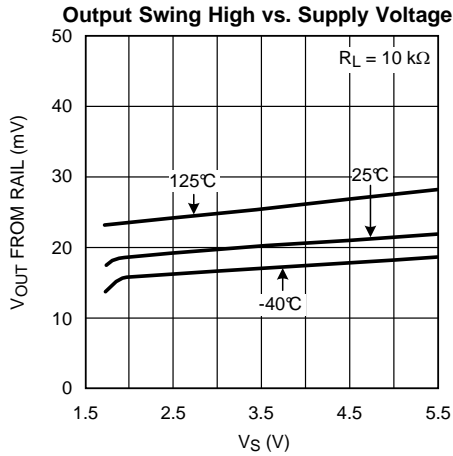

Figure 29.

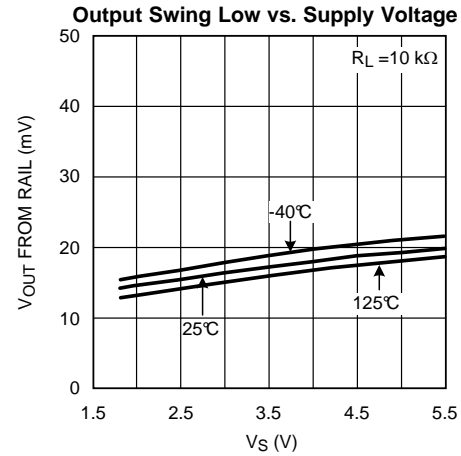

Figure 30.

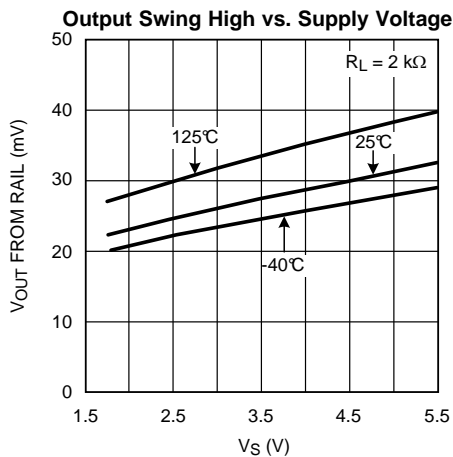

Figure 31.

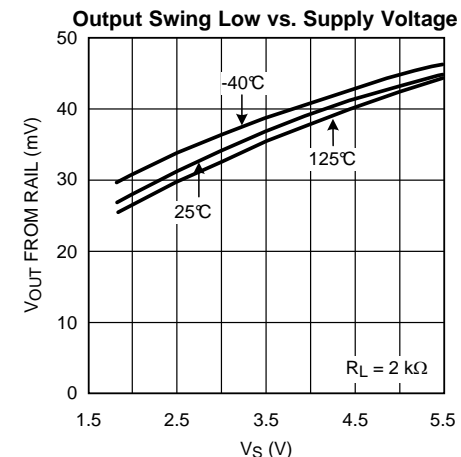

Figure 32.

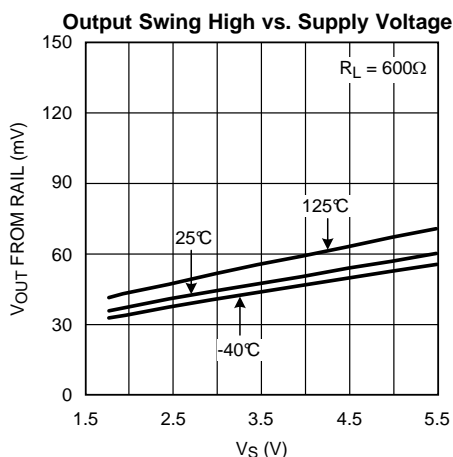

Figure 33.

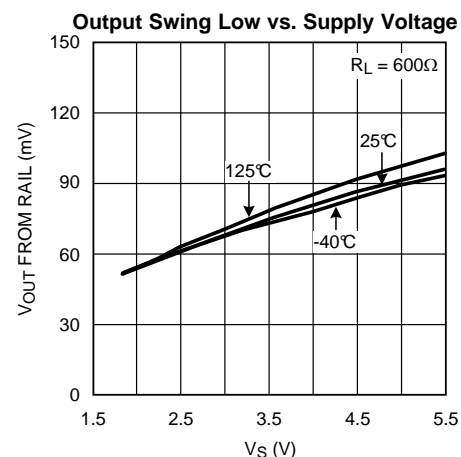

Figure 34.

TYPICAL PERFORMANCE CHARACTERISTICS (continued)

Unless otherwise noted: $T_A = 25^\circ\text{C}$, $V_S = 5\text{V}$, $V_{CM} = V_S/2$, $V_{EN} = V^+$.

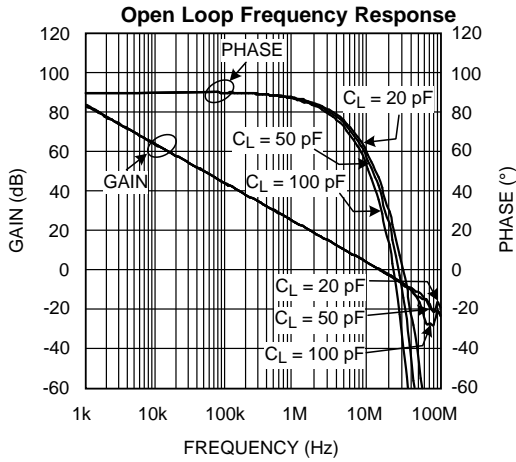

Figure 35.

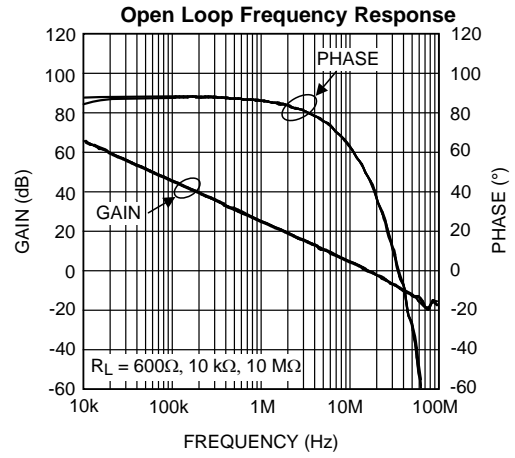

Figure 36.

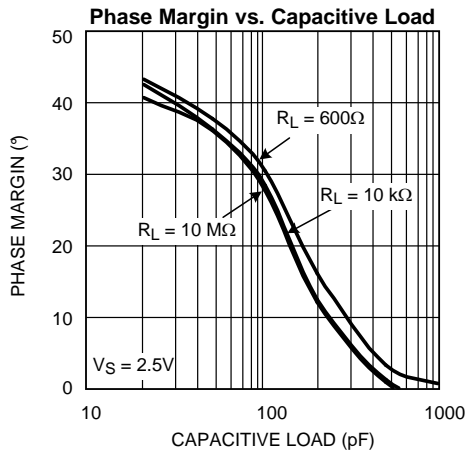

Figure 37.

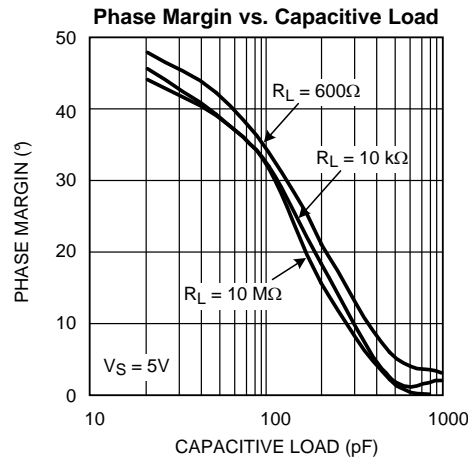

Figure 38.

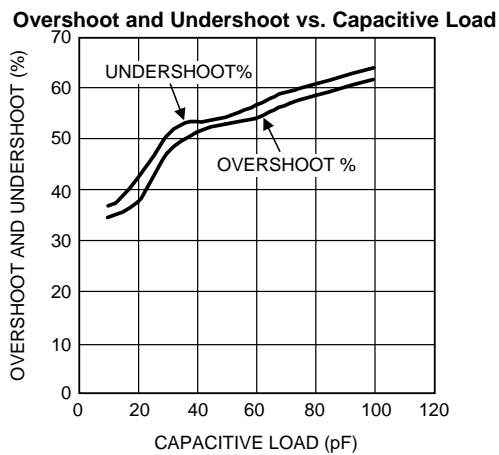

Figure 39.

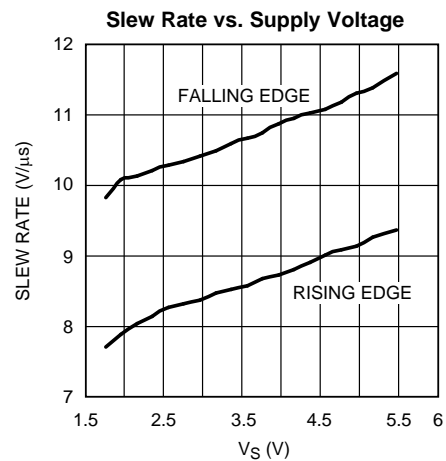

Figure 40.

TYPICAL PERFORMANCE CHARACTERISTICS (continued)

Unless otherwise noted: $T_A = 25^\circ\text{C}$, $V_S = 5\text{V}$, $V_{CM} = V_S/2$, $V_{EN} = V^+$.

Small Signal Step Response

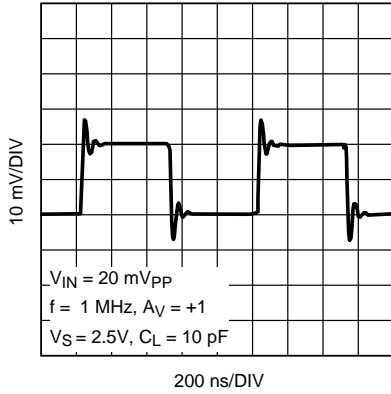

Figure 41.

Large Signal Step Response

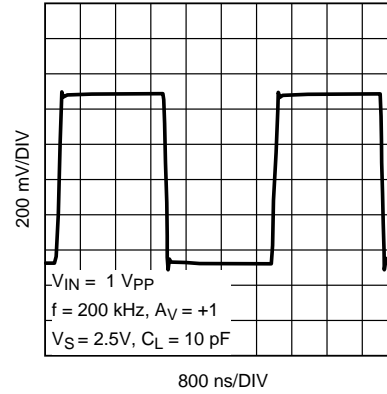

Figure 42.

Small Signal Step Response

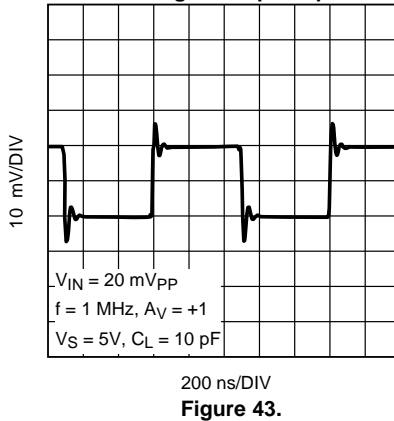

Figure 43.

Large Signal Step Response

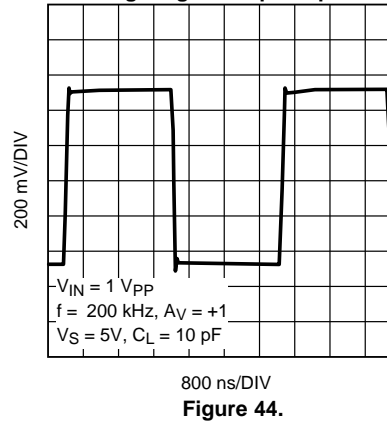

Figure 44.

THD+N vs. Output Voltage

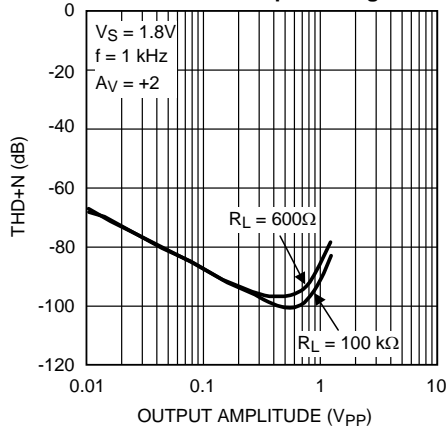

Figure 45.

THD+N vs. Output Voltage

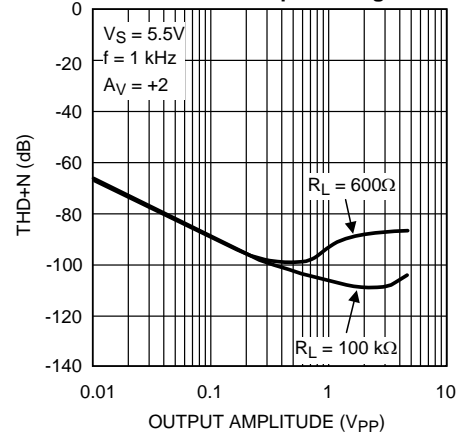

Figure 46.

TYPICAL PERFORMANCE CHARACTERISTICS (continued)

Unless otherwise noted: $T_A = 25^\circ\text{C}$, $V_S = 5\text{V}$, $V_{CM} = V_S/2$, $V_{EN} = V^+$.

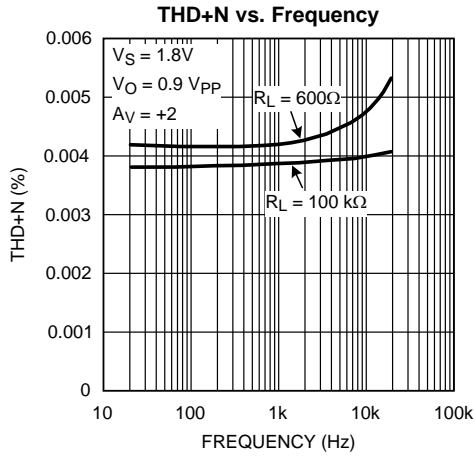

Figure 47.

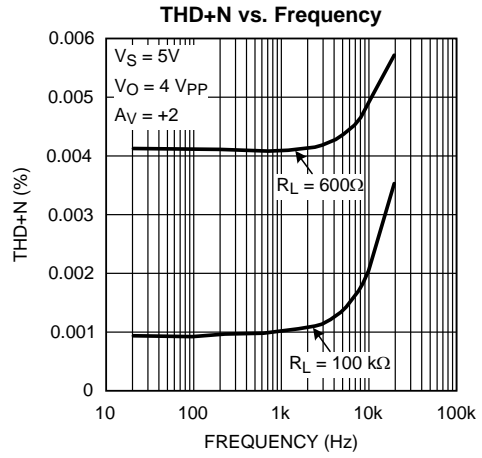

Figure 48.

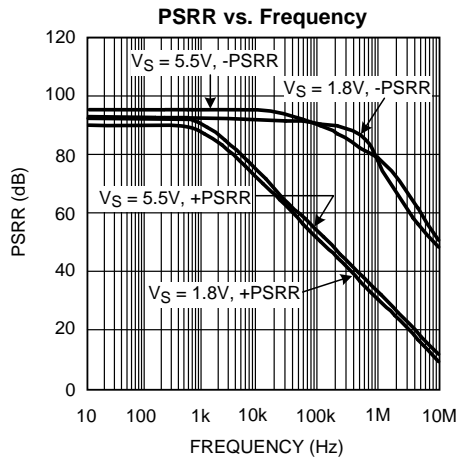

Figure 49.

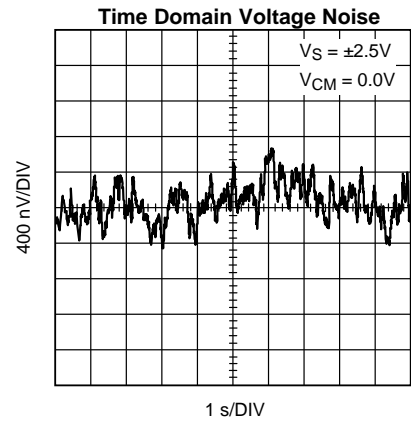

Figure 50.

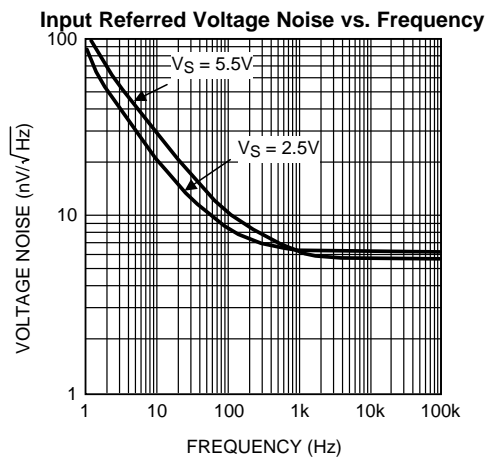

Figure 51.

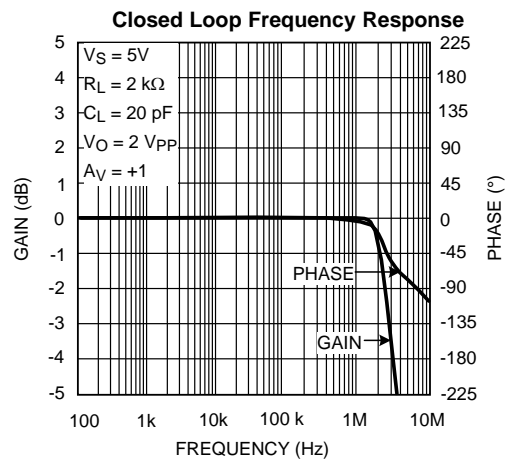

Figure 52.

TYPICAL PERFORMANCE CHARACTERISTICS (continued)

Unless otherwise noted: $T_A = 25^\circ\text{C}$, $V_S = 5\text{V}$, $V_{CM} = V_S/2$, $V_{EN} = V^+$.

Closed Loop Output Impedance vs. Frequency

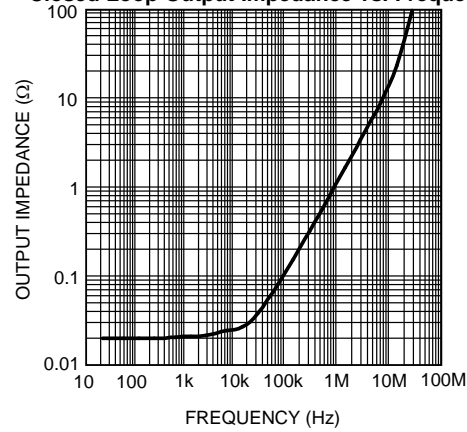

Figure 53.

APPLICATION NOTES

LMP7711/LMP7712

The LMP7711/LMP7712 are single and dual, low noise, low offset, rail-to-rail output precision amplifiers with a wide gain bandwidth product of 17 MHz and low supply current. The wide bandwidth makes the LMP7711/LMP7712 ideal choices for wide-band amplification in portable applications. The low supply current along with the enable feature that is built-in on the LMP7711/LMP7712 allows for even more power efficient designs by turning the device off when not in use.

The LMP7711/LMP7712 are superior for sensor applications. The very low input referred voltage noise of only 5.8 nV/√Hz at 1 kHz and very low input referred current noise of only 10 fA/√Hz mean more signal fidelity and higher signal-to-noise ratio.

The LMP7711/LMP7712 have a supply voltage range of 1.8V to 5.5V over a wide temperature range of 0°C to 125°C. This is optimal for low voltage commercial applications. For applications where the ambient temperature might be less than 0°C, the LMP7711/LMP7712 are fully operational at supply voltages of 2.0V to 5.5V over the temperature range of -40°C to 125°C.

The outputs of the LMP7711/LMP7712 swing within 25 mV of either rail providing maximum dynamic range in applications requiring low supply voltage. The input common mode range of the LMP7711/LMP7712 extends to 300 mV below ground. This feature enables users to utilize this device in single supply applications.

The use of a very innovative feedback topology has enhanced the current drive capability of the LMP7711/LMP7712, resulting in sourcing currents as much as 47 mA with a supply voltage of only 1.8V.

The LMP7711 is offered in the space saving SOT package and the LMP7712 is offered in a 10-pin VSSOP. These small packages are ideal solutions for applications requiring minimum PC board footprint.

Texas Instruments is heavily committed to precision amplifiers and the market segments they serves. Technical support and extensive characterization data is available for sensitive applications or applications with a constrained error budget.

CAPACITIVE LOAD

The unity gain follower is the most sensitive configuration to capacitive loading. The combination of a capacitive load placed directly on the output of an amplifier along with the output impedance of the amplifier creates a phase lag which in turn reduces the phase margin of the amplifier. If phase margin is significantly reduced, the response will be either underdamped or the amplifier will oscillate.

The LMP7711/LMP7712 can directly drive capacitive loads of up to 120 pF without oscillating. To drive heavier capacitive loads, an isolation resistor, R_{ISO} in [Figure 54](#), should be used. This resistor and C_L form a pole and hence delay the phase lag or increase the phase margin of the overall system. The larger the value of R_{ISO} , the more stable the output voltage will be. However, larger values of R_{ISO} result in reduced output swing and reduced output current drive.

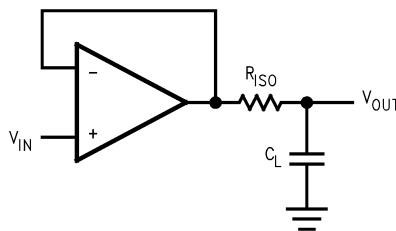

Figure 54. Isolating Capacitive Load

INPUT CAPACITANCE

CMOS input stages inherently have low input bias current and higher input referred voltage noise. The LMP7711/LMP7712 enhance this performance by having the low input bias current of only 50 fA, as well as, a very low input referred voltage noise of 5.8 nV/√Hz. In order to achieve this a larger input stage has been used. This larger input stage increases the input capacitance of the LMP7711/LMP7712. [Figure 55](#) shows typical input common mode input capacitance of the LMP7711/LMP7712.

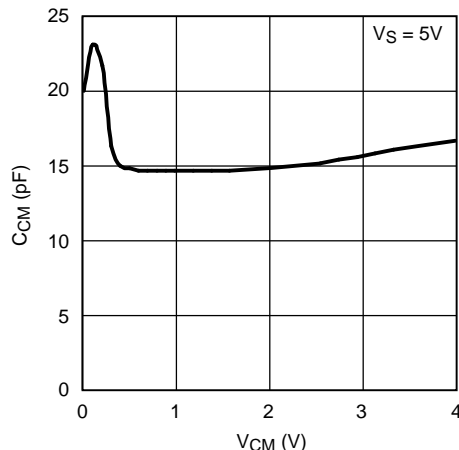

Figure 55. Input Common Mode Capacitance

This input capacitance will interact with other impedances such as gain and feedback resistors, which are seen on the inputs of the amplifier to form a pole. This pole will have little or no effect on the output of the amplifier at low frequencies and under DC conditions, but will play a bigger role as the frequency increases. At higher frequencies, the presence of this pole will decrease phase margin and also causes gain peaking. In order to compensate for the input capacitance, care must be taken in choosing feedback resistors. In addition to being selective in picking values for the feedback resistor, a capacitor can be added to the feedback path to increase stability.

The DC gain of the circuit shown in [Figure 56](#) is simply $-R_2/R_1$.

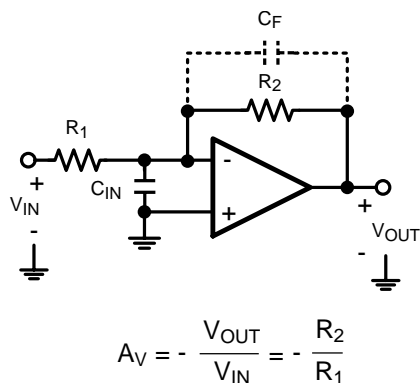

Figure 56. Compensating for Input Capacitance

For the time being, ignore C_F . The AC gain of the circuit in [Figure 56](#) can be calculated as follows:

$$\frac{V_{OUT}}{V_{IN}}(s) = \frac{-R_2/R_1}{1 + \frac{s}{\left(\frac{A_0 R_1}{R_1 + R_2}\right)} + \frac{s^2}{\left(\frac{A_0}{C_{IN} R_2}\right)}} \quad (1)$$

This equation is rearranged to find the location of the two poles:

$$P_{1,2} = \frac{-1}{2C_{IN}} \left[\frac{1}{R_1} + \frac{1}{R_2} \pm \sqrt{\left(\frac{1}{R_1} + \frac{1}{R_2}\right)^2 - \frac{4 A_0 C_{IN}}{R_2}} \right] \quad (2)$$

As shown in Equation 2, as the values of R_1 and R_2 are increased, the magnitude of the poles are reduced, which in turn decreases the bandwidth of the amplifier. Figure 57 shows the frequency response with different value resistors for R_1 and R_2 . Whenever possible, it is best to choose smaller feedback resistors.

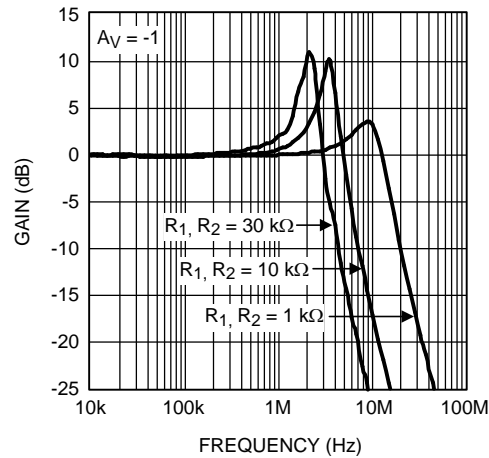

Figure 57. Closed Loop Frequency Response

As mentioned before, adding a capacitor to the feedback path will decrease the peaking. This is because C_F will form yet another pole in the system and will prevent pairs of poles, or complex conjugates from forming. It is the presence of pairs of poles that cause the peaking of gain. Figure 58 shows the frequency response of the schematic presented in Figure 56 with different values of C_F . As can be seen, using a small value capacitor significantly reduces or eliminates the peaking.

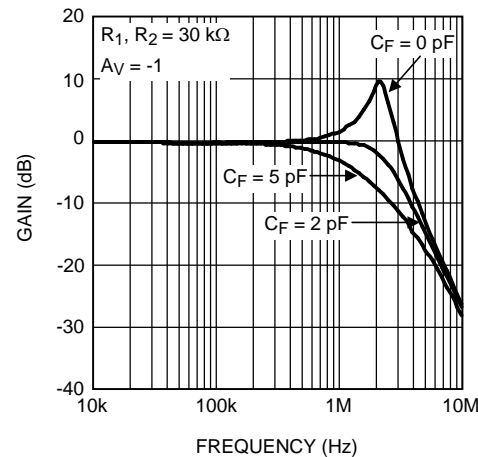

Figure 58. Closed Loop Frequency Response

TRANSIMPEDANCE AMPLIFIER

In many applications, the signal of interest is a very small amount of current that needs to be detected. Current that is transmitted through a photodiode is a good example. Barcode scanners, light meters, fiber optic receivers, and industrial sensors are some typical applications utilizing photodiodes for current detection. This current needs to be amplified before it can be further processed. This amplification is performed using a current-to-voltage converter configuration or transimpedance amplifier. The signal of interest is fed to the inverting input of an op amp with a feedback resistor in the current path. The voltage at the output of this amplifier will be equal to the negative of the input current times the value of the feedback resistor. Figure 59 shows a transimpedance amplifier configuration. C_D represents the photodiode parasitic capacitance and C_{CM} denotes the common-mode capacitance of the amplifier. The presence of all of these capacitances at higher frequencies might lead to less stable topologies at higher frequencies. Care must be taken when designing a transimpedance amplifier to prevent the circuit from oscillating.

With a wide gain bandwidth product, low input bias current and low input voltage and current noise, the LMP7711/LMP7712 are ideal for wideband transimpedance applications.

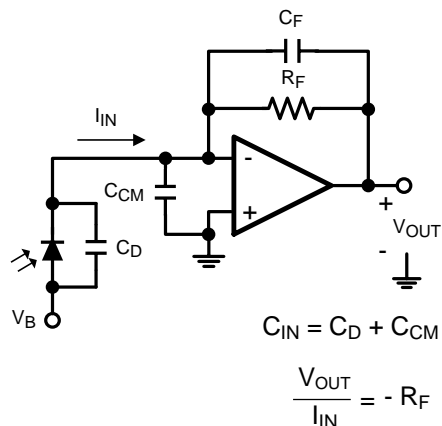

Figure 59. Transimpedance Amplifier

A feedback capacitance C_F is usually added in parallel with R_F to maintain circuit stability and to control the frequency response. To achieve a maximally flat, 2nd order response, R_F and C_F should be chosen by using Equation 3

$$C_F = \sqrt{\frac{C_{IN}}{GBWP * 2 \pi R_F}} \tag{3}$$

Calculating C_F from Equation 3 can sometimes result in capacitor values which are less than 2 pF. This is especially the case for high speed applications. In these instances, its often more practical to use the circuit shown in Figure 60 in order to allow more sensible choices for C_F . The new feedback capacitor, C'_F , is $(1 + R_B/R_A) C_F$. This relationship holds as long as $R_A \ll R_F$.

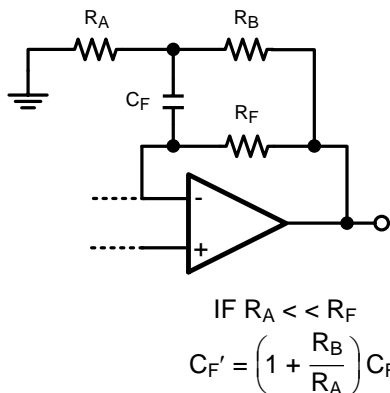

Figure 60. Modified Transimpedance Amplifier

SENSOR INTERFACE

The LMP7711/LMP7712 have low input bias current and low input referred noise, which make them ideal choices for sensor interfaces such as thermopiles, Infra Red (IR) thermometry, thermocouple amplifiers, and pH electrode buffers.

Thermopiles generate voltage in response to receiving radiation. These voltages are often only a few microvolts. As a result, the operational amplifier used for this application needs to have low offset voltage, low input voltage noise, and low input bias current. Figure 61 shows a thermopile application where the sensor detects radiation from a distance and generates a voltage that is proportional to the intensity of the radiation. The two resistors, R_A and R_B , are selected to provide high gain to amplify this signal, while C_F removes the high frequency noise.

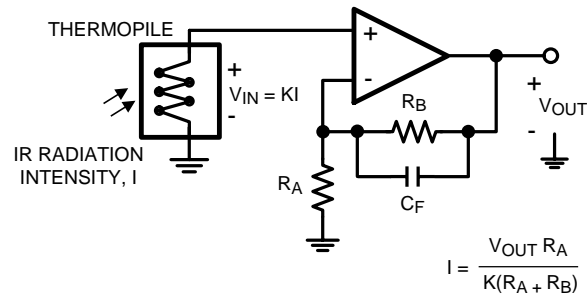

Figure 61. Thermopile Sensor Interface

PRECISION RECTIFIER

Rectifiers are electrical circuits used for converting AC signals to DC signals. Figure 62 shows a full-wave precision rectifier. Each operational amplifier used in this circuit has a diode on its output. This means for the diodes to conduct, the output of the amplifier needs to be positive with respect to ground. If V_{IN} is in its positive half cycle then only the output of the bottom amplifier will be positive. As a result, the diode on the output of the bottom amplifier will conduct and the signal will show at the output of the circuit. If V_{IN} is in its negative half cycle then the output of the top amplifier will be positive, resulting in the diode on the output of the top amplifier conducting and, delivering the signal on the amplifier's output to the circuit's output.

For $R_2/R_1 \geq 2$, the resistor values can be found by using the equation shown in Figure 62. If $R_2/R_1 = 1$, then R_3 should be left open, no resistor needed, and R_4 should simply be shorted.

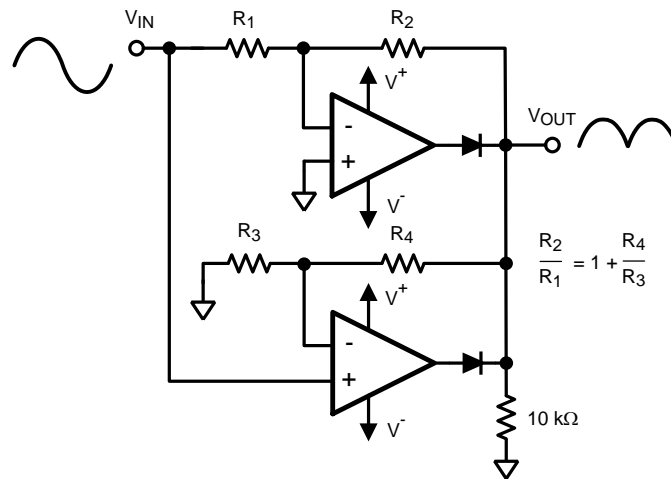

Figure 62. Precision Rectifier

REVISION HISTORY

| Changes from Revision E (May 2013) to Revision F | Page |
|--|--------------------|
| <hr/> <ul style="list-style-type: none">• Changed layout of National Data Sheet to TI format. | 20 |

PACKAGING INFORMATION

| Orderable Device | Status (1) | Package Type | Package Drawing | Pins | Package Qty | Eco Plan (2) | Lead finish/ Ball material (6) | MSL Peak Temp (3) | Op Temp (°C) | Device Marking (4/5) | Samples |
|------------------|---------------|--------------|-----------------|------|-------------|-----------------|--------------------------------------|----------------------|--------------|-------------------------|-------------------------|
| LMP7711MK/NOPB | ACTIVE | SOT-23-THIN | DDC | 6 | 1000 | RoHS & Green | SN | Level-1-260C-UNLIM | -40 to 125 | AC3A | Samples |
| LMP7711MKE/NOPB | ACTIVE | SOT-23-THIN | DDC | 6 | 250 | RoHS & Green | SN | Level-1-260C-UNLIM | -40 to 125 | AC3A | Samples |
| LMP7711MKX/NOPB | ACTIVE | SOT-23-THIN | DDC | 6 | 3000 | RoHS & Green | SN | Level-1-260C-UNLIM | -40 to 125 | AC3A | Samples |
| LMP7712MM/NOPB | ACTIVE | VSSOP | DGS | 10 | 1000 | RoHS & Green | SN | Level-1-260C-UNLIM | -40 to 125 | AD3A | Samples |
| LMP7712MME/NOPB | ACTIVE | VSSOP | DGS | 10 | 250 | RoHS & Green | SN | Level-1-260C-UNLIM | -40 to 125 | AD3A | Samples |

(1) The marketing status values are defined as follows:

ACTIVE: Product device recommended for new designs.

LIFEBUY: TI has announced that the device will be discontinued, and a lifetime-buy period is in effect.

NRND: Not recommended for new designs. Device is in production to support existing customers, but TI does not recommend using this part in a new design.

PREVIEW: Device has been announced but is not in production. Samples may or may not be available.

OBSELETE: TI has discontinued the production of the device.

(2) **RoHS:** TI defines "RoHS" to mean semiconductor products that are compliant with the current EU RoHS requirements for all 10 RoHS substances, including the requirement that RoHS substance do not exceed 0.1% by weight in homogeneous materials. Where designed to be soldered at high temperatures, "RoHS" products are suitable for use in specified lead-free processes. TI may reference these types of products as "Pb-Free".

RoHS Exempt: TI defines "RoHS Exempt" to mean products that contain lead but are compliant with EU RoHS pursuant to a specific EU RoHS exemption.

Green: TI defines "Green" to mean the content of Chlorine (Cl) and Bromine (Br) based flame retardants meet JS709B low halogen requirements of <=1000ppm threshold. Antimony trioxide based flame retardants must also meet the <=1000ppm threshold requirement.

(3) MSL, Peak Temp. - The Moisture Sensitivity Level rating according to the JEDEC industry standard classifications, and peak solder temperature.

(4) There may be additional marking, which relates to the logo, the lot trace code information, or the environmental category on the device.

(5) Multiple Device Markings will be inside parentheses. Only one Device Marking contained in parentheses and separated by a "~" will appear on a device. If a line is indented then it is a continuation of the previous line and the two combined represent the entire Device Marking for that device.

(6) Lead finish/Ball material - Orderable Devices may have multiple material finish options. Finish options are separated by a vertical ruled line. Lead finish/Ball material values may wrap to two lines if the finish value exceeds the maximum column width.

Important Information and Disclaimer: The information provided on this page represents TI's knowledge and belief as of the date that it is provided. TI bases its knowledge and belief on information provided by third parties, and makes no representation or warranty as to the accuracy of such information. Efforts are underway to better integrate information from third parties. TI has taken and continues to take reasonable steps to provide representative and accurate information but may not have conducted destructive testing or chemical analysis on incoming materials and chemicals. TI and TI suppliers consider certain information to be proprietary, and thus CAS numbers and other limited information may not be available for release.

In no event shall TI's liability arising out of such information exceed the total purchase price of the TI part(s) at issue in this document sold by TI to Customer on an annual basis.

TAPE AND REEL INFORMATION

QUADRANT ASSIGNMENTS FOR PIN 1 ORIENTATION IN TAPE

*All dimensions are nominal

| Device | Package Type | Package Drawing | Pins | SPQ | Reel Diameter (mm) | Reel Width W1 (mm) | A0 (mm) | B0 (mm) | K0 (mm) | P1 (mm) | W (mm) | Pin1 Quadrant |
|-----------------|--------------|-----------------|------|------|--------------------|--------------------|---------|---------|---------|---------|--------|---------------|
| LMP7711MK/NOPB | SOT-23-THIN | DDC | 6 | 1000 | 178.0 | 8.4 | 3.2 | 3.2 | 1.4 | 4.0 | 8.0 | Q3 |
| LMP7711MKE/NOPB | SOT-23-THIN | DDC | 6 | 250 | 178.0 | 8.4 | 3.2 | 3.2 | 1.4 | 4.0 | 8.0 | Q3 |
| LMP7711MKX/NOPB | SOT-23-THIN | DDC | 6 | 3000 | 178.0 | 8.4 | 3.2 | 3.2 | 1.4 | 4.0 | 8.0 | Q3 |
| LMP7712MM/NOPB | VSSOP | DGS | 10 | 1000 | 178.0 | 12.4 | 5.3 | 3.4 | 1.4 | 8.0 | 12.0 | Q1 |
| LMP7712MME/NOPB | VSSOP | DGS | 10 | 250 | 178.0 | 12.4 | 5.3 | 3.4 | 1.4 | 8.0 | 12.0 | Q1 |

TAPE AND REEL BOX DIMENSIONS

*All dimensions are nominal

| Device | Package Type | Package Drawing | Pins | SPQ | Length (mm) | Width (mm) | Height (mm) |
|-----------------|--------------|-----------------|------|------|-------------|------------|-------------|
| LMP7711MK/NOPB | SOT-23-THIN | DDC | 6 | 1000 | 208.0 | 191.0 | 35.0 |
| LMP7711MKE/NOPB | SOT-23-THIN | DDC | 6 | 250 | 208.0 | 191.0 | 35.0 |
| LMP7711MKX/NOPB | SOT-23-THIN | DDC | 6 | 3000 | 208.0 | 191.0 | 35.0 |
| LMP7712MM/NOPB | VSSOP | DGS | 10 | 1000 | 208.0 | 191.0 | 35.0 |
| LMP7712MME/NOPB | VSSOP | DGS | 10 | 250 | 208.0 | 191.0 | 35.0 |

IMPORTANT NOTICE AND DISCLAIMER

TI PROVIDES TECHNICAL AND RELIABILITY DATA (INCLUDING DATA SHEETS), DESIGN RESOURCES (INCLUDING REFERENCE DESIGNS), APPLICATION OR OTHER DESIGN ADVICE, WEB TOOLS, SAFETY INFORMATION, AND OTHER RESOURCES "AS IS" AND WITH ALL FAULTS, AND DISCLAIMS ALL WARRANTIES, EXPRESS AND IMPLIED, INCLUDING WITHOUT LIMITATION ANY IMPLIED WARRANTIES OF MERCHANTABILITY, FITNESS FOR A PARTICULAR PURPOSE OR NON-INFRINGEMENT OF THIRD PARTY INTELLECTUAL PROPERTY RIGHTS.

These resources are intended for skilled developers designing with TI products. You are solely responsible for (1) selecting the appropriate TI products for your application, (2) designing, validating and testing your application, and (3) ensuring your application meets applicable standards, and any other safety, security, regulatory or other requirements.

These resources are subject to change without notice. TI grants you permission to use these resources only for development of an application that uses the TI products described in the resource. Other reproduction and display of these resources is prohibited. No license is granted to any other TI intellectual property right or to any third party intellectual property right. TI disclaims responsibility for, and you will fully indemnify TI and its representatives against, any claims, damages, costs, losses, and liabilities arising out of your use of these resources.

TI's products are provided subject to [TI's Terms of Sale](#) or other applicable terms available either on ti.com or provided in conjunction with such TI products. TI's provision of these resources does not expand or otherwise alter TI's applicable warranties or warranty disclaimers for TI products.

TI objects to and rejects any additional or different terms you may have proposed.

Mailing Address: Texas Instruments, Post Office Box 655303, Dallas, Texas 75265
Copyright © 2021, Texas Instruments Incorporated