

Chip Multilayer Ceramic Capacitors for Automotive



2020

Contents

Product specifications are as of May 2020.

Explanation of Symbols in This Catalog	p3	
Selection Guide for Capacitors	p4	
Catalog Information	p5	
Part Numbering	p6	
Capacitance Table	p10	
Search Capacitors	p44	
		Cap. Table
<hr/>		
AEC-Q200 Compliant Chip Multilayer Ceramic Capacitors for Infotainment GRT Series	p45	p11
<hr/>		
Chip Multilayer Ceramic Capacitors for Automotive GCM Series	p57	p20
<hr/>		
High Effective Capacitance & High Ripple Current Chip Multilayer Ceramic Capacitors for Automotive GC3 Series	p90	p31
<hr/>		
Soft Termination Chip Multilayer Ceramic Capacitors for Automotive GCJ Series	p92	p32
<hr/>		
High Q Chip Multilayer Ceramic Capacitors for Automotive GCQ Series	p99	p36
<hr/>		
MLSC Design Chip Multilayer Ceramic Capacitors for Automotive GCD Series	p106	p36
<hr/>		
Soft Termination MLSC Design Chip Multilayer Ceramic Capacitors for Automotive GCE Series	p109	p37
<hr/>		
Very Large Current 3 Terminals Low ESL Chip Multilayer Ceramic Capacitors for Automotive NFM Series	p112	p37
<hr/>		
Metal Terminal Type Multilayer Ceramic Capacitors for Automotive KCM Series	p115	p37
<hr/>		
High Effective Capacitance & High Allowable Ripple Current Metal Terminal Type Multilayer Ceramic Capacitors for Automotive KC3 Series	p119	p38
<hr/>		
Safety Standard Certified Metal Terminal Type Multilayer Ceramic Capacitors for Automotive KCA Series	p122	p38
<hr/>		
Ni Plating + Pd Plating Termination Conductive Glue Mounting Chip Multilayer Ceramic Capacitors for Automotive GCB Series	p125	p38
<hr/>		
AgPd Termination Conductive Glue Mounting Chip Multilayer Ceramic Capacitors for Automotive GCG Series	p127	p39
<hr/>		
⚠Caution/Notice	p147	
Web page SimSurfing	p168	
Introduction	p169	

Please check the MURATA website (<https://www.murata.com/>)
 if you cannot find a part number in this catalog.

EU RoHS Compliant

- All the products in this catalog comply with EU RoHS.
- EU RoHS is "the European Directive 2011/65/EU on the Restriction of the Use of Certain Hazardous Substances in Electrical and Electronic Equipment."
- For more details, please refer to our web page, "Murata's Approach for EU RoHS" (<https://www.murata.com/en-eu/support/compliance/rohs>).

GRT Series
GCM Series
GC3 Series
GCJ Series
GCQ Series
GCD Series
GCE Series
NFM Series
KCM Series
KC3 Series
KCA Series
GCB Series
GCG Series
⚠Caution/Notice

Explanation of Symbols in This Catalog



Links are provided to the latest information from the PDF version of the catalog, which is available on the web.

General	For applications that do not require the particular reliability such as the general equipment
Info-tainment	Infotainment for Automotive The product for entertainment equipment like car navigations, car audios, and body control equipment like wipers, power windows.
Powertrain	Powertrain/Safety for Automotive Product used for applications (running, turning, stopping and safety devices) which particularly concern human life, such as in devices for automobiles.
Medical Device	Medical-grade products for Implanted Medical Devices These products are intended for use in implanted medical devices such as cardiac pacemakers, cochlear implants, insulin pumps and gastric electrostimulators. They are suitable for use in non-critical circuits. *1 *1 Non-critical circuits This term refers to circuits in implanted medical devices that are not directly linked to life support, i.e. circuits that will not directly endanger the life of the patient should the functionality of the device be reduced or halted by failure of the circuit.
AEC-Q200	AEC-Q200 compliant product
Safety standard	Safety Standard Certified Product Products that acquired safety standard certification IEC60384-14 and products based on the Electrical Appliance and Material Safety Law of Japan.
Japanese Safety Law	Based on the Electrical Appliance and Material Safety Law of Japan Products that are based on the electrical appliance and material safety law of Japan.
High Q	Low dissipation for high frequency By devising ceramic materials and electrode materials, low dissipation is achieved in frequency bands of VHF, UHF and microwave or beyond.
Low ESL	Low inductance This capacitor is designed so that the parasitic inductance component (ESL) that the capacitor has on the high frequency side becomes lower.
Deflecting crack	Product resistant to deflection cracking This capacitor is designed to prevent failures as much as possible by short mode caused by cracking when there is board deflection.
Soldering crack	Product with solder cracking suppression "This capacitor is configured with metal terminals and leads connected to the chip. The metal terminals and leads relieve the stress from expansion and contraction of the solder, to suppress solder cracking."
Anti-noise	Product suitable for acoustic noise reduction and low distortion This product suppresses acoustic noise, which occurs when a ceramic capacitor is used, by devising the materials and configuration.
Effective Cap	No DC bias characteristics Polymer capacitor is no capacitance change with DC bias due to aluminum oxidized film for dielectric.
EMI Filter	Low-inductance product suitable for noise suppression. This product has extremely low ESL and is suitable for suppression of noise, including high frequencies. This product can also be used as a low-ESL, high-performance bypass capacitor.
Bonding	Product for bonding Since gold is used for the external electrodes, the capacitor can be mounted by die bonding/wire bonding.

D1 Derating 1	<p>Derating 1 Murata's General MLCC products are designed for use in devices with a typical lifetime around 10 years. Murata's general MLCC products are designed so that the useful lifetime can be extended longer than 10 years under the following conditions: "80% of the rated voltage or less, Maximum operating temperature -20 degree C or less" Extended useful lifetime, under specific operating conditions, can be estimated from the chart. • The useful lifetime is the time when cumulative failure rate becomes 1%. • Please note that the useful lifetime data is for reference only and not guaranteed.</p> <p>at rated voltage x 80%</p>
D2 Derating 2	<p>Derating 2 When the product temperature exceeds 105°C, please use this product within the voltage and temperature derated conditions in the figure below.</p>
D3 Derating 3	<p>Derating 3 Please apply the derating curve according to the operating temperature. Please refer to detailed specifications sheet for details.</p>
D4 Derating 4	<p>Derating 4 When the product temperature exceeds 125°C, please use this product within the voltage and temperature derated conditions in the figure below.</p>
D5 Derating 5	<p>Derating 5 Please apply the rated voltage derating over 150 °C. Please refer to detailed specifications sheet for details.</p>

Catalog Information

Catalog relates to a multilayer ceramic capacitor is below.

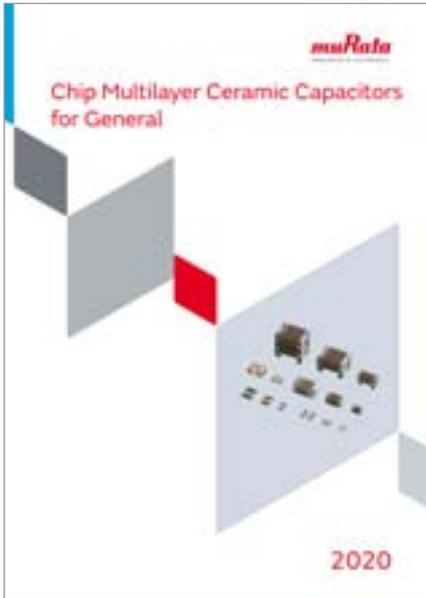

Chip Multilayer Ceramic Capacitors for General

Cat No. C02E-22

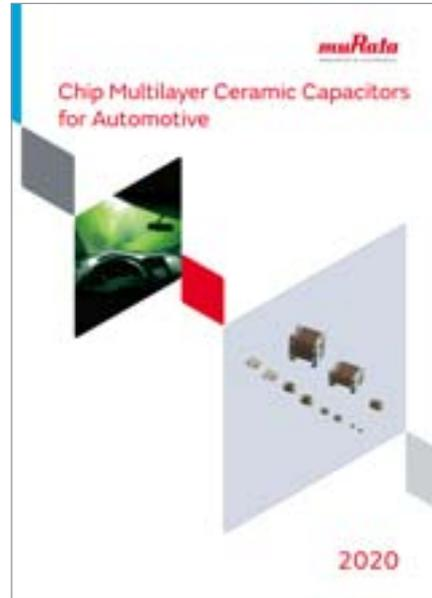

Chip Multilayer Ceramic Capacitors for Automotive

Cat No. C03E-11

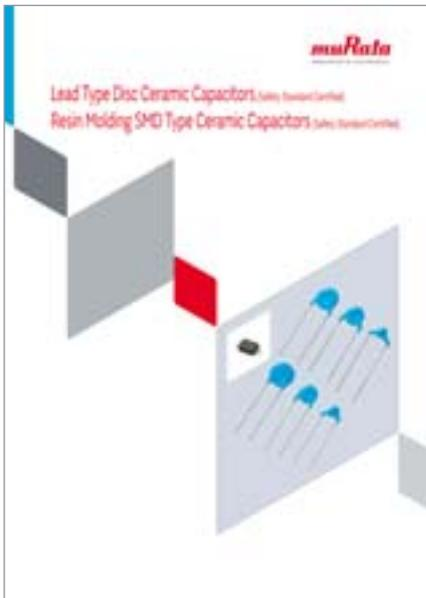

**Lead Type Disc Ceramic Capacitors (Safety Standard Certified)
Resin Molding SMD Type Ceramic Capacitors (Safety Standard Certified)**

Cat No. C85E-7

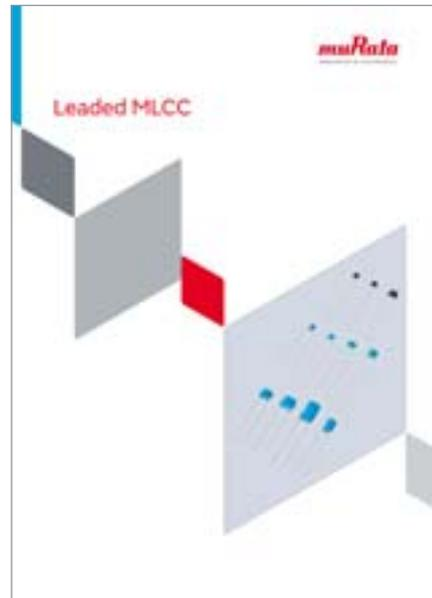

Leaded MLCC

Cat No. C49E-25

● Part Numbering

Chip Multilayer Ceramic Capacitors for Automotive



(Part Number)

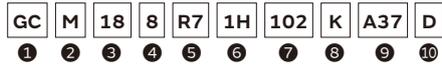

① Product ID ② Series

Product ID	Code	Series
GC	3	High Effective Capacitance & High Ripple Current Chip Multilayer Ceramic Capacitors for Automotive
	B	Ni Plating + Pd Plating termination Conductive Glue Mounting Chip Multilayer Ceramic Capacitors for Automotive
	D	MLSC Design Chip Multilayer Ceramic Capacitors for Automotive
	E	Soft Termination MLSC Design Chip Multilayer Ceramic Capacitors for Automotive
	G	AgPd Termination Conductive Glue Mounting Chip Multilayer Ceramic Capacitors for Automotive
	J	Soft Termination Chip Multilayer Ceramic Capacitors for Automotive
	M	Chip Multilayer Ceramic Capacitors for Automotive
	Q	High Q Chip Multilayer Ceramic Capacitors for Automotive
GR	T	AEC-Q200 Compliant Chip Multilayer Ceramic Capacitors for Infotainment
KC	3	High Effective Capacitance & High Allowable Ripple Current Metal Terminal Type Multilayer Ceramic Capacitors for Automotive
	A	Safety Standard Certified Metal Terminal Type Multilayer Ceramic Capacitors for Automotive
	M	Metal Terminal Type Multilayer Ceramic Capacitors for Automotive

③ Chip Dimension (L x W)

Code	Dimension (L x W)	EIA
03	0.6 x 0.3mm	0201
15	1.0 x 0.5mm	0402
18	1.6 x 0.8mm	0603
21	2.0 x 1.25mm	0805
31	3.2 x 1.6mm	1206
32	3.2 x 2.5mm	1210
43	4.5 x 3.2mm	1812
55	5.7 x 5.0mm	2220

④ Height Dimension (T) (Except KC□)

Code	Dimension (T)
2	0.2mm
3	0.3mm
5	0.5mm
6	0.6mm
8	0.8mm
9	0.85mm
A	1.0mm
B	1.25mm
C	1.6mm
D	2.0mm
E	2.5mm
M	1.15mm
N	1.35mm
Q	1.5mm
X	Depends on individual standards.

④ Height Dimension (T) (KC□ Only)

Code	Dimension (T)
L	2.8mm
R	3.6mm
Q	3.7mm
T	4.8mm
V	6.2mm
W	6.4mm

Continued on the following page. ↗

(Part Number)

GC	M	18	8	R7	1H	102	K	A37	D
1	2	3	4	5	6	7	8	9	10

Continued from the preceding page. ↘

⑤ Temperature Characteristics

Temperature Characteristic Codes			Temperature Characteristics			Operating Temperature Range	Capacitance Change Each Temperature (%)						
Code	Public STD Code	Reference Temperature	Temperature Range	Capacitance Change or Temperature Coefficient	-55°C		*3		-10°C				
					Max.		Min.	Max.	Min.	Max.	Min.		
0C	CHA	*1	20°C	20 to 150°C	0±60ppm/°C	-55 to 150°C		0.82	-0.45	0.49	-0.27	0.33	-0.18
2C	CH	JIS	20°C	20 to 125°C	0±60ppm/°C	-55 to 125°C		0.82	-0.45	0.49	-0.27	0.33	-0.18
3C	CJ	JIS	20°C	20 to 125°C	0±120ppm/°C	-55 to 125°C		1.37	-0.9	0.82	-0.54	0.55	-0.36
4C	CK	JIS	20°C	20 to 125°C	0±250ppm/°C	-55 to 125°C		2.56	-1.88	1.54	-1.13	1.02	-0.75
5C	C0G	EIA	25°C	25 to 125°C	0±30ppm/°C	-55 to 125°C		0.58	-0.24	0.4	-0.17	0.25	-0.11
5G	X8G	*1	25°C	25 to 150°C	0±30ppm/°C	-55 to 150°C		0.58	-0.24	0.4	-0.17	0.25	-0.11
7U	U2J	EIA	25°C	25 to 125°C *2	-750±120ppm/°C	-55 to 125°C		8.78	5.04	6.04	3.47	3.84	2.21
9E	ZLM	*1	20°C	-55 to -40°C	-4700+1000/-2500ppm/°C	-55 to 125°C	-	-	-	-	-	-	
				-40 to 20°C	-5350±750ppm/°C		-	-	-	-	-	-	
				20 to 85°C	-4700±500ppm/°C		-	-	-	-	-	-	
				85 to 125°C	-4700+2000/-1000ppm/°C		-	-	-	-	-	-	
C7	X7S	EIA	25°C	-55 to 125°C	±22%	-55 to 125°C		-	-	-	-	-	-
C8	X6S	EIA	25°C	-55 to 105°C	±22%	-55 to 105°C		-	-	-	-	-	-
D7	X7T	EIA	25°C	-55 to 125°C	+22%, -33%	-55 to 125°C		-	-	-	-	-	-
L8	X8L	*1	25°C	-55 to 150°C	+15%, -40%	-55 to 150°C		-	-	-	-	-	-
M8	X8M	*1	25°C	-55 to 150°C	+15%, -50%	-55 to 150°C		-	-	-	-	-	-
R6	X5R	EIA	25°C	-55 to 85°C	±15%	-55 to 85°C		-	-	-	-	-	-
R7	X7R	EIA	25°C	-55 to 125°C	±15%	-55 to 125°C		-	-	-	-	-	-
R9	X8R	EIA	25°C	-55 to 150°C	±15%	-55 to 150°C		-	-	-	-	-	-

*1 Murata Temperature Characteristic Code.

*2 Rated Voltage 100Vdc max: 25 to 85°C

*3 -25°C (Reference Temperature 20°C) / -30°C (Reference Temperature 25°C)

⑥ Rated Voltage

Code		Rated Voltage
Standard Product	Voltage Derated Product	
0E	-	DC2.5V
0G	-	DC4V
0J	EC	DC6.3V
1A	ED	DC10V
1C	EE	DC16V
1E	EF	DC25V
YA	EG	DC35V
1H	EH	DC50V
1J	-	DC63V
1K	-	DC80V
2A	EL	DC100V
2E	-	DC250V
2W	LP	DC450V
2J	LQ	DC630V
3A	-	DC1kV
MF	-	X1/Y2: AC250V (Safety Standard Certified Type MF)

⑦ Capacitance

Expressed by three-digit alphanumerics. The unit is pico-farad (pF). The first and second figures are significant digits, and the third figure expresses the number of zeros that follow the two numbers.

If there is a decimal point, it is expressed by the capital letter "R." In this case, all figures are significant digits.

If any letter, other than "R" is included, this indicates the specific part number is a non-standard part.

Ex.)

Code	Capacitance
R50	0.50pF
1R0	1.0pF
100	10pF
103	10000pF

Continued on the following page. ↗

(Part Number)

GC	M	18	8	R7	1H	102	K	A37	D
1	2	3	4	5	6	7	8	9	10

Continued from the preceding page. ↘

③ Capacitance Tolerance

Code	Capacitance Tolerance
B	±0.1pF
C	±0.25pF
D	±0.5pF
F	±1%
G	±2%
J	±5%
K	±10%
M	±20%
R	Depends on individual standards.
W	±0.05pF

⑨ Individual Specification Code

Expressed by three figures.

⑩ Package

Code	Package
L	ø180mm Embossed Taping
D/W	ø180mm Paper Taping
K	ø330mm Embossed Taping
J	ø330mm Paper Taping

Please contact us if you find any part number not provided in this table.

3 Terminal Low ESL Multilayer Ceramic Capacitors



(Part Number)

NF	M	3D	CC	102	R	1H	3	L
1	2	3	4	5	6	7	8	9

1 Product ID 2 Series

Product ID	Series
NFM	3 Terminal Low ESL Type

3 Dimensions (LxW)

Code	Dimensions (LxW)	EIA
18	1.6x0.8mm	0603
21	2.0x1.25mm	0805
31	3.2x1.6mm	1206

4 Features

Code	Features	
HC	Powertrain/Safety for Automotive	For Signal Lines / For Large Current
HK		For Very Large Current

5 Capacitance

Expressed by three figures. The unit is in pico-farad (pF). The first and second figures are significant digits, and the third figure expresses the number of zeros that follow the two figures.

6 Characteristics

Code	Capacitance Temperature Characteristics
C	±22%
R	±15%, +15/-18%

7 Rated Voltage

Code	Rated Voltage
0J	6.3V
1A	10V
1C	16V
1H	50V
2A	100V

8 Electrode

Code	Electrode
3	Sn Plating

9 Packaging

Code	Packaging
L	Embossed Taping (ø180mm Reel)
D	Paper Taping (ø180mm Reel)

Please contact us if you find any part number not provided in this table.

Capacitance Table

How to read the Capacitance Table

L×W (mm)	0.6×0.3			1.0×0.5	
T max. (mm)	0.33			0.5	
Rated Voltage (Vdc)	100	50	25	100	50
Cap. / TC Code	COG	COG	COG	COG	COG
0.10pF	p46	p47	p48		
0.11pF			p48		p50
0.12pF					p50
0.13pF			p48		p50
0.15pF			p48		p50

The values can be narrowed down in the order of size, rated voltage, and temperature characteristics.

Refers to the page of the part number list.
 Check the part number list for the applicable product number.

Temperature Characteristics Table

The Table is colored by temperature characteristic codes. Refer to the following Table for the meaning of each code.

Temperature Characteristic Codes		Temperature Characteristics			Operating Temperature Range	Capacitance Change Each Temperature (%)					
Public STD Code	Reference Temperature	Temperature Range	Capacitance Change or Temperature Coefficient	-55°C		*3		-10°C			
				Max.		Min.	Max.	Min.	Max.	Min.	
CHA	*1	20°C	20 to 150°C	0±60ppm/°C	-55 to 150°C	0.82	-0.45	0.49	-0.27	0.33	-0.18
CH	JIS	20°C	20 to 125°C	0±60ppm/°C	-55 to 125°C	0.82	-0.45	0.49	-0.27	0.33	-0.18
CJ	JIS	20°C	20 to 125°C	0±120ppm/°C	-55 to 125°C	1.37	-0.9	0.82	-0.54	0.55	-0.36
CK	JIS	20°C	20 to 125°C	0±250ppm/°C	-55 to 125°C	2.56	-1.88	1.54	-1.13	1.02	-0.75
COG	EIA	25°C	25 to 125°C	0±30ppm/°C	-55 to 125°C	0.58	-0.24	0.4	-0.17	0.25	-0.11
X8G	*1	25°C	25 to 150°C	0±30ppm/°C	-55 to 150°C	0.58	-0.24	0.4	-0.17	0.25	-0.11
U2J	EIA	25°C	25 to 125°C *2	-750±120ppm/°C	-55 to 125°C	8.78	5.04	6.04	3.47	3.84	2.21
ZLM	*1	20°C	-55 to -40°C	-4700+1000/-2500ppm/°C	-55 to 125°C	-	-	-	-	-	-
			-40 to 20°C	-5350±750ppm/°C		-	-	-	-	-	-
			20 to 85°C	-4700±500ppm/°C		-	-	-	-	-	-
			85 to 125°C	-4700+2000/-1000ppm/°C		-	-	-	-	-	-
X7S	EIA	25°C	-55 to 125°C	±22%	-55 to 125°C	-	-	-	-	-	-
X6S	EIA	25°C	-55 to 105°C	±22%	-55 to 105°C	-	-	-	-	-	-
X7T	EIA	25°C	-55 to 125°C	+22%, -33%	-55 to 125°C	-	-	-	-	-	-
X8L	*1	25°C	-55 to 150°C	+15%, -40%	-55 to 150°C	-	-	-	-	-	-
X8M	*1	25°C	-55 to 150°C	+15%, -50%	-55 to 150°C	-	-	-	-	-	-
X5R	EIA	25°C	-55 to 85°C	±15%	-55 to 85°C	-	-	-	-	-	-
X7R	EIA	25°C	-55 to 125°C	±15%	-55 to 125°C	-	-	-	-	-	-
X8R	EIA	25°C	-55 to 150°C	±15%	-55 to 150°C	-	-	-	-	-	-

*1 Murata Temperature Characteristic Code.

*2 Rated Voltage 100Vdc max: 25 to 85°C

*3 -25°C (Reference Temperature 20°C) / -30°C (Reference Temperature 25°C)

Capacitance Table

GRT Series Temperature Compensating Type

p00 ← Part Number List EIA: COG

L×W (mm)	0.6×0.3			1.0×0.5			1.6×0.8			2.0×1.25			3.2×1.6				
T max. (mm)	0.33			0.55			0.9			0.6	0.7	1.35	0.95	1.8			
Rated Voltage (Vdc)	100	50	25	100	50	25	100	50	25	25	100	50	100	100	50	25	16
Cap. / TC Code	COG	COG	COG	COG	COG	COG	COG	COG	COG	COG	COG	COG	COG	COG	COG	COG	COG
0.10pF	p46	p47	p48														
0.11pF			p48		p50												
0.12pF			p48		p50												
0.13pF			p48		p50												
0.15pF			p48		p50												
0.16pF			p48		p50												
0.18pF			p48		p50												
0.20pF	p46	p47	p48	p50	p50												
0.22pF			p48		p50												
0.24pF			p48		p50												
0.27pF			p48		p50												
0.30pF	p46	p47	p48	p50	p50												
0.33pF			p48		p50												
0.36pF			p48		p50												
0.39pF			p48		p50												
0.43pF			p48		p50												
0.47pF		p47	p48		p50												
0.51pF			p48		p50												
0.56pF		p47	p48		p50												
0.62pF			p48		p50												
0.68pF		p47	p48		p50												
0.75pF		p47	p48		p50												
0.82pF		p47	p48		p50												
0.91pF		p47	p48		p50												
1.0pF	p46	p47	p48	p50	p50												
1.1pF	p46	p47	p48	p50	p50												
1.2pF	p46	p47	p48	p50	p50												
1.3pF	p46	p47	p48	p50	p50												
1.5pF	p46	p47	p48	p50	p50												
1.6pF	p46	p47	p48	p50	p50												
1.8pF	p46	p47	p48	p50	p50												
2.0pF	p46	p47	p48	p50	p50												
2.2pF	p46	p47	p48	p50	p50												
2.4pF	p46	p47	p48	p50	p50												
2.7pF	p46	p47	p48	p50	p50												
3.0pF	p46	p47	p48	p50	p50												
3.3pF	p46	p47	p48	p50	p50												
3.6pF	p46	p47	p48	p50	p50												
3.9pF	p46	p47	p48	p50	p50												
4.0pF	p46	p47	p48	p50	p50												
4.3pF	p46	p47	p48	p50	p50												
4.7pF	p46	p47	p48	p50	p50												
5.0pF	p46	p47	p48	p50	p50												
5.1pF	p46	p47	p48	p50	p50												
5.6pF	p46	p47	p48	p50	p50												
6.0pF	p46	p47	p48	p50	p50												
6.2pF	p46	p47	p48	p50	p50												
6.8pF	p46	p47	p48	p50	p50												
7.0pF	p46	p47	p48	p50	p50												
7.5pF	p46	p47	p48	p50	p50												
8.0pF	p46	p47	p48	p50	p50												
8.2pF	p46	p47	p48	p50	p50												
9.0pF	p46	p47	p48	p50	p50												
9.1pF	p46	p47	p48	p50	p50												
10pF	p46	p47	p48	p50	p50	p52											

↓ Continued on the following page.

Capacitance Table

(→ GRT Series Temperature Compensating Type)

p00 ← Part Number List EIA: COG

L×W (mm)	0.6×0.3			1.0×0.5			1.6×0.8			2.0×1.25			3.2×1.6				
T max. (mm)	0.33			0.55			0.9			0.6	0.7	1.35	0.95	1.8			
Rated Voltage (Vdc)	100	50	25	100	50	25	100	50	25	25	100	50	100	100	50	25	16
Cap. / TC Code	COG	COG	COG	COG	COG	COG	COG	COG	COG	COG	COG	COG	COG	COG	COG	COG	COG
11pF	p46	p47	p49		p51												
12pF	p46	p47	p49	p50	p51	p52											
13pF	p46	p47	p49		p51												
15pF	p46	p47	p49	p50	p51	p52											
16pF	p46	p47	p49		p51												
18pF	p46	p47	p49	p50	p51	p52											
20pF	p46	p47	p49		p51												
22pF	p46	p47	p49	p50	p51	p52											
24pF	p46	p47	p49		p51												
27pF	p46	p47	p49	p50	p51	p52											
30pF	p46	p47	p49		p51												
33pF	p46	p47	p49	p50	p51	p52											
36pF	p46	p47	p49		p51												
39pF	p46	p47	p49	p50	p51	p52											
43pF	p46	p47	p49		p51												
47pF	p46	p47	p49	p50	p51	p52											
51pF	p46	p47	p49		p51												
56pF	p46	p47	p49	p50	p51	p52											
62pF	p46	p47	p49		p51												
68pF	p46	p47	p49	p50	p51	p52											
75pF	p46	p48	p49		p51												
82pF	p46	p48	p49	p50	p51	p52											
91pF	p46	p48	p49		p51												
100pF	p46	p48	p49	p50	p51	p52											
110pF		p48	p49		p51												
120pF		p48			p51	p52	p52										
130pF					p51												
150pF		p48	p49		p51	p52	p52										
160pF					p51												
180pF		p48	p49		p51	p52	p52										
200pF					p51												
220pF		p48	p49		p51	p52	p52										
240pF					p51												
270pF			p49		p51	p52	p52										
300pF					p51												
330pF			p49		p51	p52	p52										
360pF					p52												
390pF			p49		p52	p52	p52										
430pF					p52												
470pF			p49		p52	p52	p52										
510pF					p52												
560pF			p49		p52	p52	p52										
620pF					p52												
680pF			p49		p52	p52	p52										
750pF					p52												
820pF			p49		p52	p52	p52										
910pF			p49		p52												
1000pF			p50		p52	p52	p52										
1200pF							p52	p52	p52								
1500pF							p52	p52	p52								
1800pF								p52		p53	p53						
2200pF								p52		p53	p53						
2700pF								p52			p53						
3300pF								p52			p53						
3900pF								p52									p53

↓ Continued on the following page.

Capacitance Table

(→ GRT Series Temperature Compensating Type)

p00 ← Part Number List EIA: C0G

L×W (mm)	0.6×0.3			1.0×0.5			1.6×0.8			2.0×1.25				3.2×1.6			
T max. (mm)	0.33			0.55			0.9			0.6	0.7	1.35	0.95	1.8			
Rated Voltage (Vdc)	100	50	25	100	50	25	100	50	25	25	100	50	100	100	50	25	16
Cap. / TC Code	C0G	C0G	C0G	C0G	C0G	C0G	C0G	C0G	C0G	C0G	C0G	C0G	C0G	C0G	C0G	C0G	C0G
4300pF								p52									
4700pF								p52	p52					p53			
5100pF								p52									
5600pF								p52	p52					p53			
6800pF								p52	p52					p53			
8200pF								p52	p52					p53			
10000pF								p52	p52					p53			
18000pF													p53	p53			
22000pF													p53	p53			
56000pF																p53	
68000pF																p53	
82000pF																p53	
0.10μF															p53	p53	p53
0.12μF																	p53 p53

Capacitance Table

GRT Series High Dielectric Constant Type

p00 ← Part Number List EIA: X6S X7S X5R X7R X7T

L×W (mm)	0.6×0.3																		1.0×0.5														
T max. (mm)	0.33															0.35			0.39			0.22											
Rated Voltage (Vdc)	35			25			16			10			6.3			4			6.3			4			2.5			6.3			4		
Cap. / TC Code	X5R	X7R	X6S	X5R	X7S	X6S	X5R	X7R	X7S	X6S	X5R	X7R	X7S	X6S	X5R	X6S	X5R	X6S	X5R	X6S	X7T	X6S	X7T	X7T	X6S	X5R	X6S						
100pF				p54																													
150pF		p54	p54	p54																													
220pF				p54																													
270pF																																	
330pF				p54																													
470pF		p54	p54	p54																													
680pF				p54																													
820pF																																	
1000pF		p54	p54	p54																													
1500pF												p54																					
2200pF												p54	p54			p54																	
2700pF																																	
3300pF												p54	p54			p54																	
4700pF				p54								p54	p54			p54																	
5600pF																																	
6800pF				p54								p54	p54			p54																	
10000pF				p54			p54	p54				p54	p54			p54	p54																
15000pF							p54					p54				p54	p54																
22000pF							p54					p54				p54	p54																
33000pF							p54					p54				p54	p54																
39000pF																																	
47000pF							p54					p54				p54	p54																
56000pF																																	
68000pF							p54					p54				p54	p54	p54															
82000pF																		p54															
0.10μF	p54		p54	p54	p54	p54	p54		p54	p54	p54		p54	p54	p54	p54																	
0.15μF																																	
0.22μF												p54				p54	p54	p54								p54	p54	p54					
0.33μF																		p54															
0.47μF																		p54															
0.68μF																																	
1.0μF																		p54	p54	p54	p54	p54	p54	p54									
1.5μF																																	
2.2μF																																	
3.3μF																																	
4.7μF																																	
6.8μF																																	
10μF																																	
15μF																																	
22μF																																	
33μF																																	
47μF																																	
100μF																																	

Continued on the following page. ↗

Capacitance Table

(→ GRT Series High Dielectric Constant Type)

p00 ← Part Number List EIA: X6S X7S X5R X7R X7T

L×W (mm)	1.0×0.5																														
	0.33				0.55																0.6				0.65						
T max. (mm)	10	6.3	50	35	25				16				10				6.3				4				35	25	16	10	6.3	4	10
Rated Voltage (Vdc)	10	6.3	50	35	25				16				10				6.3				4				35	25	16	10	6.3	4	10
Cap. / TC Code	X5R	X5R	X7R	X6S	X5R	X7R	X6S	X5R	X7R	X6S	X5R	X7R	X6S	X5R	X7R	X6S	X5R	X7R	X6S	X5R	X7R	X6S	X5R	X6S	X7S	X5R	X5R	X5R			
100pF																															
150pF																															
220pF			p54																												
270pF			p54																												
330pF			p54																												
470pF			p54																												
680pF			p54																												
820pF			p54																												
1000pF			p54																												
1500pF			p54																												
2200pF			p54																												
2700pF			p54																												
3300pF			p54																												
4700pF			p54																												
5600pF						p55																									
6800pF			p55																												
10000pF			p55			p55			p55																						
15000pF			p55																												
22000pF			p55			p55			p55									p55													
33000pF			p55			p55			p55																						
39000pF			p55																												
47000pF			p55			p55			p55																						
56000pF			p55																												
68000pF			p55						p55																						
82000pF			p55																												
0.10μF			p55			p55			p55																						
0.15μF																															
0.22μF				p55	p55		p55	p55	p55		p55	p55		p55		p55	p55														
0.33μF																		p55		p55	p55										
0.47μF				p55				p55		p55	p55		p55		p55		p55	p55													
0.68μF																		p55		p55	p55										
1.0μF	p54	p54						p55				p55		p55		p55	p55	p55					p55	p55	p55	p55					
1.5μF																															
2.2μF		p54																p55		p55	p55										
3.3μF																															
4.7μF																															
6.8μF																											p55	p55	p55		
10μF																															
15μF																															
22μF																															
33μF																															
47μF																															
100μF																															

Continued on the following page. ↗

Capacitance Table

(→ GRT Series High Dielectric Constant Type)

p00 ← Part Number List EIA: X6S X7S X5R X7R X7T

L×W (mm)	1.0×0.5										1.6×0.8																
	0.65		0.7						0.9						0.95				1.0								
T max. (mm)	6.3	4	25	16	10	6.3	2.5	100	50	35	25	16	6.3	4	25	16	10	2.5	50	35							
Rated Voltage (Vdc)	6.3	4	25	16	10	6.3	2.5	100	50	35	25	16	6.3	4	25	16	10	2.5	50	35							
Cap. / TC Code	X6S	X6S	X5R	X6S	X5R	X7S	X6S	X7S	X6S	X7R	X5R	X6S	X5R	X7R	X7R	X5R	X6S	X5R	X5R	X6S	X5R	X5R	X5R	X5R	X5R	X6S	X5R
100pF																											
150pF																											
220pF																											
270pF																											
330pF																											
470pF																											
680pF																											
820pF																											
1000pF																											
1500pF																											
2200pF																											
2700pF																											
3300pF										p55																	
4700pF																											
5600pF																											
6800pF																											
10000pF										p55																	
15000pF																											
22000pF																											
33000pF																											
39000pF																											
47000pF																											
56000pF																											
68000pF																											
82000pF																											
0.10μF																											
0.15μF															p55												
0.22μF															p55												
0.33μF																	p55										
0.47μF															p55	p55											
0.68μF																											
1.0μF										p55	p55				p55	p55			p55								
1.5μF																											
2.2μF			p55	p55	p55	p55	p55	p55				p55											p55	p55			
3.3μF																											
4.7μF	p55	p55																	p55	p55	p55				p55		
6.8μF																											
10μF															p55	p55	p55					p55	p55				
15μF																											
22μF																										p55	
33μF																											
47μF																											
100μF																											

Continued on the following page. ↗

Capacitance Table

(→ GRT Series High Dielectric Constant Type)

p00 ← Part Number List EIA: X6S X7S X5R X7R X7T

L×W (mm)	1.6×0.8												2.0×1.25													
	1.0												0.95			1.35			1.4							
T max. (mm)	1.0												0.95			1.35			1.4							
Rated Voltage (Vdc)	25			16			10			6.3			4			16	10	100	50	16	50	35	25	16	10	
Cap. / TC Code	X7S	X6S	X5R	X7S	X6S	X7T	X6S	X5R	X7T	X6S	X5R	X6S	X5R	X6S	X5R	X7R	X7R	X7R	X5R	X6S	X7R	X6S	X7R	X6S	X7R	X5R
100pF																										
150pF																										
220pF																										
270pF																										
330pF																										
470pF																										
680pF																										
820pF																										
1000pF																										
1500pF																										
2200pF																										
2700pF																										
3300pF																										
4700pF																										
5600pF																										
6800pF																										
10000pF																										
15000pF																										
22000pF																										
33000pF																										
39000pF																										
47000pF																										
56000pF																										
68000pF																										
82000pF																										
0.10μF																										
0.15μF																										
0.22μF																										
0.33μF																										
0.47μF																										
0.68μF																										
1.0μF																										
1.5μF																										
2.2μF	p55	p56																								
3.3μF																										
4.7μF		p56																								
6.8μF																										
10μF			p56																							
15μF																										
22μF																										
33μF																										
47μF																										
100μF																										

Continued on the following page. ↗

Capacitance Table

(→ GRT Series High Dielectric Constant Type)

p00 ← Part Number List EIA: X6S X7S X5R X7R X7T

L×W (mm)	2.0×1.25													3.2×1.6																	
	1.4	1.45												0.95	1.25						1.8										
T max. (mm)	6.3	50		25		16		10		6.3		4		2.5		35	50		25		16		50			35		25			
Rated Voltage (Vdc)	X5R	X7S	X7S	X5R	X7S	X5R	X7T	X6S	X7T	X5R	X6S	X5R	X6S	X5R	X6S	X5R	X6S	X5R	X6S	X5R	X6S	X5R	X7R	X6S	X5R	X6S	X5R	X6S	X5R		
Cap. / TC Code	X5R	X7S	X7S	X5R	X7S	X5R	X7T	X6S	X7T	X5R	X6S	X5R	X6S	X5R	X6S	X5R	X6S	X5R	X6S	X5R	X6S	X5R	X7R	X6S	X5R	X6S	X5R	X6S	X5R		
100pF																															
150pF																															
220pF																															
270pF																															
330pF																															
470pF																															
680pF																															
820pF																															
1000pF																															
1500pF																															
2200pF																															
2700pF																															
3300pF																															
4700pF																															
5600pF																															
6800pF																															
10000pF																															
15000pF																															
22000pF																															
33000pF																															
39000pF																															
47000pF																															
56000pF																															
68000pF																															
82000pF																															
0.10μF																															
0.15μF																															
0.22μF																															
0.33μF																															
0.47μF																															
0.68μF																															
1.0μF																															
1.5μF																															
2.2μF																															
3.3μF																															
4.7μF																															
6.8μF																															
10μF																															
15μF																															
22μF																															
33μF																															
47μF																															
100μF																															

Continued on the following page. ↗

Capacitance Table

(→ GRT Series High Dielectric Constant Type)

p00 ← Part Number List EIA: X6S X7S X5R X7R X7T

L×W (mm)	3.2×1.6				3.2×2.5												
	1.8				1.5	2.2			2.7								
T max. (mm)	16	10	6.3		25	50	6.3	50	16	10	6.3		4				
Rated Voltage (Vdc)	16	10	6.3		25	50	6.3	50	16	10	6.3		4				
Cap. / TC Code	X6S	X5R	X6S	X5R	X5R	X6S	X5R	X5R	X7R	X6S	X6S	X6S	X7R	X7S	X5R	X7S	
100pF																	
150pF																	
220pF																	
270pF																	
330pF																	
470pF																	
680pF																	
820pF																	
1000pF																	
1500pF																	
2200pF																	
2700pF																	
3300pF																	
4700pF																	
5600pF																	
6800pF																	
10000pF																	
15000pF																	
22000pF																	
33000pF																	
39000pF																	
47000pF																	
56000pF																	
68000pF																	
82000pF																	
0.10μF																	
0.15μF																	
0.22μF																	
0.33μF																	
0.47μF																	
0.68μF																	
1.0μF																	
1.5μF																	
2.2μF																	
3.3μF								p56	p56								
4.7μF									p56	p56							
6.8μF																	
10μF																	
15μF																	
22μF	p56																
33μF																	
47μF		p56	p56														
100μF															p56	p56	p56

Capacitance Table

GCM Series Temperature Compensating Type (3.2×1.6mm: p.24 to 25, 3.2×2.5 – 5.7×5.0mm: p.26)

p00 ← Part Number List EIA: **COG** **U2J** Murata Temperature Characteristic: **X8G** **ZLM**

L×W (mm)	0.6×0.3			1.0×0.5			1.6×0.8						2.0×1.25																
T max. (mm)	0.33		0.55		0.9						0.7			0.95			1.0		1.4		1.45								
Rated Voltage (Vdc)	50	25	50			100		80	63	50		100	80	50	100	80	50	630	250	80	50	630	250						
Cap. / TC Code	COG	COG	COG	X8G	COG	U2J	X8G	COG	COG	COG	U2J	X8G	COG	COG	X8G	X8G	ZLM	COG	COG	X8G	COG	COG	U2J	COG	COG	X8G	COG	COG	U2J
0.10pF	p58	p59	p61	p64																									
0.11pF	p58	p59	p61																										
0.12pF	p58	p59	p61																										
0.13pF	p58	p59	p61																										
0.15pF	p58	p59	p61																										
0.16pF	p58	p59	p61																										
0.18pF	p58	p59	p61																										
0.20pF	p58	p59	p61	p64																									
0.22pF	p58	p59	p61																										
0.24pF	p58	p59	p61																										
0.27pF	p58	p59																											
0.30pF	p58	p59	p61	p64																									
0.33pF	p58	p59	p61																										
0.36pF	p58	p59	p61																										
0.39pF	p58	p59	p61																										
0.40pF	p58	p59	p61	p64																									
0.43pF	p58	p59	p61																										
0.47pF	p58	p59	p61																								p67		
0.50pF	p58	p59	p61	p64																							p67		
0.51pF	p58	p59	p61																								p67		
0.56pF	p58	p59	p61																								p67		
0.60pF	p58	p59	p61	p64																							p67		
0.62pF	p58	p59	p61																								p67		
0.68pF	p58	p59	p61																								p67		
0.70pF	p58	p59	p61	p64																							p67		
0.75pF	p58	p59	p61	p64																							p67		
0.80pF	p58	p60	p61	p64																							p67		
0.82pF	p58	p60	p61																								p67		
0.90pF	p58	p60	p61	p64																							p67		
0.91pF	p58	p60	p61																								p67		
1.0pF	p58	p60	p61	p64																							p68		
1.1pF	p58	p60	p61	p64																							p68		
1.2pF	p58	p60	p61	p64																							p68		
1.3pF	p58	p60	p61	p64																							p68		
1.4pF			p61	p64																							p68		
1.5pF	p58	p60	p61	p64																							p68		
1.6pF	p58	p60	p61	p64																							p68		
1.7pF			p61	p64																							p68		
1.8pF	p58	p60	p61	p64																							p68		
1.9pF			p61	p64																							p68		
2.0pF	p58	p60	p61	p64																							p68		
2.1pF			p61	p64																							p68		
2.2pF	p58	p60	p61	p64																							p68		
2.3pF			p61	p64																							p68		
2.4pF	p58	p60	p61	p64																							p68		
2.5pF			p61	p64																							p68		
2.6pF			p61	p64																							p68		
2.7pF	p58	p60	p61	p65																							p68		
2.8pF			p61	p65																							p68		
2.9pF			p61	p65																							p68		
3.0pF	p58	p60	p61	p65																							p68		
3.1pF			p61	p65																							p68		
3.2pF			p61	p65																							p68		
3.3pF	p58	p60	p61	p65																							p68		
3.4pF			p62	p65																							p68		

↓ Continued on the following page.

Capacitance Table

(→ GCM Series Temperature Compensating Type) (3.2×1.6mm: p.24 to 25, 3.2×2.5 – 5.7×5.0mm: p.26)

p00 ← Part Number List EIA: **COG** **U2J** Murata Temperature Characteristic: **X8G** **ZLM**

L×W (mm)	0.6×0.3		1.0×0.5		1.6×0.8								2.0×1.25																				
	T max. (mm)		0.33		0.55		0.9								0.7			0.95			1.0		1.4		1.45								
Rated Voltage (Vdc)	50	25	50		100		80	63	50		X8G	COG	COG	COG	U2J	X8G	COG	COG	X8G	X8G	ZLM	COG	COG	X8G	COG	COG	U2J	COG	COG	X8G	COG	COG	U2J
Cap. / TC Code	COG	COG	COG	X8G	COG	U2J	X8G	COG	COG	COG	U2J	X8G	COG	COG	X8G	X8G	ZLM	COG	COG	X8G	COG	COG	U2J	COG	COG	X8G	COG	COG	U2J	COG	COG	U2J	
3.5pF			p62	p65	p68																												
3.6pF	p58	p60	p62	p65	p68																												
3.7pF			p62	p65	p68																												
3.8pF			p62	p65	p68																												
3.9pF	p58	p60	p62	p65	p68																												
4.0pF	p58	p60	p62	p65	p68																												
4.1pF			p62	p65	p68																												
4.2pF			p62	p65	p68																												
4.3pF	p58	p60	p62	p65	p68																												
4.4pF			p62	p65	p68																												
4.5pF			p62	p65	p68																												
4.6pF			p62	p65	p68																												
4.7pF	p58	p60	p62	p65	p68																												
4.8pF			p62	p65	p68																												
4.9pF			p62	p65	p68																												
5.0pF	p58	p60	p62	p65	p68																												
5.1pF	p58	p60	p62	p65	p68																												
5.2pF			p62	p65	p68																												
5.3pF			p62	p65	p68																												
5.4pF			p62	p65	p68																												
5.5pF			p62	p65	p68																												
5.6pF	p58	p60	p62	p65	p69																												
5.7pF			p62	p65	p69																												
5.8pF			p62	p65	p69																												
5.9pF			p62	p65	p69																												
6.0pF	p58	p60	p62	p65	p69																												
6.1pF			p62	p65	p69																												
6.2pF	p58	p60	p62	p65	p69																												
6.3pF			p62	p65	p69																												
6.4pF			p62	p65	p69																												
6.5pF			p62	p65	p69																												
6.6pF			p62	p65	p69																												
6.7pF			p62	p65	p69																												
6.8pF	p58	p60	p62	p65	p69																												
6.9pF			p62	p65	p69																												
7.0pF	p58	p60	p62	p65	p69																												
7.1pF			p62	p65	p69																												
7.2pF			p62	p65	p69																												
7.3pF			p62	p65	p69																												
7.4pF			p62	p65	p69																												
7.5pF	p58	p60	p62	p65	p69																												
7.6pF			p62	p65	p69																												
7.7pF			p62	p65	p69																												
7.8pF			p62	p65	p69																												
7.9pF			p62	p65	p69																												
8.0pF	p58	p60	p62	p65	p69																												
8.1pF			p62	p66	p69																												
8.2pF	p58	p60	p62	p66	p69																												
8.3pF			p62	p66	p69																												
8.4pF			p62	p66	p69																												
8.5pF			p62	p66	p69																												
8.6pF			p62	p66	p69																												
8.7pF			p62	p66	p69																												
8.8pF			p62	p66	p69																												
8.9pF			p62	p66	p69																												

↓ Continued on the following page.

Capacitance Table

(→ GCM Series Temperature Compensating Type) (3.2×1.6mm: p.24 to 25, 3.2×2.5 – 5.7×5.0mm: p.26)

p00 ← Part Number List EIA: **COG** **U2J** Murata Temperature Characteristic: **X8G** **ZLM**

L×W (mm)	0.6×0.3		1.0×0.5		1.6×0.8						2.0×1.25																		
	T max. (mm)		0.33		0.55		0.9						0.7			0.95			1.0		1.4		1.45						
Rated Voltage (Vdc)	50	25	50		100		80	63	50		100	80	50	100	80	50	630	250	80	50	630	250							
Cap. / TC Code	COG	COG	COG	X8G	COG	U2J	X8G	COG	COG	COG	U2J	X8G	COG	COG	X8G	X8G	ZLM	COG	COG	X8G	COG	COG	U2J	COG	COG	X8G	COG	COG	U2J
9.0pF	p58	p60	p62	p66	p69																								
9.1pF	p58	p60	p63	p66	p69																								
9.2pF			p63	p66	p70																								
9.3pF			p63	p66	p70																								
9.4pF			p63	p66	p70																								
9.5pF			p63	p66	p70																								
9.6pF			p63	p66	p70																								
9.7pF			p63	p66	p70																								
9.8pF			p63	p66	p70																								
9.9pF			p63	p66	p70																								
10pF	p58	p60	p63	p66	p70	p71																	p75	p76					
11pF	p58	p60	p63	p66	p70	p71																							
12pF	p58	p60	p63	p66	p70	p71																	p75	p76					
13pF	p58	p60	p63	p66	p70	p71																							
15pF	p58	p60	p63	p66	p70	p72																	p75	p76					
16pF	p58	p60	p63	p66	p70	p72																							
18pF	p59	p60	p63	p66	p70	p72																	p75	p76					
20pF	p59	p60	p63	p66	p70	p72																							
22pF	p59	p60	p63	p66	p70	p72																	p75	p76					
24pF	p59	p60	p63	p66	p70	p72																							
27pF	p59	p60	p63	p66	p70	p72																	p75	p76					
30pF	p59	p60	p63	p66	p70	p72																							
33pF	p59	p60	p63	p66	p70	p72																	p76	p76					
36pF	p59	p60	p63	p66	p70	p72																							
39pF	p59	p60	p63	p66	p70	p72																	p76	p76					
43pF	p59	p60	p63	p66	p70	p72																							
47pF	p59	p60	p63	p66	p70	p72																	p76	p76					
51pF	p59	p60	p63	p66	p70	p72																							
56pF	p59	p60	p63	p66	p70	p72																	p76	p76					
62pF	p59	p60	p63	p66	p70	p72																							
68pF	p59	p60	p63	p66	p70	p72																	p76	p76					
75pF	p59	p60	p63	p66	p70	p72																							
82pF	p59	p61	p63	p66	p70	p72																	p76	p76					
91pF	p59	p61	p63	p67	p70	p72																							
100pF	p59	p61	p63	p67	p70	p72																	p76	p76	p77				
110pF			p63	p67	p70	p72																							
120pF			p63	p67	p70	p72																	p76	p76	p77				
130pF			p63	p67	p70	p72																							
150pF			p63	p67	p71	p72																	p76	p76	p77				
160pF			p63	p67	p71	p72																							
180pF			p63	p67	p71	p72																	p76	p76	p77				
200pF			p64	p67	p71	p72																							
220pF			p64	p67	p71	p72																	p76	p76	p77				
240pF			p64	p67	p71	p72																							
270pF			p64	p67	p71	p72																	p76	p76	p77				
300pF			p64	p67	p71	p72																							
330pF			p64	p67	p71	p72																	p76	p76	p77				
360pF			p64	p67	p71	p72																							
390pF			p64	p67	p71	p72																	p76	p76	p77				
430pF			p64	p67	p71	p72																							
470pF			p64	p67	p71	p73																	p76	p77	p77				
510pF			p64	p67	p71	p73																							
560pF			p64	p67	p71	p73																	p76	p77	p77				
620pF			p64	p67	p71	p73																							
680pF			p64	p67	p71	p73																	p77	p77				p77	

↓ Continued on the following page.

Capacitance Table

(→ GCM Series Temperature Compensating Type) (3.2×1.6mm: p.24 to 25, 3.2×2.5 – 5.7×5.0mm: p.26)

p00 ← Part Number List EIA: **COG** **U2J** Murata Temperature Characteristic: **X8G** **ZLM**

L×W (mm)	0.6×0.3		1.0×0.5		1.6×0.8						2.0×1.25																		
	T max. (mm)		0.33		0.55		0.9						0.7			0.95			1.0		1.4		1.45						
Rated Voltage (Vdc)	50	25	50		100		80	63	50		100	80	50	100	80	50	630	250	80	50	630	250							
Cap. / TC Code	COG	COG	COG	X8G	COG	U2J	X8G	COG	COG	COG	U2J	X8G	COG	COG	X8G	X8G	ZLM	COG	COG	X8G	COG	COG	U2J	COG	COG	X8G	COG	COG	U2J
750pF			p64	p67	p71		p73																						
820pF			p64	p67	p71		p73																	p77	p77			p77	
910pF			p64	p67	p71		p73																						
1000pF			p64	p67	p71	p71	p73					p74					p75							p77	p77			p77	
1100pF						p71					p73	p74	p74			p75	p75												
1200pF					p71	p71					p73	p74	p74			p75	p75						p77	p77			p77		
1300pF					p71	p71					p73	p74	p74			p75	p75												
1500pF					p71	p71					p73	p74	p74			p75	p75						p77	p77			p77		
1600pF						p71		p73	p73	p73	p74	p74	p74																
1800pF						p71		p73	p73	p73	p74	p74	p74										p77	p77			p77		
2000pF						p71		p73	p73	p73	p74	p74	p74																
2200pF						p71		p73	p73	p73	p74	p74	p74										p77	p77			p77		
2400pF						p71		p73	p73	p73	p74	p74	p74																
2700pF						p71		p73	p73	p73	p74	p74	p74										p77						p78
3000pF						p71		p73	p73	p73	p74		p74			p75													
3300pF						p71		p73	p73	p73	p74		p74			p75											p77	p78	
3600pF						p71		p73	p73	p73	p74					p75													
3900pF						p71		p73	p73	p73	p74					p75											p77	p78	
4300pF						p71					p74	p74			p74	p75							p75						
4700pF						p71					p74	p74			p75	p75											p77	p78	
5100pF						p71						p74	p74				p75						p75						
5600pF						p71						p74	p74				p75						p75				p78	p78	
6200pF						p71						p74	p74				p75						p75				p77		
6800pF						p71						p74	p74				p75						p75				p77		p78
7500pF						p71						p74	p74				p75						p75				p77		
8200pF						p71						p74	p74				p75						p75				p77		p78
9100pF						p71						p74	p74				p75						p75				p77		
10000pF						p71						p74	p74				p75						p75				p77		p78
11000pF																	p75												
12000pF																	p75	p75											
13000pF																	p75	p75											
15000pF																	p75	p75											
16000pF																													
18000pF																										p77	p77		
20000pF																										p77	p77		
22000pF																										p77	p77		
27000pF																													
33000pF																													
39000pF																													
43000pF																													
47000pF																													
51000pF																													
56000pF																													
62000pF																													
68000pF																													
75000pF																													
82000pF																													
91000pF																													
0.10μF																													

Continued on the following page. ↗

Capacitance Table

(→ GCM Series Temperature Compensating Type) (0.6×0.3 – 2.0×1.25mm: p.20 to 23, 3.2×2.5 – 5.7×5.0mm: p.26)

p00 ← Part Number List EIA: **COG** **U2J** Murata Temperature Characteristic: **X8G** **ZLM**

L×W (mm)	3.2×1.6																												
	0.95				1.0				1.25				1.8																
T max. (mm)	100		80		50		1000		630		1000		630		250		50		1000		630		250		100		50		
Rated Voltage (Vdc)	COG	X8G	COG	COG	X8G	COG	U2J	COG	U2J	COG	U2J	COG	U2J	COG	U2J	COG	COG	U2J	COG	U2J	COG	COG	COG	COG	COG	COG	COG	COG	
Cap. / TC Code	COG	X8G	COG	COG	X8G	COG	U2J	COG	U2J	COG	U2J	COG	U2J	COG	U2J	COG	COG	U2J	COG	U2J	COG	COG	COG	COG	COG	COG	COG	COG	
9.0pF																													
9.1pF																													
9.2pF																													
9.3pF																													
9.4pF																													
9.5pF																													
9.6pF																													
9.7pF																													
9.8pF																													
9.9pF																													
10pF							p79	p79	p79	p80																			
11pF																													
12pF							p79	p79	p79	p80																			
13pF																													
15pF							p79	p79	p79	p80																			
16pF																													
18pF							p79	p79	p79	p80																			
20pF																													
22pF							p79	p79	p79	p80																			
24pF																													
27pF							p79	p79	p79	p80																			
30pF																													
33pF							p79	p79	p79	p80																			
36pF																													
39pF							p79	p79	p79	p80																			
43pF																													
47pF							p79	p79	p80	p80																			
51pF																													
56pF							p79	p79	p80	p80																			
62pF																													
68pF							p79	p79	p80	p80																			
75pF																													
82pF							p79	p79	p80	p80																			
91pF																													
100pF							p79	p79	p80	p80																			
110pF																													
120pF							p79	p79	p80	p80																			
130pF																													
150pF							p79	p79	p80	p80																			
160pF																													
180pF							p79	p79	p80	p80																			
200pF																													
220pF							p79	p79	p80	p80																			
240pF																													
270pF							p79	p79	p80	p80																			
300pF																													
330pF							p79	p79	p80	p80																			
360pF																													
390pF							p79		p80	p80			p80																
430pF																													
470pF							p79		p80	p80			p80																
510pF																													
560pF									p80	p80	p80	p80																	
620pF																													
680pF									p80	p80	p80	p80																	

↓ Continued on the following page.

Capacitance Table

(→ GCM Series Temperature Compensating Type) (0.6×0.3 – 2.0×1.25mm: p.20 to 23, 3.2×2.5 – 5.7×5.0mm: p.26)

p00 ← Part Number List EIA: **COG** **U2J** Murata Temperature Characteristic: **X8G** **ZLM**

L×W (mm)	3.2×1.6																											
	0.95					1.0				1.25				1.8														
T max. (mm)	100		80		50		1000		630		1000		630		250		50		1000		630		250		100		50	
Rated Voltage (Vdc)	COG	X8G	COG	COG	X8G	COG	U2J	COG	U2J	COG	U2J	COG	U2J	COG	U2J	COG	U2J	COG	COG	U2J	COG	U2J	COG	COG	COG	COG	COG	
Cap. / TC Code	COG	X8G	COG	COG	X8G	COG	U2J	COG	U2J	COG	U2J	COG	U2J	COG	U2J	COG	U2J	COG	COG	U2J	COG	U2J	COG	COG	COG	COG	COG	
750pF																												
820pF								p80	p80											p81	p81							
910pF																												
1000pF								p80	p80												p81	p81						
1100pF																												
1200pF								p80	p80																			
1300pF																												
1500pF								p80	p80																			
1600pF		p78																										
1800pF		p78						p80	p80																			
2000pF		p78																										
2200pF		p78							p80			p80																
2400pF		p78																										
2700pF		p78										p80	p80															
3000pF		p78																										
3300pF		p78											p81									p81						
3600pF	p78	p78																										
3900pF	p78	p78																				p81	p81					
4300pF	p78	p78																										
4700pF	p78	p78																										
5100pF	p78	p78																										
5600pF	p78	p78																										
6200pF																												
6800pF	p78																											
7500pF	p78																											
8200pF	p78																											
9100pF	p78																											
10000pF	p78																											
11000pF																												
12000pF															p81													
13000pF																												
15000pF																												
16000pF																												
18000pF																												
20000pF																												
22000pF																												
27000pF																												
33000pF																												
39000pF																												
43000pF																												
47000pF																												
51000pF																												
56000pF																												
62000pF																												
68000pF																												
75000pF																												
82000pF																												
91000pF																												
0.10μF																												

Continued on the following page. ↗

Capacitance Table

(→ GCM Series Temperature Compensating Type) (0.6×0.3 – 2.0×1.25mm: p.20 to 23, 3.2×1.6mm: p.24 to 25)

p00 ← Part Number List EIA: **COG** **U2J** Murata Temperature Characteristic: **X8G** **ZLM**

L×W (mm)	3.2×2.5						4.5×3.2				5.7×5.0					
	1.0		1.25		1.5		2.0		2.85		1.5		2.0			
T max. (mm)	630	1000	630	1000	630	1000	630	630	1000	630	1000	630	1000	630	1000	630
Rated Voltage (Vdc)	630	1000	630	1000	630	1000	630	630	1000	630	1000	630	1000	630	1000	630
Cap. / TC Code	U2J	U2J	U2J	U2J	U2J	U2J	COG	U2J	U2J	U2J	U2J	U2J	U2J	U2J	U2J	U2J
750pF																
820pF																
910pF																
1000pF																
1100pF																
1200pF	p81	p81														
1300pF																
1500pF	p81			p81												
1600pF																
1800pF	p81					p81										
2000pF																
2200pF	p81					p81										
2400pF																
2700pF									p82							
3000pF																
3300pF									p82							
3600pF																
3900pF											p82					
4300pF																
4700pF											p82					
5100pF																
5600pF			p81										p82			
6200pF																
6800pF					p81								p82			
7500pF																
8200pF																p82
9100pF																p82
10000pF																p82
11000pF																
12000pF											p82					
13000pF																
15000pF																p82
16000pF																p82
18000pF																p82
20000pF																p82
22000pF																p82
27000pF															p82	
33000pF										p81						p82
39000pF																p82
43000pF																
47000pF																p82
51000pF																
56000pF																
62000pF																
68000pF																
75000pF																
82000pF																
91000pF																
0.10μF																

Capacitance Table

GCM Series High Dielectric Constant Type

p00 ← Part Number List EIA: X7S X7T X7R X8R Murata Temperature Characteristic: X8L X8M

L×W (mm)	0.6×0.3			1.0×0.5										1.6×0.8													
	0.33			0.55					0.6	0.7	0.9										1.0						
Rated Voltage (Vdc)	25	16	10	100	50	25	16	10	10	10	100	50	25	16	6.3	6.3											
Cap. / TC Code	X7R	X7R	X7R	X7R	X8L	X7R	X8L	X7R	X8L	X7R	X7S	X7S	X8R	X7R	X8L	X8R	X7R	X8L	X8R	X7R	X8L	X7R	X7S	X7R	X7T		
100pF	p83																										
120pF	p83																										
150pF	p83																										
180pF	p83																										
220pF	p83			p83	p84	p84																					
270pF	p83			p83	p84	p84																					
330pF	p83	p83		p83	p84	p84																					
390pF	p83			p83	p84	p84																					
470pF	p83			p83	p84	p84																					
560pF	p83			p83	p84	p84																					
680pF	p83	p83		p83	p84	p84																					
820pF	p83			p83	p84	p84																					
1000pF	p83			p83	p84	p84							p85			p86											
1200pF	p83		p83	p83	p84	p84							p85			p86											
1500pF	p83		p83	p83	p84	p84							p85			p86											
1800pF	p83	p83	p83	p83	p84	p84							p85			p86											
2200pF	p83	p83	p83	p83	p84	p84							p85			p86											
2700pF	p83	p83	p83	p83	p84	p84							p85			p86											
3300pF	p83	p83	p83	p83	p84	p84							p85			p86											
3900pF			p83	p83	p84	p84																					
4700pF			p83	p83	p84	p84			p84				p85			p86											
5600pF			p83			p84	p84	p84						p85	p85	p86											
6800pF			p83			p84	p84	p85					p85	p85	p85	p86											
8200pF			p83			p84	p84	p85					p85	p85	p85												
10000pF			p83			p84	p84	p85					p85	p85	p85	p86											
12000pF						p84		p85							p85	p86											
15000pF						p84		p85	p85						p85	p86	p86										
18000pF						p84		p85	p85						p85	p86											
22000pF						p84		p85	p85						p85	p86	p86										
27000pF								p85	p85	p85						p86	p86										
33000pF					p84	p84		p85	p85	p85					p86	p86											
39000pF								p85	p85	p85						p86											
47000pF					p84	p84		p85	p85	p85						p86	p86										
56000pF										p85						p86											
68000pF					p84	p84				p85						p86											
82000pF										p85						p86											
0.10μF					p84	p84	p84	p85		p85	p85					p86											
0.12μF																											
0.15μF										p85							p86								p86	p86	
0.18μF																									p86	p86	
0.22μF										p85							p86	p86							p86	p86	
0.27μF																										p86	
0.33μF																										p86	
0.39μF																										p86	
0.47μF													p85													p86	
0.56μF																											
0.68μF																											
0.82μF																											p86
1.0μF																											p86
1.5μF																											
2.2μF																											p86
3.3μF																											
4.7μF																											
10μF																											p86
22μF																											
47μF																											
100μF																											

Continued on the following page. ↗

Capacitance Table

(→ GCM Series High Dielectric Constant Type)

p00 ← Part Number List EIA: X7S X7T X7R X8R Murata Temperature Characteristic: X8L X8M

L×W (mm)	1.6×0.8	2.0×1.25																									
	T max. (mm)	0.95					1.4										1.45										
Rated Voltage (Vdc)	4	100	50	25	16	100	50	35	25	16	10	6.3	100	35													
Cap. / TC Code	X7T	X8R	X7R	X8R	X7R	X7R	X8R	X7R	X8L	X8R	X7R	X8L	X7R	X7S	X8L	X8R	X7R	X8L	X7R	X7R	X7S	X7R	X7S	X8L	X7S		
100pF																											
120pF																											
150pF																											
180pF																											
220pF																											
270pF																											
330pF																											
390pF																											
470pF																											
560pF																											
680pF																											
820pF																											
1000pF																											
1200pF																											
1500pF																											
1800pF																											
2200pF																											
2700pF																											
3300pF																											
3900pF																											
4700pF																											
5600pF																											
6800pF																											
8200pF																											
10000pF		p86			p87																						
12000pF																											
15000pF		p86			p87																						
18000pF																											
22000pF		p86			p87																						
27000pF			p86							p87																	
33000pF			p86						p87	p87		p87															
39000pF			p86							p87																	
47000pF									p87	p87		p87															
56000pF										p87																	
68000pF										p87		p87															
82000pF										p87																	
0.10μF										p87		p87															
0.12μF											p87																
0.15μF											p87																
0.18μF											p87																
0.22μF												p87															
0.27μF													p87														
0.33μF														p87													
0.39μF															p87												
0.47μF																p87											
0.56μF																	p87										
0.68μF																		p87									
0.82μF																			p87								
1.0μF																				p87							
1.5μF																					p87						
2.2μF																						p87					
3.3μF																							p87				
4.7μF																								p87			
10μF		p86																									
22μF																											
47μF																											
100μF																											

Continued on the following page. ↗

Capacitance Table

(→ GCM Series High Dielectric Constant Type)

p00 ← Part Number List EIA: X7S X7T X7R X8R Murata Temperature Characteristic: X8L X8M

L×W (mm)	2.0×1.25				3.2×1.6													3.2×2.5										
	1.45				1.25				1.8						1.9			2.2										
T max. (mm)	1.45				1.25				1.8						1.9			2.2										
Rated Voltage (Vdc)	25		16		100	50			25	100			50			25	16	10	6.3	35	25	100	10					
Cap. / TC Code	X8L	X7S	X8M	X7S	X7R	X8L	X8R	X8L	X8R	X8L	X7S	X8L	X8R	X7R	X7S	X8R	X7R	X7R	X7R	X7R	X8M	X7T	X7S	X8L	X7S	X8L		
100pF																												
120pF																												
150pF																												
180pF																												
220pF																												
270pF																												
330pF																												
390pF																												
470pF																												
560pF																												
680pF																												
820pF																												
1000pF																												
1200pF																												
1500pF																												
1800pF																												
2200pF																												
2700pF																												
3300pF																												
3900pF																												
4700pF																												
5600pF																												
6800pF																												
8200pF																												
10000pF																												
12000pF																												
15000pF																												
18000pF																												
22000pF																												
27000pF																												
33000pF																												
39000pF																												
47000pF																												
56000pF																												
68000pF																												
82000pF																												
0.10μF																												
0.12μF																												
0.15μF																												
0.18μF																												
0.22μF						p88																						
0.27μF																												
0.33μF																												
0.39μF																												
0.47μF																												
0.56μF																												
0.68μF																												
0.82μF																												
1.0μF																												
1.5μF																												
2.2μF																												
3.3μF																												
4.7μF		p88																										
10μF																												
22μF																												
47μF																												
100μF																												

Continued on the following page. ↗

Capacitance Table

(→ GCM Series High Dielectric Constant Type)

p00 ← Part Number List EIA: X7S X7T X7R X8R Murata Temperature Characteristic: X8L X8M

L×W (mm)	3.2×2.5																							
	2.7						2.85																	
T max. (mm)	50						25																	
Rated Voltage (Vdc)	50			35			25			16			10			6.3			25			2.5		
Cap. / TC Code	X8L	X7R	X7S	X7S	X7R	X7R	X7R	X7S	X7R	X8L	X7S	X7T												
100pF																								
120pF																								
150pF																								
180pF																								
220pF																								
270pF																								
330pF																								
390pF																								
470pF																								
560pF																								
680pF																								
820pF																								
1000pF																								
1200pF																								
1500pF																								
1800pF																								
2200pF																								
2700pF																								
3300pF																								
3900pF																								
4700pF																								
5600pF																								
6800pF																								
8200pF																								
10000pF																								
12000pF																								
15000pF																								
18000pF																								
22000pF																								
27000pF																								
33000pF																								
39000pF																								
47000pF																								
56000pF																								
68000pF																								
82000pF																								
0.10μF																								
0.12μF																								
0.15μF																								
0.18μF																								
0.22μF																								
0.27μF																								
0.33μF																								
0.39μF																								
0.47μF																								
0.56μF																								
0.68μF																								
0.82μF																								
1.0μF																								
1.5μF																								
2.2μF																								
3.3μF																								
4.7μF			p88																					
10μF	p88		p88	p88	p88																			
22μF						p89	p89			p89	p89													
47μF								p89	p89															
100μF												p89												

Capacitance Table

GC3 Series High Dielectric Constant Type

p00 ← Part Number List EIA: X7T

L×W (mm)	2.0×1.25		3.2×1.6						3.2×2.5				4.5×3.2				5.7×5.0						
	1.0	1.45	1.0	1.25		1.8		1.5	2.0		1.5	2.0		2.0		2.7							
T max. (mm)	250	250	450	250	630	450	250	630	450	250	630	250	630	450	250	630	450	250	630	450	250	630	250
Rated Voltage (Vdc)	250	250	450	250	630	450	250	630	450	250	630	250	630	450	250	630	450	250	630	450	250	630	250
Cap. / TC Code	X7T	X7T	X7T	X7T	X7T	X7T	X7T	X7T	X7T	X7T	X7T	X7T	X7T	X7T	X7T	X7T	X7T	X7T	X7T	X7T	X7T	X7T	X7T
10000pF	p91		p91		p91																		
15000pF	p91		p91				p91																
22000pF		p91								p91													
33000pF			p91				p91						p91										
47000pF							p91		p91				p91										
68000pF										p91			p91			p91							
0.10μF										p91			p91								p91		
0.15μF														p91		p91					p91		
0.22μF															p91						p91		p91
0.33μF																p91					p91		
0.47μF																					p91	p91	
0.68μF																						p91	
1.0μF																							p91

Capacitance Table

(→ GCJ Series High Dielectric Constant Type)

p00 ← Part Number List EIA: X7S X7T X7R X8R Murata Temperature Characteristic: X8L X8M

L×W (mm)	2.0×1.25							3.2×1.6																
	1.45				1.5	1.25			1.35				1.8			1.9								
T max. (mm)																								
Rated Voltage (Vdc)	35	25	16	10	100	1000	630	250	100	50	35	25	16	1000	630	250	100	50	35	25				
Cap. / TC Code	X8L	X8L	X7R	X8L	X7R	X7S	X7R	X7R	X7R	X7R	X8L	X7R	X8L	X7R	X7R	X7R	X8L	X7R	X7S	X7R	X7S	X8L	X7R	
1000pF							p97	p97																
1200pF																								
1500pF							p97	p97																
1800pF																								
2200pF							p97	p97																
2700pF																								
3300pF							p97	p97																
3900pF																								
4700pF							p97	p97																
5600pF																								
6800pF								p97							p97									
8200pF																								
10000pF								p97								p97								
12000pF																								
15000pF									p97								p97							
18000pF																								
22000pF									p97															
27000pF																								
33000pF																							p97	
39000pF																								
47000pF																							p97	
56000pF																								
68000pF										p97														
82000pF																								
0.10μF																							p97	
0.12μF	p96	p96																						
0.15μF	p96	p96								p97														
0.18μF	p96	p96								p97														
0.22μF	p96	p96								p97														
0.27μF		p96	p96		p96																			
0.33μF	p96	p96	p96		p96																			
0.39μF		p96	p96		p96																			
0.47μF	p96	p96	p96		p96					p97	p97													
0.56μF			p96	p96	p96					p97													p97	p97
0.68μF		p96	p96	p96	p96					p97													p97	p97
0.82μF		p96	p96	p96	p96					p97													p97	p97
1.0μF		p96	p96	p96	p96		p97			p97								p97	p97			p97	p97	
1.5μF			p96		p96																		p97	
2.2μF			p96		p96	p96							p97	p97	p97						p97	p97		
3.3μF													p97											
4.7μF					p96																		p97	p97
6.8μF																								
10μF							p97																	
22μF																								
47μF																								

Continued on the following page. ↗

Capacitance Table

(→ GCJ Series High Dielectric Constant Type)

p00 ← Part Number List EIA: X7S X7T X7R X8R Murata Temperature Characteristic: X8L X8M

L×W (mm)	3.2×1.6										3.2×2.5										4.5×3.2					
	1.9					2.0					1.5		2.0		2.3			2.8				2.85	1.5			
T max. (mm)	16					10					630		250		100			50				25		6.3	25	630
Rated Voltage (Vdc)	X8L	X7R	X8L	X7R	X7R	X7T	X8L	X7S	X7R	X7R	X7R	X7R	X8L	X7R	X7S	X7R	X7S	X8L	X7R	X8R	X7R	X7R	X8L	X7S	X7R	
Cap. / TC Code	X8L	X7R	X8L	X7R	X7R	X7T	X8L	X7S	X7R	X7R	X7R	X7R	X8L	X7R	X7S	X7R	X7S	X8L	X7R	X8R	X7R	X7R	X8L	X7S	X7R	
1000pF																										
1200pF																										
1500pF																										
1800pF																										
2200pF																										
2700pF																										
3300pF																										
3900pF																										
4700pF																										
5600pF																										
6800pF																										
8200pF																										
10000pF																										
12000pF																										
15000pF																										
18000pF																										
22000pF																										
27000pF																										
33000pF																										
39000pF																										
47000pF																										
56000pF																										
68000pF																										
82000pF																										
0.10μF																										
0.12μF																										
0.15μF																										
0.18μF																										
0.22μF																										
0.27μF																										
0.33μF																										
0.39μF																										
0.47μF																										
0.56μF																										
0.68μF																										
0.82μF																										
1.0μF																										
1.5μF																										
2.2μF																										
3.3μF	p97	p97																								
4.7μF	p97	p97																								
6.8μF																										
10μF		p97																								
22μF			p97	p97	p97																					
47μF																										

Continued on the following page. ↗

Capacitance Table

(→ GCJ Series High Dielectric Constant Type)

p00 ← Part Number List EIA: X7S X7T X7R X8R

Murata Temperature Characteristic: X8L X8M

L×W (mm)	4.5×3.2				5.7×5.0		
	1.5	2.0			2.0		
Rated Voltage (Vdc)	250	1000	630	250	1000	630	250
Cap. / TC Code	X7R	X7R	X7R	X7R	X7R	X7R	X7R
1000pF							
1200pF							
1500pF							
1800pF							
2200pF							
2700pF							
3300pF							
3900pF							
4700pF							
5600pF							
6800pF							
8200pF							
10000pF							
12000pF							
15000pF							
18000pF							
22000pF							
27000pF							
33000pF		p98	p98				
39000pF							
47000pF		p98	p98				
56000pF							
68000pF					p98		
82000pF							
0.10μF			p98		p98	p98	
0.12μF							
0.15μF	p98					p98	
0.18μF							
0.22μF				p98		p98	
0.27μF							
0.33μF				p98			p98
0.39μF							
0.47μF				p98			p98
0.56μF							
0.68μF							p98
0.82μF							
1.0μF							p98
1.5μF							
2.2μF							
3.3μF							
4.7μF							
6.8μF							
10μF							
22μF							
47μF							

Capacitance Table

GCQ Series Temperature Compensating Type

p00 ← Part Number List

EIA: **COG**

L×W (mm)	1.0×0.5	L×W (mm)	1.0×0.5	L×W (mm)	1.0×0.5
T max. (mm)	0.55	T max. (mm)	0.55	T max. (mm)	0.55
Rated Voltage (Vdc)	50	Rated Voltage (Vdc)	50	Rated Voltage (Vdc)	50
Cap. / TC Code	COG	Cap. / TC Code	COG	Cap. / TC Code	COG
0.10pF	p101	3.1pF	p102	8.6pF	p104
0.11pF	p101	3.2pF	p102	8.7pF	p104
0.12pF	p101	3.3pF	p102	8.8pF	p104
0.13pF	p101	3.4pF	p102	8.9pF	p104
0.15pF	p101	3.5pF	p102	9.0pF	p104
0.16pF	p101	3.6pF	p102	9.1pF	p104
0.18pF	p101	3.7pF	p102	9.2pF	p104
0.20pF	p101	3.8pF	p102	9.3pF	p104
0.22pF	p101	3.9pF	p102	9.4pF	p105
0.24pF	p101	4.0pF	p103	9.5pF	p105
0.25pF	p101	4.1pF	p103	9.6pF	p105
0.27pF	p101	4.2pF	p103	9.7pF	p105
0.30pF	p101	4.3pF	p103	9.8pF	p105
0.33pF	p101	4.4pF	p103	9.9pF	p105
0.36pF	p101	4.5pF	p103	10pF	p105
0.39pF	p101	4.6pF	p103	11pF	p105
0.40pF	p101	4.7pF	p103	12pF	p105
0.43pF	p101	4.8pF	p103	13pF	p105
0.45pF	p101	4.9pF	p103	14pF	p105
0.47pF	p101	5.0pF	p103	15pF	p105
0.50pF	p101	5.1pF	p103	16pF	p105
0.51pF	p101	5.2pF	p103	17pF	p105
0.56pF	p101	5.3pF	p103	18pF	p105
0.60pF	p101	5.4pF	p103	19pF	p105
0.62pF	p101	5.5pF	p103	20pF	p105
0.68pF	p101	5.6pF	p103	22pF	p105
0.70pF	p101	5.7pF	p103	24pF	p105
0.75pF	p101	5.8pF	p103	27pF	p105
0.80pF	p101	5.9pF	p103	30pF	p105
0.82pF	p101	6.0pF	p103	33pF	p105
0.85pF	p101	6.1pF	p103	36pF	p105
0.90pF	p101	6.2pF	p103	39pF	p105
0.91pF	p101	6.3pF	p103	43pF	p105
0.95pF	p101	6.4pF	p103	47pF	p105
1.0pF	p101	6.5pF	p103		
1.1pF	p101	6.6pF	p103		
1.2pF	p101	6.7pF	p104		
1.3pF	p102	6.8pF	p104		
1.4pF	p102	6.9pF	p104		
1.5pF	p102	7.0pF	p104		
1.6pF	p102	7.1pF	p104		
1.7pF	p102	7.2pF	p104		
1.8pF	p102	7.3pF	p104		
1.9pF	p102	7.4pF	p104		
2.0pF	p102	7.5pF	p104		
2.1pF	p102	7.6pF	p104		
2.2pF	p102	7.7pF	p104		
2.3pF	p102	7.8pF	p104		
2.4pF	p102	7.9pF	p104		
2.5pF	p102	8.0pF	p104		
2.6pF	p102	8.1pF	p104		
2.7pF	p102	8.2pF	p104		
2.8pF	p102	8.3pF	p104		
2.9pF	p102	8.4pF	p104		
3.0pF	p102	8.5pF	p104		

GCD Series High Dielectric Constant Type

p00 ← Part Number List

EIA: **X7S X7R**

L×W (mm)	1.6×0.8			2.0×1.25		
T max. (mm)	0.9			1.4		
Rated Voltage (Vdc)	100	50	25	100	50	16
Cap. / TC Code	X7R	X7R	X7R	X7R	X7R	X7S
1000pF	p107	p107				
1200pF	p107	p107				
1500pF	p107	p107				
1800pF	p107	p107				
2200pF	p107	p107				
2700pF	p107	p107				
3300pF	p107	p107				
3900pF	p107	p107				
4700pF	p107	p107				
5600pF	p107	p107				
6800pF	p107	p107				
8200pF	p107	p107				
10000pF	p107	p107				
12000pF	p107	p107				
15000pF	p107	p107				
18000pF	p107	p107				
22000pF	p107	p107				
27000pF			p107	p107	p107	
33000pF			p107	p107	p107	
39000pF			p107	p107	p107	
47000pF			p107	p107	p107	
56000pF				p107	p107	
68000pF				p107	p108	
82000pF				p107	p108	
0.10μF				p107	p108	
0.47μF						p108

Capacitance Table

GCE Series High Dielectric Constant Type

p00 ← Part Number List EIA: X7R

L×W (mm)	1.6×0.8			2.0×1.25		
	T max. (mm)					
T max. (mm)		0.9			1.45	
Rated Voltage (Vdc)		100	50	25	100	50
Cap. / TC Code		X7R	X7R	X7R	X7R	X7R
1000pF	p110	p110				
1200pF	p110	p110				
1500pF	p110	p110				
1800pF	p110	p110				
2200pF	p110	p110				
2700pF	p110	p110				
3300pF	p110	p110				
3900pF	p110	p110				
4700pF	p110	p110				
5600pF	p110	p110				
6800pF	p110	p110				
8200pF	p110	p110				
10000pF	p110	p110				
12000pF	p110	p110				
15000pF	p110	p110				
18000pF	p110	p110				
22000pF	p110	p110				
27000pF			p110	p110	p110	
33000pF			p110	p110	p110	
39000pF			p110	p110	p110	
47000pF			p110	p110	p110	
56000pF				p110	p110	
68000pF				p110	p111	
82000pF				p110	p111	
0.10μF				p110	p111	

NFM Series

p00 ← Part Number List

L×W (mm)	1.6×0.8		2.0×1.25		3.2×1.6			
	T max. (mm)							
T max. (mm)		0.7		0.95		1.5		
Rated Voltage (Vdc)		16	6.3	50	16	10	100	50
Cap. / TC Code		-	-	-	-	-	-	-
220pF				p114				
470pF				p114				
1000pF				p114				
2200pF				p114				
10000pF						p114	p114	
15000pF							p114	
22000pF				p114			p114	
0.10μF						p114	p114	
0.22μF						p114		
0.47μF						p114		
1.0μF	p114	p114		p114				

KCM Series Temperature Compensating Type

p00 ← Part Number List EIA: COG U2J

L×W (mm)	6.1×5.1								
	T max. (mm)								
T max. (mm)		3.1		3.9		5.1		6.6	
Rated Voltage (Vdc)		1000	630	630	1000	630	630	1000	630
Cap. / TC Code		U2J	COG	U2J	COG	U2J	COG	U2J	COG
8200pF	p117								
10000pF	p117								
0.015μF		p117							
0.016μF						p117			
0.018μF		p117							
0.020μF						p117			
0.022μF						p117			
0.027μF						p117			
0.030μF							p117		
33000pF			p117						
0.036μF							p117		
39000pF			p117						
0.044μF									p117
47000pF			p117						
0.054μF									p117
66000pF								p117	
78000pF								p117	
94000pF								p117	

KCM Series High Dielectric Constant Type

p00 ← Part Number List EIA: X7S X7R

L×W (mm)	6.1×5.3																						
	3.0						3.9						5.0				6.7						
T max. (mm)		3.0						3.9						5.0				6.7					
Rated Voltage (Vdc)		100	63	50	35	25	100	63	50	35	25	100	50	35	25	100	63	50	35	25			
Cap. / TC Code		X7R	X7R	X7R	X7R	X7R	X7R	X7R	X7R	X7R	X7S	X7R	X7R	X7R	X7R	X7R	X7R	X7R	X7R	X7R	X7S		
4.7μF	p118	p118	p118																				
6.8μF						p118																	
10μF			p118	p118		p118	p118	p118				p118											
15μF				p118	p118											p118							
17μF								p118	p118														
22μF									p118	p118			p118	p118		p118	p118	p118					
33μF										p118				p118	p118			p118	p118				
47μF											p118								p118	p118			
68μF																				p118			
100μF																					p118		

Capacitance Table

KC3 Series High Dielectric Constant Type

p00 ← Part Number List EIA: X7T

L×W (mm)	6.1×5.3											
	3.0			3.9			5.0			6.7		
T max. (mm)	3.0	4.5	2.5	3.0	4.5	2.5	3.0	4.5	2.5	3.0	4.5	2.5
Rated Voltage (Vdc)	630	450	250	630	450	250	630	450	250	630	450	250
Cap. / TC Code	X7T	X7T	X7T	X7T	X7T	X7T	X7T	X7T	X7T	X7T	X7T	X7T
0.10μF	p121											
0.15μF	p121											
0.22μF		p121		p121								
0.27μF				p121								
0.33μF	p121	p121										
0.47μF	p121	p121	p121							p121		
0.56μF				p121	p121					p121		
0.68μF		p121	p121				p121	p121				
1.0μF				p121	p121	p121	p121					
1.2μF										p121	p121	
1.5μF								p121	p121			
2.2μF										p121	p121	

KCA Series Temperature Compensating Type

p00 ← Part Number List EIA: U2J

L×W (mm)	6.1×5.1			
	3.0	3.9	5.0	6.7
T max. (mm)	3.0	4.5	2.5	2.5
Rated Voltage (Vac (r.m.s.))	250	250	250	250
Cap. / TC Code	U2J	U2J	U2J	U2J
100pF	p124			
150pF	p124			
220pF	p124			
330pF	p124			
470pF	p124			
680pF	p124			
1000pF	p124			
1500pF	p124			
2200pF	p124			
3300pF	p124			
4700pF		p124		
6800pF			p124	
10000pF				p124

GCB Series High Dielectric Constant Type

p00 ← Part Number List EIA: X8R

L×W (mm)	1.0×0.5			
	0.55			
T max. (mm)	1.0	0.5	0.25	0.16
Rated Voltage (Vdc)	100	50	25	16
Cap. / TC Code	X8R	X8R	X8R	X8R
1000pF	p126	p126		
1500pF	p126	p126		
2200pF	p126	p126		
3300pF	p126	p126		
4700pF	p126	p126		
6800pF	p126		p126	
10000pF	p126		p126	
15000pF		p126		p126
22000pF		p126		p126
33000pF		p126		p126
47000pF		p126	p126	p126
68000pF			p126	p126
0.10μF			p126	p126

Capacitance Table

GCG Series Temperature Compensating Type

p00 ← Part Number List JIS: CH CJ CK EIA: C0G U2J Murata Temperature Characteristic: CHA X8G

L×W (mm)	1.0×0.5					1.6×0.8			2.0×1.25	
T max. (mm)	0.55					0.9			0.7	0.95
Rated Voltage (Vdc)	50					100	50	50	50	
Cap. / TC Code	COG	CH	CJ	CK	CHA	X8G	U2J	X8G	X8G	X8G
1.0pF	p128	p130		p133	p133	p136				
1.1pF	p128	p130		p133	p133	p136				
1.2pF	p128	p130		p133	p133	p136				
1.3pF	p128	p130		p133	p133	p136				
1.4pF	p128	p130		p133	p134	p136				
1.5pF	p128	p130		p133	p134	p137				
1.6pF	p128	p130		p133	p134	p137				
1.7pF	p128	p130		p133	p134	p137				
1.8pF	p128	p130		p133	p134	p137				
1.9pF	p128	p130		p133	p134	p137				
2.0pF	p128	p130		p133	p134	p137				
2.1pF	p128	p130	p133		p134	p137				
2.2pF	p128	p130	p133		p134	p137				
2.3pF	p128	p130	p133		p134	p137				
2.4pF	p128	p130	p133		p134	p137				
2.5pF	p128	p130	p133		p134	p137				
2.6pF	p128	p130	p133		p134	p137				
2.7pF	p128	p131	p133		p134	p137				
2.8pF	p128	p131	p133		p134	p137				
2.9pF	p128	p131	p133		p134	p137				
3.0pF	p128	p131	p133		p134	p137				
3.1pF	p128	p131	p133		p134	p137				
3.2pF	p128	p131	p133		p134	p137				
3.3pF	p128	p131	p133		p134	p137				
3.4pF	p128	p131	p133		p134	p137				
3.5pF	p128	p131	p133		p134	p137				
3.6pF	p128	p131	p133		p134	p137				
3.7pF	p128	p131	p133		p134	p137				
3.8pF	p128	p131	p133		p134	p137				
3.9pF	p128	p131	p133		p134	p137				
4.0pF	p128	p131			p134	p137				
4.1pF	p128	p131			p134	p137				
4.2pF	p128	p131			p134	p137				
4.3pF	p128	p131			p134	p137				
4.4pF	p128	p131			p134	p137				
4.5pF	p128	p131			p134	p137				
4.6pF	p129	p131			p134	p137				
4.7pF	p129	p131			p134	p137				
4.8pF	p129	p131			p134	p137				
4.9pF	p129	p131			p134	p137				
5.0pF	p129	p131			p135	p137				
5.1pF	p129	p131			p135	p138				
5.2pF	p129	p131			p135	p138				
5.3pF	p129	p131			p135	p138				
5.4pF	p129	p131			p135	p138				
5.5pF	p129	p131			p135	p138				
5.6pF	p129	p131			p135	p138				
5.7pF	p129	p131			p135	p138				
5.8pF	p129	p131			p135	p138				
5.9pF	p129	p131			p135	p138				
6.0pF	p129	p131			p135	p138				
6.1pF	p129	p131			p135	p138				
6.2pF	p129	p131			p135	p138				
6.3pF	p129	p132			p135	p138				
6.4pF	p129	p132			p135	p138				

↓ Continued on the following page.

Capacitance Table

(→ GCG Series Temperature Compensating Type)

p00 ← Part Number List JIS: CH CJ CK EIA: C0G U2J Murata Temperature Characteristic: CHA X8G

L×W (mm)	1.0×0.5					1.6×0.8			2.0×1.25	
T max. (mm)	0.55					0.9			0.7	0.95
Rated Voltage (Vdc)	50					100	50	50	50	
Cap. / TC Code	COG	CH	CJ	CK	CHA	X8G	U2J	X8G	X8G	X8G
6.5pF	p129	p132			p135	p138				
6.6pF	p129	p132			p135	p138				
6.7pF	p129	p132			p135	p138				
6.8pF	p129	p132			p135	p138				
6.9pF	p129	p132			p135	p138				
7.0pF	p129	p132			p135	p138				
7.1pF	p129	p132			p135	p138				
7.2pF	p129	p132			p135	p138				
7.3pF	p129	p132			p135	p138				
7.4pF	p129	p132			p135	p138				
7.5pF	p129	p132			p135	p138				
7.6pF	p129	p132			p135	p138				
7.7pF	p129	p132			p135	p138				
7.8pF	p129	p132			p135	p138				
7.9pF	p129	p132			p135	p138				
8.0pF	p129	p132			p135	p138				
8.1pF	p129	p132			p135	p138				
8.2pF	p130	p132			p135	p138				
8.3pF	p130	p132			p135	p138				
8.4pF	p130	p132			p135	p138				
8.5pF	p130	p132			p135	p138				
8.6pF	p130	p132			p136	p138				
8.7pF	p130	p132			p136	p139				
8.8pF	p130	p132			p136	p139				
8.9pF	p130	p132			p136	p139				
9.0pF	p130	p132			p136	p139				
9.1pF	p130	p132			p136	p139				
9.2pF	p130	p132			p136	p139				
9.3pF	p130	p132			p136	p139				
9.4pF	p130	p132			p136	p139				
9.5pF	p130	p132			p136	p139				
9.6pF	p130	p132			p136	p139				
9.7pF	p130	p132			p136	p139				
9.8pF	p130	p132			p136	p139				
9.9pF	p130	p133			p136	p139				
10pF	p130	p133			p136	p139	p140	p141		
11pF					p136	p139	p140			
12pF					p136	p139	p140	p141		
13pF					p136	p139	p140			
15pF					p136	p139	p140	p141		
16pF					p136	p139	p140			
18pF					p136	p139	p140	p141		
20pF					p136	p139	p140			
22pF					p136	p139	p140	p141		
24pF					p136	p139	p140			
27pF					p136	p139	p140	p141		
30pF					p136	p139	p140			
33pF					p136	p139	p140	p141		
36pF					p136	p139	p140			
39pF					p136	p139	p140	p141		
43pF					p136	p139	p140			
47pF					p136	p139	p140	p141		
51pF					p136	p139	p140			
56pF					p136	p139	p140	p141		
62pF					p136	p139	p140			

↓ Continued on the following page.

Capacitance Table

(→ GCG Series Temperature Compensating Type)

p00 ← Part Number List JIS: CH CJ CK EIA: COG U2J Murata Temperature Characteristic: CHA X8G

L×W (mm)	1.0×0.5					1.6×0.8			2.0×1.25	
T max. (mm)	0.55					0.9			0.7	0.95
Rated Voltage (Vdc)	50					100	50	50	50	
Cap. / TC Code	COG	CH	CJ	CK	CHA	X8G	U2J	X8G	X8G	X8G
68pF					p136	p139		p140	p141	
75pF					p136	p139		p141		
82pF					p136	p139		p141	p142	
91pF					p136	p139		p141		
100pF					p136	p139		p141	p142	
110pF						p139		p141		
120pF						p139		p141	p142	
130pF						p139		p141		
150pF						p139		p141	p142	
160pF						p139		p141		
180pF						p139		p141	p142	
200pF						p139		p141		
220pF						p139		p141	p142	
240pF						p140		p141		
270pF						p140		p141	p142	
300pF						p140		p141		
330pF						p140		p141	p142	
360pF						p140		p141		
390pF						p140		p141	p142	
430pF						p140		p141		
470pF						p140		p141	p142	
510pF								p141		
560pF								p141	p142	
620pF								p141		
680pF								p141	p142	
750pF								p141		
820pF								p141	p142	
910pF								p141		
1000pF							p140	p141	p142	p142
1100pF							p140			
1200pF							p140		p142	p142
1300pF							p140			
1500pF							p140		p142	p142
1600pF							p140			
1800pF							p140		p142	p142
2000pF							p140			
2200pF							p140		p142	p142
2400pF							p140			
2700pF							p140			p142
3000pF							p140			
3300pF							p140			p142
3600pF							p140			
3900pF							p140			p142
4300pF							p140			
4700pF							p140			p142
5100pF							p140			
5600pF							p140			p142
6200pF							p140			
6800pF							p140			p142
7500pF							p140			
8200pF							p140			p142
9100pF							p140			
10000pF							p140			p142

Capacitance Table

GCG Series High Dielectric Constant Type

p00 ← Part Number List EIA: X7S X7R X8R Murata Temperature Characteristic: X8L

L×W (mm)	1.0×0.5						1.6×0.8						2.0×1.25															
T max. (mm)	0.55						0.9						1.45															
Rated Voltage (Vdc)	50		25		16		100		50		25		16		10		6.3		50		35		25		16		10	
Cap. / TC Code	X8L	X7R	X8L	X7R	X8L	X7R	X8R	X8L	X8R	X7R	X8R	X7R	X8L	X7R	X7S	X7R	X8L	X7R	X8L	X7R	X8L	X8R	X7R	X8L	X7R	X7R	X7R	
220pF	p143	p143																										
270pF	p143	p143																										
330pF	p143	p143																										
390pF	p143	p143																										
470pF	p143	p143																										
560pF	p143	p143																										
680pF	p143	p143																										
820pF	p143	p143																										
1000pF	p143	p143						p144		p144																		
1200pF	p143	p143						p144		p144																		
1500pF	p143	p143						p144		p144																		
1800pF	p143	p143						p144		p144																		
2200pF	p143	p143						p144		p144																		
2700pF	p143	p143						p144		p144																		
3300pF	p143	p143						p144		p144																		
3900pF	p143	p143						p144		p144																		
4700pF	p143	p143						p144		p144																		
5600pF		p143	p143					p144		p144																		
6800pF		p143	p143					p144		p144																		
8200pF		p143	p143					p144		p144																		
10000pF		p143	p143					p144		p144																		
12000pF								p144																				
15000pF					p143	p143		p144		p144																		
18000pF					p143	p143		p144																				
22000pF					p143	p143		p144		p144																		
27000pF					p143	p143		p144																				
33000pF					p143	p143		p144		p144																		
39000pF					p143	p143		p144																				
47000pF					p143	p143		p144		p144																		
56000pF						p143		p144																				
68000pF						p143		p144																				
82000pF						p143																						
0.10μF						p143		p144		p144																		
0.12μF								p144				p144																
0.15μF								p144	p144	p144		p145	p145					p145										
0.18μF								p144				p145						p145										
0.22μF								p144	p144	p144		p145	p145					p145										
0.27μF																											p145	
0.33μF											p144							p145			p145					p145	p145	
0.39μF											p144															p145	p145	
0.47μF											p144							p145								p145	p145	
0.56μF																										p145	p145	
0.68μF																					p145	p145			p145	p145	p145	
0.82μF																					p145	p145			p145	p145	p145	
1.0μF												p145	p145					p145	p145	p145	p145			p145	p145			
1.2μF																												
1.5μF																												
2.2μF																												
3.3μF																												
3.9μF																												
4.7μF																												p145
6.8μF																												
10μF																												p145
22μF																												
47μF																												

Continued on the following page. ↗

Capacitance Table

(→ GCG Series High Dielectric Constant Type)

p00 ← Part Number List EIA: X7S X7R X8R Murata Temperature Characteristic: X8L

L×W (mm)	2.0×1.25				3.2×1.6						3.2×2.5								
T max. (mm)	1.45		1.35		1.9						2.8								
Rated Voltage (Vdc)	6.3		50	25	16	25	16	6.3	50	35	25	16	6.3						
Cap. / TC Code	X8L	X7R	X8R	X7R	X8L	X8R	X7R	X8L	X8R	X7R	X8L	X7S	X8L	X7S	X8L	X7R	X7S	X8R	X7R
220pF																			
270pF																			
330pF																			
390pF																			
470pF																			
560pF																			
680pF																			
820pF																			
1000pF																			
1200pF																			
1500pF																			
1800pF																			
2200pF																			
2700pF																			
3300pF																			
3900pF																			
4700pF																			
5600pF																			
6800pF																			
8200pF																			
10000pF																			
12000pF																			
15000pF																			
18000pF																			
22000pF																			
27000pF																			
33000pF																			
39000pF																			
47000pF																			
56000pF																			
68000pF																			
82000pF																			
0.10μF																			
0.12μF																			
0.15μF																			
0.18μF																			
0.22μF			p145																
0.27μF																			
0.33μF			p145																
0.39μF																			
0.47μF																			
0.56μF																			
0.68μF													p146						
0.82μF																			
1.0μF					p146	p146							p146						
1.2μF					p145														
1.5μF					p146	p146													
2.2μF					p146														
3.3μF													p146	p146					
3.9μF													p146						
4.7μF													p146	p146					
6.8μF																			p146
10μF	p145	p145											p146	p146	p146	p146		p146	p146
22μF																		p146	
47μF																			p146

Search Capacitors

Specifications and Test Methods, Package, Chart of Characteristic Data, please refer to the search web page.
<https://www.murata.com/en-global/products/capacitor>

Links are provided to the product detail pages on the web, and are shown below in the product number table from the PDF version of the catalog which is available on the web.

GRM Series Temperature Compensating

0.25×0.125mm

T max.	Rated Voltage	TC Code	Cap.	Tol.	Part Number
0.138mm	25Vdc	COG	0.20pF	±0.1pF	GRM015C1ER20BE11#
			0.30pF	±0.1pF	GRM015C1ER30BE11#
			0.40pF	±0.1pF	GRM015C1ER40BE11#
			0.50pF	±0.1pF	GRM015C1ER50BE11#
			0.60pF	±0.1pF	GRM015C1ER60BE11#
			0.70pF	±0.1pF	GRM015C1ER70BE11#
			0.80pF	±0.1pF	GRM015C1ER80BE11#
			0.90pF	±0.1pF	GRM015C1ER90BE11#

The screenshot shows a detailed product page for a capacitor. Key sections include:

- Appearance & Shape:** Shows a 3D model and a photograph of the capacitor component.
- Specifications:** Lists technical details such as capacitance, tolerance, and temperature characteristics.
- References:** Provides links to related documents and standards.
- Characteristic Data:** Contains several graphs showing the capacitor's performance under various conditions, such as frequency response and temperature stability.

Status and Features Icons

The status and features of products can be checked at once. When ? is clicked, a description of each icon will be displayed

Stock Check (Where to buy)

Some products can request free samples. Reference inventory information from agents and web-based companies.

Data Sheet

The product details page can be output in PDF.

How to read part numbers

Describes the meaning of the part number

Series Information

This links to the introduction page of each series.

Detailed Specifications Sheet

- Rated value
- Specifications and Test Methods
- Package
- Caution, Notice (Storage, Soldering and Mounting,etc.)

Characteristics Data

The following characteristics data of the main products can be acquired.

- SPICE Netlist (mod type)
- S parameter (S2P type)
- Reliability Test Data *Typical data

- Shape (Dimensions)
- Rated Values

- Specification by Packaging Code/ Minimum Order Quantity
- Weight (1 pc/ø180mm reel)

Chart of Characteristic Data

The main products published characteristic data.

- Frequency characteristics (ESR, Impedance)
- DC bias characteristics
- AC voltage characteristics
- Capacitance - temperature characteristics
- Calorific property by ripple current

AEC-Q200 Compliant Chip Multilayer Ceramic Capacitors for Infotainment

GRT Series



AEC-Q200 compliant capacitor (Grade2 or Grade3).

Features

① **This product has cleared AEC-Q200 compliant test conditions.**

This series is designed for use in Car Multimedia, Car Interior, Car Comfort application and General Electronic equipment. It is not appropriate for use in applications critical to passenger safety and car driving function (e.g. ABS, AIRBAG, etc.). Please use the GCM series is in critical applications.

	General Purpose GRM Series Maximum operating temperature: 125°C	AEC-Q200 compliant GRT Series Maximum operating temperature: 125°C
Items	Test Method	Test Method
Temperature Cycle	Temperature Cycle: 5 cycles	Temperature Cycle: 1,000 cycles
Humidity Loading	Test temperature: 40±2°C Test humidity: 90 to 95%RH Test time: 500 hours	Test temperature: 85±2°C Test humidity: 80 to 85%RH Test time: 1,000 hours

② **AEC-Q200 compliant (Grade2 or Grade3)**

105°C product: Grade2.
 85°C product: Grade3.

③ **Sn plating is applied to the external electrodes; excellent solderability.**

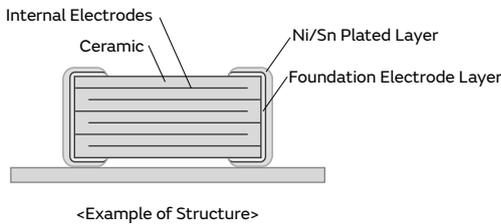

Specifications

Size	0.6×0.3mm to 3.2×2.5mm
Rated Voltage	2.5Vdc to 100Vdc
Capacitance	0.10pF to 100μF
Main Applications	Such as Information and Comfort equipment, car navigation, communication module and entertainment system

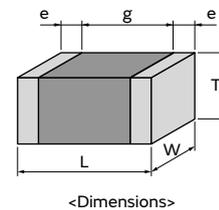

GRT Series

GCM Series

GC3 Series

GCJ Series

GCQ Series

GCD Series

GCE Series

NMF Series

KCM Series

KC3 Series

KCA Series

GCB Series

GCG Series

△Caution /Notice

GRT Series Temperature Compensating Type Part Number List

0.6×0.3mm

T max.	Rated Voltage	TC Code	Cap.	Tol.	Part Number	
0.33mm	100Vdc	COG	0.10pF	±0.05pF	GRT0335C2AR10WA02#	D1
				±0.1pF	GRT0335C2AR20BA02#	D1
			0.20pF	±0.05pF	GRT0335C2AR20WA02#	D1
				±0.1pF	GRT0335C2AR30BA02#	D1
			0.30pF	±0.05pF	GRT0335C2AR30WA02#	D1
				±0.1pF	GRT0335C2AR30BA02#	D1
			1.0pF	±0.25pF	GRT0335C2A1R0CA02#	D1
			1.1pF	±0.25pF	GRT0335C2A1R1CA02#	D1
			1.2pF	±0.25pF	GRT0335C2A1R2CA02#	D1
			1.3pF	±0.25pF	GRT0335C2A1R3CA02#	D1
			1.5pF	±0.25pF	GRT0335C2A1R5CA02#	D1
			1.6pF	±0.25pF	GRT0335C2A1R6CA02#	D1
			1.8pF	±0.25pF	GRT0335C2A1R8CA02#	D1
			2.0pF	±0.25pF	GRT0335C2A2R0CA02#	D1
			2.2pF	±0.25pF	GRT0335C2A2R2CA02#	D1
			2.4pF	±0.25pF	GRT0335C2A2R4CA02#	D1
			2.7pF	±0.25pF	GRT0335C2A2R7CA02#	D1
			3.0pF	±0.25pF	GRT0335C2A3R0CA02#	D1
			3.3pF	±0.25pF	GRT0335C2A3R3CA02#	D1
			3.6pF	±0.25pF	GRT0335C2A3R6CA02#	D1
			3.9pF	±0.25pF	GRT0335C2A3R9CA02#	D1
			4.0pF	±0.25pF	GRT0335C2A4R0CA02#	D1
			4.3pF	±0.25pF	GRT0335C2A4R3CA02#	D1
			4.7pF	±0.25pF	GRT0335C2A4R7CA02#	D1
			5.0pF	±0.25pF	GRT0335C2A5R0CA02#	D1
			5.1pF	±0.5pF	GRT0335C2A5R1DA02#	D1
			5.6pF	±0.5pF	GRT0335C2A5R6DA02#	D1
			6.0pF	±0.5pF	GRT0335C2A6R0DA02#	D1
			6.2pF	±0.5pF	GRT0335C2A6R2DA02#	D1
			6.8pF	±0.5pF	GRT0335C2A6R8DA02#	D1
			7.0pF	±0.5pF	GRT0335C2A7R0DA02#	D1
			7.5pF	±0.5pF	GRT0335C2A7R5DA02#	D1
			8.0pF	±0.5pF	GRT0335C2A8R0DA02#	D1
			8.2pF	±0.5pF	GRT0335C2A8R2DA02#	D1
			9.0pF	±0.5pF	GRT0335C2A9R0DA02#	D1
			9.1pF	±0.5pF	GRT0335C2A9R1DA02#	D1
			10pF	±1%	GRT0335C2A100FA02#	D1
				±2%	GRT0335C2A100GA02#	D1
				±5%	GRT0335C2A100JA02#	D1
			11pF	±2%	GRT0335C2A110GA02#	D1
				±5%	GRT0335C2A110JA02#	D1
			12pF	±1%	GRT0335C2A120FA02#	D1
				±2%	GRT0335C2A120GA02#	D1
				±5%	GRT0335C2A120JA02#	D1
			13pF	±2%	GRT0335C2A130GA02#	D1
				±5%	GRT0335C2A130JA02#	D1
			15pF	±1%	GRT0335C2A150FA02#	D1
				±2%	GRT0335C2A150GA02#	D1
				±5%	GRT0335C2A150JA02#	D1
			16pF	±2%	GRT0335C2A160GA02#	D1
				±5%	GRT0335C2A160JA02#	D1
			18pF	±1%	GRT0335C2A180FA02#	D1
±2%	GRT0335C2A180GA02#	D1				

T max.	Rated Voltage	TC Code	Cap.	Tol.	Part Number	
0.33mm	100Vdc	COG	18pF	±5%	GRT0335C2A180JA02#	D1
				±1%	GRT0335C2A200FA02#	D1
					±2%	GRT0335C2A200GA02#
			20pF	±5%	GRT0335C2A200JA02#	D1
				±1%	GRT0335C2A220FA02#	D1
					±2%	GRT0335C2A220GA02#
			22pF	±5%	GRT0335C2A220JA02#	D1
				±1%	GRT0335C2A240FA02#	D1
					±2%	GRT0335C2A240GA02#
			24pF	±5%	GRT0335C2A240JA02#	D1
				±1%	GRT0335C2A270FA02#	D1
					±2%	GRT0335C2A270GA02#
			27pF	±5%	GRT0335C2A270JA02#	D1
				±1%	GRT0335C2A300FA02#	D1
					±2%	GRT0335C2A300GA02#
			30pF	±5%	GRT0335C2A300JA02#	D1
				±1%	GRT0335C2A330FA02#	D1
					±2%	GRT0335C2A330GA02#
			33pF	±5%	GRT0335C2A330JA02#	D1
				±1%	GRT0335C2A360FA02#	D1
					±2%	GRT0335C2A360GA02#
			36pF	±5%	GRT0335C2A360JA02#	D1
				±1%	GRT0335C2A390FA02#	D1
					±2%	GRT0335C2A390GA02#
			39pF	±5%	GRT0335C2A390JA02#	D1
				±1%	GRT0335C2A430FA02#	D1
					±2%	GRT0335C2A430GA02#
			43pF	±5%	GRT0335C2A430JA02#	D1
				±1%	GRT0335C2A470FA02#	D1
					±2%	GRT0335C2A470GA02#
			47pF	±5%	GRT0335C2A470JA02#	D1
				±1%	GRT0335C2A510FA02#	D1
					±2%	GRT0335C2A510GA02#
			51pF	±5%	GRT0335C2A510JA02#	D1
				±1%	GRT0335C2A560FA02#	D1
					±2%	GRT0335C2A560GA02#
			56pF	±5%	GRT0335C2A560JA02#	D1
				±1%	GRT0335C2A620FA02#	D1
					±2%	GRT0335C2A620GA02#
			62pF	±5%	GRT0335C2A620JA02#	D1
				±1%	GRT0335C2A680FA02#	D1
					±2%	GRT0335C2A680GA02#
			68pF	±5%	GRT0335C2A680JA02#	D1
				±1%	GRT0335C2A750FA02#	D1
					±2%	GRT0335C2A750GA02#
			75pF	±5%	GRT0335C2A750JA02#	D1
				±1%	GRT0335C2A820FA02#	D1
					±2%	GRT0335C2A820GA02#
			82pF	±5%	GRT0335C2A820JA02#	D1
				±1%	GRT0335C2A910FA02#	D1
					±2%	GRT0335C2A910GA02#
			91pF	±5%	GRT0335C2A910JA02#	D1
±1%	GRT0335C2A101FA02#	D1				
	±2%	GRT0335C2A101GA02#		D1		
100pF	±1%	GRT0335C2A101JA02#	D1			
	±2%	GRT0335C2A101GA02#	D1			

Part number # indicates the package specification code.

GRT Series
 GCM Series
 GC3 Series
 GCJ Series
 GCQ Series
 GCD Series
 GCE Series
 NMF Series
 KCM Series
 KC3 Series
 KCA Series
 GCB Series
 GCG Series
 ⚠Caution /Notice

GRT Series Temperature Compensating Type Part Number List

(→ 0.6×0.3mm)

T max.	Rated Voltage	TC Code	Cap.	Tol.	Part Number		T max.	Rated Voltage	TC Code	Cap.	Tol.	Part Number	
0.33mm	100Vdc	COG	100pF	±5%	GRT0335C2A101JA02#	D1	0.33mm	50Vdc	COG	12pF	±5%	GRT0335C1H120JA02#	D1
	50Vdc	COG	0.10pF	±0.05pF	GRT0335C1HR10WA02#	D1				13pF	±1%	GRT0335C1H130FA02#	D1
				±0.05pF	GRT0335C1HR20WA02#	D1					±2%	GRT0335C1H130GA02#	D1
			±0.1pF	GRT0335C1HR20BA02#	D1	±5%					GRT0335C1H130JA02#	D1	
				0.30pF	±0.05pF	GRT0335C1HR30WA02#				D1	15pF	±1%	GRT0335C1H150FA02#
			±0.1pF		GRT0335C1HR30BA02#	D1				±2%		GRT0335C1H150GA02#	D1
			±0.05pF		GRT0335C1HR47WA02#	D1				±5%		GRT0335C1H150JA02#	D1
			±0.1pF	GRT0335C1HR47BA02#	D1	16pF				±1%	GRT0335C1H160FA02#	D1	
				±0.05pF	GRT0335C1HR56WA02#					D1	±2%	GRT0335C1H160GA02#	D1
			±0.1pF	GRT0335C1HR56BA02#	D1					±5%	GRT0335C1H160JA02#	D1	
			0.68pF	±0.05pF	GRT0335C1HR68WA02#	D1				18pF	±1%	GRT0335C1H180FA02#	D1
				±0.1pF	GRT0335C1HR68BA02#	D1					±2%	GRT0335C1H180GA02#	D1
			±0.05pF	GRT0335C1HR75WA02#	D1	±5%					GRT0335C1H180JA02#	D1	
			±0.1pF	GRT0335C1HR75BA02#	D1	20pF				±1%	GRT0335C1H200FA02#	D1	
				±0.05pF	GRT0335C1HR82WA02#					D1	±2%	GRT0335C1H200GA02#	D1
			±0.1pF	GRT0335C1HR82BA02#	D1					±5%	GRT0335C1H200JA02#	D1	
			0.91pF	±0.05pF	GRT0335C1HR91WA02#	D1				22pF	±1%	GRT0335C1H220FA02#	D1
				±0.1pF	GRT0335C1HR91BA02#	D1					±2%	GRT0335C1H220GA02#	D1
			±0.25pF	GRT0335C1H1R0CA02#	D1	±5%					GRT0335C1H220JA02#	D1	
			±0.25pF	GRT0335C1H1R1CA02#	D1	24pF				±1%	GRT0335C1H240FA02#	D1	
			±0.25pF	GRT0335C1H1R2CA02#	D1					±2%	GRT0335C1H240GA02#	D1	
			±0.25pF	GRT0335C1H1R3CA02#	D1					±5%	GRT0335C1H240JA02#	D1	
			±0.25pF	GRT0335C1H1R5CA02#	D1	27pF				±1%	GRT0335C1H270FA02#	D1	
			±0.25pF	GRT0335C1H1R6CA02#	D1					±2%	GRT0335C1H270GA02#	D1	
			±0.25pF	GRT0335C1H1R8CA02#	D1					±5%	GRT0335C1H270JA02#	D1	
			±0.25pF	GRT0335C1H2R0CA02#	D1	30pF				±1%	GRT0335C1H300FA02#	D1	
			±0.25pF	GRT0335C1H2R2CA02#	D1					±2%	GRT0335C1H300GA02#	D1	
			±0.25pF	GRT0335C1H2R4CA02#	D1					±5%	GRT0335C1H300JA02#	D1	
			±0.25pF	GRT0335C1H2R7CA02#	D1	33pF				±1%	GRT0335C1H330FA02#	D1	
			±0.25pF	GRT0335C1H3R0CA02#	D1					±2%	GRT0335C1H330GA02#	D1	
			±0.25pF	GRT0335C1H3R3CA02#	D1					±5%	GRT0335C1H330JA02#	D1	
			±0.25pF	GRT0335C1H3R6CA02#	D1	36pF				±1%	GRT0335C1H360FA02#	D1	
			±0.25pF	GRT0335C1H3R9CA02#	D1					±2%	GRT0335C1H360GA02#	D1	
			±0.25pF	GRT0335C1H4R0CA02#	D1					±5%	GRT0335C1H360JA02#	D1	
			±0.25pF	GRT0335C1H4R3CA02#	D1	39pF				±1%	GRT0335C1H390FA02#	D1	
			±0.25pF	GRT0335C1H4R7CA02#	D1					±2%	GRT0335C1H390GA02#	D1	
			±0.25pF	GRT0335C1H5R0CA02#	D1					±5%	GRT0335C1H390JA02#	D1	
			±0.5pF	GRT0335C1H5R1DA02#	D1	43pF				±1%	GRT0335C1H430FA02#	D1	
			±0.5pF	GRT0335C1H5R6DA02#	D1					±2%	GRT0335C1H430GA02#	D1	
			±0.5pF	GRT0335C1H6R0DA02#	D1					±5%	GRT0335C1H430JA02#	D1	
			±0.5pF	GRT0335C1H6R2DA02#	D1	47pF				±1%	GRT0335C1H470FA02#	D1	
			±0.5pF	GRT0335C1H6R8DA02#	D1					±2%	GRT0335C1H470GA02#	D1	
			±0.5pF	GRT0335C1H7R0DA02#	D1					±5%	GRT0335C1H470JA02#	D1	
			±0.5pF	GRT0335C1H7R5DA02#	D1	51pF				±1%	GRT0335C1H510FA02#	D1	
			±0.5pF	GRT0335C1H8R0DA02#	D1					±2%	GRT0335C1H510GA02#	D1	
			±0.5pF	GRT0335C1H8R2DA02#	D1					±5%	GRT0335C1H510JA02#	D1	
			±0.5pF	GRT0335C1H9R0DA02#	D1	56pF				±1%	GRT0335C1H560FA02#	D1	
			±0.5pF	GRT0335C1H9R1DA02#	D1					±2%	GRT0335C1H560GA02#	D1	
			±5%	GRT0335C1H100JA02#	D1					±5%	GRT0335C1H560JA02#	D1	
	±1%	GRT0335C1H110FA02#	D1	62pF	±1%	GRT0335C1H620FA02#				D1			
		±2%	GRT0335C1H110GA02#		D1	±2%				GRT0335C1H620GA02#	D1		
		±5%	GRT0335C1H110JA02#		D1	±5%				GRT0335C1H620JA02#	D1		
±1%		GRT0335C1H120FA02#	D1		68pF	±1%	GRT0335C1H680FA02#	D1					
±2%	GRT0335C1H120GA02#	D1	±2%	GRT0335C1H680GA02#		D1							

Part number # indicates the package specification code.

GRT Series
 GCM Series
 GC3 Series
 GCJ Series
 GCQ Series
 GCD Series
 GCE Series
 NMF Series
 KCM Series
 KC3 Series
 KCA Series
 GCB Series
 GCG Series
 ⚠Caution /Notice

GRT Series Temperature Compensating Type Part Number List

(→ 0.6×0.3mm)

T max.	Rated Voltage	TC Code	Cap.	Tol.	Part Number		T max.	Rated Voltage	TC Code	Cap.	Tol.	Part Number			
0.33mm	50Vdc	COG	68pF	±5%	GRT0335C1H680JA02#	D1	0.33mm	25Vdc	COG	0.36pF	±0.1pF	GRT0335C1ER36BA02#	D1		
				75pF	±1%	GRT0335C1H750FA02#					D1	0.39pF	±0.05pF	GRT0335C1ER39WA02#	D1
					±2%	GRT0335C1H750GA02#					D1		±0.1pF	GRT0335C1ER39BA02#	D1
			±5%		GRT0335C1H750JA02#	D1				0.43pF	±0.05pF			GRT0335C1ER43WA02#	D1
			82pF	±1%	GRT0335C1H820FA02#	D1					±0.1pF	GRT0335C1ER43BA02#	D1		
				±2%	GRT0335C1H820GA02#	D1						±0.05pF	GRT0335C1ER47WA02#	D1	
				±5%	GRT0335C1H820JA02#	D1				0.47pF	±0.1pF		GRT0335C1ER47BA02#	D1	
			91pF	±1%	GRT0335C1H910FA02#	D1					±0.05pF	GRT0335C1ER51WA02#	D1		
				±2%	GRT0335C1H910GA02#	D1						±0.1pF	GRT0335C1ER51BA02#	D1	
				±5%	GRT0335C1H910JA02#	D1				0.51pF	±0.05pF		GRT0335C1ER51WA02#	D1	
			100pF	±1%	GRT0335C1H101FA02#	D1					±0.1pF	GRT0335C1ER56BA02#	D1		
				±2%	GRT0335C1H101GA02#	D1						±0.05pF	GRT0335C1ER62WA02#	D1	
				±5%	GRT0335C1H101JA02#	D1				0.62pF	±0.1pF		GRT0335C1ER62BA02#	D1	
			110pF	±1%	GRT0335C1H111FA02#	D1					±0.05pF	GRT0335C1ER68WA02#	D1		
				±2%	GRT0335C1H111GA02#	D1						±0.1pF	GRT0335C1ER68BA02#	D1	
				±5%	GRT0335C1H111JA02#	D1				0.68pF	±0.05pF		GRT0335C1ER75WA02#	D1	
			120pF	±1%	GRT0335C1H121FA02#	D1					±0.1pF	GRT0335C1ER75BA02#	D1		
				±2%	GRT0335C1H121GA02#	D1						±0.05pF	GRT0335C1ER82WA02#	D1	
				±5%	GRT0335C1H121JA02#	D1				0.82pF	±0.1pF		GRT0335C1ER82BA02#	D1	
			150pF	±1%	GRT0335C1H151FA02#	D1					±0.05pF	GRT0335C1ER91WA02#	D1		
				±2%	GRT0335C1H151GA02#	D1						±0.1pF	GRT0335C1ER91BA02#	D1	
				±5%	GRT0335C1H151JA02#	D1				1.0pF	±0.25pF		GRT0335C1E1R0CA02#	D1	
			180pF	±1%	GRT0335C1H181FA02#	D1					±0.25pF	GRT0335C1E1R1CA02#	D1		
				±2%	GRT0335C1H181GA02#	D1						±0.25pF	GRT0335C1E1R2CA02#	D1	
				±5%	GRT0335C1H181JA02#	D1				1.1pF	±0.25pF		GRT0335C1E1R3CA02#	D1	
			220pF	±1%	GRT0335C1H221FA02#	D1					±0.25pF	GRT0335C1E1R5CA02#	D1		
				±2%	GRT0335C1H221GA02#	D1						±0.25pF	GRT0335C1E1R6CA02#	D1	
				±5%	GRT0335C1H221JA02#	D1				1.3pF	±0.25pF		GRT0335C1E1R8CA02#	D1	
			0.10pF	±0.05pF	GRT0335C1ER10WA02#	D1					±0.25pF	GRT0335C1E2R0CA02#	D1		
				±0.05pF	GRT0335C1ER11WA02#	D1						±0.25pF	GRT0335C1E2R2CA02#	D1	
				±0.1pF	GRT0335C1ER11BA02#	D1				2.2pF	±0.25pF		GRT0335C1E2R4CA02#	D1	
			±0.05pF		GRT0335C1ER12WA02#	D1					±0.25pF	GRT0335C1E2R7CA02#	D1		
			±0.1pF	GRT0335C1ER12BA02#	D1	3.0pF						±0.25pF	GRT0335C1E3R0CA02#	D1	
				±0.05pF	GRT0335C1ER13WA02#					D1	±0.25pF	GRT0335C1E3R3CA02#	D1		
			±0.1pF	GRT0335C1ER13BA02#	D1					3.3pF		±0.25pF	GRT0335C1E3R6CA02#	D1	
				±0.05pF	GRT0335C1ER15WA02#	D1					±0.25pF	GRT0335C1E3R9CA02#	D1		
			±0.1pF	GRT0335C1ER15BA02#	D1	3.6pF						±0.25pF	GRT0335C1E4R0CA02#	D1	
				±0.05pF	GRT0335C1ER16WA02#					D1	±0.25pF	GRT0335C1E4R3CA02#	D1		
			±0.1pF	GRT0335C1ER16BA02#	D1					4.0pF		±0.25pF	GRT0335C1E4R7CA02#	D1	
				±0.05pF	GRT0335C1ER18WA02#	D1					±0.25pF	GRT0335C1E5R0CA02#	D1		
			±0.1pF	GRT0335C1ER18BA02#	D1	5.0pF						±0.5pF	GRT0335C1E5R1DA02#	D1	
				±0.05pF	GRT0335C1ER20WA02#					D1	±0.5pF	GRT0335C1E5R6DA02#	D1		
			±0.1pF	GRT0335C1ER20BA02#	D1					5.1pF		±0.5pF	GRT0335C1E6R0DA02#	D1	
				±0.05pF	GRT0335C1ER22WA02#	D1					±0.5pF	GRT0335C1E6R2DA02#	D1		
			±0.1pF	GRT0335C1ER22BA02#	D1	6.0pF						±0.5pF	GRT0335C1E6R8DA02#	D1	
				±0.05pF	GRT0335C1ER24WA02#					D1	±0.5pF	GRT0335C1E7R0DA02#	D1		
			±0.1pF	GRT0335C1ER24BA02#	D1					7.0pF		±0.5pF	GRT0335C1E7R5DA02#	D1	
				±0.05pF	GRT0335C1ER27WA02#	D1					±0.5pF	GRT0335C1E8R0DA02#	D1		
±0.1pF	GRT0335C1ER27BA02#	D1	8.0pF	±0.5pF	GRT0335C1E8R2DA02#	D1									
	±0.05pF	GRT0335C1ER30WA02#		D1	±0.5pF	GRT0335C1E9R0DA02#	D1								
±0.1pF	GRT0335C1ER30BA02#	D1		9.0pF		±0.5pF	GRT0335C1E9R1DA02#	D1							
	±0.05pF	GRT0335C1ER33WA02#	D1		±1%	GRT0335C1E100FA02#	D1								
±0.1pF	GRT0335C1ER33BA02#	D1	10pF			±2%	GRT0335C1E100GA02#	D1							
	±0.05pF	GRT0335C1ER36WA02#		D1	±5%	GRT0335C1E100JA02#	D1								

Part number # indicates the package specification code.

GRT Series
 GCM Series
 GC3 Series
 GCJ Series
 GCQ Series
 GCD Series
 GCE Series
 NMF Series
 KCM Series
 KC3 Series
 KCA Series
 GCB Series
 GCG Series
 △Caution /Notice

GRT Series Temperature Compensating Type Part Number List

(→ 0.6×0.3mm)

T max.	Rated Voltage	TC Code	Cap.	Tol.	Part Number	
0.33mm	25Vdc	COG	11pF	±1%	GRT0335C1E110FA02#	D1
				±2%	GRT0335C1E110GA02#	D1
				±5%	GRT0335C1E110JA02#	D1
			12pF	±1%	GRT0335C1E120FA02#	D1
				±2%	GRT0335C1E120GA02#	D1
				±5%	GRT0335C1E120JA02#	D1
			13pF	±1%	GRT0335C1E130FA02#	D1
				±2%	GRT0335C1E130GA02#	D1
				±5%	GRT0335C1E130JA02#	D1
			15pF	±1%	GRT0335C1E150FA02#	D1
				±2%	GRT0335C1E150GA02#	D1
				±5%	GRT0335C1E150JA02#	D1
			16pF	±1%	GRT0335C1E160FA02#	D1
				±2%	GRT0335C1E160GA02#	D1
				±5%	GRT0335C1E160JA02#	D1
			18pF	±1%	GRT0335C1E180FA02#	D1
				±2%	GRT0335C1E180GA02#	D1
				±5%	GRT0335C1E180JA02#	D1
			20pF	±1%	GRT0335C1E200FA02#	D1
				±2%	GRT0335C1E200GA02#	D1
				±5%	GRT0335C1E200JA02#	D1
			22pF	±1%	GRT0335C1E220FA02#	D1
				±2%	GRT0335C1E220GA02#	D1
				±5%	GRT0335C1E220JA02#	D1
			24pF	±1%	GRT0335C1E240FA02#	D1
				±2%	GRT0335C1E240GA02#	D1
				±5%	GRT0335C1E240JA02#	D1
			27pF	±1%	GRT0335C1E270FA02#	D1
				±2%	GRT0335C1E270GA02#	D1
				±5%	GRT0335C1E270JA02#	D1
			30pF	±1%	GRT0335C1E300FA02#	D1
				±2%	GRT0335C1E300GA02#	D1
				±5%	GRT0335C1E300JA02#	D1
			33pF	±1%	GRT0335C1E330FA02#	D1
				±2%	GRT0335C1E330GA02#	D1
				±5%	GRT0335C1E330JA02#	D1
			36pF	±1%	GRT0335C1E360FA02#	D1
				±2%	GRT0335C1E360GA02#	D1
				±5%	GRT0335C1E360JA02#	D1
			39pF	±1%	GRT0335C1E390FA02#	D1
				±2%	GRT0335C1E390GA02#	D1
				±5%	GRT0335C1E390JA02#	D1
			43pF	±1%	GRT0335C1E430FA02#	D1
				±2%	GRT0335C1E430GA02#	D1
				±5%	GRT0335C1E430JA02#	D1
			47pF	±1%	GRT0335C1E470FA02#	D1
				±2%	GRT0335C1E470GA02#	D1
				±5%	GRT0335C1E470JA02#	D1
			51pF	±1%	GRT0335C1E510FA02#	D1
				±2%	GRT0335C1E510GA02#	D1
				±5%	GRT0335C1E510JA02#	D1
			56pF	±1%	GRT0335C1E560FA02#	D1
				±2%	GRT0335C1E560GA02#	D1
				±5%	GRT0335C1E560JA02#	D1

T max.	Rated Voltage	TC Code	Cap.	Tol.	Part Number	
0.33mm	25Vdc	COG	62pF	±1%	GRT0335C1E620FA02#	D1
				±2%	GRT0335C1E620GA02#	D1
				±5%	GRT0335C1E620JA02#	D1
			68pF	±1%	GRT0335C1E680FA02#	D1
				±2%	GRT0335C1E680GA02#	D1
				±5%	GRT0335C1E680JA02#	D1
			75pF	±1%	GRT0335C1E750FA02#	D1
				±2%	GRT0335C1E750GA02#	D1
				±5%	GRT0335C1E750JA02#	D1
			82pF	±1%	GRT0335C1E820FA02#	D1
				±2%	GRT0335C1E820GA02#	D1
				±5%	GRT0335C1E820JA02#	D1
			91pF	±1%	GRT0335C1E910FA02#	D1
				±2%	GRT0335C1E910GA02#	D1
				±5%	GRT0335C1E910JA02#	D1
			100pF	±1%	GRT0335C1E101FA02#	D1
				±2%	GRT0335C1E101GA02#	D1
				±5%	GRT0335C1E101JA02#	D1
			110pF	±1%	GRT0335C1E111FA02#	D1
				±2%	GRT0335C1E111GA02#	D1
				±5%	GRT0335C1E111JA02#	D1
			150pF	±1%	GRT0335C1E151FA02#	D1
				±2%	GRT0335C1E151GA02#	D1
				±5%	GRT0335C1E151JA02#	D1
			180pF	±1%	GRT0335C1E181FA02#	D1
				±2%	GRT0335C1E181GA02#	D1
				±5%	GRT0335C1E181JA02#	D1
			220pF	±1%	GRT0335C1E221FA02#	D1
				±2%	GRT0335C1E221GA02#	D1
				±5%	GRT0335C1E221JA02#	D1
			270pF	±1%	GRT0335C1E271FA02#	D1
				±2%	GRT0335C1E271GA02#	D1
				±5%	GRT0335C1E271JA02#	D1
			330pF	±1%	GRT0335C1E331FA02#	D1
				±2%	GRT0335C1E331GA02#	D1
				±5%	GRT0335C1E331JA02#	D1
			390pF	±1%	GRT0335C1E391FA02#	D1
				±2%	GRT0335C1E391GA02#	D1
				±5%	GRT0335C1E391JA02#	D1
			470pF	±1%	GRT0335C1E471FA02#	D1
				±2%	GRT0335C1E471GA02#	D1
				±5%	GRT0335C1E471JA02#	D1
			560pF	±1%	GRT0335C1E561FA02#	D1
				±2%	GRT0335C1E561GA02#	D1
				±5%	GRT0335C1E561JA02#	D1
			680pF	±1%	GRT0335C1E681FA02#	D1
				±2%	GRT0335C1E681GA02#	D1
				±5%	GRT0335C1E681JA02#	D1
			820pF	±1%	GRT0335C1E821FA02#	D1
				±2%	GRT0335C1E821GA02#	D1
				±5%	GRT0335C1E821JA02#	D1
			910pF	±1%	GRT0335C1E911FA02#	D1
				±2%	GRT0335C1E911GA02#	D1
				±5%	GRT0335C1E911JA02#	D1

Part number # indicates the package specification code.

GRT Series Temperature Compensating Type Part Number List

(→ 0.6×0.3mm)

T max.	Rated Voltage	TC Code	Cap.	Tol.	Part Number	
0.33mm	25Vdc	COG	1000pF	±1%	GRT0335C1E102FA02#	D1
				±2%	GRT0335C1E102GA02#	D1
				±5%	GRT0335C1E102JA02#	D1

1.0×0.5mm

T max.	Rated Voltage	TC Code	Cap.	Tol.	Part Number				
0.55mm	100Vdc	COG	0.20pF	±0.1pF	GRT1555C2AR20BA02#	D1			
			0.30pF	±0.1pF	GRT1555C2AR30BA02#	D1			
			1.0pF	±0.25pF	GRT1555C2A1R0CA02#	D1			
			1.1pF	±0.25pF	GRT1555C2A1R1CA02#	D1			
			1.2pF	±0.25pF	GRT1555C2A1R2CA02#	D1			
			1.3pF	±0.25pF	GRT1555C2A1R3CA02#	D1			
			1.5pF	±0.25pF	GRT1555C2A1R5CA02#	D1			
			1.6pF	±0.25pF	GRT1555C2A1R6CA02#	D1			
			1.8pF	±0.25pF	GRT1555C2A1R8CA02#	D1			
			2.0pF	±0.25pF	GRT1555C2A2R0CA02#	D1			
			2.2pF	±0.25pF	GRT1555C2A2R2CA02#	D1			
			2.4pF	±0.25pF	GRT1555C2A2R4CA02#	D1			
			2.7pF	±0.25pF	GRT1555C2A2R7CA02#	D1			
			3.0pF	±0.25pF	GRT1555C2A3R0CA02#	D1			
			3.3pF	±0.25pF	GRT1555C2A3R3CA02#	D1			
			3.6pF	±0.25pF	GRT1555C2A3R6CA02#	D1			
			3.9pF	±0.25pF	GRT1555C2A3R9CA02#	D1			
			4.0pF	±0.25pF	GRT1555C2A4R0CA02#	D1			
			4.3pF	±0.25pF	GRT1555C2A4R3CA02#	D1			
			4.7pF	±0.25pF	GRT1555C2A4R7CA02#	D1			
			5.0pF	±0.25pF	GRT1555C2A5R0CA02#	D1			
			5.1pF	±0.5pF	GRT1555C2A5R1DA02#	D1			
			5.6pF	±0.5pF	GRT1555C2A5R6DA02#	D1			
			6.0pF	±0.5pF	GRT1555C2A6R0DA02#	D1			
			6.2pF	±0.5pF	GRT1555C2A6R2DA02#	D1			
			6.8pF	±0.5pF	GRT1555C2A6R8DA02#	D1			
			7.0pF	±0.5pF	GRT1555C2A7R0DA02#	D1			
			7.5pF	±0.5pF	GRT1555C2A7R5DA02#	D1			
			8.0pF	±0.5pF	GRT1555C2A8R0DA02#	D1			
			8.2pF	±0.5pF	GRT1555C2A8R2DA02#	D1			
			9.0pF	±0.5pF	GRT1555C2A9R0DA02#	D1			
			9.1pF	±0.5pF	GRT1555C2A9R1DA02#	D1			
			10pF	±5%	GRT1555C2A100JA02#	D1			
			12pF	±5%	GRT1555C2A120JA02#	D1			
			15pF	±5%	GRT1555C2A150JA02#	D1			
			18pF	±5%	GRT1555C2A180JA02#	D1			
			22pF	±5%	GRT1555C2A220JA02#	D1			
			27pF	±5%	GRT1555C2A270JA02#	D1			
			33pF	±5%	GRT1555C2A330JA02#	D1			
			39pF	±5%	GRT1555C2A390JA02#	D1			
			47pF	±5%	GRT1555C2A470JA02#	D1			
			56pF	±5%	GRT1555C2A560JA02#	D1			
			68pF	±5%	GRT1555C2A680JA02#	D1			
			82pF	±5%	GRT1555C2A820JA02#	D1			
			100pF	±5%	GRT1555C2A101JA02#	D1			
				50Vdc	COG	0.11pF	±0.1pF	GRT1555C1HR11BA02#	D1

T max.	Rated Voltage	TC Code	Cap.	Tol.	Part Number	
0.55mm	50Vdc	COG	0.12pF	±0.1pF	GRT1555C1HR12BA02#	D1
			0.13pF	±0.1pF	GRT1555C1HR13BA02#	D1
			0.15pF	±0.1pF	GRT1555C1HR15BA02#	D1
			0.16pF	±0.1pF	GRT1555C1HR16BA02#	D1
			0.18pF	±0.1pF	GRT1555C1HR18BA02#	D1
			0.20pF	±0.1pF	GRT1555C1HR20BA02#	D1
			0.22pF	±0.1pF	GRT1555C1HR22BA02#	D1
			0.24pF	±0.1pF	GRT1555C1HR24BA02#	D1
			0.27pF	±0.1pF	GRT1555C1HR27BA02#	D1
			0.30pF	±0.1pF	GRT1555C1HR30BA02#	D1
			0.33pF	±0.1pF	GRT1555C1HR33BA02#	D1
			0.36pF	±0.1pF	GRT1555C1HR36BA02#	D1
			0.39pF	±0.1pF	GRT1555C1HR39BA02#	D1
			0.43pF	±0.1pF	GRT1555C1HR43BA02#	D1
			0.47pF	±0.1pF	GRT1555C1HR47BA02#	D1
			0.51pF	±0.1pF	GRT1555C1HR51BA02#	D1
			0.56pF	±0.1pF	GRT1555C1HR56BA02#	D1
			0.62pF	±0.1pF	GRT1555C1HR62BA02#	D1
			0.68pF	±0.1pF	GRT1555C1HR68BA02#	D1
			0.75pF	±0.1pF	GRT1555C1HR75BA02#	D1
			0.82pF	±0.1pF	GRT1555C1HR82BA02#	D1
			0.91pF	±0.1pF	GRT1555C1HR91BA02#	D1
			1.0pF	±0.25pF	GRT1555C1H1R0CA02#	D1
			1.1pF	±0.25pF	GRT1555C1H1R1CA02#	D1
			1.2pF	±0.25pF	GRT1555C1H1R2CA02#	D1
			1.3pF	±0.25pF	GRT1555C1H1R3CA02#	D1
			1.5pF	±0.25pF	GRT1555C1H1R5CA02#	D1
			1.6pF	±0.25pF	GRT1555C1H1R6CA02#	D1
			1.8pF	±0.25pF	GRT1555C1H1R8CA02#	D1
			2.0pF	±0.25pF	GRT1555C1H2R0CA02#	D1
			2.2pF	±0.25pF	GRT1555C1H2R2CA02#	D1
			2.4pF	±0.25pF	GRT1555C1H2R4CA02#	D1
			2.7pF	±0.25pF	GRT1555C1H2R7CA02#	D1
			3.0pF	±0.25pF	GRT1555C1H3R0CA02#	D1
			3.3pF	±0.25pF	GRT1555C1H3R3CA02#	D1
			3.6pF	±0.25pF	GRT1555C1H3R6CA02#	D1
			3.9pF	±0.25pF	GRT1555C1H3R9CA02#	D1
			4.0pF	±0.25pF	GRT1555C1H4R0CA02#	D1
			4.3pF	±0.25pF	GRT1555C1H4R3CA02#	D1
			4.7pF	±0.25pF	GRT1555C1H4R7CA02#	D1
			5.0pF	±0.25pF	GRT1555C1H5R0CA02#	D1
			5.1pF	±0.5pF	GRT1555C1H5R1DA02#	D1
			5.6pF	±0.5pF	GRT1555C1H5R6DA02#	D1
			6.0pF	±0.5pF	GRT1555C1H6R0DA02#	D1
			6.2pF	±0.5pF	GRT1555C1H6R2DA02#	D1
			6.8pF	±0.5pF	GRT1555C1H6R8DA02#	D1
			7.0pF	±0.5pF	GRT1555C1H7R0DA02#	D1
			7.5pF	±0.5pF	GRT1555C1H7R5DA02#	D1
			8.0pF	±0.5pF	GRT1555C1H8R0DA02#	D1
			8.2pF	±0.5pF	GRT1555C1H8R2DA02#	D1
9.0pF	±0.5pF	GRT1555C1H9R0DA02#	D1			
9.1pF	±0.5pF	GRT1555C1H9R1DA02#	D1			
10pF	±1%	GRT1555C1H100FA02#	D1			
		±2%	GRT1555C1H100GA02#	D1		

Part number # indicates the package specification code.

GRT Series
 GCM Series
 GC3 Series
 GCJ Series
 GCQ Series
 GCD Series
 GCE Series
 NMF Series
 KCM Series
 KC3 Series
 KCA Series
 GCB Series
 GCG Series
 △Caution /Notice

GRT Series Temperature Compensating Type Part Number List

(→ 1.0×0.5mm)

T max.	Rated Voltage	TC Code	Cap.	Tol.	Part Number	
0.55mm	50Vdc	COG	10pF	±5%	GRT1555C1H100JA02#	D1
				±1%	GRT1555C1H110FA02#	D1
					GRT1555C1H110GA02#	D1
			±2%	GRT1555C1H110GA02#	D1	
				±5%	GRT1555C1H110JA02#	D1
					12pF	±1%
			±2%	GRT1555C1H120GA02#		D1
				±5%		GRT1555C1H120JA02#
			13pF		±1%	GRT1555C1H130FA02#
				±2%	GRT1555C1H130GA02#	D1
					±5%	GRT1555C1H130JA02#
			15pF	±1%		GRT1555C1H150FA02#
				±2%	GRT1555C1H150GA02#	D1
					±5%	GRT1555C1H150JA02#
			16pF	±1%		GRT1555C1H160FA02#
				±2%	GRT1555C1H160GA02#	D1
					±5%	GRT1555C1H160JA02#
			18pF	±1%		GRT1555C1H180FA02#
				±2%	GRT1555C1H180GA02#	D1
					±5%	GRT1555C1H180JA02#
			20pF	±1%		GRT1555C1H200FA02#
				±2%	GRT1555C1H200GA02#	D1
					±5%	GRT1555C1H200JA02#
			22pF	±1%		GRT1555C1H220FA02#
				±2%	GRT1555C1H220GA02#	D1
					±5%	GRT1555C1H220JA02#
			24pF	±1%		GRT1555C1H240FA02#
				±2%	GRT1555C1H240GA02#	D1
					±5%	GRT1555C1H240JA02#
			27pF	±1%		GRT1555C1H270FA02#
				±2%	GRT1555C1H270GA02#	D1
					±5%	GRT1555C1H270JA02#
			30pF	±1%		GRT1555C1H300FA02#
				±2%	GRT1555C1H300GA02#	D1
					±5%	GRT1555C1H300JA02#
			33pF	±1%		GRT1555C1H330FA02#
				±2%	GRT1555C1H330GA02#	D1
					±5%	GRT1555C1H330JA02#
			36pF	±1%		GRT1555C1H360FA02#
				±2%	GRT1555C1H360GA02#	D1
					±5%	GRT1555C1H360JA02#
			39pF	±1%		GRT1555C1H390FA02#
				±2%	GRT1555C1H390GA02#	D1
					±5%	GRT1555C1H390JA02#
			43pF	±1%		GRT1555C1H430FA02#
				±2%	GRT1555C1H430GA02#	D1
					±5%	GRT1555C1H430JA02#
			47pF	±1%		GRT1555C1H470FA02#
				±2%	GRT1555C1H470GA02#	D1
					±5%	GRT1555C1H470JA02#
			51pF	±1%		GRT1555C1H510FA02#
				±2%	GRT1555C1H510GA02#	D1
					±5%	GRT1555C1H510JA02#
			56pF	±1%		GRT1555C1H560FA02#
±2%	GRT1555C1H560GA02#	D1				

T max.	Rated Voltage	TC Code	Cap.	Tol.	Part Number	
0.55mm	50Vdc	COG	56pF	±5%	GRT1555C1H560JA02#	D1
				±1%	GRT1555C1H620FA02#	D1
					±2%	GRT1555C1H620GA02#
			±5%	GRT1555C1H620JA02#		D1
				68pF	±1%	GRT1555C1H680FA02#
			±2%		GRT1555C1H680GA02#	D1
					±5%	GRT1555C1H680JA02#
			75pF	±1%		GRT1555C1H750FA02#
				±2%	GRT1555C1H750GA02#	D1
					±5%	GRT1555C1H750JA02#
			82pF	±1%		GRT1555C1H820FA02#
				±2%	GRT1555C1H820GA02#	D1
					±5%	GRT1555C1H820JA02#
			91pF	±1%		GRT1555C1H910FA02#
				±2%	GRT1555C1H910GA02#	D1
					±5%	GRT1555C1H910JA02#
			100pF	±1%		GRT1555C1H101FA02#
				±2%	GRT1555C1H101GA02#	D1
					±5%	GRT1555C1H101JA02#
			110pF	±1%		GRT1555C1H111FA02#
				±2%	GRT1555C1H111GA02#	D1
					±5%	GRT1555C1H111JA02#
			120pF	±1%		GRT1555C1H121FA02#
				±2%	GRT1555C1H121GA02#	D1
					±5%	GRT1555C1H121JA02#
			130pF	±1%		GRT1555C1H131FA02#
				±2%	GRT1555C1H131GA02#	D1
					±5%	GRT1555C1H131JA02#
			150pF	±1%		GRT1555C1H151FA02#
				±2%	GRT1555C1H151GA02#	D1
					±5%	GRT1555C1H151JA02#
			160pF	±1%		GRT1555C1H161FA02#
				±2%	GRT1555C1H161GA02#	D1
					±5%	GRT1555C1H161JA02#
			180pF	±1%		GRT1555C1H181FA02#
				±2%	GRT1555C1H181GA02#	D1
					±5%	GRT1555C1H181JA02#
			200pF	±1%		GRT1555C1H201FA02#
				±2%	GRT1555C1H201GA02#	D1
					±5%	GRT1555C1H201JA02#
			220pF	±1%		GRT1555C1H221FA02#
				±2%	GRT1555C1H221GA02#	D1
					±5%	GRT1555C1H221JA02#
			240pF	±1%		GRT1555C1H241FA02#
				±2%	GRT1555C1H241GA02#	D1
					±5%	GRT1555C1H241JA02#
			270pF	±1%		GRT1555C1H271FA02#
				±2%	GRT1555C1H271GA02#	D1
					±5%	GRT1555C1H271JA02#
			300pF	±1%		GRT1555C1H301FA02#
				±2%	GRT1555C1H301GA02#	D1
					±5%	GRT1555C1H301JA02#
			330pF	±1%		GRT1555C1H331FA02#
				±2%	GRT1555C1H331GA02#	D1

Part number # indicates the package specification code.

GRT Series
 GCM Series
 GC3 Series
 GCJ Series
 GCQ Series
 GCD Series
 GCE Series
 NMF Series
 KCM Series
 KC3 Series
 KCA Series
 GCB Series
 GCG Series
 △Caution /Notice

GRT Series Temperature Compensating Type Part Number List

(→ 1.0×0.5mm)

T max.	Rated Voltage	TC Code	Cap.	Tol.	Part Number			
0.55mm	50Vdc	COG	330pF	±5%	GRT1555C1H331JA02#	D1		
				±1%	GRT1555C1H361FA02#	D1		
					±2%	GRT1555C1H361GA02#	D1	
					±5%	GRT1555C1H361JA02#	D1	
			390pF	±1%	GRT1555C1H391FA02#	D1		
				±2%	GRT1555C1H391GA02#	D1		
				±5%	GRT1555C1H391JA02#	D1		
			430pF	±1%	GRT1555C1H431FA02#	D1		
				±2%	GRT1555C1H431GA02#	D1		
				±5%	GRT1555C1H431JA02#	D1		
			470pF	±1%	GRT1555C1H471FA02#	D1		
				±2%	GRT1555C1H471GA02#	D1		
				±5%	GRT1555C1H471JA02#	D1		
			510pF	±1%	GRT1555C1H511FA02#	D1		
				±2%	GRT1555C1H511GA02#	D1		
				±5%	GRT1555C1H511JA02#	D1		
			560pF	±1%	GRT1555C1H561FA02#	D1		
				±2%	GRT1555C1H561GA02#	D1		
				±5%	GRT1555C1H561JA02#	D1		
			620pF	±1%	GRT1555C1H621FA02#	D1		
				±2%	GRT1555C1H621GA02#	D1		
				±5%	GRT1555C1H621JA02#	D1		
			680pF	±1%	GRT1555C1H681FA02#	D1		
				±2%	GRT1555C1H681GA02#	D1		
				±5%	GRT1555C1H681JA02#	D1		
			750pF	±1%	GRT1555C1H751FA02#	D1		
				±2%	GRT1555C1H751GA02#	D1		
				±5%	GRT1555C1H751JA02#	D1		
			820pF	±1%	GRT1555C1H821FA02#	D1		
				±2%	GRT1555C1H821GA02#	D1		
				±5%	GRT1555C1H821JA02#	D1		
			910pF	±1%	GRT1555C1H911FA02#	D1		
				±2%	GRT1555C1H911GA02#	D1		
				±5%	GRT1555C1H911JA02#	D1		
			1000pF	±1%	GRT1555C1H102FA02#	D1		
				±2%	GRT1555C1H102GA02#	D1		
				±5%	GRT1555C1H102JA02#	D1		
			25Vdc	COG	10pF	±5%	GRT1555C1E100JA02#	D1
					12pF	±5%	GRT1555C1E120JA02#	D1
					15pF	±5%	GRT1555C1E150JA02#	D1
					18pF	±5%	GRT1555C1E180JA02#	D1
					22pF	±5%	GRT1555C1E220JA02#	D1
					27pF	±5%	GRT1555C1E270JA02#	D1
					33pF	±5%	GRT1555C1E330JA02#	D1
					39pF	±5%	GRT1555C1E390JA02#	D1
					47pF	±5%	GRT1555C1E470JA02#	D1
					56pF	±5%	GRT1555C1E560JA02#	D1
					68pF	±5%	GRT1555C1E680JA02#	D1
82pF	±5%	GRT1555C1E820JA02#			D1			
100pF	±5%	GRT1555C1E101JA02#			D1			
120pF	±5%	GRT1555C1E121JA02#			D1			
150pF	±5%	GRT1555C1E151JA02#	D1					
180pF	±5%	GRT1555C1E181JA02#	D1					
220pF	±1%	GRT1555C1E221FA02#	D1					

T max.	Rated Voltage	TC Code	Cap.	Tol.	Part Number	
0.55mm	25Vdc	COG	220pF	±5%	GRT1555C1E221JA02#	D1
				±1%	GRT1555C1E271FA02#	D1
			±5%	GRT1555C1E271JA02#	D1	
				330pF	±5%	GRT1555C1E331JA02#
			390pF	±5%	GRT1555C1E391JA02#	D1
			470pF	±5%	GRT1555C1E471JA02#	D1
			560pF	±5%	GRT1555C1E561JA02#	D1
			680pF	±5%	GRT1555C1E681JA02#	D1
			820pF	±5%	GRT1555C1E821JA02#	D1
			1000pF	±5%	GRT1555C1E102JA02#	D1

1.6×0.8mm

T max.	Rated Voltage	TC Code	Cap.	Tol.	Part Number			
0.9mm	100Vdc	COG	120pF	±5%	GRT1885C2A121JA02#	D1		
				±5%	GRT1885C2A151JA02#	D1		
			180pF	±5%	GRT1885C2A181JA02#	D1		
				±5%	GRT1885C2A221JA02#	D1		
			270pF	±5%	GRT1885C2A271JA02#	D1		
				±5%	GRT1885C2A331JA02#	D1		
			390pF	±5%	GRT1885C2A391JA02#	D1		
				±5%	GRT1885C2A471JA02#	D1		
			560pF	±5%	GRT1885C2A561JA02#	D1		
				±5%	GRT1885C2A681JA02#	D1		
			820pF	±5%	GRT1885C2A821JA02#	D1		
				±5%	GRT1885C2A102JA02#	D1		
			1200pF	±5%	GRT1885C2A122JA02#	D1		
				±5%	GRT1885C2A152JA02#	D1		
			50Vdc	COG	1200pF	±5%	GRT1885C1H122JA02#	D1
						±2%	GRT1885C1H152GA02#	D1
					±5%	GRT1885C1H152JA02#	D1	
						1800pF	±5%	GRT1885C1H182JA02#
					2200pF	±2%	GRT1885C1H222GA02#	D1
					±5%	GRT1885C1H222JA02#	D1	
						2700pF	±5%	GRT1885C1H272JA02#
					3300pF	±5%	GRT1885C1H332JA02#	D1
					3900pF	±5%	GRT1885C1H392JA02#	D1
					4300pF	±5%	GRT1885C1H432JA02#	D1
	4700pF	±5%			GRT1885C1H472JA02#	D1		
	5100pF	±5%			GRT1885C1H512JA02#	D1		
	5600pF	±5%			GRT1885C1H562JA02#	D1		
	6800pF	±5%			GRT1885C1H682JA02#	D1		
	8200pF	±5%	GRT1885C1H822JA02#	D1				
	10000pF	±5%	GRT1885C1H103JA02#	D1				
	25Vdc	COG	1200pF	±5%	GRT1885C1E122JA02#	D1		
				±5%	GRT1885C1E152JA02#	D1		
			4700pF	±5%	GRT1885C1E472JA02#	D1		
				±5%	GRT1885C1E562JA02#	D1		
			5600pF	±5%	GRT1885C1E562JA02#	D1		
				±5%	GRT1885C1E682JA02#	D1		
			8200pF	±5%	GRT1885C1E822JA02#	D1		
				±1%	GRT1885C1E103FA02#	D1		
			±5%	GRT1885C1E103JA02#	D1			

Part number # indicates the package specification code.

GRT Series
 GCM Series
 GC3 Series
 GCJ Series
 GCQ Series
 GCD Series
 GCE Series
 NMF Series
 KCM Series
 KC3 Series
 KCA Series
 GCB Series
 GCG Series
 ⚠Caution /Notice

GRT Series Temperature Compensating Type Part Number List

2.0×1.25mm

T max.	Rated Voltage	TC Code	Cap.	Tol.	Part Number	
0.6mm	25Vdc	COG	1800pF	±5%	GRT2165C1E182JA12#	D1
			2200pF	±5%	GRT2165C1E222JA12#	D1
0.7mm	100Vdc	COG	1800pF	±5%	GRT2165C2A182JA02#	D1
			2200pF	±5%	GRT2165C2A222JA02#	D1
			2700pF	±5%	GRT2165C2A272JA02#	D1
			3300pF	±5%	GRT2165C2A332JA02#	D1
1.35mm	50Vdc	COG	18000pF	±5%	GRT21B5C1H183JA02#	D1
			22000pF	±5%	GRT21B5C1H223JA02#	D1

3.2×1.6mm

T max.	Rated Voltage	TC Code	Cap.	Tol.	Part Number	
0.95mm	100Vdc	COG	3900pF	±5%	GRT3195C2A392JA02#	D1
			4700pF	±5%	GRT3195C2A472JA02#	D1
			5600pF	±5%	GRT3195C2A562JA02#	D1
			6800pF	±5%	GRT3195C2A682JA02#	D1
			8200pF	±5%	GRT3195C2A822JA02#	D1
			10000pF	±5%	GRT3195C2A103JA02#	D1
			18000pF	±5%	GRT3195C2A183JA02#	D1
			22000pF	±5%	GRT3195C2A223JA02#	D1
1.8mm	100Vdc	COG	0.10μF	±5%	GRT31C5C2A104JA12#	D1
	50Vdc	COG	56000pF	±5%	GRT31C5C1H563JA02#	D1
			68000pF	±1%	GRT31C5C1H683FA02#	D1
				±5%	GRT31C5C1H683JA02#	D1
			82000pF	±5%	GRT31C5C1H823JA02#	D1
			0.10μF	±1%	GRT31C5C1H104FA02#	D1
	±5%	GRT31C5C1H104JA02#		D1		
	25Vdc	COG	0.10μF	±1%	GRT31C5C1E104FA02#	D1
				±5%	GRT31C5C1E104JA02#	D1
			0.12μF	±5%	GRT31C5C1E124JA02#	D1
16Vdc	COG	0.12μF	±5%	GRT31C5C1C124JA02#	D1	

GRT Series
 GCM Series
 GC3 Series
 GCJ Series
 GCQ Series
 GCD Series
 GCE Series
 NMF Series
 KCM Series
 KC3 Series
 KCA Series
 GCB Series
 GCG Series
 ⚠Caution /Notice

GRT Series High Dielectric Constant Type Part Number List

0.6×0.3mm

T max.	Rated Voltage	TC Code	Cap.	Tol.	Part Number			
0.33mm	35Vdc	X5R	0.10μF	±10%	GRT033R6YA104KE01#	D1		
			25Vdc	X7R	150pF	±10%	GRT033R71E151KE01#	D1
					470pF	±10%	GRT033R71E471KE01#	D1
	1000pF	±10%			GRT033R71E102KE01#	D1		
	X6S	150pF	±10%	GRT033C81E151KE01#	D1			
		470pF	±10%	GRT033C81E471KE01#	D1			
		1000pF	±10%	GRT033C81E102KE01#	D1			
		0.10μF	±10%	GRT033C81E104KE01#	D1			
		X5R	100pF	±10%	GRT033R61E101KE01#	D1		
			150pF	±10%	GRT033R61E151KE01#	D1		
			220pF	±10%	GRT033R61E221KE01#	D1		
			330pF	±10%	GRT033R61E331KE01#	D1		
			470pF	±10%	GRT033R61E471KE01#	D1		
			680pF	±10%	GRT033R61E681KE01#	D1		
			1000pF	±10%	GRT033R61E102KE01#	D1		
			4700pF	±10%	GRT033R61E472KE01#	D1		
			6800pF	±10%	GRT033R61E682KE01#	D1		
			10000pF	±10%	GRT033R61E103KE01#	D1		
			0.10μF	±10%	GRT033R61E104KE01#	D1		
	16Vdc		X7S	0.10μF	±10%	GRT033C71C104KE01#	D1	
		X6S		0.10μF	±10%	GRT033C81C104KE01#	D1	
		X5R	10000pF	±10%	GRT033R61C103KE01#	D1		
			15000pF	±10%	GRT033R61C153KE01#	D1		
			22000pF	±10%	GRT033R61C223KE01#	D1		
			33000pF	±10%	GRT033R61C333KE01#	D1		
			47000pF	±10%	GRT033R61C473KE01#	D1		
			68000pF	±10%	GRT033R61C683KE01#	D1		
			0.10μF	±10%	GRT033R61C104KE01#	D1		
			10Vdc	X7R	10000pF	±10%	GRT033R71A103KE01#	D1
	X7S	0.10μF			±10%	GRT033C71A104KE01#	D1	
	X6S	0.10μF			±10%	GRT033C81A104KE01#	D1	
	X5R	1500pF		±10%	GRT033R61A152KE01#	D1		
		2200pF		±10%	GRT033R61A222KE01#	D1		
		3300pF		±10%	GRT033R61A332KE01#	D1		
		4700pF		±10%	GRT033R61A472KE01#	D1		
		6800pF		±10%	GRT033R61A682KE01#	D1		
		10000pF		±10%	GRT033R61A103KE01#	D1		
		15000pF		±10%	GRT033R61A153KE01#	D1		
		22000pF		±10%	GRT033R61A223KE01#	D1		
		33000pF		±10%	GRT033R61A333KE01#	D1		
		47000pF		±10%	GRT033R61A473KE01#	D1		
		68000pF		±10%	GRT033R61A683KE01#	D1		
		0.10μF		±10%	GRT033R61A104KE01#	D1		
	0.22μF	±10%	GRT033R61A224KE01#	D1				
	6.3Vdc	X7R	2200pF	±10%	GRT033R70J222KE01#	D1		
3300pF			±10%	GRT033R70J332KE01#	D1			
4700pF			±10%	GRT033R70J472KE01#	D1			
6800pF			±10%	GRT033R70J682KE01#	D1			
10000pF			±10%	GRT033R70J103KE01#	D1			
X7S		0.10μF	±10%	GRT033C70J104KE01#	D1			
		X6S	2200pF	±10%	GRT033C80J222KE01#	D1		
			3300pF	±10%	GRT033C80J332KE01#	D1		

T max.	Rated Voltage	TC Code	Cap.	Tol.	Part Number		
0.33mm	6.3Vdc	X6S	4700pF	±10%	GRT033C80J472KE01#	D1	
			6800pF	±10%	GRT033C80J682KE01#	D1	
			10000pF	±10%	GRT033C80J103KE01#	D1	
			15000pF	±10%	GRT033C80J153KE01#	D1	
			22000pF	±10%	GRT033C80J223KE01#	D1	
			33000pF	±10%	GRT033C80J333KE01#	D1	
			47000pF	±10%	GRT033C80J473KE01#	D1	
			68000pF	±10%	GRT033C80J683KE01#	D1	
			0.10μF	±10%	GRT033C80J104KE01#	D1	
			0.22μF	±10%	GRT033C80J224KE01#	D1	
			X5R	10000pF	±10%	GRT033R60J103KE01#	D1
				15000pF	±10%	GRT033R60J153KE01#	D1
	22000pF	±10%		GRT033R60J223KE01#	D1		
	33000pF	±10%		GRT033R60J333KE01#	D1		
	47000pF	±10%		GRT033R60J473KE01#	D1		
	68000pF	±10%		GRT033R60J683KE01#	D1		
	82000pF	±10%		GRT033R60J823KE01#	D1		
	0.10μF	±10%		GRT033R60J104KE01#	D1		
	0.22μF	±10%		GRT033R60J224KE01#	D1		
	0.33μF	±20%		GRT033R60J334ME01#	D1		
	0.47μF	±10%		GRT033R60J474KE01#	D1		
	4Vdc	X6S		68000pF	±10%	GRT033C80G683KE01#	D1
			0.10μF	±10%	GRT033C80G104KE01#	D1	
			0.22μF	±20%	GRT033C80G224ME01#	D1	
0.35mm	6.3Vdc	X5R	1.0μF	±20%	GRT033R60J105ME13#	D1	
	4Vdc	X5R	1.0μF	±20%	GRT033R60G105ME13#	D1	
0.39mm	10Vdc	X6S	1.0μF	±20%	GRT033C81A105ME13#	D1	
			X7T	1.0μF	±20%	GRT033D70J105ME13#	D1
	6.3Vdc	X6S	1.0μF	±20%	GRT033C80J105ME13#	D1	
			X7T	1.0μF	±20%	GRT033D70G105ME13#	D1
2.5Vdc	X7T	1.0μF	±20%	GRT033D70E105ME18#	D1		

1.0×0.5mm

T max.	Rated Voltage	TC Code	Cap.	Tol.	Part Number	
0.22mm	6.3Vdc	X6S	0.22μF	±10%	GRT152C80J224KE13#	D1
			X5R	0.22μF	±10%	GRT152R60J224KE13#
	4Vdc	X6S	0.22μF	±10%	GRT152C80G224KE13#	D1
0.33mm	10Vdc	X5R	1.0μF	±20%	GRT153R61A105ME13#	D1
	6.3Vdc	X5R	1.0μF	±20%	GRT153R60J105ME13#	D1
0.55mm	50Vdc	X7R	220pF	±10%	GRT155R71H221KE01#	D1
			270pF	±10%	GRT155R71H271KE01#	D1
			330pF	±10%	GRT155R71H331KE01#	D1
			470pF	±10%	GRT155R71H471KE01#	D1
			680pF	±10%	GRT155R71H681KE01#	D1
			820pF	±10%	GRT155R71H821KE01#	D1
			1000pF	±10%	GRT155R71H102KE01#	D1
			1500pF	±10%	GRT155R71H152KE01#	D1
			2200pF	±10%	GRT155R71H222KE01#	D1
			2700pF	±10%	GRT155R71H272KE01#	D1
			3300pF	±10%	GRT155R71H332KE01#	D1
			4700pF	±10%	GRT155R71H472KE01#	D1

Part number # indicates the package specification code.

GRT Series
 GCM Series
 GC3 Series
 GCJ Series
 GCQ Series
 GCD Series
 GCE Series
 NMF Series
 KCM Series
 KC3 Series
 KCA Series
 GCB Series
 GCG Series
 ⚠Caution / Notice

GRT Series High Dielectric Constant Type Part Number List

(→ 1.0×0.5mm)

T max.	Rated Voltage	TC Code	Cap.	Tol.	Part Number			
0.55mm	50Vdc	X7R	6800pF	±10%	GRT155R71H682KE01#	D1		
			10000pF	±10%	GRT155R71H103KE01#	D1		
			15000pF	±10%	GRT155R71H153KE01#	D1		
			22000pF	±10%	GRT155R71H223KE01#	D1		
			33000pF	±10%	GRT155R71H333KE01#	D1		
			39000pF	±10%	GRT155R71H393KE01#	D1		
			47000pF	±10%	GRT155R71H473KE01#	D1		
			56000pF	±10%	GRT155R71H563KE01#	D1		
			68000pF	±10%	GRT155R71H683KE01#	D1		
			82000pF	±10%	GRT155R71H823KE01#	D1		
	0.10μF	±10%	GRT155R71H104KE01#	D1				
35Vdc	X6S	X5R	0.22μF	±10%	GRT155C8YA224KE01#	D1		
			0.47μF	±10%	GRT155R6YA474KE01#	D1		
			0.22μF	±10%	GRT155R6YA224KE01#	D1		
25Vdc	X7R	X5R	5600pF	±10%	GRT155R71E562KE01#	D1		
			10000pF	±10%	GRT155R71E103KE01#	D1		
			22000pF	±10%	GRT155R71E223KE01#	D1		
			33000pF	±10%	GRT155R71E333KE01#	D1		
			47000pF	±10%	GRT155R71E473KE01#	D1		
		0.10μF	±10%	GRT155R71E104KE01#	D1			
		X6S	0.22μF	±10%	GRT155C81E224KE01#	D1		
		X5R	0.22μF	±10%	GRT155R61E224KE01#	D1		
			0.47μF	±10%	GRT155R61E474KE01#	D1		
			1.0μF	±10%	GRT155R61E105KE01#	D1		
16Vdc	X7R	X5R	10000pF	±10%	GRT155R71C103KE01#	D1		
			22000pF	±10%	GRT155R71C223KE01#	D1		
			33000pF	±10%	GRT155R71C333KE01#	D1		
			47000pF	±10%	GRT155R71C473KE01#	D1		
			68000pF	±10%	GRT155R71C683KE01#	D1		
			0.10μF	±10%	GRT155R71C104KE01#	D1		
			0.22μF	±10%	GRT155R71C224KE01#	D1		
		X6S	0.47μF	±10%	GRT155C81C474KE01#	D1		
		X5R	0.22μF	±10%	GRT155R61C224KE01#	D1		
			0.47μF	±10%	GRT155R61C474KE01#	D1		
		1.0μF	±10%	GRT155R61C105KE01#	D1			
10Vdc	X7R	X5R	0.22μF	±10%	GRT155R71A224KE01#	D1		
			0.47μF	±10%	GRT155R71A474KE01#	D1		
	X6S	X5R	1.0μF	±10%	GRT155C81A105KE01#	D1		
			0.22μF	±10%	GRT155R61A224KE01#	D1		
	X5R	X5R	0.33μF	±10%	GRT155R61A334KE01#	D1		
			0.47μF	±10%	GRT155R61A474KE01#	D1		
			0.68μF	±10%	GRT155R61A684KE01#	D1		
			1.0μF	±10%	GRT155R61A105KE01#	D1		
			2.2μF	±10%	GRT155R61A225KE01#	D1		
					0.33μF	±10%	GRT155R61A334KE01#	D1
6.3Vdc	X7R	X5R	22000pF	±10%	GRT155R70J223KE01#	D1		
			1.0μF	±10%	GRT155R70J105KE01#	D1		
	X6S	X5R	0.22μF	±10%	GRT155C80J224KE01#	D1		
			0.33μF	±10%	GRT155C80J334KE01#	D1		
			0.47μF	±10%	GRT155C80J474KE01#	D1		
			0.68μF	±10%	GRT155C80J684KE01#	D1		
			1.0μF	±10%	GRT155C80J105KE01#	D1		
			2.2μF	±10%	GRT155C80J225KE01#	D1		
					0.22μF	±10%	GRT155R60J224KE01#	D1
					0.33μF	±10%	GRT155R60J334KE01#	D1

T max.	Rated Voltage	TC Code	Cap.	Tol.	Part Number	
0.55mm	6.3Vdc	X5R	0.47μF	±10%	GRT155R60J474KE01#	D1
			0.68μF	±10%	GRT155R60J684KE01#	D1
			1.0μF	±10%	GRT155R60J105KE01#	D1
			2.2μF	±10%	GRT155R60J225KE01#	D1
	4Vdc	X7R	1.0μF	±10%	GRT155R70G105KE01#	D1
			X6S	2.2μF	±10%	GRT155C80G225KE13#
0.6mm	35Vdc	X5R	1.0μF	±10%	GRT155R6YA105KE13#	D1
	25Vdc	X6S	1.0μF	±10%	GRT155C81E105KE13#	D1
	16Vdc	X6S	1.0μF	±10%	GRT155C81C105KE13#	D1
	10Vdc	X7S	1.0μF	±10%	GRT155C71A105KE13#	D1
	6.3Vdc	X5R	4.7μF	±20%	GRT155R60J475ME13#	D1
4Vdc	X5R	4.7μF	±20%	GRT155R60G475ME13#	D1	
				4.7μF	±20%	GRT155R61A475ME13#
0.65mm	10Vdc	X5R	4.7μF	±20%	GRT155R61A475ME13#	D1
	6.3Vdc	X6S	4.7μF	±20%	GRT155C80J475ME13#	D1
	4Vdc	X6S	4.7μF	±20%	GRT155C80G475ME13#	D1
0.7mm	25Vdc	X5R	2.2μF	±10%	GRT155R61E225KE13#	D1
			X6S	2.2μF	±10%	GRT155C81C225KE13#
	16Vdc	X5R	2.2μF	±10%	GRT155R61C225KE13#	D1
			X7S	2.2μF	±10%	GRT155C71A225KE13#
	10Vdc	X6S	2.2μF	±10%	GRT155C81A225KE13#	D1
			X7S	2.2μF	±10%	GRT155C70J225KE13#
2.5Vdc	X6S	10μF	±20%	GRT155C80E106ME13#	D1	

1.6×0.8mm

T max.	Rated Voltage	TC Code	Cap.	Tol.	Part Number		
0.9mm	100Vdc	X7R	3300pF	±10%	GRT188R72A332KE01#	D1	
			10000pF	±10%	GRT188R72A103KE01#	D1	
	50Vdc	X5R	1.0μF	±10%	GRT188R61H105KE13#	D1	
			X6S	1.0μF	±10%	GRT188C8YA105KE13#	D1
	35Vdc	X5R	2.2μF	±10%	GRT188R6YA225KE13#	D1	
			X7R	0.15μF	±10%	GRT188R71E154KE01#	D1
	25Vdc	X7R	0.22μF	±10%	GRT188R71E224KE01#	D1	
			0.47μF	±10%	GRT188R71E474KE13#	D1	
			1.0μF	±10%	GRT188R71E105KE13#	D1	
			0.33μF	±10%	GRT188R71C334KE01#	D1	
16Vdc	X7R	0.47μF	±10%	GRT188R71C474KE01#	D1		
		1.0μF	±10%	GRT188R71C105KE13#	D1		
6.3Vdc	X5R	10μF	±20%	GRT188R60J106ME13#	D1		
		4Vdc	X6S	1.0μF	±20%	GRT188C80G105ME01#	D1
4Vdc	X6S	4.7μF	±10%	GRT188C80G475KE01#	D1		
		10μF	±20%	GRT188C80G106ME13#	D1		
			X5R	10μF	±20%	GRT188R60G106ME13#	D1
				10μF	±10%	GRT188R61C106KE13#	D1
0.95mm	25Vdc	X5R	4.7μF	±10%	GRT188R61E475KE13#	D1	
	16Vdc	X6S	4.7μF	±10%	GRT188C81C475KE13#	D1	
			X5R	4.7μF	±10%	GRT188R61C475KE13#	D1
10Vdc	X5R	10μF	±10%	GRT188R61A106KE13#	D1		
		2.5Vdc	X5R	22μF	±20%	GRT188R60E226ME13#	D1
		50Vdc	X5R	2.2μF	±10%	GRT188R61H225KE13#	D1
X6S	2.2μF			±10%	GRT188C8YA225KE13#	D1	
35Vdc	X5R	4.7μF	±10%	GRT188R6YA475KE13#	D1		
		X7S	2.2μF	±10%	GRT188C71E225KE13#	D1	

Part number # indicates the package specification code.

GRT Series
 GCM Series
 GC3 Series
 GCJ Series
 GCQ Series
 GCD Series
 GCE Series
 NMF Series
 KCM Series
 KC3 Series
 KCA Series
 GCB Series
 GCG Series
 ⚠Caution / Notice

GRT Series High Dielectric Constant Type Part Number List

(→ 1.6×0.8mm)

T max.	Rated Voltage	TC Code	Cap.	Tol.	Part Number	
1.0mm	25Vdc	X6S	2.2μF	±10%	GRT188C81E225KE13#	D1
			4.7μF	±10%	GRT188C81E475KE13#	D1
		X5R	10μF	±20%	GRT188R61E106ME13#	D1
	16Vdc	X7S	2.2μF	±10%	GRT188C71C225KE13#	D1
		X6S	10μF	±20%	GRT188C81C106ME13#	D1
	10Vdc	X7T	10μF	±20%	GRT188D71A106ME13#	D1
		X6S	10μF	±20%	GRT188C81A106ME13#	D1
		X5R	22μF	±20%	GRT188R61A226ME13#	D1
	6.3Vdc	X7T	10μF	±20%	GRT188D70J106ME13#	D1
			X6S	10μF	±20%	GRT188C80J106ME13#
		X6S	22μF	±20%	GRT188C80J226ME13#	D1
			X5R	22μF	±20%	GRT188R60J226ME13#
4Vdc	X6S	22μF	±20%	GRT188C80G226ME13#	D1	

2.0×1.25mm

T max.	Rated Voltage	TC Code	Cap.	Tol.	Part Number	
0.95mm	16Vdc	X5R	3.3μF	±10%	GRT219R61C335KE01#	D1
	10Vdc	X6S	4.7μF	±10%	GRT219C81A475KE01#	D1
		X5R	3.3μF	±10%	GRT219R61A335KE01#	D1
1.35mm	100Vdc	X7R	47000pF	±10%	GRT21BR72A473KE01#	D1
	50Vdc	X7R	0.47μF	±10%	GRT21BR71H474KE01#	D1
			1.0μF	±10%	GRT21BR71H105KE01#	D1
16Vdc	X7R	2.2μF	±10%	GRT21BR71C225KE01#	D1	
1.4mm	50Vdc	X5R	4.7μF	±10%	GRT21BR61H475KE13#	D1
	35Vdc	X6S	4.7μF	±10%	GRT21BC8YA475KE13#	D1
	25Vdc	X7R	2.2μF	±10%	GRT21BR71E225KE13#	D1
		X6S	3.3μF	±10%	GRT21BC81E335KE13#	D1
	16Vdc	X7R	4.7μF	±10%	GRT21BR71C475KE13#	D1
		X6S	3.3μF	±10%	GRT21BC81C335KE13#	D1
	10Vdc	X7R	4.7μF	±10%	GRT21BR71A475KE13#	D1
		X5R	3.3μF	±10%	GRT21BR61A335KE13#	D1
	6.3Vdc	X5R	3.3μF	±10%	GRT21BR60J335KE13#	D1
	1.45mm	50Vdc	X7S	4.7μF	±10%	GRT21BC71H475KE13#
25Vdc		X7S	4.7μF	±10%	GRT21BC71E475KE13#	D1
			10μF	±10%	GRT21BC71E106KE13#	D1
		X5R	22μF	±20%	GRT21BR61E226ME13#	D1
16Vdc		X7S	10μF	±10%	GRT21BC71C106KE13#	D1
		X5R	22μF	±20%	GRT21BR61C226ME13#	D1
10Vdc		X7T	22μF	±20%	GRT21BD71A226ME13#	D1
		X6S	22μF	±20%	GRT21BC81A226ME13#	D1
6.3Vdc		X7T	22μF	±20%	GRT21BD70J226ME13#	D1
		X5R	47μF	±20%	GRT21BR60J476ME13#	D1
4Vdc		X6S	47μF	±20%	GRT21BC80G476ME13#	D1
		X5R	47μF	±20%	GRT21BR60G476ME13#	D1
2.5Vdc	X6S	47μF	±20%	GRT21BC80E476ME13#	D1	

3.2×1.6mm

T max.	Rated Voltage	TC Code	Cap.	Tol.	Part Number	
0.95mm	35Vdc	X5R	10μF	±10%	GRT319R6YA106KE01#	D1
1.25mm	50Vdc	X6S	1.0μF	±10%	GRT31MC81H105KE01#	D1

T max.	Rated Voltage	TC Code	Cap.	Tol.	Part Number		
1.25mm	25Vdc	X6S	1.5μF	±10%	GRT31MC81E155KE01#	D1	
			10μF	±10%	GRT31MC81E106KE01#	D1	
		X5R	1.5μF	±10%	GRT31MR61E155KE01#	D1	
	16Vdc	X6S	1.5μF	±10%	GRT31MC81C155KE01#	D1	
			6.8μF	±10%	GRT31MC81C685KE01#	D1	
		X5R	1.5μF	±10%	GRT31MR61C155KE01#	D1	
1.8mm	50Vdc	X7R	2.2μF	±10%	GRT31CR71H225KE13#	D1	
			X6S	1.5μF	±10%	GRT31CC81H155KE01#	D1
		X6S	2.2μF	±10%	GRT31CC81H225KE01#	D1	
			X5R	1.5μF	±10%	GRT31CR61H155KE01#	D1
	35Vdc	X6S	10μF	±10%	GRT31CC8YA106KE01#	D1	
			X5R	10μF	±10%	GRT31CR6YA106KE01#	D1
		25Vdc	X6S	10μF	±10%	GRT31CC81E106KE01#	D1
			X5R	3.3μF	±10%	GRT31CR61E335KE01#	D1
	16Vdc	X6S	22μF	±10%	GRT31CC81C226KE01#	D1	
		10Vdc	X5R	47μF	±10%	GRT31CR61A476KE13#	D1
	6.3Vdc	X6S	47μF	±10%	GRT31CC80J476KE13#	D1	
			X5R	15μF	±10%	GRT31CR60J156KE01#	D1

3.2×2.5mm

T max.	Rated Voltage	TC Code	Cap.	Tol.	Part Number	
1.5mm	25Vdc	X5R	6.8μF	±10%	GRT32NR61E685KE01#	D1
2.2mm	50Vdc	X6S	3.3μF	±10%	GRT32DC81H335KE01#	D1
		X5R	3.3μF	±10%	GRT32DR61H335KE01#	D1
2.7mm	6.3Vdc	X5R	33μF	±20%	GRT32DR60J336ME01#	D1
			4.7μF	±10%	GRT32ER71H475KE01#	D1
	50Vdc	X6S	4.7μF	±10%	GRT32EC81H475KE01#	D1
			±20%	GRT32EC81C476ME13#	D1	
	16Vdc	X6S	47μF	±10%	GRT32EC81C476KE13#	D1
			±20%	GRT32EC81C476ME13#	D1	
	10Vdc	X6S	47μF	±10%	GRT32EC81A476KE13#	D1
			6.3Vdc	X7R	47μF	±10%
4Vdc	X7S	100μF	±20%	GRT32EC70J107ME13#	D1	
		100μF	±20%	GRT32ER60J107ME13#	D1	
4Vdc	X7S	100μF	±20%	GRT32EC70G107ME13#	D1	

Part number # indicates the package specification code.

Chip Multilayer Ceramic Capacitors for Automotive

GCM Series



Capacitor for automotive applications such as power train and safety equipment.

Features

① Ideal for powertrains and safety devices in automotive.

This product can be used for safety devices, such as the drive system control for engine ECU, air bags, and ABS. This product has cleared test conditions more severe than that of general products (GRM Series) even in temperature cycle and humidity load tests.

	General Purpose GRM Series Maximum operating temperature: 125°C	GCM Series for Automotive Maximum operating temperature: 150°C
Items	Test Method	Test Method
Temperature Cycle	Temperature Cycle: 5 cycles	Temperature Cycle: 100 cycles (1,000 cycles for AEC-Q200 conforming products)
Humidity Loading	Test temperature: 40±2°C Test humidity: 90 to 95%RH Test time: 500 hours	Test temperature: 85±2°C Test humidity: 80 to 85%RH Test time: 500 hours (1,000 hours for AEC-Q200 conforming products)

② Can be used at 125°C and 150°C temperatures.

We also offer a lineup for 150°C that can be used in the engine room.

③ Sn plating is applied to the external electrodes; excellent solderability.

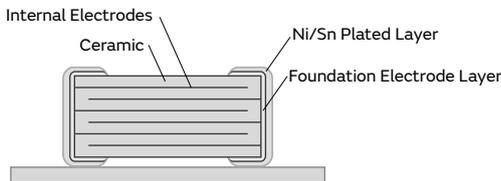

<Example of Structure>

Specifications

Size	0.6×0.3mm to 5.7×5.0mm
Rated Voltage	2.5Vdc to 1000Vdc
Capacitance	0.10pF to 100μF
Main Applications	Safety equipment, such as drive system control, air bags, and ABS of engine ECU

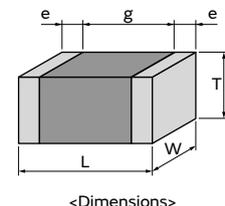

GRT Series
 GCM Series
 GC3 Series
 GCJ Series
 GCQ Series
 GCD Series
 GCE Series
 NMF Series
 KCM Series
 KC3 Series
 KCA Series
 GCB Series
 GCG Series
 △Caution / Notice

GCM Series Temperature Compensating Type Part Number List

0.6×0.3mm

T max.	Rated Voltage	TC Code	Cap.	Tol.	Part Number
0.33mm	50Vdc	COG	0.10pF	±0.05pF	GCM0335C1HR10WA16#
				±0.1pF	GCM0335C1HR11BA16#
			0.11pF	±0.05pF	GCM0335C1HR11WA16#
				±0.1pF	GCM0335C1HR11BA16#
			0.12pF	±0.05pF	GCM0335C1HR12WA16#
				±0.1pF	GCM0335C1HR12BA16#
			0.13pF	±0.05pF	GCM0335C1HR13WA16#
				±0.1pF	GCM0335C1HR13BA16#
			0.15pF	±0.05pF	GCM0335C1HR15WA16#
				±0.1pF	GCM0335C1HR15BA16#
			0.16pF	±0.05pF	GCM0335C1HR16WA16#
				±0.1pF	GCM0335C1HR16BA16#
			0.18pF	±0.05pF	GCM0335C1HR18WA16#
				±0.1pF	GCM0335C1HR18BA16#
			0.20pF	±0.05pF	GCM0335C1HR20WA16#
				±0.1pF	GCM0335C1HR20BA16#
			0.22pF	±0.05pF	GCM0335C1HR22WA16#
				±0.1pF	GCM0335C1HR22BA16#
			0.24pF	±0.05pF	GCM0335C1HR24WA16#
				±0.1pF	GCM0335C1HR24BA16#
			0.27pF	±0.05pF	GCM0335C1HR27WA16#
				±0.1pF	GCM0335C1HR27BA16#
			0.30pF	±0.05pF	GCM0335C1HR30WA16#
				±0.1pF	GCM0335C1HR30BA16#
			0.33pF	±0.05pF	GCM0335C1HR33WA16#
				±0.1pF	GCM0335C1HR33BA16#
			0.36pF	±0.05pF	GCM0335C1HR36WA16#
				±0.1pF	GCM0335C1HR36BA16#
			0.39pF	±0.05pF	GCM0335C1HR39WA16#
				±0.1pF	GCM0335C1HR39BA16#
			0.40pF	±0.05pF	GCM0335C1HR40WA16#
				±0.1pF	GCM0335C1HR40BA16#
			0.43pF	±0.05pF	GCM0335C1HR43WA16#
				±0.1pF	GCM0335C1HR43BA16#
			0.47pF	±0.05pF	GCM0335C1HR47WA16#
				±0.1pF	GCM0335C1HR47BA16#
			0.50pF	±0.05pF	GCM0335C1HR50WA16#
				±0.1pF	GCM0335C1HR50BA16#
			0.51pF	±0.05pF	GCM0335C1HR51WA16#
				±0.1pF	GCM0335C1HR51BA16#
0.56pF	±0.05pF	GCM0335C1HR56WA16#			
	±0.1pF	GCM0335C1HR56BA16#			
0.60pF	±0.05pF	GCM0335C1HR60WA16#			
	±0.1pF	GCM0335C1HR60BA16#			
0.62pF	±0.05pF	GCM0335C1HR62WA16#			
	±0.1pF	GCM0335C1HR62BA16#			
0.68pF	±0.05pF	GCM0335C1HR68WA16#			
	±0.1pF	GCM0335C1HR68BA16#			
0.70pF	±0.05pF	GCM0335C1HR70WA16#			
	±0.1pF	GCM0335C1HR70BA16#			
0.75pF	±0.05pF	GCM0335C1HR75WA16#			
	±0.1pF	GCM0335C1HR75BA16#			
0.80pF	±0.05pF	GCM0335C1HR80WA16#			

T max.	Rated Voltage	TC Code	Cap.	Tol.	Part Number
0.33mm	50Vdc	COG	0.80pF	±0.1pF	GCM0335C1HR80BA16#
				±0.05pF	GCM0335C1HR82WA16#
			0.82pF	±0.1pF	GCM0335C1HR82BA16#
				±0.05pF	GCM0335C1HR90WA16#
			0.90pF	±0.1pF	GCM0335C1HR90BA16#
				±0.05pF	GCM0335C1HR91WA16#
			0.91pF	±0.1pF	GCM0335C1HR91BA16#
				±0.05pF	GCM0335C1H1R0CA16#
			1.0pF	±0.25pF	GCM0335C1H1R1CA16#
				±0.25pF	GCM0335C1H1R2CA16#
			1.1pF	±0.25pF	GCM0335C1H1R3CA16#
				±0.25pF	GCM0335C1H1R5CA16#
			1.2pF	±0.25pF	GCM0335C1H1R6CA16#
				±0.25pF	GCM0335C1H1R8CA16#
			1.3pF	±0.25pF	GCM0335C1H2R0CA16#
				±0.25pF	GCM0335C1H2R2CA16#
			1.5pF	±0.25pF	GCM0335C1H2R4CA16#
				±0.25pF	GCM0335C1H2R7CA16#
			1.6pF	±0.25pF	GCM0335C1H3R0CA16#
				±0.25pF	GCM0335C1H3R3CA16#
			1.8pF	±0.25pF	GCM0335C1H3R6CA16#
				±0.25pF	GCM0335C1H3R9CA16#
			2.0pF	±0.25pF	GCM0335C1H4R0CA16#
				±0.25pF	GCM0335C1H4R3CA16#
			2.2pF	±0.25pF	GCM0335C1H4R7CA16#
				±0.25pF	GCM0335C1H5R0CA16#
			2.4pF	±0.25pF	GCM0335C1H5R1DA16#
				±0.25pF	GCM0335C1H5R6DA16#
			2.7pF	±0.25pF	GCM0335C1H6R0DA16#
				±0.5pF	GCM0335C1H6R2DA16#
			3.0pF	±0.25pF	GCM0335C1H6R8DA16#
				±0.5pF	GCM0335C1H7R0DA16#
			3.3pF	±0.25pF	GCM0335C1H7R5DA16#
				±0.5pF	GCM0335C1H8R0DA16#
			3.6pF	±0.25pF	GCM0335C1H8R2DA16#
				±0.5pF	GCM0335C1H9R0DA16#
			3.9pF	±0.25pF	GCM0335C1H9R1DA16#
				±1%	GCM0335C1H100FA16#
			4.0pF	±2%	GCM0335C1H100GA16#
				±5%	GCM0335C1H100JA16#
±1%	GCM0335C1H110FA16#				
4.3pF	±2%	GCM0335C1H110GA16#			
	±5%	GCM0335C1H110JA16#			
	±1%	GCM0335C1H120FA16#			
4.7pF	±2%	GCM0335C1H120GA16#			
	±5%	GCM0335C1H120JA16#			
	±1%	GCM0335C1H130FA16#			
5.0pF	±2%	GCM0335C1H130GA16#			
	±5%	GCM0335C1H130JA16#			
	±1%	GCM0335C1H150FA16#			
5.1pF	±2%	GCM0335C1H150GA16#			
	±5%	GCM0335C1H150JA16#			
	±1%	GCM0335C1H160FA16#			
5.6pF	±2%	GCM0335C1H160GA16#			

GRT Series
 GCM Series
 GC3 Series
 GCJ Series
 GCQ Series
 GCD Series
 GCE Series
 NMF Series
 KCM Series
 KC3 Series
 KCA Series
 GCB Series
 GCG Series
 ⚠Caution /Notice

Part number # indicates the package specification code.

GCM Series Temperature Compensating Type Part Number List

(→ 0.6×0.3mm)

T max.	Rated Voltage	TC Code	Cap.	Tol.	Part Number
0.33mm	50Vdc	COG	16pF	±5%	GCM0335C1H160JA16#
				±1%	GCM0335C1H180FA16#
					±2%
			±5%	GCM0335C1H180JA16#	
				±1%	GCM0335C1H200FA16#
					±2%
			±5%		GCM0335C1H200JA16#
			±1%	GCM0335C1H220FA16#	
				±2%	GCM0335C1H220GA16#
				±5%	GCM0335C1H220JA16#
			±1%	GCM0335C1H240FA16#	
				±2%	GCM0335C1H240GA16#
				±5%	GCM0335C1H240JA16#
			±1%	GCM0335C1H270FA16#	
				±2%	GCM0335C1H270GA16#
				±5%	GCM0335C1H270JA16#
			±1%	GCM0335C1H300FA16#	
				±2%	GCM0335C1H300GA16#
				±5%	GCM0335C1H300JA16#
			±1%	GCM0335C1H330FA16#	
				±2%	GCM0335C1H330GA16#
				±5%	GCM0335C1H330JA16#
			±1%	GCM0335C1H360FA16#	
				±2%	GCM0335C1H360GA16#
				±5%	GCM0335C1H360JA16#
			±1%	GCM0335C1H390FA16#	
				±2%	GCM0335C1H390GA16#
				±5%	GCM0335C1H390JA16#
			±1%	GCM0335C1H430FA16#	
				±2%	GCM0335C1H430GA16#
				±5%	GCM0335C1H430JA16#
			±1%	GCM0335C1H470FA16#	
				±2%	GCM0335C1H470GA16#
				±5%	GCM0335C1H470JA16#
			±1%	GCM0335C1H510FA16#	
				±2%	GCM0335C1H510GA16#
				±5%	GCM0335C1H510JA16#
			±1%	GCM0335C1H560FA16#	
				±2%	GCM0335C1H560GA16#
				±5%	GCM0335C1H560JA16#
			±1%	GCM0335C1H620FA16#	
				±2%	GCM0335C1H620GA16#
				±5%	GCM0335C1H620JA16#
			±1%	GCM0335C1H680FA16#	
				±2%	GCM0335C1H680GA16#
				±5%	GCM0335C1H680JA16#
			±1%	GCM0335C1H750FA16#	
				±2%	GCM0335C1H750GA16#
				±5%	GCM0335C1H750JA16#
			±1%	GCM0335C1H820FA16#	
				±2%	GCM0335C1H820GA16#
				±5%	GCM0335C1H820JA16#
			±1%	GCM0335C1H910FA16#	
				±2%	GCM0335C1H910GA16#

T max.	Rated Voltage	TC Code	Cap.	Tol.	Part Number		
0.33mm	50Vdc	COG	91pF	±5%	GCM0335C1H910JA16#		
				±1%	GCM0335C1H101FA16#		
					±2%	GCM0335C1H101GA16#	
					±5%	GCM0335C1H101JA16#	
			25Vdc	COG	0.10pF	±0.05pF	GCM0335C1ER10WA16#
						±0.05pF	GCM0335C1ER11WA16#
							±0.1pF
					±0.05pF	GCM0335C1ER12WA16#	
						±0.1pF	GCM0335C1ER12BA16#
						±0.05pF	GCM0335C1ER13WA16#
					±0.05pF	GCM0335C1ER13BA16#	
						±0.05pF	GCM0335C1ER15WA16#
							±0.1pF
					±0.05pF		GCM0335C1ER16WA16#
						±0.1pF	GCM0335C1ER16BA16#
						±0.05pF	GCM0335C1ER18WA16#
					±0.1pF		GCM0335C1ER18BA16#
					±0.05pF		GCM0335C1ER20WA16#
						±0.1pF	GCM0335C1ER20BA16#
						±0.05pF	GCM0335C1ER22WA16#
					±0.1pF		GCM0335C1ER22BA16#
					±0.05pF		GCM0335C1ER24WA16#
						±0.1pF	GCM0335C1ER24BA16#
						±0.05pF	GCM0335C1ER27WA16#
					±0.1pF		GCM0335C1ER27BA16#
					±0.05pF		GCM0335C1ER30WA16#
						±0.1pF	GCM0335C1ER30BA16#
						±0.05pF	GCM0335C1ER33WA16#
					±0.1pF		GCM0335C1ER33BA16#
					±0.05pF		GCM0335C1ER36WA16#
						±0.1pF	GCM0335C1ER36BA16#
						±0.05pF	GCM0335C1ER39WA16#
					±0.1pF		GCM0335C1ER39BA16#
					±0.05pF		GCM0335C1ER40WA16#
						±0.1pF	GCM0335C1ER40BA16#
						±0.05pF	GCM0335C1ER43WA16#
					±0.1pF		GCM0335C1ER43BA16#
					±0.05pF		GCM0335C1ER47WA16#
						±0.1pF	GCM0335C1ER47BA16#
						±0.05pF	GCM0335C1ER50WA16#
					±0.1pF		GCM0335C1ER50BA16#
					±0.05pF		GCM0335C1ER51WA16#
						±0.1pF	GCM0335C1ER51BA16#
						±0.05pF	GCM0335C1ER56WA16#
					±0.1pF		GCM0335C1ER56BA16#
					±0.05pF		GCM0335C1ER60WA16#
						±0.1pF	GCM0335C1ER60BA16#
						±0.05pF	GCM0335C1ER62WA16#
					±0.1pF		GCM0335C1ER62BA16#
					±0.05pF		GCM0335C1ER68WA16#
						±0.1pF	GCM0335C1ER68BA16#
						±0.05pF	GCM0335C1ER70WA16#
					±0.1pF		GCM0335C1ER70BA16#
					±0.05pF		GCM0335C1ER75WA16#

Part number # indicates the package specification code.

GRT Series
 GCM Series
 GC3 Series
 GCJ Series
 GCQ Series
 GCD Series
 GCE Series
 NMF Series
 KCM Series
 KC3 Series
 KCA Series
 GCB Series
 GCG Series
 ⚠Caution /Notice

GCM Series Temperature Compensating Type Part Number List

(→ 0.6×0.3mm)

T max.	Rated Voltage	TC Code	Cap.	Tol.	Part Number	T max.	Rated Voltage	TC Code	Cap.	Tol.	Part Number
0.33mm	25Vdc	COG	0.75pF	±0.1pF	GCM0335C1ER75BA16#	0.33mm	25Vdc	COG	15pF	±1%	GCM0335C1E150FA16#
				±0.05pF	GCM0335C1ER80WA16#					±2%	GCM0335C1E150GA16#
			±0.1pF	GCM0335C1ER80BA16#	±5%					GCM0335C1E150JA16#	
			0.82pF	±0.05pF	GCM0335C1ER82WA16#				16pF	±1%	GCM0335C1E160FA16#
				±0.1pF	GCM0335C1ER82BA16#					±2%	GCM0335C1E160GA16#
			0.90pF	±0.05pF	GCM0335C1ER90WA16#					±5%	GCM0335C1E160JA16#
				±0.1pF	GCM0335C1ER90BA16#				18pF	±1%	GCM0335C1E180FA16#
			0.91pF	±0.05pF	GCM0335C1ER91WA16#					±2%	GCM0335C1E180GA16#
				±0.1pF	GCM0335C1ER91BA16#					±5%	GCM0335C1E180JA16#
			1.0pF	±0.25pF	GCM0335C1E1R0CA16#				20pF	±1%	GCM0335C1E200FA16#
			1.1pF	±0.25pF	GCM0335C1E1R1CA16#					±2%	GCM0335C1E200GA16#
			1.2pF	±0.25pF	GCM0335C1E1R2CA16#					±5%	GCM0335C1E200JA16#
			1.3pF	±0.25pF	GCM0335C1E1R3CA16#				22pF	±1%	GCM0335C1E220FA16#
			1.5pF	±0.25pF	GCM0335C1E1R5CA16#					±2%	GCM0335C1E220GA16#
			1.6pF	±0.25pF	GCM0335C1E1R6CA16#					±5%	GCM0335C1E220JA16#
			1.8pF	±0.25pF	GCM0335C1E1R8CA16#				24pF	±1%	GCM0335C1E240FA16#
			2.0pF	±0.25pF	GCM0335C1E2R0CA16#					±2%	GCM0335C1E240GA16#
			2.2pF	±0.25pF	GCM0335C1E2R2CA16#					±5%	GCM0335C1E240JA16#
			2.4pF	±0.25pF	GCM0335C1E2R4CA16#				27pF	±1%	GCM0335C1E270FA16#
			2.7pF	±0.25pF	GCM0335C1E2R7CA16#					±2%	GCM0335C1E270GA16#
			3.0pF	±0.25pF	GCM0335C1E3R0CA16#					±5%	GCM0335C1E270JA16#
			3.3pF	±0.25pF	GCM0335C1E3R3CA16#				30pF	±1%	GCM0335C1E300FA16#
			3.6pF	±0.25pF	GCM0335C1E3R6CA16#					±2%	GCM0335C1E300GA16#
			3.9pF	±0.25pF	GCM0335C1E3R9CA16#					±5%	GCM0335C1E300JA16#
			4.0pF	±0.25pF	GCM0335C1E4R0CA16#				33pF	±1%	GCM0335C1E330FA16#
			4.3pF	±0.25pF	GCM0335C1E4R3CA16#					±2%	GCM0335C1E330GA16#
			4.7pF	±0.25pF	GCM0335C1E4R7CA16#					±5%	GCM0335C1E330JA16#
			5.0pF	±0.25pF	GCM0335C1E5R0CA16#				36pF	±1%	GCM0335C1E360FA16#
			5.1pF	±0.5pF	GCM0335C1E5R1DA16#					±2%	GCM0335C1E360GA16#
			5.6pF	±0.25pF	GCM0335C1E5R6CA16#					±5%	GCM0335C1E360JA16#
				±0.5pF	GCM0335C1E5R6DA16#				39pF	±1%	GCM0335C1E390FA16#
			6.0pF	±0.5pF	GCM0335C1E6R0DA16#					±2%	GCM0335C1E390GA16#
			6.2pF	±0.5pF	GCM0335C1E6R2DA16#					±5%	GCM0335C1E390JA16#
			6.8pF	±0.25pF	GCM0335C1E6R8CA16#				43pF	±1%	GCM0335C1E430FA16#
				±0.5pF	GCM0335C1E6R8DA16#					±2%	GCM0335C1E430GA16#
			7.0pF	±0.5pF	GCM0335C1E7R0DA16#					±5%	GCM0335C1E430JA16#
			7.5pF	±0.5pF	GCM0335C1E7R5DA16#				47pF	±1%	GCM0335C1E470FA16#
			8.0pF	±0.5pF	GCM0335C1E8R0DA16#					±2%	GCM0335C1E470GA16#
			8.2pF	±0.25pF	GCM0335C1E8R2CA16#					±5%	GCM0335C1E470JA16#
				±0.5pF	GCM0335C1E8R2DA16#				51pF	±1%	GCM0335C1E510FA16#
			9.0pF	±0.5pF	GCM0335C1E9R0DA16#					±2%	GCM0335C1E510GA16#
			9.1pF	±0.5pF	GCM0335C1E9R1DA16#					±5%	GCM0335C1E510JA16#
			10pF	±1%	GCM0335C1E100FA16#				56pF	±1%	GCM0335C1E560FA16#
				±2%	GCM0335C1E100GA16#					±2%	GCM0335C1E560GA16#
				±5%	GCM0335C1E100JA16#					±5%	GCM0335C1E560JA16#
			11pF	±1%	GCM0335C1E110FA16#				62pF	±1%	GCM0335C1E620FA16#
				±2%	GCM0335C1E110GA16#					±2%	GCM0335C1E620GA16#
				±5%	GCM0335C1E110JA16#					±5%	GCM0335C1E620JA16#
			12pF	±1%	GCM0335C1E120FA16#				68pF	±1%	GCM0335C1E680FA16#
				±2%	GCM0335C1E120GA16#					±2%	GCM0335C1E680GA16#
±5%	GCM0335C1E120JA16#	±5%		GCM0335C1E680JA16#							
13pF	±1%	GCM0335C1E130FA16#	75pF	±1%	GCM0335C1E750FA16#						
	±2%	GCM0335C1E130GA16#		±2%	GCM0335C1E750GA16#						
	±5%	GCM0335C1E130JA16#		±5%	GCM0335C1E750JA16#						

Part number # indicates the package specification code.

GRT Series
 GCM Series
 GC3 Series
 GCJ Series
 GCQ Series
 GCD Series
 GCE Series
 NMF Series
 KCM Series
 KC3 Series
 KCA Series
 GCB Series
 GCG Series
 ⚠Caution / Notice

GCM Series Temperature Compensating Type Part Number List

(→ 0.6×0.3mm)

T max.	Rated Voltage	TC Code	Cap.	Tol.	Part Number
0.33mm	25Vdc	COG	82pF	±1%	GCM0335C1E820FA16#
				±2%	GCM0335C1E820GA16#
				±5%	GCM0335C1E820JA16#
			91pF	±1%	GCM0335C1E910FA16#
				±2%	GCM0335C1E910GA16#
				±5%	GCM0335C1E910JA16#
			100pF	±1%	GCM0335C1E101FA16#
				±2%	GCM0335C1E101GA16#
				±5%	GCM0335C1E101JA16#

T max.	Rated Voltage	TC Code	Cap.	Tol.	Part Number
0.55mm	50Vdc	COG	1.0pF	±0.1pF	GCM1555C1H1R0BA16#
				±0.25pF	GCM1555C1H1R0CA16#
				±5%	GCM1555C1H1R0JA16#
			1.1pF	±0.1pF	GCM1555C1H1R1BA16#
				±0.25pF	GCM1555C1H1R1CA16#
			1.2pF	±0.1pF	GCM1555C1H1R2BA16#
				±0.25pF	GCM1555C1H1R2CA16#
			1.3pF	±0.1pF	GCM1555C1H1R3BA16#
				±0.25pF	GCM1555C1H1R3CA16#
			1.4pF	±0.1pF	GCM1555C1H1R4BA16#
				±0.25pF	GCM1555C1H1R4CA16#
			1.5pF	±0.05pF	GCM1555C1H1R5WA16#
				±0.1pF	GCM1555C1H1R5BA16#
				±0.25pF	GCM1555C1H1R5CA16#
				±5%	GCM1555C1H1R5JA16#
			1.6pF	±0.05pF	GCM1555C1H1R6WA16#
				±0.1pF	GCM1555C1H1R6BA16#
				±0.25pF	GCM1555C1H1R6CA16#
				1.7pF	±0.1pF
			±0.25pF		GCM1555C1H1R7CA16#
			1.8pF	±0.05pF	GCM1555C1H1R8WA16#
				±0.1pF	GCM1555C1H1R8BA16#
				±0.25pF	GCM1555C1H1R8CA16#
			1.9pF	±0.1pF	GCM1555C1H1R9BA16#
				±0.25pF	GCM1555C1H1R9CA16#
			2.0pF	±0.1pF	GCM1555C1H2R0BA16#
				±0.25pF	GCM1555C1H2R0CA16#
			2.1pF	±0.1pF	GCM1555C1H2R1BA16#
				±0.25pF	GCM1555C1H2R1CA16#
			2.2pF	±0.05pF	GCM1555C1H2R2WA16#
				±0.1pF	GCM1555C1H2R2BA16#
				±0.25pF	GCM1555C1H2R2CA16#
			2.3pF	±0.1pF	GCM1555C1H2R3BA16#
				±0.25pF	GCM1555C1H2R3CA16#
			2.4pF	±0.1pF	GCM1555C1H2R4BA16#
				±0.25pF	GCM1555C1H2R4CA16#
			2.5pF	±0.1pF	GCM1555C1H2R5BA16#
				±0.25pF	GCM1555C1H2R5CA16#
			2.6pF	±0.1pF	GCM1555C1H2R6BA16#
				±0.25pF	GCM1555C1H2R6CA16#
			2.7pF	±0.05pF	GCM1555C1H2R7WA16#
				±0.1pF	GCM1555C1H2R7BA16#
				±0.25pF	GCM1555C1H2R7CA16#
			2.8pF	±0.1pF	GCM1555C1H2R8BA16#
				±0.25pF	GCM1555C1H2R8CA16#
			2.9pF	±0.1pF	GCM1555C1H2R9BA16#
				±0.25pF	GCM1555C1H2R9CA16#
			3.0pF	±0.1pF	GCM1555C1H3R0BA16#
±0.25pF	GCM1555C1H3R0CA16#				
3.1pF	±0.1pF	GCM1555C1H3R1BA16#			
	±0.25pF	GCM1555C1H3R1CA16#			
3.2pF	±0.1pF	GCM1555C1H3R2BA16#			
	±0.25pF	GCM1555C1H3R2CA16#			
3.3pF	±0.1pF	GCM1555C1H3R3BA16#			

1.0×0.5mm

T max.	Rated Voltage	TC Code	Cap.	Tol.	Part Number
0.55mm	50Vdc	COG	0.10pF	±0.1pF	GCM1555C1HR10BA16#
				±0.1pF	GCM1555C1HR11BA16#
			0.11pF	±0.1pF	GCM1555C1HR12BA16#
				±0.1pF	GCM1555C1HR13BA16#
			0.12pF	±0.1pF	GCM1555C1HR14BA16#
				±0.1pF	GCM1555C1HR15BA16#
			0.13pF	±0.1pF	GCM1555C1HR16BA16#
				±0.1pF	GCM1555C1HR17BA16#
			0.15pF	±0.1pF	GCM1555C1HR18BA16#
				±0.1pF	GCM1555C1HR19BA16#
			0.16pF	±0.1pF	GCM1555C1HR20BA16#
				±20%	GCM1555C1HR20MA16#
			0.18pF	±0.1pF	GCM1555C1HR21BA16#
				±0.1pF	GCM1555C1HR22BA16#
			0.20pF	±0.1pF	GCM1555C1HR23BA16#
				±0.1pF	GCM1555C1HR24BA16#
			0.22pF	±0.1pF	GCM1555C1HR25BA16#
				±0.1pF	GCM1555C1HR26BA16#
			0.24pF	±0.1pF	GCM1555C1HR27BA16#
				±0.1pF	GCM1555C1HR28BA16#
			0.30pF	±0.05pF	GCM1555C1HR30WA16#
				±0.1pF	GCM1555C1HR30BA16#
			0.33pF	±0.1pF	GCM1555C1HR31BA16#
				±0.1pF	GCM1555C1HR32BA16#
			0.36pF	±0.1pF	GCM1555C1HR33BA16#
				±0.1pF	GCM1555C1HR34BA16#
			0.39pF	±0.1pF	GCM1555C1HR35BA16#
				±0.1pF	GCM1555C1HR36BA16#
			0.40pF	±0.05pF	GCM1555C1HR37WA16#
				±0.1pF	GCM1555C1HR37BA16#
			0.43pF	±0.1pF	GCM1555C1HR38BA16#
				±0.1pF	GCM1555C1HR39BA16#
			0.47pF	±0.1pF	GCM1555C1HR40BA16#
				±0.25pF	GCM1555C1HR40CA16#
			0.50pF	±0.05pF	GCM1555C1HR41WA16#
				±0.1pF	GCM1555C1HR41BA16#
				±0.25pF	GCM1555C1HR41CA16#
			0.51pF	±0.1pF	GCM1555C1HR42BA16#
				±0.1pF	GCM1555C1HR43BA16#
			0.56pF	±0.1pF	GCM1555C1HR44BA16#
				±0.1pF	GCM1555C1HR45BA16#
			0.60pF	±0.05pF	GCM1555C1HR46WA16#
				±0.1pF	GCM1555C1HR46BA16#
			0.62pF	±0.1pF	GCM1555C1HR47BA16#
				±0.1pF	GCM1555C1HR48BA16#
			0.68pF	±0.1pF	GCM1555C1HR49BA16#
				±0.1pF	GCM1555C1HR50BA16#
			0.70pF	±0.05pF	GCM1555C1HR51WA16#
				±0.1pF	GCM1555C1HR51BA16#
			0.75pF	±0.1pF	GCM1555C1HR52BA16#
				±0.25pF	GCM1555C1HR52CA16#
			0.80pF	±0.05pF	GCM1555C1HR53WA16#
±0.1pF	GCM1555C1HR53BA16#				
0.82pF	±0.1pF	GCM1555C1HR54BA16#			
	±0.1pF	GCM1555C1HR55BA16#			
0.90pF	±0.05pF	GCM1555C1HR56WA16#			
	±0.1pF	GCM1555C1HR56BA16#			
0.91pF	±0.1pF	GCM1555C1HR57BA16#			

Part number # indicates the package specification code.

GRT Series
 GCM Series
 GC3 Series
 GCJ Series
 GCQ Series
 GCD Series
 GCE Series
 NMF Series
 KCM Series
 KC3 Series
 KCA Series
 GCB Series
 GCG Series
 ⚠Caution /Notice

GCM Series Temperature Compensating Type Part Number List

(→ 1.0×0.5mm)

T max.	Rated Voltage	TC Code	Cap.	Tol.	Part Number
0.55mm	50Vdc	COG	3.3pF	±0.25pF	GCM1555C1H3R3CA16#
				±2%	GCM1555C1H3R3GA16#
			3.4pF	±0.1pF	GCM1555C1H3R4BA16#
				±0.25pF	GCM1555C1H3R4CA16#
			3.5pF	±0.1pF	GCM1555C1H3R5BA16#
				±0.25pF	GCM1555C1H3R5CA16#
			3.6pF	±0.1pF	GCM1555C1H3R6BA16#
				±0.25pF	GCM1555C1H3R6CA16#
			3.7pF	±0.25pF	GCM1555C1H3R7CA16#
			3.8pF	±0.25pF	GCM1555C1H3R8CA16#
			3.9pF	±0.1pF	GCM1555C1H3R9BA16#
				±0.25pF	GCM1555C1H3R9CA16#
			4.0pF	±0.1pF	GCM1555C1H4R0BA16#
				±0.25pF	GCM1555C1H4R0CA16#
				±2%	GCM1555C1H4R0GA16#
				±5%	GCM1555C1H4R0JA16#
			4.1pF	±0.25pF	GCM1555C1H4R1CA16#
			4.2pF	±0.1pF	GCM1555C1H4R2BA16#
				±0.25pF	GCM1555C1H4R2CA16#
			4.3pF	±0.1pF	GCM1555C1H4R3BA16#
				±0.25pF	GCM1555C1H4R3CA16#
			4.4pF	±0.25pF	GCM1555C1H4R4CA16#
			4.5pF	±0.25pF	GCM1555C1H4R5CA16#
			4.6pF	±0.25pF	GCM1555C1H4R6CA16#
			4.7pF	±0.05pF	GCM1555C1H4R7WA16#
				±0.1pF	GCM1555C1H4R7BA16#
				±0.25pF	GCM1555C1H4R7CA16#
			4.8pF	±0.25pF	GCM1555C1H4R8CA16#
			4.9pF	±0.25pF	GCM1555C1H4R9CA16#
			5.0pF	±0.1pF	GCM1555C1H5R0BA16#
				±0.25pF	GCM1555C1H5R0CA16#
				±1%	GCM1555C1H5R0FA16#
			5.1pF	±0.1pF	GCM1555C1H5R1BA16#
				±0.25pF	GCM1555C1H5R1CA16#
				±0.5pF	GCM1555C1H5R1DA16#
				±1%	GCM1555C1H5R1FA16#
			5.2pF	±0.25pF	GCM1555C1H5R2CA16#
				±0.5pF	GCM1555C1H5R2DA16#
			5.3pF	±0.05pF	GCM1555C1H5R3WA16#
				±0.5pF	GCM1555C1H5R3DA16#
			5.4pF	±0.5pF	GCM1555C1H5R4DA16#
			5.5pF	±0.05pF	GCM1555C1H5R5WA16#
				±0.5pF	GCM1555C1H5R5DA16#
			5.6pF	±0.1pF	GCM1555C1H5R6BA16#
				±0.25pF	GCM1555C1H5R6CA16#
				±0.5pF	GCM1555C1H5R6DA16#
			5.7pF	±0.5pF	GCM1555C1H5R7DA16#
			5.8pF	±0.5pF	GCM1555C1H5R8DA16#
			5.9pF	±0.5pF	GCM1555C1H5R9DA16#
			6.0pF	±0.1pF	GCM1555C1H6R0BA16#
				±0.25pF	GCM1555C1H6R0CA16#
				±0.5pF	GCM1555C1H6R0DA16#
				±1%	GCM1555C1H6R0FA16#
			6.1pF	±0.5pF	GCM1555C1H6R1DA16#

T max.	Rated Voltage	TC Code	Cap.	Tol.	Part Number
0.55mm	50Vdc	COG	6.2pF	±0.1pF	GCM1555C1H6R2BA16#
				±0.25pF	GCM1555C1H6R2CA16#
				±0.5pF	GCM1555C1H6R2DA16#
			6.3pF	±0.5pF	GCM1555C1H6R3DA16#
			6.4pF	±0.5pF	GCM1555C1H6R4DA16#
			6.5pF	±0.05pF	GCM1555C1H6R5WA16#
				±0.5pF	GCM1555C1H6R5DA16#
			6.6pF	±0.5pF	GCM1555C1H6R6DA16#
			6.7pF	±0.05pF	GCM1555C1H6R7WA16#
				±0.5pF	GCM1555C1H6R7DA16#
			6.8pF	±0.05pF	GCM1555C1H6R8WA16#
				±0.1pF	GCM1555C1H6R8BA16#
				±0.25pF	GCM1555C1H6R8CA16#
				±0.5pF	GCM1555C1H6R8DA16#
				±1%	GCM1555C1H6R8FA16#
			6.9pF	±0.5pF	GCM1555C1H6R9DA16#
			7.0pF	±0.05pF	GCM1555C1H7R0WA16#
				±0.1pF	GCM1555C1H7R0BA16#
				±0.25pF	GCM1555C1H7R0CA16#
				±0.5pF	GCM1555C1H7R0DA16#
				±1%	GCM1555C1H7R0FA16#
			7.1pF	±0.5pF	GCM1555C1H7R1DA16#
			7.2pF	±0.25pF	GCM1555C1H7R2CA16#
				±0.5pF	GCM1555C1H7R2DA16#
			7.3pF	±0.5pF	GCM1555C1H7R3DA16#
			7.4pF	±0.5pF	GCM1555C1H7R4DA16#
			7.5pF	±0.1pF	GCM1555C1H7R5BA16#
				±0.25pF	GCM1555C1H7R5CA16#
				±0.5pF	GCM1555C1H7R5DA16#
			7.6pF	±0.5pF	GCM1555C1H7R6DA16#
			7.7pF	±0.5pF	GCM1555C1H7R7DA16#
			7.8pF	±0.25pF	GCM1555C1H7R8CA16#
				±0.5pF	GCM1555C1H7R8DA16#
			7.9pF	±0.5pF	GCM1555C1H7R9DA16#
			8.0pF	±0.05pF	GCM1555C1H8R0WA16#
				±0.1pF	GCM1555C1H8R0BA16#
				±0.25pF	GCM1555C1H8R0CA16#
				±0.5pF	GCM1555C1H8R0DA16#
				±1%	GCM1555C1H8R0FA16#
			8.1pF	±0.5pF	GCM1555C1H8R1DA16#
			8.2pF	±0.1pF	GCM1555C1H8R2BA16#
				±0.25pF	GCM1555C1H8R2CA16#
				±0.5pF	GCM1555C1H8R2DA16#
			8.3pF	±0.5pF	GCM1555C1H8R3DA16#
			8.4pF	±0.1pF	GCM1555C1H8R4BA16#
				±0.5pF	GCM1555C1H8R4DA16#
			8.5pF	±0.5pF	GCM1555C1H8R5DA16#
			8.6pF	±0.5pF	GCM1555C1H8R6DA16#
			8.7pF	±0.1pF	GCM1555C1H8R7BA16#
				±0.5pF	GCM1555C1H8R7DA16#
			8.8pF	±0.5pF	GCM1555C1H8R8DA16#
			8.9pF	±0.5pF	GCM1555C1H8R9DA16#
			9.0pF	±0.05pF	GCM1555C1H9R0WA16#
				±0.1pF	GCM1555C1H9R0BA16#

Part number # indicates the package specification code.

GRT Series
 GCM Series
 GC3 Series
 GCJ Series
 GCQ Series
 GCD Series
 GCE Series
 NMF Series
 KCM Series
 KC3 Series
 KCA Series
 GCB Series
 GCG Series
 ⚠Caution /Notice

GCM Series Temperature Compensating Type Part Number List

(→ 1.0×0.5mm)

T max.	Rated Voltage	TC Code	Cap.	Tol.	Part Number	T max.	Rated Voltage	TC Code	Cap.	Tol.	Part Number	
0.55mm	50Vdc	COG	9.0pF	±0.25pF	GCM1555C1H9R0CA16#	0.55mm	50Vdc	COG	36pF	±1%	GCM1555C1H360FA16#	
				±0.5pF	GCM1555C1H9R0DA16#					±2%	GCM1555C1H360GA16#	
			9.1pF	±0.1pF	GCM1555C1H9R1BA16#					±5%	GCM1555C1H360JA16#	
				±0.25pF	GCM1555C1H9R1CA16#				39pF	±1%	GCM1555C1H390FA16#	
			±0.5pF	GCM1555C1H9R1DA16#	±2%					GCM1555C1H390GA16#		
			9.2pF	±0.25pF	GCM1555C1H9R2CA16#				±5%	GCM1555C1H390JA16#		
				±0.5pF	GCM1555C1H9R2DA16#				43pF	±1%	GCM1555C1H430FA16#	
			9.3pF	±0.5pF	GCM1555C1H9R3DA16#					±2%	GCM1555C1H430GA16#	
				±0.5pF	GCM1555C1H9R4DA16#					±5%	GCM1555C1H430JA16#	
			9.4pF	±0.5pF	GCM1555C1H9R5DA16#				47pF	±1%	GCM1555C1H470FA16#	
				±0.5pF	GCM1555C1H9R6DA16#					±2%	GCM1555C1H470GA16#	
			9.5pF	±0.5pF	GCM1555C1H9R7DA16#					±5%	GCM1555C1H470JA16#	
				9.6pF	±0.5pF				GCM1555C1H9R8DA16#	51pF	±1%	GCM1555C1H510FA16#
			9.7pF		±0.5pF				GCM1555C1H9R9DA16#		±2%	GCM1555C1H510GA16#
				9.8pF	±0.5pF				GCM1555C1H100FA16#		±5%	GCM1555C1H510JA16#
			9.9pF		±1%				GCM1555C1H100GA16#	56pF	±1%	GCM1555C1H560FA16#
					±2%				GCM1555C1H100RA16#		±2%	GCM1555C1H560GA16#
			±2.5%		GCM1555C1H100RA16#				±5%		GCM1555C1H560JA16#	
			10pF	±5%	GCM1555C1H100JA16#				62pF	±1%	GCM1555C1H620FA16#	
				11pF	±1%					GCM1555C1H110FA16#	±2%	GCM1555C1H620GA16#
					±2%					GCM1555C1H110GA16#	±5%	GCM1555C1H620JA16#
			12pF	±1%	GCM1555C1H110JA16#				68pF	±1%	GCM1555C1H680FA16#	
				±2%	GCM1555C1H120FA16#					±2%	GCM1555C1H680GA16#	
				±5%	GCM1555C1H120JA16#					±5%	GCM1555C1H680JA16#	
			13pF	±1%	GCM1555C1H130FA16#				75pF	±1%	GCM1555C1H750FA16#	
				±2%	GCM1555C1H130GA16#					±2%	GCM1555C1H750GA16#	
				±5%	GCM1555C1H130JA16#					±5%	GCM1555C1H750JA16#	
			15pF	±1%	GCM1555C1H150FA16#				82pF	±1%	GCM1555C1H820FA16#	
				±2%	GCM1555C1H150GA16#					±2%	GCM1555C1H820GA16#	
				±5%	GCM1555C1H150JA16#					±5%	GCM1555C1H820JA16#	
			16pF	±1%	GCM1555C1H160FA16#				91pF	±1%	GCM1555C1H910FA16#	
				±2%	GCM1555C1H160GA16#					±2%	GCM1555C1H910GA16#	
				±5%	GCM1555C1H160JA16#					±5%	GCM1555C1H910JA16#	
			18pF	±1%	GCM1555C1H180FA16#				100pF	±1%	GCM1555C1H101FA16#	
				±2%	GCM1555C1H180GA16#					±2%	GCM1555C1H101GA16#	
				±5%	GCM1555C1H180JA16#					±5%	GCM1555C1H101JA16#	
			20pF	±1%	GCM1555C1H200FA16#				110pF	±1%	GCM1555C1H111FA16#	
				±2%	GCM1555C1H200GA16#					±2%	GCM1555C1H111GA16#	
				±5%	GCM1555C1H200JA16#					±5%	GCM1555C1H111JA16#	
			22pF	±1%	GCM1555C1H220FA16#				120pF	±1%	GCM1555C1H121FA16#	
				±2%	GCM1555C1H220GA16#					±2%	GCM1555C1H121GA16#	
				±5%	GCM1555C1H220JA16#					±5%	GCM1555C1H121JA16#	
			24pF	±1%	GCM1555C1H240FA16#				130pF	±1%	GCM1555C1H131FA16#	
				±2%	GCM1555C1H240GA16#					±2%	GCM1555C1H131GA16#	
				±5%	GCM1555C1H240JA16#					±5%	GCM1555C1H131JA16#	
			27pF	±1%	GCM1555C1H270FA16#				150pF	±1%	GCM1555C1H151FA16#	
				±2%	GCM1555C1H270GA16#					±2%	GCM1555C1H151GA16#	
				±5%	GCM1555C1H270JA16#					±5%	GCM1555C1H151JA16#	
			30pF	±1%	GCM1555C1H300FA16#				160pF	±1%	GCM1555C1H161FA16#	
				±2%	GCM1555C1H300GA16#					±2%	GCM1555C1H161GA16#	
				±5%	GCM1555C1H300JA16#					±5%	GCM1555C1H161JA16#	
			33pF	±1%	GCM1555C1H330FA16#				180pF	±1%	GCM1555C1H181FA16#	
±2%	GCM1555C1H330GA16#	±2%		GCM1555C1H181GA16#								
±5%	GCM1555C1H330JA16#	±5%		GCM1555C1H181JA16#								

Part number # indicates the package specification code.

GRT Series
 GCM Series
 GC3 Series
 GCJ Series
 GCQ Series
 GCD Series
 GCE Series
 NMF Series
 KCM Series
 KC3 Series
 KCA Series
 GCB Series
 GCG Series
 ⚠Caution / Notice

GCM Series Temperature Compensating Type Part Number List

(→ 1.0×0.5mm)

T max.	Rated Voltage	TC Code	Cap.	Tol.	Part Number
0.55mm	50Vdc	COG	200pF	±1%	GCM1555C1H201FA16#
				±2%	GCM1555C1H201GA16#
				±5%	GCM1555C1H201JA16#
			220pF	±1%	GCM1555C1H221FA16#
				±2%	GCM1555C1H221GA16#
				±5%	GCM1555C1H221JA16#
			240pF	±1%	GCM1555C1H241FA16#
				±2%	GCM1555C1H241GA16#
				±5%	GCM1555C1H241JA16#
			270pF	±1%	GCM1555C1H271FA16#
				±2%	GCM1555C1H271GA16#
				±5%	GCM1555C1H271JA16#
			300pF	±1%	GCM1555C1H301FA16#
				±2%	GCM1555C1H301GA16#
				±5%	GCM1555C1H301JA16#
			330pF	±1%	GCM1555C1H331FA16#
				±2%	GCM1555C1H331GA16#
				±5%	GCM1555C1H331JA16#
			360pF	±1%	GCM1555C1H361FA16#
				±2%	GCM1555C1H361GA16#
				±5%	GCM1555C1H361JA16#
			390pF	±1%	GCM1555C1H391FA16#
				±2%	GCM1555C1H391GA16#
				±5%	GCM1555C1H391JA16#
			430pF	±1%	GCM1555C1H431FA16#
				±2%	GCM1555C1H431GA16#
				±5%	GCM1555C1H431JA16#
			470pF	±1%	GCM1555C1H471FA16#
				±2%	GCM1555C1H471GA16#
				±5%	GCM1555C1H471JA16#
			510pF	±1%	GCM1555C1H511FA16#
				±2%	GCM1555C1H511GA16#
				±5%	GCM1555C1H511JA16#
			560pF	±1%	GCM1555C1H561FA16#
				±2%	GCM1555C1H561GA16#
				±5%	GCM1555C1H561JA16#
			620pF	±1%	GCM1555C1H621FA16#
				±2%	GCM1555C1H621GA16#
				±5%	GCM1555C1H621JA16#
			680pF	±1%	GCM1555C1H681FA16#
				±2%	GCM1555C1H681GA16#
				±5%	GCM1555C1H681JA16#
			750pF	±1%	GCM1555C1H751FA16#
				±2%	GCM1555C1H751GA16#
				±5%	GCM1555C1H751JA16#
			820pF	±1%	GCM1555C1H821FA16#
				±2%	GCM1555C1H821GA16#
				±5%	GCM1555C1H821JA16#
			910pF	±1%	GCM1555C1H911FA16#
				±2%	GCM1555C1H911GA16#
				±5%	GCM1555C1H911JA16#
			1000pF	±1%	GCM1555C1H102FA16#
				±2%	GCM1555C1H102GA16#
				±5%	GCM1555C1H102JA16#

T max.	Rated Voltage	TC Code	Cap.	Tol.	Part Number
0.55mm	50Vdc	X8G	0.10pF	±0.1pF	GCM1555G1HR10BA16#
				±0.25pF	GCM1555G1HR10CA16#
			0.20pF	±0.1pF	GCM1555G1HR20BA16#
				±0.25pF	GCM1555G1HR20CA16#
			0.30pF	±0.1pF	GCM1555G1HR30BA16#
				±0.25pF	GCM1555G1HR30CA16#
			0.40pF	±0.1pF	GCM1555G1HR40BA16#
				±0.25pF	GCM1555G1HR40CA16#
			0.50pF	±0.1pF	GCM1555G1HR50BA16#
				±0.25pF	GCM1555G1HR50CA16#
			0.60pF	±0.1pF	GCM1555G1HR60BA16#
				±0.25pF	GCM1555G1HR60CA16#
			0.70pF	±0.1pF	GCM1555G1HR70BA16#
				±0.25pF	GCM1555G1HR70CA16#
			0.75pF	±0.1pF	GCM1555G1HR75BA16#
				±0.25pF	GCM1555G1HR75CA16#
			0.80pF	±0.1pF	GCM1555G1HR80BA16#
				±0.25pF	GCM1555G1HR80CA16#
			0.90pF	±0.1pF	GCM1555G1HR90BA16#
				±0.25pF	GCM1555G1HR90CA16#
			1.0pF	±0.1pF	GCM1555G1H1R0BA16#
				±0.25pF	GCM1555G1H1R0CA16#
			1.1pF	±0.1pF	GCM1555G1H1R1BA16#
				±0.25pF	GCM1555G1H1R1CA16#
			1.2pF	±0.1pF	GCM1555G1H1R2BA16#
				±0.25pF	GCM1555G1H1R2CA16#
			1.3pF	±0.1pF	GCM1555G1H1R3BA16#
				±0.25pF	GCM1555G1H1R3CA16#
			1.4pF	±0.1pF	GCM1555G1H1R4BA16#
				±0.25pF	GCM1555G1H1R4CA16#
			1.5pF	±0.1pF	GCM1555G1H1R5BA16#
				±0.25pF	GCM1555G1H1R5CA16#
			1.6pF	±0.1pF	GCM1555G1H1R6BA16#
				±0.25pF	GCM1555G1H1R6CA16#
			1.7pF	±0.1pF	GCM1555G1H1R7BA16#
				±0.25pF	GCM1555G1H1R7CA16#
			1.8pF	±0.1pF	GCM1555G1H1R8BA16#
				±0.25pF	GCM1555G1H1R8CA16#
			1.9pF	±0.1pF	GCM1555G1H1R9BA16#
				±0.25pF	GCM1555G1H1R9CA16#
			2.0pF	±0.1pF	GCM1555G1H2R0BA16#
				±0.25pF	GCM1555G1H2R0CA16#
2.1pF	±0.1pF	GCM1555G1H2R1BA16#			
	±0.25pF	GCM1555G1H2R1CA16#			
2.2pF	±0.1pF	GCM1555G1H2R2BA16#			
	±0.25pF	GCM1555G1H2R2CA16#			
2.3pF	±0.1pF	GCM1555G1H2R3BA16#			
	±0.25pF	GCM1555G1H2R3CA16#			
2.4pF	±0.1pF	GCM1555G1H2R4BA16#			
	±0.25pF	GCM1555G1H2R4CA16#			
2.5pF	±0.1pF	GCM1555G1H2R5BA16#			
	±0.25pF	GCM1555G1H2R5CA16#			
2.6pF	±0.1pF	GCM1555G1H2R6BA16#			
	±0.25pF	GCM1555G1H2R6CA16#			

GRT Series
 GCM Series
 GC3 Series
 GCJ Series
 GCQ Series
 GCD Series
 GCE Series
 NMF Series
 KCM Series
 KC3 Series
 KCA Series
 GCB Series
 GCG Series
 ⚠Caution /Notice

Part number # indicates the package specification code.

GCM Series Temperature Compensating Type Part Number List

(→ 1.0×0.5mm)

T max.	Rated Voltage	TC Code	Cap.	Tol.	Part Number	T max.	Rated Voltage	TC Code	Cap.	Tol.	Part Number
0.55mm	50Vdc	X8G	2.7pF	±0.1pF	GCM1555G1H2R7BA16#	0.55mm	50Vdc	X8G	5.4pF	±0.1pF	GCM1555G1H5R4BA16#
				±0.25pF	GCM1555G1H2R7CA16#					±0.25pF	GCM1555G1H5R4CA16#
			2.8pF	±0.1pF	GCM1555G1H2R8BA16#				5.5pF	±0.1pF	GCM1555G1H5R5BA16#
				±0.25pF	GCM1555G1H2R8CA16#					±0.25pF	GCM1555G1H5R5CA16#
			2.9pF	±0.1pF	GCM1555G1H2R9BA16#				5.6pF	±0.1pF	GCM1555G1H5R6BA16#
				±0.25pF	GCM1555G1H2R9CA16#					±0.25pF	GCM1555G1H5R6CA16#
			3.0pF	±0.1pF	GCM1555G1H3R0BA16#				5.7pF	±0.1pF	GCM1555G1H5R7BA16#
				±0.25pF	GCM1555G1H3R0CA16#					±0.25pF	GCM1555G1H5R7CA16#
			3.1pF	±0.1pF	GCM1555G1H3R1BA16#				5.8pF	±0.1pF	GCM1555G1H5R8BA16#
				±0.25pF	GCM1555G1H3R1CA16#					±0.25pF	GCM1555G1H5R8CA16#
			3.2pF	±0.1pF	GCM1555G1H3R2BA16#				5.9pF	±0.1pF	GCM1555G1H5R9BA16#
				±0.25pF	GCM1555G1H3R2CA16#					±0.25pF	GCM1555G1H5R9CA16#
			3.3pF	±0.1pF	GCM1555G1H3R3BA16#				6.0pF	±0.1pF	GCM1555G1H6R0BA16#
				±0.25pF	GCM1555G1H3R3CA16#					±0.25pF	GCM1555G1H6R0CA16#
			3.4pF	±0.1pF	GCM1555G1H3R4BA16#				6.1pF	±0.1pF	GCM1555G1H6R1BA16#
				±0.25pF	GCM1555G1H3R4CA16#					±0.25pF	GCM1555G1H6R1CA16#
			3.5pF	±0.1pF	GCM1555G1H3R5BA16#				6.2pF	±0.1pF	GCM1555G1H6R2BA16#
				±0.25pF	GCM1555G1H3R5CA16#					±0.25pF	GCM1555G1H6R2CA16#
			3.6pF	±0.1pF	GCM1555G1H3R6BA16#				6.3pF	±0.1pF	GCM1555G1H6R3BA16#
				±0.25pF	GCM1555G1H3R6CA16#					±0.25pF	GCM1555G1H6R3CA16#
			3.7pF	±0.1pF	GCM1555G1H3R7BA16#				6.4pF	±0.1pF	GCM1555G1H6R4BA16#
				±0.25pF	GCM1555G1H3R7CA16#					±0.25pF	GCM1555G1H6R4CA16#
			3.8pF	±0.1pF	GCM1555G1H3R8BA16#				6.5pF	±0.1pF	GCM1555G1H6R5BA16#
				±0.25pF	GCM1555G1H3R8CA16#					±0.25pF	GCM1555G1H6R5CA16#
			3.9pF	±0.1pF	GCM1555G1H3R9BA16#				6.6pF	±0.1pF	GCM1555G1H6R6BA16#
				±0.25pF	GCM1555G1H3R9CA16#					±0.25pF	GCM1555G1H6R6CA16#
			4.0pF	±0.1pF	GCM1555G1H4R0BA16#				6.7pF	±0.1pF	GCM1555G1H6R7BA16#
				±0.25pF	GCM1555G1H4R0CA16#					±0.25pF	GCM1555G1H6R7CA16#
			4.1pF	±0.1pF	GCM1555G1H4R1BA16#				6.8pF	±0.1pF	GCM1555G1H6R8BA16#
				±0.25pF	GCM1555G1H4R1CA16#					±0.25pF	GCM1555G1H6R8CA16#
			4.2pF	±0.1pF	GCM1555G1H4R2BA16#				6.9pF	±0.1pF	GCM1555G1H6R9BA16#
				±0.25pF	GCM1555G1H4R2CA16#					±0.25pF	GCM1555G1H6R9CA16#
			4.3pF	±0.1pF	GCM1555G1H4R3BA16#				7.0pF	±0.1pF	GCM1555G1H7R0BA16#
				±0.25pF	GCM1555G1H4R3CA16#					±0.25pF	GCM1555G1H7R0CA16#
			4.4pF	±0.1pF	GCM1555G1H4R4BA16#				7.1pF	±0.1pF	GCM1555G1H7R1BA16#
				±0.25pF	GCM1555G1H4R4CA16#					±0.25pF	GCM1555G1H7R1CA16#
			4.5pF	±0.1pF	GCM1555G1H4R5BA16#				7.2pF	±0.1pF	GCM1555G1H7R2BA16#
				±0.25pF	GCM1555G1H4R5CA16#					±0.25pF	GCM1555G1H7R2CA16#
			4.6pF	±0.1pF	GCM1555G1H4R6BA16#				7.3pF	±0.1pF	GCM1555G1H7R3BA16#
				±0.25pF	GCM1555G1H4R6CA16#					±0.25pF	GCM1555G1H7R3CA16#
			4.7pF	±0.1pF	GCM1555G1H4R7BA16#				7.4pF	±0.1pF	GCM1555G1H7R4BA16#
				±0.25pF	GCM1555G1H4R7CA16#					±0.25pF	GCM1555G1H7R4CA16#
4.8pF	±0.1pF	GCM1555G1H4R8BA16#	7.5pF	±0.1pF	GCM1555G1H7R5BA16#						
	±0.25pF	GCM1555G1H4R8CA16#		±0.25pF	GCM1555G1H7R5CA16#						
4.9pF	±0.1pF	GCM1555G1H4R9BA16#	7.6pF	±0.1pF	GCM1555G1H7R6BA16#						
	±0.25pF	GCM1555G1H4R9CA16#		±0.25pF	GCM1555G1H7R6CA16#						
5.0pF	±0.1pF	GCM1555G1H5R0BA16#	7.7pF	±0.1pF	GCM1555G1H7R7BA16#						
	±0.25pF	GCM1555G1H5R0CA16#		±0.25pF	GCM1555G1H7R7CA16#						
5.1pF	±0.1pF	GCM1555G1H5R1BA16#	7.8pF	±0.1pF	GCM1555G1H7R8BA16#						
	±0.25pF	GCM1555G1H5R1CA16#		±0.25pF	GCM1555G1H7R8CA16#						
5.2pF	±0.1pF	GCM1555G1H5R2BA16#	7.9pF	±0.1pF	GCM1555G1H7R9BA16#						
	±0.25pF	GCM1555G1H5R2CA16#		±0.25pF	GCM1555G1H7R9CA16#						
5.3pF	±0.1pF	GCM1555G1H5R3BA16#	8.0pF	±0.1pF	GCM1555G1H8R0BA16#						
	±0.25pF	GCM1555G1H5R3CA16#		±0.25pF	GCM1555G1H8R0CA16#						

GRT Series
 GCM Series
 GC3 Series
 GCJ Series
 GCQ Series
 GCD Series
 GCE Series
 NMF Series
 KCM Series
 KC3 Series
 KCA Series
 GCB Series
 GCG Series
 ⚠Caution /Notice

Part number # indicates the package specification code.

GCM Series Temperature Compensating Type Part Number List

(→ 1.0×0.5mm)

T max.	Rated Voltage	TC Code	Cap.	Tol.	Part Number
0.55mm	50Vdc	X8G	8.1pF	±0.1pF	GCM1555G1H8R1BA16#
				±0.25pF	GCM1555G1H8R1CA16#
			8.2pF	±0.1pF	GCM1555G1H8R2BA16#
				±0.25pF	GCM1555G1H8R2CA16#
			8.3pF	±0.1pF	GCM1555G1H8R3BA16#
				±0.25pF	GCM1555G1H8R3CA16#
			8.4pF	±0.1pF	GCM1555G1H8R4BA16#
				±0.25pF	GCM1555G1H8R4CA16#
			8.5pF	±0.1pF	GCM1555G1H8R5BA16#
				±0.25pF	GCM1555G1H8R5CA16#
			8.6pF	±0.1pF	GCM1555G1H8R6BA16#
				±0.25pF	GCM1555G1H8R6CA16#
			8.7pF	±0.1pF	GCM1555G1H8R7BA16#
				±0.25pF	GCM1555G1H8R7CA16#
			8.8pF	±0.1pF	GCM1555G1H8R8BA16#
				±0.25pF	GCM1555G1H8R8CA16#
			8.9pF	±0.1pF	GCM1555G1H8R9BA16#
				±0.25pF	GCM1555G1H8R9CA16#
			9.0pF	±0.1pF	GCM1555G1H9R0BA16#
				±0.25pF	GCM1555G1H9R0CA16#
			9.1pF	±0.1pF	GCM1555G1H9R1BA16#
				±0.25pF	GCM1555G1H9R1CA16#
			9.2pF	±0.1pF	GCM1555G1H9R2BA16#
				±0.25pF	GCM1555G1H9R2CA16#
			9.3pF	±0.1pF	GCM1555G1H9R3BA16#
				±0.25pF	GCM1555G1H9R3CA16#
			9.4pF	±0.1pF	GCM1555G1H9R4BA16#
				±0.25pF	GCM1555G1H9R4CA16#
			9.5pF	±0.1pF	GCM1555G1H9R5BA16#
				±0.25pF	GCM1555G1H9R5CA16#
			9.6pF	±0.1pF	GCM1555G1H9R6BA16#
				±0.25pF	GCM1555G1H9R6CA16#
			9.7pF	±0.1pF	GCM1555G1H9R7BA16#
				±0.25pF	GCM1555G1H9R7CA16#
			9.8pF	±0.1pF	GCM1555G1H9R8BA16#
				±0.25pF	GCM1555G1H9R8CA16#
			9.9pF	±0.1pF	GCM1555G1H9R9BA16#
				±0.25pF	GCM1555G1H9R9CA16#
			10pF	±1%	GCM1555G1H100FA16#
				±2%	GCM1555G1H100GA16#
				±2.5%	GCM1555G1H100RA16#
				±5%	GCM1555G1H100JA16#
			11pF	±1%	GCM1555G1H110FA16#
				±2%	GCM1555G1H110GA16#
				±5%	GCM1555G1H110JA16#
			12pF	±1%	GCM1555G1H120FA16#
				±2%	GCM1555G1H120GA16#
				±5%	GCM1555G1H120JA16#
			13pF	±1%	GCM1555G1H130FA16#
				±2%	GCM1555G1H130GA16#
				±5%	GCM1555G1H130JA16#
			15pF	±1%	GCM1555G1H150FA16#
				±2%	GCM1555G1H150GA16#
				±5%	GCM1555G1H150JA16#

T max.	Rated Voltage	TC Code	Cap.	Tol.	Part Number
0.55mm	50Vdc	X8G	16pF	±1%	GCM1555G1H160FA16#
				±2%	GCM1555G1H160GA16#
				±5%	GCM1555G1H160JA16#
			18pF	±1%	GCM1555G1H180FA16#
				±2%	GCM1555G1H180GA16#
				±5%	GCM1555G1H180JA16#
			20pF	±1%	GCM1555G1H200FA16#
				±2%	GCM1555G1H200GA16#
				±5%	GCM1555G1H200JA16#
			22pF	±1%	GCM1555G1H220FA16#
				±2%	GCM1555G1H220GA16#
				±5%	GCM1555G1H220JA16#
			24pF	±1%	GCM1555G1H240FA16#
				±2%	GCM1555G1H240GA16#
				±5%	GCM1555G1H240JA16#
			27pF	±1%	GCM1555G1H270FA16#
				±2%	GCM1555G1H270GA16#
				±5%	GCM1555G1H270JA16#
			30pF	±1%	GCM1555G1H300FA16#
				±2%	GCM1555G1H300GA16#
				±5%	GCM1555G1H300JA16#
			33pF	±1%	GCM1555G1H330FA16#
				±2%	GCM1555G1H330GA16#
				±5%	GCM1555G1H330JA16#
			36pF	±1%	GCM1555G1H360FA16#
				±2%	GCM1555G1H360GA16#
				±5%	GCM1555G1H360JA16#
			39pF	±1%	GCM1555G1H390FA16#
				±2%	GCM1555G1H390GA16#
				±5%	GCM1555G1H390JA16#
			43pF	±1%	GCM1555G1H430FA16#
				±2%	GCM1555G1H430GA16#
				±5%	GCM1555G1H430JA16#
			47pF	±1%	GCM1555G1H470FA16#
				±2%	GCM1555G1H470GA16#
				±5%	GCM1555G1H470JA16#
			51pF	±1%	GCM1555G1H510FA16#
				±2%	GCM1555G1H510GA16#
				±5%	GCM1555G1H510JA16#
			56pF	±1%	GCM1555G1H560FA16#
				±2%	GCM1555G1H560GA16#
				±5%	GCM1555G1H560JA16#
			62pF	±1%	GCM1555G1H620FA16#
				±2%	GCM1555G1H620GA16#
				±5%	GCM1555G1H620JA16#
			68pF	±1%	GCM1555G1H680FA16#
				±2%	GCM1555G1H680GA16#
				±5%	GCM1555G1H680JA16#
75pF	±1%	GCM1555G1H750FA16#			
	±2%	GCM1555G1H750GA16#			
	±5%	GCM1555G1H750JA16#			
82pF	±1%	GCM1555G1H820FA16#			
	±2%	GCM1555G1H820GA16#			
	±5%	GCM1555G1H820JA16#			

Part number # indicates the package specification code.

GRT Series
 GCM Series
 GC3 Series
 GCJ Series
 GCQ Series
 GCD Series
 GCE Series
 NMF Series
 KCM Series
 KC3 Series
 KCA Series
 GCB Series
 GCG Series
 ⚠Caution /Notice

GCM Series Temperature Compensating Type Part Number List

(→ 1.0×0.5mm)

T max.	Rated Voltage	TC Code	Cap.	Tol.	Part Number
0.55mm	50Vdc	X8G	91pF	±1%	GCM1555G1H910FA16#
				±2%	GCM1555G1H910GA16#
				±5%	GCM1555G1H910JA16#
			100pF	±1%	GCM1555G1H101FA16#
				±2%	GCM1555G1H101GA16#
				±5%	GCM1555G1H101JA16#
			110pF	±1%	GCM1555G1H111FA16#
				±2%	GCM1555G1H111GA16#
				±5%	GCM1555G1H111JA16#
			120pF	±1%	GCM1555G1H121FA16#
				±2%	GCM1555G1H121GA16#
				±5%	GCM1555G1H121JA16#
			130pF	±1%	GCM1555G1H131FA16#
				±2%	GCM1555G1H131GA16#
				±5%	GCM1555G1H131JA16#
			150pF	±1%	GCM1555G1H151FA16#
				±2%	GCM1555G1H151GA16#
				±5%	GCM1555G1H151JA16#
			160pF	±1%	GCM1555G1H161FA16#
				±2%	GCM1555G1H161GA16#
				±5%	GCM1555G1H161JA16#
			180pF	±1%	GCM1555G1H181FA16#
				±2%	GCM1555G1H181GA16#
				±5%	GCM1555G1H181JA16#
			200pF	±1%	GCM1555G1H201FA16#
				±2%	GCM1555G1H201GA16#
				±5%	GCM1555G1H201JA16#
			220pF	±1%	GCM1555G1H221FA16#
				±2%	GCM1555G1H221GA16#
				±5%	GCM1555G1H221JA16#
			240pF	±1%	GCM1555G1H241FA16#
				±2%	GCM1555G1H241GA16#
				±5%	GCM1555G1H241JA16#
			270pF	±1%	GCM1555G1H271FA16#
				±2%	GCM1555G1H271GA16#
				±5%	GCM1555G1H271JA16#
			300pF	±1%	GCM1555G1H301FA16#
				±2%	GCM1555G1H301GA16#
				±5%	GCM1555G1H301JA16#
			330pF	±1%	GCM1555G1H331FA16#
				±2%	GCM1555G1H331GA16#
				±5%	GCM1555G1H331JA16#
			360pF	±1%	GCM1555G1H361FA16#
				±2%	GCM1555G1H361GA16#
				±5%	GCM1555G1H361JA16#
			390pF	±1%	GCM1555G1H391FA16#
				±2%	GCM1555G1H391GA16#
				±5%	GCM1555G1H391JA16#
			430pF	±1%	GCM1555G1H431FA16#
				±2%	GCM1555G1H431GA16#
				±5%	GCM1555G1H431JA16#
			470pF	±1%	GCM1555G1H471FA16#
				±2%	GCM1555G1H471GA16#
				±5%	GCM1555G1H471JA16#

T max.	Rated Voltage	TC Code	Cap.	Tol.	Part Number
0.55mm	50Vdc	X8G	510pF	±1%	GCM1555G1H511FA16#
				±2%	GCM1555G1H511GA16#
				±5%	GCM1555G1H511JA16#
			560pF	±1%	GCM1555G1H561FA16#
				±2%	GCM1555G1H561GA16#
				±5%	GCM1555G1H561JA16#
			620pF	±1%	GCM1555G1H621FA16#
				±2%	GCM1555G1H621GA16#
				±5%	GCM1555G1H621JA16#
			680pF	±1%	GCM1555G1H681FA16#
				±2%	GCM1555G1H681GA16#
				±5%	GCM1555G1H681JA16#
			750pF	±1%	GCM1555G1H751FA16#
				±2%	GCM1555G1H751GA16#
				±5%	GCM1555G1H751JA16#
			820pF	±1%	GCM1555G1H821FA16#
				±2%	GCM1555G1H821GA16#
				±5%	GCM1555G1H821JA16#
			910pF	±1%	GCM1555G1H911FA16#
				±2%	GCM1555G1H911GA16#
				±5%	GCM1555G1H911JA16#
			1000pF	±1%	GCM1555G1H102FA16#
				±2%	GCM1555G1H102GA16#
				±5%	GCM1555G1H102JA16#

1.6×0.8mm

T max.	Rated Voltage	TC Code	Cap.	Tol.	Part Number
0.9mm	100Vdc	COG	0.47pF	±0.1pF	GCM1885C2AR47BA16#
				±0.25pF	GCM1885C2AR47CA16#
			0.50pF	±0.1pF	GCM1885C2AR50BA16#
				±0.25pF	GCM1885C2AR50CA16#
			0.51pF	±0.1pF	GCM1885C2AR51BA16#
				±0.25pF	GCM1885C2AR51CA16#
			0.56pF	±0.1pF	GCM1885C2AR56BA16#
				±0.25pF	GCM1885C2AR56CA16#
			0.60pF	±0.1pF	GCM1885C2AR60BA16#
				±0.25pF	GCM1885C2AR60CA16#
			0.62pF	±0.1pF	GCM1885C2AR62BA16#
				±0.25pF	GCM1885C2AR62CA16#
			0.68pF	±0.1pF	GCM1885C2AR68BA16#
				±0.25pF	GCM1885C2AR68CA16#
			0.70pF	±0.1pF	GCM1885C2AR70BA16#
				±0.25pF	GCM1885C2AR70CA16#
			0.75pF	±0.1pF	GCM1885C2AR75BA16#
				±0.25pF	GCM1885C2AR75CA16#
			0.80pF	±0.1pF	GCM1885C2AR80BA16#
				±0.25pF	GCM1885C2AR80CA16#
			0.82pF	±0.1pF	GCM1885C2AR82BA16#
				±0.25pF	GCM1885C2AR82CA16#
			0.90pF	±0.1pF	GCM1885C2AR90BA16#
				±0.25pF	GCM1885C2AR90CA16#
			0.91pF	±0.1pF	GCM1885C2AR91BA16#

Part number # indicates the package specification code.

GRT Series
 GCM Series
 GC3 Series
 GCJ Series
 GCQ Series
 GCD Series
 GCE Series
 NMF Series
 KCM Series
 KC3 Series
 KCA Series
 GCB Series
 GCG Series
 ⚠Caution /Notice

GCM Series Temperature Compensating Type Part Number List

(→ 1.6×0.8mm)

T max.	Rated Voltage	TC Code	Cap.	Tol.	Part Number	T max.	Rated Voltage	TC Code	Cap.	Tol.	Part Number
0.9mm	100Vdc	COG	0.91pF	±0.25pF	GCM1885C2AR91CA16#	0.9mm	100Vdc	COG	3.6pF	±0.25pF	GCM1885C2A3R6CA16#
				±0.1pF	GCM1885C2A1R0BA16#					±0.1pF	GCM1885C2A3R7BA16#
			±0.25pF	GCM1885C2A1R0CA16#	±0.25pF				GCM1885C2A3R7CA16#		
			1.1pF	±0.1pF	GCM1885C2A1R1BA16#				3.8pF	±0.1pF	GCM1885C2A3R8BA16#
				±0.25pF	GCM1885C2A1R1CA16#					±0.25pF	GCM1885C2A3R8CA16#
			1.2pF	±0.1pF	GCM1885C2A1R2BA16#				3.9pF	±0.1pF	GCM1885C2A3R9BA16#
				±0.25pF	GCM1885C2A1R2CA16#					±0.25pF	GCM1885C2A3R9CA16#
			1.3pF	±0.1pF	GCM1885C2A1R3BA16#				4.0pF	±0.1pF	GCM1885C2A4R0BA16#
				±0.25pF	GCM1885C2A1R3CA16#					±0.25pF	GCM1885C2A4R0CA16#
			1.4pF	±0.1pF	GCM1885C2A1R4BA16#					±0.5pF	GCM1885C2A4R0DA16#
				±0.25pF	GCM1885C2A1R4CA16#				4.1pF	±0.1pF	GCM1885C2A4R1BA16#
			1.5pF	±0.1pF	GCM1885C2A1R5BA16#					±0.25pF	GCM1885C2A4R1CA16#
				±0.25pF	GCM1885C2A1R5CA16#					±0.5pF	GCM1885C2A4R1DA16#
			1.6pF	±0.1pF	GCM1885C2A1R6BA16#				4.2pF	±0.1pF	GCM1885C2A4R2BA16#
				±0.25pF	GCM1885C2A1R6CA16#					±0.25pF	GCM1885C2A4R2CA16#
			1.7pF	±0.1pF	GCM1885C2A1R7BA16#					±0.5pF	GCM1885C2A4R2DA16#
				±0.25pF	GCM1885C2A1R7CA16#				4.3pF	±0.1pF	GCM1885C2A4R3BA16#
			1.8pF	±0.1pF	GCM1885C2A1R8BA16#					±0.25pF	GCM1885C2A4R3CA16#
				±0.25pF	GCM1885C2A1R8CA16#					±0.5pF	GCM1885C2A4R3DA16#
			1.9pF	±0.1pF	GCM1885C2A1R9BA16#				4.4pF	±0.1pF	GCM1885C2A4R4BA16#
				±0.25pF	GCM1885C2A1R9CA16#					±0.25pF	GCM1885C2A4R4CA16#
			2.0pF	±0.1pF	GCM1885C2A2R0BA16#					±0.5pF	GCM1885C2A4R4DA16#
				±0.25pF	GCM1885C2A2R0CA16#				4.5pF	±0.1pF	GCM1885C2A4R5BA16#
			2.1pF	±0.1pF	GCM1885C2A2R1BA16#					±0.25pF	GCM1885C2A4R5CA16#
				±0.25pF	GCM1885C2A2R1CA16#					±0.5pF	GCM1885C2A4R5DA16#
			2.2pF	±0.1pF	GCM1885C2A2R2BA16#				4.6pF	±0.1pF	GCM1885C2A4R6BA16#
				±0.25pF	GCM1885C2A2R2CA16#					±0.25pF	GCM1885C2A4R6CA16#
			2.3pF	±0.1pF	GCM1885C2A2R3BA16#					±0.5pF	GCM1885C2A4R6DA16#
				±0.25pF	GCM1885C2A2R3CA16#				4.7pF	±0.1pF	GCM1885C2A4R7BA16#
			2.4pF	±0.1pF	GCM1885C2A2R4BA16#					±0.25pF	GCM1885C2A4R7CA16#
				±0.25pF	GCM1885C2A2R4CA16#					±0.5pF	GCM1885C2A4R7DA16#
			2.5pF	±0.1pF	GCM1885C2A2R5BA16#				4.8pF	±0.1pF	GCM1885C2A4R8BA16#
				±0.25pF	GCM1885C2A2R5CA16#					±0.25pF	GCM1885C2A4R8CA16#
			2.6pF	±0.1pF	GCM1885C2A2R6BA16#					±0.5pF	GCM1885C2A4R8DA16#
				±0.25pF	GCM1885C2A2R6CA16#				4.9pF	±0.1pF	GCM1885C2A4R9BA16#
			2.7pF	±0.1pF	GCM1885C2A2R7BA16#					±0.25pF	GCM1885C2A4R9CA16#
				±0.25pF	GCM1885C2A2R7CA16#					±0.5pF	GCM1885C2A4R9DA16#
			2.8pF	±0.1pF	GCM1885C2A2R8BA16#				5.0pF	±0.1pF	GCM1885C2A5R0BA16#
				±0.25pF	GCM1885C2A2R8CA16#					±0.25pF	GCM1885C2A5R0CA16#
			2.9pF	±0.1pF	GCM1885C2A2R9BA16#					±0.5pF	GCM1885C2A5R0DA16#
				±0.25pF	GCM1885C2A2R9CA16#				5.1pF	±0.1pF	GCM1885C2A5R1BA16#
			3.0pF	±0.1pF	GCM1885C2A3R0BA16#					±0.25pF	GCM1885C2A5R1CA16#
				±0.25pF	GCM1885C2A3R0CA16#					±0.5pF	GCM1885C2A5R1DA16#
			3.1pF	±0.1pF	GCM1885C2A3R1BA16#				5.2pF	±0.1pF	GCM1885C2A5R2BA16#
				±0.25pF	GCM1885C2A3R1CA16#					±0.25pF	GCM1885C2A5R2CA16#
			3.2pF	±0.1pF	GCM1885C2A3R2BA16#					±0.5pF	GCM1885C2A5R2DA16#
				±0.25pF	GCM1885C2A3R2CA16#				5.3pF	±0.1pF	GCM1885C2A5R3BA16#
			3.3pF	±0.1pF	GCM1885C2A3R3BA16#					±0.25pF	GCM1885C2A5R3CA16#
±0.25pF	GCM1885C2A3R3CA16#	±0.5pF		GCM1885C2A5R3DA16#							
3.4pF	±0.1pF	GCM1885C2A3R4BA16#	5.4pF	±0.1pF	GCM1885C2A5R4BA16#						
	±0.25pF	GCM1885C2A3R4CA16#		±0.25pF	GCM1885C2A5R4CA16#						
3.5pF	±0.1pF	GCM1885C2A3R5BA16#		±0.5pF	GCM1885C2A5R4DA16#						
	±0.25pF	GCM1885C2A3R5CA16#	5.5pF	±0.1pF	GCM1885C2A5R5BA16#						
3.6pF	±0.1pF	GCM1885C2A3R6BA16#		±0.25pF	GCM1885C2A5R5CA16#						

GRT Series
 GCM Series
 GC3 Series
 GCJ Series
 GCQ Series
 GCD Series
 GCE Series
 NMF Series
 KCM Series
 KC3 Series
 KCA Series
 GCB Series
 GCG Series
 ⚠Caution /Notice

Part number # indicates the package specification code.

GCM Series Temperature Compensating Type Part Number List

(→ 1.6×0.8mm)

T max.	Rated Voltage	TC Code	Cap.	Tol.	Part Number	T max.	Rated Voltage	TC Code	Cap.	Tol.	Part Number
0.9mm	100Vdc	COG	5.5pF	±0.5pF	GCM1885C2A5R5DA16#	0.9mm	100Vdc	COG	7.3pF	±0.5pF	GCM1885C2A7R3DA16#
				±0.1pF	GCM1885C2A5R6BA16#					±0.1pF	GCM1885C2A7R4BA16#
					±0.25pF						GCM1885C2A5R6CA16#
			±0.5pF	GCM1885C2A5R6DA16#	±0.5pF				GCM1885C2A7R4DA16#		
			5.7pF	±0.1pF	GCM1885C2A5R7BA16#				7.5pF	±0.1pF	GCM1885C2A7R5BA16#
				±0.25pF	GCM1885C2A5R7CA16#					±0.25pF	GCM1885C2A7R5CA16#
				±0.5pF	GCM1885C2A5R7DA16#					±0.5pF	GCM1885C2A7R5DA16#
			5.8pF	±0.1pF	GCM1885C2A5R8BA16#				7.6pF	±0.1pF	GCM1885C2A7R6BA16#
				±0.25pF	GCM1885C2A5R8CA16#					±0.25pF	GCM1885C2A7R6CA16#
				±0.5pF	GCM1885C2A5R8DA16#					±0.5pF	GCM1885C2A7R6DA16#
			5.9pF	±0.1pF	GCM1885C2A5R9BA16#				7.7pF	±0.1pF	GCM1885C2A7R7BA16#
				±0.25pF	GCM1885C2A5R9CA16#					±0.25pF	GCM1885C2A7R7CA16#
				±0.5pF	GCM1885C2A5R9DA16#					±0.5pF	GCM1885C2A7R7DA16#
			6.0pF	±0.1pF	GCM1885C2A6R0BA16#				7.8pF	±0.1pF	GCM1885C2A7R8BA16#
				±0.25pF	GCM1885C2A6R0CA16#					±0.25pF	GCM1885C2A7R8CA16#
				±0.5pF	GCM1885C2A6R0DA16#					±0.5pF	GCM1885C2A7R8DA16#
			6.1pF	±0.1pF	GCM1885C2A6R1BA16#				7.9pF	±0.1pF	GCM1885C2A7R9BA16#
				±0.25pF	GCM1885C2A6R1CA16#					±0.25pF	GCM1885C2A7R9CA16#
				±0.5pF	GCM1885C2A6R1DA16#					±0.5pF	GCM1885C2A7R9DA16#
			6.2pF	±0.1pF	GCM1885C2A6R2BA16#				8.0pF	±0.1pF	GCM1885C2A8R0BA16#
				±0.25pF	GCM1885C2A6R2CA16#					±0.25pF	GCM1885C2A8R0CA16#
				±0.5pF	GCM1885C2A6R2DA16#					±0.5pF	GCM1885C2A8R0DA16#
			6.3pF	±0.1pF	GCM1885C2A6R3BA16#				8.1pF	±0.1pF	GCM1885C2A8R1BA16#
				±0.25pF	GCM1885C2A6R3CA16#					±0.25pF	GCM1885C2A8R1CA16#
				±0.5pF	GCM1885C2A6R3DA16#					±0.5pF	GCM1885C2A8R1DA16#
			6.4pF	±0.1pF	GCM1885C2A6R4BA16#				8.2pF	±0.1pF	GCM1885C2A8R2BA16#
				±0.25pF	GCM1885C2A6R4CA16#					±0.25pF	GCM1885C2A8R2CA16#
				±0.5pF	GCM1885C2A6R4DA16#					±0.5pF	GCM1885C2A8R2DA16#
			6.5pF	±0.1pF	GCM1885C2A6R5BA16#				8.3pF	±0.1pF	GCM1885C2A8R3BA16#
				±0.25pF	GCM1885C2A6R5CA16#					±0.25pF	GCM1885C2A8R3CA16#
				±0.5pF	GCM1885C2A6R5DA16#					±0.5pF	GCM1885C2A8R3DA16#
			6.6pF	±0.1pF	GCM1885C2A6R6BA16#				8.4pF	±0.1pF	GCM1885C2A8R4BA16#
				±0.25pF	GCM1885C2A6R6CA16#					±0.25pF	GCM1885C2A8R4CA16#
				±0.5pF	GCM1885C2A6R6DA16#					±0.5pF	GCM1885C2A8R4DA16#
			6.7pF	±0.1pF	GCM1885C2A6R7BA16#				8.5pF	±0.1pF	GCM1885C2A8R5BA16#
				±0.25pF	GCM1885C2A6R7CA16#					±0.25pF	GCM1885C2A8R5CA16#
				±0.5pF	GCM1885C2A6R7DA16#					±0.5pF	GCM1885C2A8R5DA16#
			6.8pF	±0.1pF	GCM1885C2A6R8BA16#				8.6pF	±0.1pF	GCM1885C2A8R6BA16#
				±0.25pF	GCM1885C2A6R8CA16#					±0.25pF	GCM1885C2A8R6CA16#
				±0.5pF	GCM1885C2A6R8DA16#					±0.5pF	GCM1885C2A8R6DA16#
			6.9pF	±0.1pF	GCM1885C2A6R9BA16#				8.7pF	±0.1pF	GCM1885C2A8R7BA16#
				±0.25pF	GCM1885C2A6R9CA16#					±0.25pF	GCM1885C2A8R7CA16#
±0.5pF	GCM1885C2A6R9DA16#	±0.5pF		GCM1885C2A8R7DA16#							
7.0pF	±0.1pF	GCM1885C2A7R0BA16#	8.8pF	±0.1pF	GCM1885C2A8R8BA16#						
	±0.25pF	GCM1885C2A7R0CA16#		±0.25pF	GCM1885C2A8R8CA16#						
	±0.5pF	GCM1885C2A7R0DA16#		±0.5pF	GCM1885C2A8R8DA16#						
7.1pF	±0.1pF	GCM1885C2A7R1BA16#	8.9pF	±0.1pF	GCM1885C2A8R9BA16#						
	±0.25pF	GCM1885C2A7R1CA16#		±0.25pF	GCM1885C2A8R9CA16#						
	±0.5pF	GCM1885C2A7R1DA16#		±0.5pF	GCM1885C2A8R9DA16#						
7.2pF	±0.1pF	GCM1885C2A7R2BA16#	9.0pF	±0.1pF	GCM1885C2A9R0BA16#						
	±0.25pF	GCM1885C2A7R2CA16#		±0.25pF	GCM1885C2A9R0CA16#						
	±0.5pF	GCM1885C2A7R2DA16#		±0.5pF	GCM1885C2A9R0DA16#						
7.3pF	±0.1pF	GCM1885C2A7R3BA16#	9.1pF	±0.1pF	GCM1885C2A9R1BA16#						
	±0.25pF	GCM1885C2A7R3CA16#		±0.25pF	GCM1885C2A9R1CA16#						

Part number # indicates the package specification code.

GRT Series
 GCM Series
 GC3 Series
 GCJ Series
 GCQ Series
 GCD Series
 GCE Series
 NMF Series
 KCM Series
 KC3 Series
 KCA Series
 GCB Series
 GCG Series
 ⚠Caution /Notice

GCM Series Temperature Compensating Type Part Number List

(→ 1.6×0.8mm)

T max.	Rated Voltage	TC Code	Cap.	Tol.	Part Number	T max.	Rated Voltage	TC Code	Cap.	Tol.	Part Number
0.9mm	100Vdc	COG	9.1pF	±0.5pF	GCM1885C2A9R1DA16#	0.9mm	100Vdc	COG	24pF	±2%	GCM1885C2A240GA16#
				±0.1pF	GCM1885C2A9R2BA16#					±5%	GCM1885C2A240JA16#
				±0.25pF	GCM1885C2A9R2CA16#					27pF	±1%
			±0.5pF	GCM1885C2A9R2DA16#	±2%				GCM1885C2A270GA16#		
			9.3pF	±0.1pF	GCM1885C2A9R3BA16#				30pF	±1%	GCM1885C2A300FA16#
				±0.25pF	GCM1885C2A9R3CA16#					±2%	GCM1885C2A300GA16#
				±0.5pF	GCM1885C2A9R3DA16#					±5%	GCM1885C2A270JA16#
			9.4pF	±0.1pF	GCM1885C2A9R4BA16#				33pF	±1%	GCM1885C2A330FA16#
				±0.25pF	GCM1885C2A9R4CA16#					±2%	GCM1885C2A330GA16#
				±0.5pF	GCM1885C2A9R4DA16#					±5%	GCM1885C2A330JA16#
			9.5pF	±0.1pF	GCM1885C2A9R5BA16#				36pF	±1%	GCM1885C2A360FA16#
				±0.25pF	GCM1885C2A9R5CA16#					±2%	GCM1885C2A360GA16#
				±0.5pF	GCM1885C2A9R5DA16#					±5%	GCM1885C2A360JA16#
			9.6pF	±0.1pF	GCM1885C2A9R6BA16#				39pF	±1%	GCM1885C2A390FA16#
				±0.25pF	GCM1885C2A9R6CA16#					±2%	GCM1885C2A390GA16#
				±0.5pF	GCM1885C2A9R6DA16#					±5%	GCM1885C2A390JA16#
			9.7pF	±0.1pF	GCM1885C2A9R7BA16#				43pF	±1%	GCM1885C2A430FA16#
				±0.25pF	GCM1885C2A9R7CA16#					±2%	GCM1885C2A430GA16#
				±0.5pF	GCM1885C2A9R7DA16#					±5%	GCM1885C2A430JA16#
			9.8pF	±0.1pF	GCM1885C2A9R8BA16#				47pF	±1%	GCM1885C2A470FA16#
				±0.25pF	GCM1885C2A9R8CA16#					±2%	GCM1885C2A470GA16#
				±0.5pF	GCM1885C2A9R8DA16#					±5%	GCM1885C2A470JA16#
			9.9pF	±0.1pF	GCM1885C2A9R9BA16#				51pF	±1%	GCM1885C2A510FA16#
				±0.25pF	GCM1885C2A9R9CA16#					±2%	GCM1885C2A510GA16#
				±0.5pF	GCM1885C2A9R9DA16#					±5%	GCM1885C2A510JA16#
			10pF	±1%	GCM1885C2A100FA16#				56pF	±1%	GCM1885C2A560FA16#
				±2%	GCM1885C2A100GA16#					±2%	GCM1885C2A560GA16#
				±2.5%	GCM1885C2A100RA16#					±5%	GCM1885C2A560JA16#
				±5%	GCM1885C2A100JA16#					62pF	±1%
			11pF	±1%	GCM1885C2A110FA16#				±2%		GCM1885C2A620GA16#
				±2%	GCM1885C2A110GA16#				±5%		GCM1885C2A620JA16#
				±5%	GCM1885C2A110JA16#				68pF		±1%
			12pF	±1%	GCM1885C2A120FA16#					±2%	GCM1885C2A680GA16#
				±2%	GCM1885C2A120GA16#					±5%	GCM1885C2A680JA16#
				±5%	GCM1885C2A120JA16#				75pF	±1%	GCM1885C2A750FA16#
			13pF	±1%	GCM1885C2A130FA16#					±2%	GCM1885C2A750GA16#
				±2%	GCM1885C2A130GA16#					±5%	GCM1885C2A750JA16#
				±5%	GCM1885C2A130JA16#				82pF	±1%	GCM1885C2A820FA16#
			15pF	±1%	GCM1885C2A150FA16#					±2%	GCM1885C2A820GA16#
				±2%	GCM1885C2A150GA16#					±5%	GCM1885C2A820JA16#
				±5%	GCM1885C2A150JA16#				91pF	±1%	GCM1885C2A910FA16#
			16pF	±1%	GCM1885C2A160FA16#					±2%	GCM1885C2A910GA16#
				±2%	GCM1885C2A160GA16#					±5%	GCM1885C2A910JA16#
				±5%	GCM1885C2A160JA16#				100pF	±1%	GCM1885C2A101FA16#
			18pF	±1%	GCM1885C2A180FA16#					±2%	GCM1885C2A101GA16#
				±2%	GCM1885C2A180GA16#					±5%	GCM1885C2A101JA16#
				±5%	GCM1885C2A180JA16#				110pF	±1%	GCM1885C2A111FA16#
			20pF	±1%	GCM1885C2A200FA16#					±2%	GCM1885C2A111GA16#
±2%	GCM1885C2A200GA16#	±5%		GCM1885C2A111JA16#							
±5%	GCM1885C2A200JA16#	120pF		±1%	GCM1885C2A121FA16#						
22pF	±1%		GCM1885C2A220FA16#	±2%	GCM1885C2A121GA16#						
	±2%		GCM1885C2A220GA16#	±5%	GCM1885C2A121JA16#						
	±5%	GCM1885C2A220JA16#	130pF	±1%	GCM1885C2A131FA16#						
24pF	±1%	GCM1885C2A240FA16#									

GRT Series
 GCM Series
 GC3 Series
 GCJ Series
 GCQ Series
 GCD Series
 GCE Series
 NMF Series
 KCM Series
 KC3 Series
 KCA Series
 GCB Series
 GCG Series
 △Caution /Notice

Part number # indicates the package specification code.

GCM Series Temperature Compensating Type Part Number List

(→ 1.6×0.8mm)

T max.	Rated Voltage	TC Code	Cap.	Tol.	Part Number	T max.	Rated Voltage	TC Code	Cap.	Tol.	Part Number	
0.9mm	100Vdc	COG	130pF	±2%	GCM1885C2A131GA16#	0.9mm	100Vdc	COG	750pF	±2%	GCM1885C2A751GA16#	
				±5%	GCM1885C2A131JA16#					±5%	GCM1885C2A751JA16#	
				±1%	GCM1885C2A151FA16#					±1%	GCM1885C2A821FA16#	
			±2%		GCM1885C2A151GA16#				±2%		GCM1885C2A821GA16#	
			±5%		GCM1885C2A151JA16#				±5%		GCM1885C2A821JA16#	
			150pF	±1%	GCM1885C2A161FA16#				910pF	±1%	GCM1885C2A911FA16#	
				±2%	GCM1885C2A161GA16#					±2%	GCM1885C2A911GA16#	
				±5%	GCM1885C2A161JA16#					±5%	GCM1885C2A911JA16#	
			180pF	±1%	GCM1885C2A181FA16#				1000pF	±1%	GCM1885C2A102FA16#	
				±2%	GCM1885C2A181GA16#					±2%	GCM1885C2A102GA16#	
				±5%	GCM1885C2A181JA16#					±5%	GCM1885C2A102JA16#	
			200pF	±1%	GCM1885C2A201FA16#				1200pF	±1%	GCM1885C2A122FA16#	
				±2%	GCM1885C2A201GA16#					±2%	GCM1885C2A122GA16#	
				±5%	GCM1885C2A201JA16#					±5%	GCM1885C2A122JA16#	
			220pF	±1%	GCM1885C2A221FA16#				1300pF	±2%	GCM1885C2A132GA16#	
				±2%	GCM1885C2A221GA16#					±5%	GCM1885C2A132JA16#	
				±5%	GCM1885C2A221JA16#					1500pF	±2%	GCM1885C2A152GA16#
			±1%	GCM1885C2A241FA16#	±2%				GCM1885C2A152JA16#			
				±2%					GCM1885C2A241GA16#		±5%	GCM1887U2A102JA16#
				±5%					GCM1885C2A241JA16#	±5%		GCM1887U2A112JA16#
			270pF	±1%	GCM1885C2A271FA16#				1200pF	±5%		GCM1887U2A122JA16#
				±2%	GCM1885C2A271GA16#					1300pF	±5%	GCM1887U2A132JA16#
				±5%	GCM1885C2A271JA16#						1500pF	±5%
			300pF	±1%	GCM1885C2A301FA16#				1600pF			±5%
				±2%	GCM1885C2A301GA16#					1800pF		±5%
				±5%	GCM1885C2A301JA16#						2000pF	±5%
			330pF	±1%	GCM1885C2A331FA16#				2200pF			±5%
				±2%	GCM1885C2A331GA16#					2400pF		±5%
				±5%	GCM1885C2A331JA16#						2700pF	±5%
			360pF	±1%	GCM1885C2A361FA16#				3000pF			±5%
				±2%	GCM1885C2A361GA16#					3300pF		±5%
				±5%	GCM1885C2A361JA16#						3600pF	±5%
			390pF	±1%	GCM1885C2A391FA16#				3900pF			±5%
				±2%	GCM1885C2A391GA16#					4300pF		±5%
				±5%	GCM1885C2A391JA16#						4700pF	±5%
			430pF	±1%	GCM1885C2A431FA16#				5100pF			±5%
				±2%	GCM1885C2A431GA16#					5600pF		±5%
				±5%	GCM1885C2A431JA16#						6200pF	±5%
			470pF	±1%	GCM1885C2A471FA16#				6800pF			±5%
				±2%	GCM1885C2A471GA16#					7500pF		±5%
				±5%	GCM1885C2A471JA16#						8200pF	±5%
			510pF	±1%	GCM1885C2A511FA16#				9100pF			±5%
				±2%	GCM1885C2A511GA16#					10000pF		±5%
				±5%	GCM1885C2A511JA16#						X8G	10pF
			±1%	GCM1885C2A561FA16#	±2.5%				GCM1885G2A100RA16#			
				±2%					GCM1885C2A561GA16#	±5%		
				±5%					GCM1885C2A561JA16#	11pF	±1%	GCM1885G2A110FA16#
			±1%	GCM1885C2A621FA16#	±2%				GCM1885G2A110GA16#			
				±2%					GCM1885C2A621GA16#		±5%	GCM1885G2A110JA16#
				±5%					GCM1885C2A621JA16#	12pF	±1%	GCM1885G2A120FA16#
			±1%	GCM1885C2A681FA16#	±2%				GCM1885G2A120GA16#			
				±2%					GCM1885C2A681GA16#		±5%	GCM1885G2A120JA16#
				±5%					GCM1885C2A681JA16#	13pF	±1%	GCM1885G2A130FA16#
			±1%	GCM1885C2A751FA16#	±2%				GCM1885G2A130GA16#			

GRT Series
 GCM Series
 GC3 Series
 GCJ Series
 GCQ Series
 GCD Series
 GCE Series
 NMF Series
 KCM Series
 KC3 Series
 KCA Series
 GCB Series
 GCG Series
 ⚠Caution /Notice

Part number # indicates the package specification code.

GCM Series Temperature Compensating Type Part Number List

(→ 1.6×0.8mm)

T max.	Rated Voltage	TC Code	Cap.	Tol.	Part Number	T max.	Rated Voltage	TC Code	Cap.	Tol.	Part Number		
0.9mm	100Vdc	X8G	13pF	±5%	GCM1885G2A130JA16#	0.9mm	100Vdc	X8G	75pF	±5%	GCM1885G2A750JA16#		
				15pF	±1%					GCM1885G2A150FA16#	82pF	±1%	GCM1885G2A820FA16#
					±2%					GCM1885G2A150GA16#		±2%	GCM1885G2A820GA16#
			±5%		GCM1885G2A150JA16#				±5%	GCM1885G2A820JA16#			
			16pF	±1%	GCM1885G2A160FA16#				91pF	±1%	GCM1885G2A910FA16#		
				±2%	GCM1885G2A160GA16#					±2%	GCM1885G2A910GA16#		
				±5%	GCM1885G2A160JA16#					±5%	GCM1885G2A910JA16#		
			18pF	±1%	GCM1885G2A180FA16#				100pF	±1%	GCM1885G2A101FA16#		
				±2%	GCM1885G2A180GA16#					±2%	GCM1885G2A101GA16#		
				±5%	GCM1885G2A180JA16#					±5%	GCM1885G2A101JA16#		
			20pF	±1%	GCM1885G2A200FA16#				110pF	±1%	GCM1885G2A111FA16#		
				±2%	GCM1885G2A200GA16#					±2%	GCM1885G2A111GA16#		
				±5%	GCM1885G2A200JA16#					±5%	GCM1885G2A111JA16#		
			22pF	±1%	GCM1885G2A220FA16#				120pF	±1%	GCM1885G2A121FA16#		
				±2%	GCM1885G2A220GA16#					±2%	GCM1885G2A121GA16#		
				±5%	GCM1885G2A220JA16#					±5%	GCM1885G2A121JA16#		
			24pF	±1%	GCM1885G2A240FA16#				130pF	±1%	GCM1885G2A131FA16#		
				±2%	GCM1885G2A240GA16#					±2%	GCM1885G2A131GA16#		
				±5%	GCM1885G2A240JA16#					±5%	GCM1885G2A131JA16#		
			27pF	±1%	GCM1885G2A270FA16#				150pF	±1%	GCM1885G2A151FA16#		
				±2%	GCM1885G2A270GA16#					±2%	GCM1885G2A151GA16#		
				±5%	GCM1885G2A270JA16#					±5%	GCM1885G2A151JA16#		
			30pF	±1%	GCM1885G2A300FA16#				160pF	±1%	GCM1885G2A161FA16#		
				±2%	GCM1885G2A300GA16#					±2%	GCM1885G2A161GA16#		
				±5%	GCM1885G2A300JA16#					±5%	GCM1885G2A161JA16#		
			33pF	±1%	GCM1885G2A330FA16#				180pF	±1%	GCM1885G2A181FA16#		
				±2%	GCM1885G2A330GA16#					±2%	GCM1885G2A181GA16#		
				±5%	GCM1885G2A330JA16#					±5%	GCM1885G2A181JA16#		
			36pF	±1%	GCM1885G2A360FA16#				200pF	±1%	GCM1885G2A201FA16#		
				±2%	GCM1885G2A360GA16#					±2%	GCM1885G2A201GA16#		
				±5%	GCM1885G2A360JA16#					±5%	GCM1885G2A201JA16#		
			39pF	±1%	GCM1885G2A390FA16#				220pF	±1%	GCM1885G2A221FA16#		
				±2%	GCM1885G2A390GA16#					±2%	GCM1885G2A221GA16#		
				±5%	GCM1885G2A390JA16#					±5%	GCM1885G2A221JA16#		
			43pF	±1%	GCM1885G2A430FA16#				240pF	±1%	GCM1885G2A241FA16#		
				±2%	GCM1885G2A430GA16#					±2%	GCM1885G2A241GA16#		
				±5%	GCM1885G2A430JA16#					±5%	GCM1885G2A241JA16#		
			47pF	±1%	GCM1885G2A470FA16#				270pF	±1%	GCM1885G2A271FA16#		
				±2%	GCM1885G2A470GA16#					±2%	GCM1885G2A271GA16#		
				±5%	GCM1885G2A470JA16#					±5%	GCM1885G2A271JA16#		
			51pF	±1%	GCM1885G2A510FA16#				300pF	±1%	GCM1885G2A301FA16#		
				±2%	GCM1885G2A510GA16#					±2%	GCM1885G2A301GA16#		
±5%	GCM1885G2A510JA16#	±5%		GCM1885G2A301JA16#									
56pF	±1%	GCM1885G2A560FA16#	330pF	±1%	GCM1885G2A331FA16#								
	±2%	GCM1885G2A560GA16#		±2%	GCM1885G2A331GA16#								
	±5%	GCM1885G2A560JA16#		±5%	GCM1885G2A331JA16#								
62pF	±1%	GCM1885G2A620FA16#	360pF	±1%	GCM1885G2A361FA16#								
	±2%	GCM1885G2A620GA16#		±2%	GCM1885G2A361GA16#								
	±5%	GCM1885G2A620JA16#		±5%	GCM1885G2A361JA16#								
68pF	±1%	GCM1885G2A680FA16#	390pF	±1%	GCM1885G2A391FA16#								
	±2%	GCM1885G2A680GA16#		±2%	GCM1885G2A391GA16#								
	±5%	GCM1885G2A680JA16#		±5%	GCM1885G2A391JA16#								
75pF	±1%	GCM1885G2A750FA16#	430pF	±1%	GCM1885G2A431FA16#								
	±2%	GCM1885G2A750GA16#		±2%	GCM1885G2A431GA16#								

GRT Series
 GCM Series
 GC3 Series
 GCJ Series
 GCQ Series
 GCD Series
 GCE Series
 NMF Series
 KCM Series
 KC3 Series
 KCA Series
 GCB Series
 GCG Series
 ⚠Caution /Notice

Part number # indicates the package specification code.

GCM Series Temperature Compensating Type Part Number List

(→ 1.6×0.8mm)

T max.	Rated Voltage	TC Code	Cap.	Tol.	Part Number	T max.	Rated Voltage	TC Code	Cap.	Tol.	Part Number							
0.9mm	100Vdc	X8G	430pF	±5%	GCM1885G2A431JA16#	0.9mm	63Vdc	COG	2200pF	±2%	GCM1885C1J222GA16#							
				±1%	GCM1885G2A471FA16#					±5%	GCM1885C1J222JA16#							
				±2%	GCM1885G2A471GA16#					2400pF	±2%	GCM1885C1J242GA16#						
				±5%	GCM1885G2A471JA16#						±5%	GCM1885C1J242JA16#						
			510pF	±1%	GCM1885G2A511FA16#				2700pF	±2%	GCM1885C1J272GA16#							
				±2%	GCM1885G2A511GA16#					±5%	GCM1885C1J272JA16#							
				±5%	GCM1885G2A511JA16#					3000pF	±2%	GCM1885C1J302GA16#						
			560pF	±1%	GCM1885G2A561FA16#				±5%		GCM1885C1J302JA16#							
				±2%	GCM1885G2A561GA16#				3300pF	±2%	GCM1885C1J332GA16#							
				±5%	GCM1885G2A561JA16#					±5%	GCM1885C1J332JA16#							
			620pF	±1%	GCM1885G2A621FA16#				3600pF	±2%	GCM1885C1J362GA16#							
				±2%	GCM1885G2A621GA16#					±5%	GCM1885C1J362JA16#							
				±5%	GCM1885G2A621JA16#					3900pF	±2%	GCM1885C1J392GA16#						
			680pF	±1%	GCM1885G2A681FA16#				±5%		GCM1885C1J392JA16#							
				±2%	GCM1885G2A681GA16#				50Vdc	COG	1100pF	±1%	GCM1885C1H112FA16#					
				±5%	GCM1885G2A681JA16#							±2%	GCM1885C1H112GA16#					
			750pF	±1%	GCM1885G2A751FA16#							±5%	GCM1885C1H112JA16#					
				±2%	GCM1885G2A751GA16#				1200pF	±1%	GCM1885C1H122FA16#							
				±5%	GCM1885G2A751JA16#					±2%	GCM1885C1H122GA16#							
			820pF	±1%	GCM1885G2A821FA16#				±5%	GCM1885C1H122JA16#	1300pF	±1%	GCM1885C1H132FA16#					
				±2%	GCM1885G2A821GA16#				±2%	GCM1885C1H132GA16#								
				±5%	GCM1885G2A821JA16#				±5%	GCM1885C1H132JA16#								
			910pF	±1%	GCM1885G2A911FA16#				1500pF	±1%	GCM1885C1H152FA16#							
				±2%	GCM1885G2A911GA16#					±2%	GCM1885C1H152GA16#							
				±5%	GCM1885G2A911JA16#					±5%	GCM1885C1H152JA16#							
			1000pF	±1%	GCM1885G2A102FA16#				1600pF	±1%	GCM1885C1H162FA16#							
				±2%	GCM1885G2A102GA16#					±2%	GCM1885C1H162GA16#							
				±5%	GCM1885G2A102JA16#					±5%	GCM1885C1H162JA16#							
			80Vdc	COG	1600pF				±2%	GCM1885C1K162GA16#	1800pF	±1%	GCM1885C1H182FA16#					
									±5%	GCM1885C1K162JA16#		±2%	GCM1885C1H182GA16#					
					1800pF				±2%	GCM1885C1K182GA16#		±5%	GCM1885C1H182JA16#	2000pF	±1%	GCM1885C1H202FA16#		
									±5%	GCM1885C1K182JA16#		±2%	GCM1885C1H202GA16#					
					2000pF				±2%	GCM1885C1K202GA16#		±5%	GCM1885C1H202JA16#	2200pF	±1%	GCM1885C1H222FA16#		
									±5%	GCM1885C1K202JA16#		±2%	GCM1885C1H222GA16#					
					2200pF				±2%	GCM1885C1K222GA16#		±5%	GCM1885C1H222JA16#	2400pF	±1%	GCM1885C1H242FA16#		
									±5%	GCM1885C1K222JA16#		±2%	GCM1885C1H242GA16#					
					2400pF				±2%	GCM1885C1K242GA16#		±5%	GCM1885C1K242JA16#	2700pF	±1%	GCM1885C1H272FA16#		
									±5%	GCM1885C1K242JA16#		±2%	GCM1885C1H272GA16#					
					2700pF				±2%	GCM1885C1K272GA16#		±5%	GCM1885C1K272JA16#	3000pF	±1%	GCM1885C1H302FA16#		
									±5%	GCM1885C1K272JA16#		±2%	GCM1885C1H302GA16#					
					3000pF				±2%	GCM1885C1K302GA16#		±5%	GCM1885C1K302JA16#	3300pF	±1%	GCM1885C1H332FA16#		
									±5%	GCM1885C1K302JA16#		±2%	GCM1885C1H332GA16#					
					3300pF				±2%	GCM1885C1K332GA16#		±5%	GCM1885C1K332JA16#	3600pF	±1%	GCM1885C1H362FA16#		
									±5%	GCM1885C1K332JA16#		±2%	GCM1885C1H362GA16#					
					3600pF				±2%	GCM1885C1K362GA16#		±5%	GCM1885C1K362JA16#	3900pF	±1%	GCM1885C1H392FA16#		
									±5%	GCM1885C1K362JA16#		±2%	GCM1885C1H392GA16#					
					3900pF				±2%	GCM1885C1K392GA16#		±5%	GCM1885C1K392JA16#	63Vdc	COG	1600pF	±2%	GCM1885C1J162GA16#
									±5%	GCM1885C1K392JA16#		±5%	GCM1885C1J162JA16#					
					1800pF				±2%	GCM1885C1J182GA16#		±5%	GCM1885C1J182JA16#			1800pF	±2%	GCM1885C1J182GA16#
									±5%	GCM1885C1J182JA16#		±5%	GCM1885C1J182JA16#					
					2000pF				±2%	GCM1885C1J202GA16#		±5%	GCM1885C1J202JA16#			2000pF	±2%	GCM1885C1J202GA16#
									±5%	GCM1885C1J202JA16#		±5%	GCM1885C1J202JA16#					

Part number # indicates the package specification code.

GRT Series
 GCM Series
 GC3 Series
 GCJ Series
 GCQ Series
 GCD Series
 GCE Series
 NMF Series
 KCM Series
 KC3 Series
 KCA Series
 GCB Series
 GCG Series
 ⚠Caution /Notice

GCM Series Temperature Compensating Type Power-train AEC-Q200 Part Number List

(→ 1.6×0.8mm)

T max.	Rated Voltage	TC Code	Cap.	Tol.	Part Number			
0.9mm	50Vdc	COG	3900pF	±2%	GCM1885C1H392GA16#			
				±5%	GCM1885C1H392JA16#			
			4300pF	±2%	GCM1885C1H432GA16#			
				±5%	GCM1885C1H432JA16#			
			4700pF	±1%	GCM1885C1H472FA16#			
				±2%	GCM1885C1H472GA16#			
				±5%	GCM1885C1H472JA16#			
			5100pF	±2%	GCM1885C1H512GA16#			
				±5%	GCM1885C1H512JA16#			
				5600pF	±2%	GCM1885C1H562GA16#		
			±5%		GCM1885C1H562JA16#			
			6200pF	±2%	GCM1885C1H622GA16#			
				±5%	GCM1885C1H622JA16#			
			6800pF	±2%	GCM1885C1H682GA16#			
				±5%	GCM1885C1H682JA16#			
				7500pF	±2%	GCM1885C1H752GA16#		
			±5%		GCM1885C1H752JA16#			
			8200pF	±2%	GCM1885C1H822GA16#			
				±5%	GCM1885C1H822JA16#			
			9100pF	±2%	GCM1885C1H912GA16#			
				±5%	GCM1885C1H912JA16#			
			10000pF	±2%	GCM1885C1H103GA16#			
				±5%	GCM1885C1H103JA16#			
			U2J	50Vdc	COG	1000pF	±5%	GCM1887U1H102JA16#
							±5%	GCM1887U1H112JA16#
							±5%	GCM1887U1H122JA16#
							±5%	GCM1887U1H132JA16#
							±5%	GCM1887U1H152JA16#
							±5%	GCM1887U1H162JA16#
							±5%	GCM1887U1H182JA16#
							±5%	GCM1887U1H202JA16#
							±5%	GCM1887U1H222JA16#
							±5%	GCM1887U1H242JA16#
							±5%	GCM1887U1H272JA16#
							±5%	GCM1887U1H302JA16#
							±5%	GCM1887U1H332JA16#
		±5%					GCM1887U1H362JA16#	
		±5%					GCM1887U1H392JA16#	
		±5%					GCM1887U1H432JA16#	
		±5%					GCM1887U1H472JA16#	
		±5%					GCM1887U1H512JA16#	
		±5%					GCM1887U1H562JA16#	
		±5%					GCM1887U1H622JA16#	
		X8G					50Vdc	COG
			±2%	GCM1885G1H112GA16#				
			±5%	GCM1885G1H112JA16#				
			1200pF	±1%	GCM1885G1H122FA16#			
				±2%	GCM1885G1H122GA16#			
				±5%	GCM1885G1H122JA16#			

T max.	Rated Voltage	TC Code	Cap.	Tol.	Part Number
0.9mm	50Vdc	X8G	1300pF	±1%	GCM1885G1H132FA16#
				±2%	GCM1885G1H132GA16#
				±5%	GCM1885G1H132JA16#
			1500pF	±1%	GCM1885G1H152FA16#
				±2%	GCM1885G1H152GA16#
				±5%	GCM1885G1H152JA16#
			1600pF	±1%	GCM1885G1H162FA16#
				±2%	GCM1885G1H162GA16#
				±5%	GCM1885G1H162JA16#
			1800pF	±1%	GCM1885G1H182FA16#
				±2%	GCM1885G1H182GA16#
				±5%	GCM1885G1H182JA16#
			2000pF	±1%	GCM1885G1H202FA16#
				±2%	GCM1885G1H202GA16#
				±5%	GCM1885G1H202JA16#
			2200pF	±1%	GCM1885G1H222FA16#
				±2%	GCM1885G1H222GA16#
				±5%	GCM1885G1H222JA16#
			2400pF	±1%	GCM1885G1H242FA16#
				±2%	GCM1885G1H242GA16#
				±5%	GCM1885G1H242JA16#
			2700pF	±1%	GCM1885G1H272FA16#
				±2%	GCM1885G1H272GA16#
				±5%	GCM1885G1H272JA16#

2.0×1.25mm

T max.	Rated Voltage	TC Code	Cap.	Tol.	Part Number		
0.7mm	100Vdc	COG	1600pF	±1%	GCM2165C2A162FA16#		
				±2%	GCM2165C2A162GA16#		
				±5%	GCM2165C2A162JA16#		
			1800pF	±1%	GCM2165C2A182FA16#		
				±2%	GCM2165C2A182GA16#		
				±5%	GCM2165C2A182JA16#		
			2000pF	±1%	GCM2165C2A202FA16#		
				±2%	GCM2165C2A202GA16#		
				±5%	GCM2165C2A202JA16#		
			2200pF	±1%	GCM2165C2A222FA16#		
				±2%	GCM2165C2A222GA16#		
				±5%	GCM2165C2A222JA16#		
			2400pF	±1%	GCM2165C2A242FA16#		
				±2%	GCM2165C2A242GA16#		
				±5%	GCM2165C2A242JA16#		
			2700pF	±1%	GCM2165C2A272FA16#		
				±2%	GCM2165C2A272GA16#		
				±5%	GCM2165C2A272JA16#		
			3000pF	±1%	GCM2165C2A302FA16#		
				±2%	GCM2165C2A302GA16#		
				±5%	GCM2165C2A302JA16#		
			3300pF	±1%	GCM2165C2A332FA16#		
				±2%	GCM2165C2A332GA16#		
				±5%	GCM2165C2A332JA16#		
			80Vdc	COG	4300pF	±1%	GCM2165C1K432FA16#

Part number # indicates the package specification code.

GRT Series
 GCM Series
 GC3 Series
 GCJ Series
 GCQ Series
 GCD Series
 GCE Series
 NMF Series
 KCM Series
 KC3 Series
 KCA Series
 GCB Series
 GCG Series
 ⚠Caution /Notice

GCM Series Temperature Compensating Type Part Number List

(→ 2.0×1.25mm)

T max.	Rated Voltage	TC Code	Cap.	Tol.	Part Number	
0.7mm	80Vdc	COG	4300pF	±2%	GCM2165C1K432GA16#	
				±5%	GCM2165C1K432JA16#	
				±1%	GCM2165C1K472FA16#	
			4700pF	±2%	GCM2165C1K472GA16#	
				±5%	GCM2165C1K472JA16#	
				50Vdc	X8G	3000pF
	±5%	GCM2165G1H302JA16#				
	3300pF	±2%	GCM2165G1H332GA16#			
		±5%	GCM2165G1H332JA16#			
	3600pF	±2%	GCM2165G1H362GA16#			
		±5%	GCM2165G1H362JA16#			
	3900pF	±2%	GCM2165G1H392GA16#			
		±5%	GCM2165G1H392JA16#			
	4300pF	±2%	GCM2165G1H432GA16#			
		±5%	GCM2165G1H432JA16#			
		4700pF	±2%	GCM2165G1H472GA16#		
			±5%	GCM2165G1H472JA16#		
			0.95mm	100Vdc	X8G	1100pF
±5%		GCM2195G2A112JA16#				
1200pF	±2%	GCM2195G2A122GA16#				
	±5%	GCM2195G2A122JA16#				
1300pF	±2%	GCM2195G2A132GA16#				
	±5%	GCM2195G2A132JA16#				
1500pF	±2%	GCM2195G2A152GA16#				
	±5%	GCM2195G2A152JA16#				
ZLM	1000pF	±10%			GCM2199E2A102KA05#	
		±20%			GCM2199E2A102MA05#	
	1100pF	±10%			GCM2199E2A112KA05#	
		±20%			GCM2199E2A112MA05#	
	1200pF	±10%	GCM2199E2A122KA05#			
		±20%	GCM2199E2A122MA05#			
1300pF	±10%	GCM2199E2A132KA05#				
	±20%	GCM2199E2A132MA05#				
1500pF	±10%	GCM2199E2A152KA05#				
	±20%	GCM2199E2A152MA05#				
80Vdc	COG	5100pF	±1%	GCM2195C1K512FA16#		
			±1%	GCM2195C1K562FA16#		
			±2%	GCM2195C1K622GA16#		
		6200pF	±5%	GCM2195C1K622JA16#		
			±2%	GCM2195C1K682GA16#		
			±5%	GCM2195C1K682JA16#		
		7500pF	±2%	GCM2195C1K752GA16#		
			±5%	GCM2195C1K752JA16#		
		8200pF	±2%	GCM2195C1K822GA16#		
			±5%	GCM2195C1K822JA16#		
		9100pF	±2%	GCM2195C1K912GA16#		
			±5%	GCM2195C1K912JA16#		
		10000pF	±1%	GCM2195C1K103FA16#		
			±2%	GCM2195C1K103GA16#		
			±5%	GCM2195C1K103JA16#		
		11000pF	±2%	GCM2195C1K113GA16#		
			±5%	GCM2195C1K113JA16#		
		12000pF	±2%	GCM2195C1K123GA16#		
±5%	GCM2195C1K123JA16#					

T max.	Rated Voltage	TC Code	Cap.	Tol.	Part Number
0.95mm	80Vdc	COG	13000pF	±2%	GCM2195C1K133GA16#
				±5%	GCM2195C1K133JA16#
				±1%	GCM2195C1K153FA16#
			15000pF	±2%	GCM2195C1K153GA16#
				±5%	GCM2195C1K153JA16#
				50Vdc	COG
	±2%	GCM2195C1H123GA16#			
	±5%	GCM2195C1H123JA16#			
	13000pF	±1%	GCM2195C1H133FA16#		
		±2%	GCM2195C1H133GA16#		
		±5%	GCM2195C1H133JA16#		
	15000pF	±1%	GCM2195C1H153FA16#		
		±2%	GCM2195C1H153GA16#		
		±5%	GCM2195C1H153JA16#		
		X8G	3900pF	±2%	GCM2195G1H392GA16#
				±5%	GCM2195G1H392JA16#
			4300pF	±2%	GCM2195G1H432GA16#
	±5%			GCM2195G1H432JA16#	
4700pF	±2%		GCM2195G1H472GA16#		
	±5%		GCM2195G1H472JA16#		
5100pF	±2%		GCM2195G1H512GA16#		
	±5%		GCM2195G1H512JA16#		
5600pF	±2%		GCM2195G1H562GA16#		
	±5%		GCM2195G1H562JA16#		
6200pF	±2%		GCM2195G1H622GA16#		
	±5%		GCM2195G1H622JA16#		
6800pF	±2%	GCM2195G1H682GA16#			
	±5%	GCM2195G1H682JA16#			
7500pF	±2%	GCM2195G1H752GA16#			
	±5%	GCM2195G1H752JA16#			
8200pF	±2%	GCM2195G1H822GA16#			
	±5%	GCM2195G1H822JA16#			
9100pF	±2%	GCM2195G1H912GA16#			
	±5%	GCM2195G1H912JA16#			
10000pF	±2%	GCM2195G1H103GA16#			
	±5%	GCM2195G1H103JA16#			
1.0mm	630Vdc	COG	10pF	±1%	GCM21A5C2J100FX01#
				±2%	GCM21A5C2J100GX01#
				±5%	GCM21A5C2J100JX01#
			12pF	±1%	GCM21A5C2J120FX01#
				±2%	GCM21A5C2J120GX01#
				±5%	GCM21A5C2J120JX01#
			15pF	±1%	GCM21A5C2J150FX01#
				±2%	GCM21A5C2J150GX01#
				±5%	GCM21A5C2J150JX01#
			18pF	±1%	GCM21A5C2J180FX01#
				±2%	GCM21A5C2J180GX01#
				±5%	GCM21A5C2J180JX01#
			22pF	±1%	GCM21A5C2J220FX01#
				±2%	GCM21A5C2J220GX01#
				±5%	GCM21A5C2J220JX01#
			27pF	±1%	GCM21A5C2J270FX01#
				±2%	GCM21A5C2J270GX01#
				±5%	GCM21A5C2J270JX01#

Part number # indicates the package specification code.

GCM Series Temperature Compensating Type Part Number List

(→ 2.0×1.25mm)

T max.	Rated Voltage	TC Code	Cap.	Tol.	Part Number		
1.0mm	630Vdc	COG	33pF	±1%	GCM21A5C2J330FX01#		
				±2%	GCM21A5C2J330GX01#		
				±5%	GCM21A5C2J330JX01#		
			39pF	±1%	GCM21A5C2J390FX01#		
				±2%	GCM21A5C2J390GX01#		
				±5%	GCM21A5C2J390JX01#		
			47pF	±1%	GCM21A5C2J470FX01#		
				±2%	GCM21A5C2J470GX01#		
				±5%	GCM21A5C2J470JX01#		
			56pF	±1%	GCM21A5C2J560FX01#		
				±2%	GCM21A5C2J560GX01#		
				±5%	GCM21A5C2J560JX01#		
			68pF	±1%	GCM21A5C2J680FX01#		
				±2%	GCM21A5C2J680GX01#		
				±5%	GCM21A5C2J680JX01#		
			82pF	±1%	GCM21A5C2J820FX01#		
				±2%	GCM21A5C2J820GX01#		
				±5%	GCM21A5C2J820JX01#		
			100pF	±1%	GCM21A5C2J101FX01#		
				±2%	GCM21A5C2J101GX01#		
				±5%	GCM21A5C2J101JX01#		
			120pF	±1%	GCM21A5C2J121FX01#		
				±2%	GCM21A5C2J121GX01#		
				±5%	GCM21A5C2J121JX01#		
			150pF	±1%	GCM21A5C2J151FX01#		
				±2%	GCM21A5C2J151GX01#		
				±5%	GCM21A5C2J151JX01#		
			180pF	±1%	GCM21A5C2J181FX01#		
				±2%	GCM21A5C2J181GX01#		
				±5%	GCM21A5C2J181JX01#		
			220pF	±1%	GCM21A5C2J221FX01#		
				±2%	GCM21A5C2J221GX01#		
				±5%	GCM21A5C2J221JX01#		
			270pF	±1%	GCM21A5C2J271FX01#		
				±2%	GCM21A5C2J271GX01#		
				±5%	GCM21A5C2J271JX01#		
			330pF	±1%	GCM21A5C2J331FX01#		
				±2%	GCM21A5C2J331GX01#		
				±5%	GCM21A5C2J331JX01#		
			390pF	±1%	GCM21A5C2J391FX01#		
				±2%	GCM21A5C2J391GX01#		
				±5%	GCM21A5C2J391JX01#		
			470pF	±1%	GCM21A5C2J471FX01#		
				±2%	GCM21A5C2J471GX01#		
				±5%	GCM21A5C2J471JX01#		
			560pF	±1%	GCM21A5C2J561FX01#		
				±2%	GCM21A5C2J561GX01#		
				±5%	GCM21A5C2J561JX01#		
			250Vdc	COG	10pF	±1%	GCM21A5C2E100FX01#
						±2%	GCM21A5C2E100GX01#
						±5%	GCM21A5C2E100JX01#
					12pF	±1%	GCM21A5C2E120FX01#
						±2%	GCM21A5C2E120GX01#
						±5%	GCM21A5C2E120JX01#

T max.	Rated Voltage	TC Code	Cap.	Tol.	Part Number
1.0mm	250Vdc	COG	15pF	±1%	GCM21A5C2E150FX01#
				±2%	GCM21A5C2E150GX01#
				±5%	GCM21A5C2E150JX01#
			18pF	±1%	GCM21A5C2E180FX01#
				±2%	GCM21A5C2E180GX01#
				±5%	GCM21A5C2E180JX01#
			22pF	±1%	GCM21A5C2E220FX01#
				±2%	GCM21A5C2E220GX01#
				±5%	GCM21A5C2E220JX01#
			27pF	±1%	GCM21A5C2E270FX01#
				±2%	GCM21A5C2E270GX01#
				±5%	GCM21A5C2E270JX01#
			33pF	±1%	GCM21A5C2E330FX01#
				±2%	GCM21A5C2E330GX01#
				±5%	GCM21A5C2E330JX01#
			39pF	±1%	GCM21A5C2E390FX01#
				±2%	GCM21A5C2E390GX01#
				±5%	GCM21A5C2E390JX01#
			47pF	±1%	GCM21A5C2E470FX01#
				±2%	GCM21A5C2E470GX01#
				±5%	GCM21A5C2E470JX01#
			56pF	±1%	GCM21A5C2E560FX01#
				±2%	GCM21A5C2E560GX01#
				±5%	GCM21A5C2E560JX01#
			68pF	±1%	GCM21A5C2E680FX01#
				±2%	GCM21A5C2E680GX01#
				±5%	GCM21A5C2E680JX01#
			82pF	±1%	GCM21A5C2E820FX01#
				±2%	GCM21A5C2E820GX01#
				±5%	GCM21A5C2E820JX01#
			100pF	±1%	GCM21A5C2E101FX01#
				±2%	GCM21A5C2E101GX01#
				±5%	GCM21A5C2E101JX01#
			120pF	±1%	GCM21A5C2E121FX01#
				±2%	GCM21A5C2E121GX01#
				±5%	GCM21A5C2E121JX01#
			150pF	±1%	GCM21A5C2E151FX01#
				±2%	GCM21A5C2E151GX01#
				±5%	GCM21A5C2E151JX01#
			180pF	±1%	GCM21A5C2E181FX01#
				±2%	GCM21A5C2E181GX01#
				±5%	GCM21A5C2E181JX01#
			220pF	±1%	GCM21A5C2E221FX01#
				±2%	GCM21A5C2E221GX01#
				±5%	GCM21A5C2E221JX01#
			270pF	±1%	GCM21A5C2E271FX01#
				±2%	GCM21A5C2E271GX01#
				±5%	GCM21A5C2E271JX01#
			330pF	±1%	GCM21A5C2E331FX01#
				±2%	GCM21A5C2E331GX01#
				±5%	GCM21A5C2E331JX01#
			390pF	±1%	GCM21A5C2E391FX01#
				±2%	GCM21A5C2E391GX01#
				±5%	GCM21A5C2E391JX01#

GRT Series
 GCM Series
 GC3 Series
 GCJ Series
 GCQ Series
 GCD Series
 GCE Series
 NMF Series
 KCM Series
 KC3 Series
 KCA Series
 GCB Series
 GCG Series
 ⚠Caution /Notice

Part number # indicates the package specification code.

GCM Series Temperature Compensating Type Part Number List

(→ 2.0×1.25mm)

T max.	Rated Voltage	TC Code	Cap.	Tol.	Part Number	T max.	Rated Voltage	TC Code	Cap.	Tol.	Part Number						
1.0mm	250Vdc	COG	470pF	±1%	GCM21A5C2E471FX01#	1.4mm	50Vdc	COG	18000pF	±2%	GCM21B5C1H183GA16#						
				±2%	GCM21A5C2E471GX01#					±5%	GCM21B5C1H183JA16#						
				±5%	GCM21A5C2E471JX01#					20000pF	±1%	GCM21B5C1H203FA16#					
			560pF	±1%	GCM21A5C2E561FX01#						±2%	GCM21B5C1H203GA16#					
				±2%	GCM21A5C2E561GX01#						±5%	GCM21B5C1H203JA16#					
				±5%	GCM21A5C2E561JX01#					22000pF	±1%	GCM21B5C1H223FA16#					
			680pF	±1%	GCM21A5C2E681FX01#						±2%	GCM21B5C1H223GA16#					
				±2%	GCM21A5C2E681GX01#						±5%	GCM21B5C1H223JA16#					
				±5%	GCM21A5C2E681JX01#					X8G	6200pF	±1%	GCM21B5G1H622FA16#				
			820pF	±1%	GCM21A5C2E821FX01#				±2%			GCM21B5G1H622GA16#					
				±2%	GCM21A5C2E821GX01#				±5%			GCM21B5G1H622JA16#					
				±5%	GCM21A5C2E821JX01#				6800pF	±1%	GCM21B5G1H682FA16#						
			1000pF	±1%	GCM21A5C2E102FX01#					±2%	GCM21B5G1H682GA16#						
				±2%	GCM21A5C2E102GX01#					±5%	GCM21B5G1H682JA16#						
				±5%	GCM21A5C2E102JX01#				7500pF	±1%	GCM21B5G1H752FA16#						
			1200pF	±1%	GCM21A5C2E122FX01#					±2%	GCM21B5G1H752GA16#						
				±2%	GCM21A5C2E122GX01#					±5%	GCM21B5G1H752JA16#						
				±5%	GCM21A5C2E122JX01#				8200pF	±1%	GCM21B5G1H822FA16#						
			1500pF	±1%	GCM21A5C2E152FX01#					±2%	GCM21B5G1H822GA16#						
				±2%	GCM21A5C2E152GX01#					±5%	GCM21B5G1H822JA16#						
				±5%	GCM21A5C2E152JX01#				9100pF	±1%	GCM21B5G1H912FA16#						
			1800pF	±1%	GCM21A5C2E182FX01#					±2%	GCM21B5G1H912GA16#						
				±2%	GCM21A5C2E182GX01#					±5%	GCM21B5G1H912JA16#						
				±5%	GCM21A5C2E182JX01#				10000pF	±1%	GCM21B5G1H103FA16#						
			2200pF	±1%	GCM21A5C2E222FX01#					±2%	GCM21B5G1H103GA16#						
				±2%	GCM21A5C2E222GX01#					±5%	GCM21B5G1H103JA16#						
				±5%	GCM21A5C2E222JX01#				1.45mm	630Vdc	COG	680pF	±1%	GCM21B5C2J681FX03#			
			2700pF	±1%	GCM21A5C2E272FX01#								±2%	GCM21B5C2J681GX03#			
				±2%	GCM21A5C2E272GX01#								±5%	GCM21B5C2J681JX03#			
				±5%	GCM21A5C2E272JX01#				820pF	±1%	GCM21B5C2J821FX03#						
			U2J	±1%	GCM21A7U2E101JX01#					±2%	GCM21B5C2J821GX03#						
				±5%	GCM21A7U2E121JX01#					±5%	GCM21B5C2J821JX03#						
				±5%	GCM21A7U2E151JX01#				1000pF	±1%	GCM21B5C2J102FX03#						
			±5%	GCM21A7U2E181JX01#	±2%					GCM21B5C2J102GX03#							
			±5%	GCM21A7U2E221JX01#	±5%					GCM21B5C2J102JX03#							
			±5%	GCM21A7U2E271JX01#	1200pF				±1%	GCM21B5C2J122FX03#							
			±5%	GCM21A7U2E331JX01#					±2%	GCM21B5C2J122GX03#							
			±5%	GCM21A7U2E391JX01#					±5%	GCM21B5C2J122JX03#							
			±5%	GCM21A7U2E471JX01#	1500pF				±1%	GCM21B5C2J152FX0A#							
			±5%	GCM21A7U2E561JX01#					±2%	GCM21B5C2J152GX0A#							
			±5%	GCM21A7U2E681JX01#					±5%	GCM21B5C2J152JX0A#							
			±5%	GCM21A7U2E821JX01#	1800pF				±1%	GCM21B5C2J182FX0A#							
			±5%	GCM21A7U2E102JX01#					±2%	GCM21B5C2J182GX0A#							
			±5%	GCM21A7U2E122JX01#					±5%	GCM21B5C2J182JX0A#							
			±5%	GCM21A7U2E152JX01#	2200pF				±1%	GCM21B5C2J222FX0A#							
			±5%	GCM21A7U2E182JX01#					±2%	GCM21B5C2J222GX0A#							
			±5%	GCM21A7U2E222JX01#					±5%	GCM21B5C2J222JX0A#							
			1.4mm	80Vdc	COG				18000pF	±2%	GCM21B5C1K183GA16#	250Vdc	COG	3300pF	±1%	GCM21B5C2E332FX01#	
										±5%	GCM21B5C1K183JA16#				±2%	GCM21B5C2E332GX01#	
									20000pF	±2%	GCM21B5C1K203GA16#				±5%	GCM21B5C2E332JX01#	
										±5%	GCM21B5C1K203JA16#				3900pF	±1%	GCM21B5C2E392FX01#
									22000pF	±2%	GCM21B5C1K223GA16#					±2%	GCM21B5C2E392GX01#
										±5%	GCM21B5C1K223JA16#					±5%	GCM21B5C2E392JX01#
									18000pF	±1%	GCM21B5C1H183FA16#				4700pF	±1%	GCM21B5C2E472FX01#
±1%	GCM21B5C1H183FA16#																

Part number # indicates the package specification code.

GRT Series
 GCM Series
 GC3 Series
 GCJ Series
 GCQ Series
 GCD Series
 GCE Series
 NMF Series
 KCM Series
 KC3 Series
 KCA Series
 GCB Series
 GCG Series
 ⚠Caution /Notice

GCM Series Temperature Compensating Type Part Number List

(→ 2.0×1.25mm)

T max.	Rated Voltage	TC Code	Cap.	Tol.	Part Number
1.45mm	250Vdc	COG	4700pF	±2%	GCM21B5C2E472GX01#
				±5%	GCM21B5C2E472JX01#
				±1%	GCM21B5C2E562FX0A#
			5600pF	±2%	GCM21B5C2E562GX0A#
				±5%	GCM21B5C2E562JX0A#
				±1%	GCM21B5C2E682FX0A#
			6800pF	±2%	GCM21B5C2E682GX0A#
				±5%	GCM21B5C2E682JX0A#
				±1%	GCM21B5C2E822FX0A#
			8200pF	±2%	GCM21B5C2E822GX0A#
				±5%	GCM21B5C2E822JX0A#
				±1%	GCM21B5C2E103FX0A#
			10000pF	±2%	GCM21B5C2E103GX0A#
				±5%	GCM21B5C2E103JX0A#
				U2J	2700pF
		3300pF	±5%		GCM21B7U2E332JX03#
		3900pF	±5%		GCM21B7U2E392JX03#
		4700pF	±5%		GCM21B7U2E472JX03#
		5600pF	±5%		GCM21B7U2E562JX03#

3.2×1.6mm

T max.	Rated Voltage	TC Code	Cap.	Tol.	Part Number
0.95mm	100Vdc	COG	3600pF	±1%	GCM3195C2A362FA16#
				±2%	GCM3195C2A362GA16#
				±5%	GCM3195C2A362JA16#
			3900pF	±1%	GCM3195C2A392FA16#
				±2%	GCM3195C2A392GA16#
				±5%	GCM3195C2A392JA16#
			4300pF	±1%	GCM3195C2A432FA16#
				±2%	GCM3195C2A432GA16#
				±5%	GCM3195C2A432JA16#
			4700pF	±1%	GCM3195C2A472FA16#
				±2%	GCM3195C2A472GA16#
				±5%	GCM3195C2A472JA16#
			5100pF	±1%	GCM3195C2A512FA16#
				±2%	GCM3195C2A512GA16#
				±5%	GCM3195C2A512JA16#
			5600pF	±1%	GCM3195C2A562FA16#
				±2%	GCM3195C2A562GA16#
				±5%	GCM3195C2A562JA16#
			6800pF	±2%	GCM3195C2A682GA16#
				±5%	GCM3195C2A682JA16#
				7500pF	±2%
			±5%		GCM3195C2A752JA16#
			8200pF		±1%
				±2%	GCM3195C2A822GA16#
				±5%	GCM3195C2A822JA16#
			9100pF	±1%	GCM3195C2A912FA16#
				±2%	GCM3195C2A912GA16#
				±5%	GCM3195C2A912JA16#
			10000pF	±1%	GCM3195C2A103FA16#
				±2%	GCM3195C2A103GA16#

T max.	Rated Voltage	TC Code	Cap.	Tol.	Part Number		
0.95mm	100Vdc	COG	10000pF	±5%	GCM3195C2A103JA16#		
				X8G	1600pF	±2%	GCM3195G2A162GA16#
						±5%	GCM3195G2A162JA16#
			±2%			GCM3195G2A182GA16#	
			1800pF	±5%	GCM3195G2A182JA16#		
				2000pF	±2%	GCM3195G2A202GA16#	
					±5%	GCM3195G2A202JA16#	
			2200pF		±2%	GCM3195G2A222GA16#	
				±5%	GCM3195G2A222JA16#		
				2400pF	±2%	GCM3195G2A242GA16#	
			±5%		GCM3195G2A242JA16#		
			2700pF		±2%	GCM3195G2A272GA16#	
				±5%	GCM3195G2A272JA16#		
				3000pF	±2%	GCM3195G2A302GA16#	
			±5%		GCM3195G2A302JA16#		
		3300pF	±2%		GCM3195G2A332GA16#		
			±5%	GCM3195G2A332JA16#			
			3600pF	±2%	GCM3195G2A362GA16#		
		±5%		GCM3195G2A362JA16#			
		3900pF		±2%	GCM3195G2A392GA16#		
			±5%	GCM3195G2A392JA16#			
			4300pF	±2%	GCM3195G2A432GA16#		
		±5%		GCM3195G2A432JA16#			
		4700pF		±2%	GCM3195G2A472GA16#		
			±5%	GCM3195G2A472JA16#			
			5100pF	±2%	GCM3195G2A512GA16#		
		±5%		GCM3195G2A512JA16#			
		5600pF		±2%	GCM3195G2A562GA16#		
			±5%	GCM3195G2A562JA16#			
			80Vdc	COG	27000pF	±2%	GCM3195C1K273GA16#
		±5%				GCM3195C1K273JA16#	
		33000pF			±2%	GCM3195C1K333GA16#	
					±5%	GCM3195C1K333JA16#	
					50Vdc	COG	27000pF
		±2%		GCM3195C1H273GA16#			
		±5%		GCM3195C1H273JA16#			
		33000pF		±1%			GCM3195C1H333FA16#
				±2%			GCM3195C1H333GA16#
		±5%		GCM3195C1H333JA16#			
		X8G	11000pF	±2%	GCM3195G1H113GA16#		
				±5%	GCM3195G1H113JA16#		
				12000pF	±2%	GCM3195G1H123GA16#	
					±5%	GCM3195G1H123JA16#	
					13000pF	±2%	GCM3195G1H133GA16#
			±5%	GCM3195G1H133JA16#			
			15000pF	±2%		GCM3195G1H153GA16#	
				±5%	GCM3195G1H153JA16#		
				16000pF	±2%	GCM3195G1H163GA16#	
			±5%		GCM3195G1H163JA16#		
			18000pF	±2%	GCM3195G1H183GA16#		
				±5%	GCM3195G1H183JA16#		

Part number # indicates the package specification code.

GCM Series Temperature Compensating Type Part Number List

(→ 3.2×1.6mm)

T max.	Rated Voltage	TC Code	Cap.	Tol.	Part Number	T max.	Rated Voltage	TC Code	Cap.	Tol.	Part Number						
0.95mm	50Vdc	X8G	2000pF	±2%	GCM3195G1H203GA16#	1.0mm	1000Vdc	COG	220pF	±5%	GCM3195G1H203JA16#						
				±2%	GCM3195G1H223GA16#					270pF	±1%	GCM31A5C3A271FX01#					
			±5%	GCM3195G1H223JA16#	±2%						GCM31A5C3A271GX01#						
			±1%	GCM31A5C3A100FX01#	±5%						GCM31A5C3A271JX01#						
±2%	GCM31A5C3A100GX01#	330pF	±1%	GCM31A5C3A331FX01#													
±5%	GCM31A5C3A100JX01#		±2%	GCM31A5C3A331GX01#													
±1%	GCM31A5C3A120FX01#		±5%	GCM31A5C3A331JX01#													
12pF	±1%	GCM31A5C3A120GX01#	±2%	GCM31A5C3A120JX01#	±1%				GCM31A5C3A391FX01#	±2%	GCM31A5C3A391GX01#	±1%	GCM31A5C3A391JX01#				
														±2%	GCM31A5C3A150FX01#	±2%	GCM31A5C3A471GX01#
±1%	GCM31A5C3A180FX01#	±1%	GCM31A7U3A100JX01#														
				±2%	GCM31A5C3A180GX01#				±2%	GCM31A7U3A120JX01#							
						±5%	GCM31A5C3A180JX01#	±5%			GCM31A7U3A150JX01#						
±1%	GCM31A5C3A220FX01#	±1%	GCM31A7U3A180JX01#														
				±2%	GCM31A5C3A220GX01#				±2%	GCM31A7U3A220JX01#							
						±5%	GCM31A5C3A220JX01#	±5%			GCM31A7U3A270JX01#						
±1%	GCM31A5C3A270FX01#	±1%	GCM31A7U3A330JX01#														
				±2%	GCM31A5C3A270GX01#				±2%	GCM31A7U3A390JX01#							
						±5%	GCM31A5C3A270JX01#	±5%			GCM31A7U3A470JX01#						
±1%	GCM31A5C3A330FX01#	±1%	GCM31A7U3A560JX01#														
				±2%	GCM31A5C3A330GX01#				±2%	GCM31A7U3A680JX01#							
						±5%	GCM31A5C3A330JX01#	±5%			GCM31A7U3A820JX01#						
±1%	GCM31A5C3A390FX01#	±1%	GCM31A7U3A101JX01#														
				±2%	GCM31A5C3A390GX01#				±2%	GCM31A7U3A121JX01#							
						±5%	GCM31A5C3A390JX01#	±5%			GCM31A7U3A151JX01#						
±1%	GCM31A5C3A470FX01#	±1%	GCM31A7U3A181JX01#														
				±2%	GCM31A5C3A470GX01#				±2%	GCM31A7U3A221JX01#							
						±5%	GCM31A5C3A470JX01#	±5%			GCM31A7U3A271JX01#						
±1%	GCM31A5C3A560FX01#	±1%	GCM31A7U3A331JX01#														
				±2%	GCM31A5C3A560GX01#				±2%	GCM31A5C2J100FX01#							
						±5%	GCM31A5C3A560JX01#	±5%			GCM31A5C2J100GX01#						
±1%	GCM31A5C3A680FX01#	±1%	GCM31A5C2J100JX01#														
				±2%	GCM31A5C3A680GX01#				±2%	GCM31A5C2J120FX01#							
						±5%	GCM31A5C3A680JX01#	±5%			GCM31A5C2J120GX01#						
±1%	GCM31A5C3A820FX01#	±1%	GCM31A5C2J120JX01#														
				±2%	GCM31A5C3A820GX01#				±2%	GCM31A5C2J150FX01#							
						±5%	GCM31A5C3A820JX01#	±5%			GCM31A5C2J150GX01#						
±1%	GCM31A5C3A101FX01#	±1%	GCM31A5C2J150JX01#														
				±2%	GCM31A5C3A101GX01#				±2%	GCM31A5C2J180FX01#							
						±5%	GCM31A5C3A101JX01#	±5%			GCM31A5C2J180GX01#						
±1%	GCM31A5C3A121FX01#	±1%	GCM31A5C2J180JX01#														
				±2%	GCM31A5C3A121GX01#				±2%	GCM31A5C2J220FX01#							
						±5%	GCM31A5C3A121JX01#	±5%			GCM31A5C2J220GX01#						
±1%	GCM31A5C3A151FX01#	±1%	GCM31A5C2J220JX01#														
				±2%	GCM31A5C3A151GX01#				±2%	GCM31A5C2J270FX01#							
						±5%	GCM31A5C3A151JX01#	±5%			GCM31A5C2J270GX01#						
±1%	GCM31A5C3A181FX01#	±1%	GCM31A5C2J270JX01#														
				±2%	GCM31A5C3A181GX01#				±2%	GCM31A5C2J330FX01#							
						±5%	GCM31A5C3A181JX01#	±5%			GCM31A5C2J330GX01#						
±1%	GCM31A5C3A221FX01#	±1%	GCM31A5C2J330JX01#														
				±2%	GCM31A5C3A221GX01#				±2%	GCM31A5C2J390FX01#							
						±5%	GCM31A5C3A221JX01#	±5%			GCM31A5C2J390GX01#						
±1%	GCM31A5C3A221GX01#	±1%	GCM31A5C2J390FX01#														
				±2%	GCM31A5C3A221GX01#				±2%	GCM31A5C2J390GX01#							
						±5%	GCM31A5C3A221JX01#	±5%			GCM31A5C2J390JX01#						

GRT Series
 GCM Series
 GC3 Series
 GCJ Series
 GCQ Series
 GCD Series
 GCE Series
 NMF Series
 KCM Series
 KC3 Series
 KCA Series
 GCB Series
 GCG Series
 ⚠Caution /Notice

Part number # indicates the package specification code.

GCM Series Temperature Compensating Type Part Number List

(→ 3.2×1.6mm)

T max.	Rated Voltage	TC Code	Cap.	Tol.	Part Number
1.0mm	630Vdc	COG	39pF	±2%	GCM31A5C2J390GX01#
				±5%	GCM31A5C2J390JX01#
			47pF	±1%	GCM31A5C2J470FX01#
				±2%	GCM31A5C2J470GX01#
				±5%	GCM31A5C2J470JX01#
				56pF	±1%
			±2%		GCM31A5C2J560GX01#
			±5%		GCM31A5C2J560JX01#
			68pF	±1%	GCM31A5C2J680FX01#
				±2%	GCM31A5C2J680GX01#
				±5%	GCM31A5C2J680JX01#
			82pF	±1%	GCM31A5C2J820FX01#
				±2%	GCM31A5C2J820GX01#
				±5%	GCM31A5C2J820JX01#
			100pF	±1%	GCM31A5C2J101FX01#
				±2%	GCM31A5C2J101GX01#
				±5%	GCM31A5C2J101JX01#
			120pF	±1%	GCM31A5C2J121FX01#
				±2%	GCM31A5C2J121GX01#
				±5%	GCM31A5C2J121JX01#
			150pF	±1%	GCM31A5C2J151FX01#
				±2%	GCM31A5C2J151GX01#
				±5%	GCM31A5C2J151JX01#
			180pF	±1%	GCM31A5C2J181FX01#
				±2%	GCM31A5C2J181GX01#
				±5%	GCM31A5C2J181JX01#
			220pF	±1%	GCM31A5C2J221FX01#
				±2%	GCM31A5C2J221GX01#
				±5%	GCM31A5C2J221JX01#
			270pF	±1%	GCM31A5C2J271FX01#
				±2%	GCM31A5C2J271GX01#
				±5%	GCM31A5C2J271JX01#
			330pF	±1%	GCM31A5C2J331FX01#
				±2%	GCM31A5C2J331GX01#
				±5%	GCM31A5C2J331JX01#
			390pF	±1%	GCM31A5C2J391FX01#
				±2%	GCM31A5C2J391GX01#
				±5%	GCM31A5C2J391JX01#
			470pF	±1%	GCM31A5C2J471FX01#
				±2%	GCM31A5C2J471GX01#
				±5%	GCM31A5C2J471JX01#
				560pF	±1%
			±2%		GCM31A5C2J561GX01#
			±5%		GCM31A5C2J561JX01#
			680pF	±1%	GCM31A5C2J681FX01#
				±2%	GCM31A5C2J681GX01#
				±5%	GCM31A5C2J681JX01#
				820pF	±1%
			±2%		GCM31A5C2J821GX01#
			±5%		GCM31A5C2J821JX01#
			1000pF	±1%	GCM31A5C2J102FX01#
				±2%	GCM31A5C2J102GX01#
				±5%	GCM31A5C2J102JX01#
			1200pF	±1%	GCM31A5C2J122FX01#

T max.	Rated Voltage	TC Code	Cap.	Tol.	Part Number			
1.0mm	630Vdc	COG	1200pF	±2%	GCM31A5C2J122GX01#			
				±5%	GCM31A5C2J122JX01#			
			1500pF	±1%	GCM31A5C2J152FX01#			
				±2%	GCM31A5C2J152GX01#			
				±5%	GCM31A5C2J152JX01#			
				1800pF	±1%	GCM31A5C2J182FX01#		
			±2%		GCM31A5C2J182GX01#			
			±5%		GCM31A5C2J182JX01#			
			U2J	COG	10pF	±5%	GCM31A7U2J100JX01#	
					12pF	±5%	GCM31A7U2J120JX01#	
					15pF	±5%	GCM31A7U2J150JX01#	
					18pF	±5%	GCM31A7U2J180JX01#	
					22pF	±5%	GCM31A7U2J220JX01#	
					27pF	±5%	GCM31A7U2J270JX01#	
					33pF	±5%	GCM31A7U2J330JX01#	
					39pF	±5%	GCM31A7U2J390JX01#	
					47pF	±5%	GCM31A7U2J470JX01#	
					56pF	±5%	GCM31A7U2J560JX01#	
					68pF	±5%	GCM31A7U2J680JX01#	
					82pF	±5%	GCM31A7U2J820JX01#	
					100pF	±5%	GCM31A7U2J101JX01#	
					120pF	±5%	GCM31A7U2J121JX01#	
					150pF	±5%	GCM31A7U2J151JX01#	
					180pF	±5%	GCM31A7U2J181JX01#	
					220pF	±5%	GCM31A7U2J221JX01#	
					270pF	±5%	GCM31A7U2J271JX01#	
					330pF	±5%	GCM31A7U2J331JX01#	
					390pF	±5%	GCM31A7U2J391JX01#	
					470pF	±5%	GCM31A7U2J471JX01#	
					560pF	±5%	GCM31A7U2J561JX01#	
			680pF	±5%	GCM31A7U2J681JX01#			
			820pF	±5%	GCM31A7U2J821JX01#			
			1000pF	±5%	GCM31A7U2J102JX01#			
			1200pF	±5%	GCM31A7U2J122JX01#			
			1500pF	±5%	GCM31A7U2J152JX01#			
			1800pF	±5%	GCM31A7U2J182JX01#			
			2200pF	±5%	GCM31A7U2J222JX01#			
			1.25mm	1000Vdc	COG	560pF	±1%	GCM31B5C3A561FX01#
							±2%	GCM31B5C3A561GX01#
							±5%	GCM31B5C3A561JX01#
						680pF	±1%	GCM31B5C3A681FX01#
							±2%	GCM31B5C3A681GX01#
					±5%	GCM31B5C3A681JX01#		
					U2J	390pF	±5%	GCM31B7U3A391JX01#
						470pF	±5%	GCM31B7U3A471JX01#
						560pF	±5%	GCM31B7U3A561JX01#
						680pF	±5%	GCM31B7U3A681JX01#
			630Vdc	COG		2200pF	±1%	GCM31B5C2J222FX01#
					±2%		GCM31B5C2J222GX01#	
					±5%		GCM31B5C2J222JX01#	
2700pF	±1%	GCM31B5C2J272FX01#						
	±2%	GCM31B5C2J272GX01#						
±5%	GCM31B5C2J272JX01#							
U2J	2700pF	±5%	GCM31B7U2J272JX01#					

Part number # indicates the package specification code.

GRT Series
 GCM Series
 GC3 Series
 GCJ Series
 GCQ Series
 GCD Series
 GCE Series
 NMF Series
 KCM Series
 KC3 Series
 KCA Series
 GCB Series
 GCG Series
 ⚠Caution /Notice

GCM Series Temperature Compensating Type Part Number List

(→ 3.2×1.6mm)

T max.	Rated Voltage	TC Code	Cap.	Tol.	Part Number		
1.25mm	630Vdc	U2J	3300pF	±5%	GCM31B7U2J332JX01#		
				COG	12000pF	±1%	GCM31B5C2E123FX01#
						±2%	GCM31B5C2E123GX01#
		±5%	GCM31B5C2E123JX01#				
		U2J	6800pF	±5%	GCM31B7U2E682JX01#		
				8200pF	±5%	GCM31B7U2E822JX01#	
	10000pF				±5%	GCM31B7U2E103JX01#	
	50Vdc	COG	43000pF	±1%	GCM31M5C1H433FA16#		
				±2%	GCM31M5C1H433GA16#		
				±5%	GCM31M5C1H433JA16#		
			47000pF	±1%	GCM31M5C1H473FA16#		
				±2%	GCM31M5C1H473GA16#		
				±5%	GCM31M5C1H473JA16#		
		51000pF	±1%	GCM31M5C1H513FA16#			
			±2%	GCM31M5C1H513GA16#			
			±5%	GCM31M5C1H513JA16#			
		56000pF	±1%	GCM31M5C1H563FA16#			
			±2%	GCM31M5C1H563GA16#			
			±5%	GCM31M5C1H563JA16#			
	1.8mm		1000Vdc	COG	820pF	±1%	GCM31C5C3A821FX03#
						±2%	GCM31C5C3A821GX03#
						±5%	GCM31C5C3A821JX03#
		1000pF			±1%	GCM31C5C3A102FX03#	
					±2%	GCM31C5C3A102GX03#	
±5%					GCM31C5C3A102JX03#		
U2J		820pF		±5%	GCM31C7U3A821JX03#		
		1000pF		±5%	GCM31C7U3A102JX03#		
630Vdc		COG		3300pF	±1%	GCM31C5C2J332FX03#	
					±2%	GCM31C5C2J332GX03#	
					±5%	GCM31C5C2J332JX03#	
				3900pF	±1%	GCM31C5C2J392FX03#	
	±2%		GCM31C5C2J392GX03#				
	±5%		GCM31C5C2J392JX03#				
	4700pF		±1%	GCM31C5C2J472FX03#			
			±2%	GCM31C5C2J472GX03#			
			±5%	GCM31C5C2J472JX03#			
	5600pF		±1%	GCM31C5C2J562FX03#			
			±2%	GCM31C5C2J562GX03#			
			±5%	GCM31C5C2J562JX03#			
	6800pF		±1%	GCM31C5C2J682FX03#			
			±2%	GCM31C5C2J682GX03#			
			±5%	GCM31C5C2J682JX03#			
	8200pF		±1%	GCM31C5C2J822FX03#			
			±2%	GCM31C5C2J822GX03#			
			±5%	GCM31C5C2J822JX03#			
10000pF	±1%	GCM31C5C2J103FX03#					
	±2%	GCM31C5C2J103GX03#					
	±5%	GCM31C5C2J103JX03#					
U2J	3900pF	±5%	GCM31C7U2J392JX03#				
	4700pF	±5%	GCM31C7U2J472JX03#				
250Vdc	COG	15000pF	±1%	GCM31C5C2E153FX03#			
			±2%	GCM31C5C2E153GX03#			
			±5%	GCM31C5C2E153JX03#			
		18000pF	±1%	GCM31C5C2E183FX03#			

T max.	Rated Voltage	TC Code	Cap.	Tol.	Part Number			
1.8mm	250Vdc	COG	18000pF	±2%	GCM31C5C2E183GX03#			
				±5%	GCM31C5C2E183JX03#			
				22000pF	±1%	GCM31C5C2E223FX03#		
					±2%	GCM31C5C2E223GX03#		
					±5%	GCM31C5C2E223JX03#		
				100Vdc	COG	62000pF	±5%	GCM31C5C2A623JE02#
			68000pF				±5%	GCM31C5C2A683JE02#
			75000pF				±5%	GCM31C5C2A753JE02#
			82000pF			±5%	GCM31C5C2A823JE02#	
						91000pF	±5%	GCM31C5C2A913JE02#
						0.10μF	±5%	GCM31C5C2A104JE02#
			50Vdc	COG	62000pF	±1%	GCM31C5C1H623FA16#	
	±2%	GCM31C5C1H623GA16#						
	±5%	GCM31C5C1H623JA16#						
	68000pF	±1%			GCM31C5C1H683FA16#			
		±2%			GCM31C5C1H683GA16#			
		±5%			GCM31C5C1H683JA16#			
	75000pF	±1%			GCM31C5C1H753FA16#			
		±2%			GCM31C5C1H753GA16#			
		±5%			GCM31C5C1H753JA16#			
	82000pF	±1%			GCM31C5C1H823FA16#			
		±2%			GCM31C5C1H823GA16#			
		±5%			GCM31C5C1H823JA16#			
	91000pF	±1%	GCM31C5C1H913FA16#					
±2%		GCM31C5C1H913GA16#						
±5%		GCM31C5C1H913JA16#						
0.10μF	±1%	GCM31C5C1H104FA16#						
	±2%	GCM31C5C1H104GA16#						
	±5%	GCM31C5C1H104JA16#						

3.2×2.5mm

T max.	Rated Voltage	TC Code	Cap.	Tol.	Part Number
1.0mm	630Vdc	U2J	1200pF	±5%	GCM32A7U2J122JX01#
			1500pF	±5%	GCM32A7U2J152JX01#
			1800pF	±5%	GCM32A7U2J182JX01#
			2200pF	±5%	GCM32A7U2J222JX01#
1.25mm	1000Vdc	U2J	1200pF	±5%	GCM32B7U3A122JX01#
	630Vdc	U2J	5600pF	±5%	GCM32B7U2J562JX01#
1.5mm	1000Vdc	U2J	1500pF	±5%	GCM32Q7U3A152JX01#
	630Vdc	U2J	6800pF	±5%	GCM32Q7U2J682JX01#
2.0mm	1000Vdc	U2J	1800pF	±5%	GCM32D7U3A182JX01#
			2200pF	±5%	GCM32D7U3A222JX01#
	630Vdc	U2J	8200pF	±5%	GCM32D7U2J822JX01#
			10000pF	±5%	GCM32D7U2J103JX01#
2.85mm	630Vdc	COG	33000pF	±1%	GCM32E5C2J333FX0A#
				±2%	GCM32E5C2J333GX0A#
				±5%	GCM32E5C2J333JX0A#

Part number # indicates the package specification code.

GRT Series
 GCM Series
 GC3 Series
 GCJ Series
 GCQ Series
 GCD Series
 GCE Series
 NMF Series
 KCM Series
 KC3 Series
 KCA Series
 GCB Series
 GCG Series
 ⚠Caution /Notice

GCM Series Temperature Compensating Type Part Number List

4.5×3.2mm

T max.	Rated Voltage	TC Code	Cap.	Tol.	Part Number
1.5mm	1000Vdc	U2J	2700pF	±5%	GCM43Q7U3A272JX01#
			3300pF	±5%	GCM43Q7U3A332JX01#
	630Vdc	U2J	12000pF	±5%	GCM43Q7U2J123JX01#
2.0mm	1000Vdc	U2J	3900pF	±5%	GCM43D7U3A392JX01#
			4700pF	±5%	GCM43D7U3A472JX01#
	630Vdc	U2J	15000pF	±5%	GCM43D7U2J153JX01#
			18000pF	±5%	GCM43D7U2J183JX01#
			22000pF	±5%	GCM43D7U2J223JX01#

5.7×5.0mm

T max.	Rated Voltage	TC Code	Cap.	Tol.	Part Number
1.5mm	1000Vdc	U2J	5600pF	±5%	GCM55Q7U3A562JX01#
			6800pF	±5%	GCM55Q7U3A682JX01#
	630Vdc	U2J	27000pF	±5%	GCM55Q7U2J273JX01#
2.0mm	1000Vdc	U2J	8200pF	±5%	GCM55D7U3A822JX01#
			10000pF	±5%	GCM55D7U3A103JX01#
	630Vdc	U2J	33000pF	±5%	GCM55D7U2J333JX01#
			39000pF	±5%	GCM55D7U2J393JX01#
			47000pF	±5%	GCM55D7U2J473JX01#

GRT Series
 GCM Series
 GC3 Series
 GCJ Series
 GCQ Series
 GCD Series
 GCE Series
 NMF Series
 KCM Series
 KC3 Series
 KCA Series
 GCB Series
 GCG Series
 ⚠Caution /Notice

GCM Series High Dielectric Constant Type Part Number List

0.6×0.3mm

T max.	Rated Voltage	TC Code	Cap.	Tol.	Part Number
0.33mm	25Vdc	X7R	100pF	±10%	GCM033R71E101KA03#
				±20%	GCM033R71E101MA03#
			120pF	±10%	GCM033R71E121KA03#
				±20%	GCM033R71E121MA03#
			150pF	±10%	GCM033R71E151KA03#
				±20%	GCM033R71E151MA03#
			180pF	±10%	GCM033R71E181KA03#
				±20%	GCM033R71E181MA03#
			220pF	±10%	GCM033R71E221KA03#
				±20%	GCM033R71E221MA03#
			270pF	±10%	GCM033R71E271KA03#
				±20%	GCM033R71E271MA03#
			330pF	±10%	GCM033R71E331KA03#
				±20%	GCM033R71E331MA03#
			390pF	±10%	GCM033R71E391KA03#
				±20%	GCM033R71E391MA03#
			470pF	±10%	GCM033R71E471KA03#
				±20%	GCM033R71E471MA03#
			560pF	±10%	GCM033R71E561KA03#
				±20%	GCM033R71E561MA03#
			680pF	±10%	GCM033R71E681KA03#
				±20%	GCM033R71E681MA03#
			820pF	±10%	GCM033R71E821KA03#
				±20%	GCM033R71E821MA03#
			1000pF	±10%	GCM033R71E102KA03#
				±20%	GCM033R71E102MA03#
			1200pF	±10%	GCM033R71E122KA03#
				±20%	GCM033R71E122MA03#
			1500pF	±10%	GCM033R71E152KA03#
				±20%	GCM033R71E152MA03#
			1800pF	±10%	GCM033R71E182KE02#
				±10%	GCM033R71E222KE02#
			2200pF	±10%	GCM033R71E222KE02#
				±10%	GCM033R71E272KE02#
			2700pF	±10%	GCM033R71E272KE02#
				±10%	GCM033R71E332KE02#
	16Vdc	X7R	330pF	±10%	GCM033R71C331KA03#
				±10%	GCM033R71C681KA03#
			1800pF	±10%	GCM033R71C182KA55#
				±20%	GCM033R71C182MA55#
			2200pF	±10%	GCM033R71C222KA55#
				±20%	GCM033R71C222MA55#
	2700pF	±10%	GCM033R71C272KA55#		
		±20%	GCM033R71C272MA55#		
	3300pF	±10%	GCM033R71C332KA55#		
		±20%	GCM033R71C332MA55#		
	10Vdc	X7R	1200pF	±10%	GCM033R71A122KA03#
				±20%	GCM033R71A122MA03#
			1500pF	±10%	GCM033R71A152KA03#
				±20%	GCM033R71A152MA03#
			1800pF	±10%	GCM033R71A182KA03#
				±20%	GCM033R71A182MA03#
			2200pF	±10%	GCM033R71A222KA03#
				±20%	GCM033R71A222MA03#

T max.	Rated Voltage	TC Code	Cap.	Tol.	Part Number
0.33mm	10Vdc	X7R	2700pF	±10%	GCM033R71A272KA03#
				±20%	GCM033R71A272MA03#
			3300pF	±10%	GCM033R71A332KA03#
				±20%	GCM033R71A332MA03#
			3900pF	±10%	GCM033R71A392KA03#
				±20%	GCM033R71A392MA03#
			4700pF	±10%	GCM033R71A472KA03#
				±20%	GCM033R71A472MA03#
			5600pF	±10%	GCM033R71A562KA03#
				±20%	GCM033R71A562MA03#
			6800pF	±10%	GCM033R71A682KA03#
				±20%	GCM033R71A682MA03#
			8200pF	±10%	GCM033R71A822KA03#
				±20%	GCM033R71A822MA03#
			10000pF	±10%	GCM033R71A103KA03#
				±20%	GCM033R71A103MA03#

1.0×0.5mm

T max.	Rated Voltage	TC Code	Cap.	Tol.	Part Number
0.55mm	100Vdc	X7R	220pF	±10%	GCM155R72A221KA37#
				±20%	GCM155R72A221MA37#
			270pF	±10%	GCM155R72A271KA37#
				±20%	GCM155R72A271MA37#
			330pF	±10%	GCM155R72A331KA37#
				±20%	GCM155R72A331MA37#
			390pF	±10%	GCM155R72A391KA37#
				±20%	GCM155R72A391MA37#
			470pF	±10%	GCM155R72A471KA37#
				±20%	GCM155R72A471MA37#
			560pF	±10%	GCM155R72A561KA37#
				±20%	GCM155R72A561MA37#
			680pF	±10%	GCM155R72A681KA37#
				±20%	GCM155R72A681MA37#
			820pF	±10%	GCM155R72A821KA37#
				±20%	GCM155R72A821MA37#
			1000pF	±10%	GCM155R72A102KA37#
				±20%	GCM155R72A102MA37#
			1200pF	±10%	GCM155R72A122KA37#
				±20%	GCM155R72A122MA37#
			1500pF	±10%	GCM155R72A152KA37#
				±20%	GCM155R72A152MA37#
			1800pF	±10%	GCM155R72A182KA37#
				±20%	GCM155R72A182MA37#
			2200pF	±10%	GCM155R72A222KA37#
				±20%	GCM155R72A222MA37#
			2700pF	±10%	GCM155R72A272KA37#
				±20%	GCM155R72A272MA37#
			3300pF	±10%	GCM155R72A332KA37#
				±20%	GCM155R72A332MA37#
			3900pF	±10%	GCM155R72A392KA37#
				±20%	GCM155R72A392MA37#
			4700pF	±10%	GCM155R72A472KA37#

Part number # indicates the package specification code.

GCM Series High Dielectric Constant Type Part Number List

(→ 1.0×0.5mm)

T max.	Rated Voltage	TC Code	Cap.	Tol.	Part Number	T max.	Rated Voltage	TC Code	Cap.	Tol.	Part Number	
0.55mm	100Vdc	X7R	4700pF	±20%	GCM155R72A472MA37#	0.55mm	50Vdc	X7R	820pF	±20%	GCM155R71H821MA37#	
				±10%	GCM155L81H221KA37#				1000pF	±10%	GCM155R71H102KA37#	
	±20%	GCM155L81H221MA37#	±20%	GCM155R71H102MA37#	±10%		GCM155R71H102MA37#					
	±10%	GCM155L81H271KA37#	1200pF	±10%	GCM155R71H122KA37#							
	±20%	GCM155L81H271MA37#	±20%	GCM155R71H122MA37#	±10%		GCM155R71H122MA37#					
	±10%	GCM155L81H331KA37#	1500pF	±10%	GCM155R71H152KA37#							
	±20%	GCM155L81H331MA37#	±20%	GCM155R71H152MA37#	±10%		GCM155R71H152MA37#					
	±10%	GCM155L81H391KA37#	1800pF	±10%	GCM155R71H182KA37#							
	±20%	GCM155L81H391MA37#	±20%	GCM155R71H182MA37#	±10%		GCM155R71H182MA37#					
	±10%	GCM155L81H471KA37#	2200pF	±10%	GCM155R71H222KA37#							
	±20%	GCM155L81H471MA37#	±20%	GCM155R71H222MA37#	±10%		GCM155R71H222MA37#					
	±10%	GCM155L81H561KA37#	2700pF	±10%	GCM155R71H272KA37#							
	±20%	GCM155L81H561MA37#	±20%	GCM155R71H272MA37#	±10%		GCM155R71H272MA37#					
	±10%	GCM155L81H681KA37#	3300pF	±10%	GCM155R71H332KA37#							
	±20%	GCM155L81H681MA37#	±20%	GCM155R71H332MA37#	±10%		GCM155R71H332MA37#					
	±10%	GCM155L81H821KA37#	3900pF	±10%	GCM155R71H392KA37#							
	±20%	GCM155L81H821MA37#	±20%	GCM155R71H392MA37#	±10%		GCM155R71H392MA37#					
	±10%	GCM155L81H102KA37#	4700pF	±10%	GCM155R71H472KA37#							
	±20%	GCM155L81H102MA37#	±20%	GCM155R71H472MA37#	±10%		GCM155R71H472MA37#					
	±10%	GCM155L81H122KA37#	5600pF	±10%	GCM155R71H562KA55#							
	±20%	GCM155L81H122MA37#	±20%	GCM155R71H562MA55#	±10%		GCM155R71H562MA55#					
	±10%	GCM155L81H152KA37#	6800pF	±10%	GCM155R71H682KA55#							
	±20%	GCM155L81H152MA37#	±20%	GCM155R71H682MA55#	±10%		GCM155R71H682MA55#					
	±10%	GCM155L81H182KA37#	8200pF	±10%	GCM155R71H822KA55#							
	±20%	GCM155L81H182MA37#	±20%	GCM155R71H822MA55#	±10%		GCM155R71H822MA55#					
	±10%	GCM155L81H222KA37#	2200pF	±10%	GCM155R71H103KA55#							
	±20%	GCM155L81H222MA37#	±20%	GCM155R71H103MA55#	±10%		GCM155R71H103MA55#					
	±10%	GCM155L81H272KA37#	2700pF	±10%	GCM155R71H123KA55#							
	±20%	GCM155L81H272MA37#	±20%	GCM155R71H123MA55#	±10%		GCM155R71H123MA55#					
	±10%	GCM155L81H332KA37#	3300pF	±10%	GCM155R71H153KA55#							
	±20%	GCM155L81H332MA37#	±20%	GCM155R71H153MA55#	±10%		GCM155R71H153MA55#					
	±10%	GCM155L81H392KA37#	3900pF	±10%	GCM155R71H183KA55#							
	±20%	GCM155L81H392MA37#	±20%	GCM155R71H183MA55#	±10%		GCM155R71H183MA55#					
	±10%	GCM155L81H472KA37#	4700pF	±10%	GCM155R71H223KA55#							
	±20%	GCM155L81H472MA37#	±20%	GCM155R71H223MA55#	±10%		GCM155R71H223MA55#					
	±10%	GCM155L8EH333KE07#	33000pF	±10%	GCM155R71H333KE02#							
					±20%		GCM155R71H333ME02#					
	±10%	GCM155L8EH473KE07#	47000pF	±10%	GCM155R71H333ME02#							
					±20%		GCM155R71H333ME02#					
	±10%	GCM155L8EH683KE07#	68000pF	±10%	GCM155R71H473KE02#							
					±20%		GCM155R71H473ME02#					
	±10%	GCM155L8EH104KE07#	0.10μF	±10%	GCM155R71H473ME02#							
					±20%		GCM155R71H473ME02#					
	X7R	50Vdc	X8L	220pF	±10%		GCM155R71H221KA37#	25Vdc	X8L	5600pF	±10%	GCM155L81E562KA37#
					±20%		GCM155R71H221MA37#				±20%	GCM155L81E562MA37#
					±10%		GCM155R71H271KA37#				±10%	GCM155L81E682KA37#
±20%					GCM155R71H271MA37#	±20%	GCM155L81E682MA37#					
±10%					GCM155R71H331KA37#	8200pF	±10%				GCM155L81E822KA37#	
±20%					GCM155R71H331MA37#	±20%	GCM155L81E822MA37#					
±10%					GCM155R71H391KA37#	10000pF	±10%				GCM155L81E103KA37#	
±20%					GCM155R71H391MA37#	±20%	GCM155L81E103MA37#					
±10%					GCM155R71H471KA37#	0.10μF	±10%				GCM155L81E104KE02#	
±20%					GCM155R71H471MA37#	±20%	GCM155L81E104ME02#					
±10%					GCM155R71H561KA37#	±10%	GCM155R71E472KA37#					
±20%					GCM155R71H561MA37#	±20%	GCM155R71E472MA37#					
±10%					GCM155R71H681KA37#	5600pF	±10%				GCM155R71E562KA37#	
±20%					GCM155R71H681MA37#	±20%	GCM155R71E562MA37#					
±10%	GCM155R71H821KA37#	820pF	±10%	GCM155R71E822KA37#								
±20%	GCM155R71H821MA37#	±20%	GCM155R71E822MA37#									

Part number # indicates the package specification code.

GRT Series
 GCM Series
 GC3 Series
 GCJ Series
 GCQ Series
 GCD Series
 GCE Series
 NMF Series
 KCM Series
 KC3 Series
 KCA Series
 GCB Series
 GCG Series
 ⚠Caution / Notice

GCM Series High Dielectric Constant Type Part Number List

(→ 1.0×0.5mm)

T max.	Rated Voltage	TC Code	Cap.	Tol.	Part Number
0.55mm	25Vdc	X7R	5600pF	±20%	GCM155R71E562MA37#
			6800pF	±10%	GCM155R71E682KA37#
				±20%	GCM155R71E682MA37#
				±20%	GCM155R71E682MA37#
			8200pF	±10%	GCM155R71E822KA37#
				±20%	GCM155R71E822MA37#
			10000pF	±10%	GCM155R71E103KA37#
				±20%	GCM155R71E103MA37#
			12000pF	±10%	GCM155R71E123KA55#
				±20%	GCM155R71E123MA55#
			15000pF	±10%	GCM155R71E153KA55#
				±20%	GCM155R71E153MA55#
			18000pF	±10%	GCM155R71E183KA55#
				±20%	GCM155R71E183MA55#
			22000pF	±10%	GCM155R71E223KA55#
				±20%	GCM155R71E223MA55#
			27000pF	±10%	GCM155R71E273KA55#
				±20%	GCM155R71E273MA55#
	33000pF	±10%	GCM155R71E333KA55#		
		±20%	GCM155R71E333MA55#		
	39000pF	±10%	GCM155R71E393KA55#		
		±20%	GCM155R71E393MA55#		
	47000pF	±10%	GCM155R71E473KA55#		
		±20%	GCM155R71E473MA55#		
	0.10μF	±10%	GCM155R71E104KE02#		
	16Vdc	X8L	15000pF	±10%	GCM155L81C153KA37#
				±20%	GCM155L81C153MA37#
			18000pF	±10%	GCM155L81C183KA37#
				±20%	GCM155L81C183MA37#
			22000pF	±10%	GCM155L81C223KA37#
				±20%	GCM155L81C223MA37#
			27000pF	±10%	GCM155L81C273KA37#
				±20%	GCM155L81C273MA37#
			33000pF	±10%	GCM155L81C333KA37#
		±20%		GCM155L81C333MA37#	
		39000pF	±10%	GCM155L81C393KA37#	
±20%			GCM155L81C393MA37#		
47000pF		±10%	GCM155L81C473KA37#		
		±20%	GCM155L81C473MA37#		
X7R		27000pF	±10%	GCM155R71C273KA37#	
			±20%	GCM155R71C273MA37#	
		33000pF	±10%	GCM155R71C333KA37#	
			±20%	GCM155R71C333MA37#	
	39000pF	±10%	GCM155R71C393KA37#		
		±20%	GCM155R71C393MA37#		
	47000pF	±10%	GCM155R71C473KA37#		
		±20%	GCM155R71C473MA37#		
	56000pF	±10%	GCM155R71C563KA55#		
±20%		GCM155R71C563MA55#			
68000pF	±10%	GCM155R71C683KA55#			
	±20%	GCM155R71C683MA55#			
82000pF	±10%	GCM155R71C823KA55#			
	±20%	GCM155R71C823MA55#			
0.10μF	±10%	GCM155R71C104KA55#			
	±20%	GCM155R71C104MA55#			

T max.	Rated Voltage	TC Code	Cap.	Tol.	Part Number
0.55mm	16Vdc	X7R	0.15μF	±10%	GCM155R71C154KE02#
				±20%	GCM155R71C154ME02#
				±20%	GCM155R71C154ME02#
			0.22μF	±10%	GCM155R71C224KE02#
				±20%	GCM155R71C224ME02#
				±20%	GCM155R71C224ME02#
10Vdc	X7R	0.10μF	±10%	GCM155R71A104KA55#	
			±20%	GCM155R71A104KA55#	
0.6mm	10Vdc	X7S	0.47μF	±10%	GCM155C71A474KE36#
				±20%	GCM155C71A474ME36#
0.7mm	10Vdc	X7S	0.68μF	±10%	GCM155C71A684KE38#
				±20%	GCM155C71A684ME38#
			1.0μF	±10%	GCM155C71A105KE38#
				±20%	GCM155C71A105ME38#

1.6×0.8mm

T max.	Rated Voltage	TC Code	Cap.	Tol.	Part Number	
0.9mm	100Vdc	X8R	1000pF	±10%	GCM188R92A102KA37#	
				±20%	GCM188R92A102MA37#	
			1500pF	±10%	GCM188R92A152KA37#	
				±20%	GCM188R92A152MA37#	
			2200pF	±10%	GCM188R92A222KA37#	
				±20%	GCM188R92A222MA37#	
			3300pF	±10%	GCM188R92A332KA37#	
				±20%	GCM188R92A332MA37#	
			4700pF	±10%	GCM188R92A472KA37#	
				±20%	GCM188R92A472MA37#	
			6800pF	±10%	GCM188R92A682KA37#	
				±20%	GCM188R92A682MA37#	
			10000pF	±10%	GCM188R92A103KA37#	
				±20%	GCM188R92A103MA37#	
			X7R	5600pF	±10%	GCM188R72A562KA37#
					±20%	GCM188R72A562MA37#
				6800pF	±10%	GCM188R72A682KA37#
					±20%	GCM188R72A682MA37#
		8200pF		±10%	GCM188R72A822KA37#	
				±20%	GCM188R72A822MA37#	
		10000pF		±10%	GCM188R72A103KA37#	
				±20%	GCM188R72A103MA37#	
		12000pF		±10%	GCM188R72A123KA37#	
			±20%	GCM188R72A123MA37#		
		15000pF	±10%	GCM188R72A153KA37#		
			±20%	GCM188R72A153MA37#		
		18000pF	±10%	GCM188R72A183KA37#		
			±20%	GCM188R72A183MA37#		
		22000pF	±10%	GCM188R72A223KA37#		
			±20%	GCM188R72A223MA37#		
		50Vdc	X8L	5600pF	±10%	GCM188L81H562KA03#
					±20%	GCM188L81H562MA03#
				6800pF	±10%	GCM188L81H682KA03#
					±20%	GCM188L81H682MA03#
				8200pF	±10%	GCM188L81H822KA03#
					±20%	GCM188L81H822MA03#
10000pF	±10%	GCM188L81H103KA03#				
	±20%	GCM188L81H103MA03#				

Part number # indicates the package specification code.

GCM Series High Dielectric Constant Type Part Number List

(→ 1.6×0.8mm)

T max.	Rated Voltage	TC Code	Cap.	Tol.	Part Number	
0.9mm	50Vdc	X8L	12000pF	±10%	GCM188L81H123KA37#	
				±20%	GCM188L81H123MA37#	
			15000pF	±10%	GCM188L81H153KA37#	
				±20%	GCM188L81H153MA37#	
			18000pF	±10%	GCM188L81H183KA37#	
				±20%	GCM188L81H183MA37#	
			22000pF	±10%	GCM188L81H223KA37#	
				±20%	GCM188L81H223MA37#	
			27000pF	±10%	GCM188L81H273KA55#	
				±20%	GCM188L81H273MA55#	
			33000pF	±10%	GCM188L81H333KA55#	
				±20%	GCM188L81H333MA55#	
			39000pF	±10%	GCM188L81H393KA55#	
				±20%	GCM188L81H393MA55#	
			47000pF	±10%	GCM188L81H473KA55#	
				±20%	GCM188L81H473MA55#	
			56000pF	±10%	GCM188L81H563KA57#	
				±20%	GCM188L81H563MA57#	
			68000pF	±10%	GCM188L81H683KA57#	
				±20%	GCM188L81H683MA57#	
			82000pF	±10%	GCM188L81H823KA57#	
				±20%	GCM188L81H823MA57#	
			0.10μF	±10%	GCM188L81H104KA57#	
				±20%	GCM188L81H104MA57#	
		X8R	1000pF	±10%	GCM188R91H102KA37#	
				±20%	GCM188R91H102MA37#	
			1500pF	±10%	GCM188R91H152KA37#	
				±20%	GCM188R91H152MA37#	
			2200pF	±10%	GCM188R91H222KA37#	
				±20%	GCM188R91H222MA37#	
			3300pF	±10%	GCM188R91H332KA37#	
				±20%	GCM188R91H332MA37#	
			4700pF	±10%	GCM188R91H472KA37#	
				±20%	GCM188R91H472MA37#	
			6800pF	±10%	GCM188R91H682KA37#	
				±20%	GCM188R91H682MA37#	
			10000pF	±10%	GCM188R91H103KA37#	
				±20%	GCM188R91H103MA37#	
			15000pF	±10%	GCM188R91H153KA37#	
				±20%	GCM188R91H153MA37#	
			22000pF	±10%	GCM188R91H223KA37#	
				±20%	GCM188R91H223MA37#	
			33000pF	±10%	GCM188R91H333KA37#	
				±20%	GCM188R91H333MA37#	
			47000pF	±10%	GCM188R91H473KA37#	
				±20%	GCM188R91H473MA37#	
			X7R	0.15μF	±10%	GCM188R71H154KA64#
					±20%	GCM188R71H154MA64#
0.22μF	±10%	GCM188R71H224KA64#				
	±20%	GCM188R71H224MA64#				
25Vdc	X8L	0.22μF	±10%	GCM188L81E224KA64#		
			±20%	GCM188L81E224MA64#		
	X8R	68000pF	±10%	GCM188R91E683KA37#		
			±20%	GCM188R91E683MA37#		
0.10μF	±10%	GCM188R91E104KA37#				
	±20%	GCM188R91E104MA37#				

T max.	Rated Voltage	TC Code	Cap.	Tol.	Part Number	
0.9mm	25Vdc	X8R	0.10μF	±20%	GCM188R91E104MA37#	
				±10%	GCM188R71E124KA37#	
			0.12μF	±10%	GCM188R71E124MA37#	
				±20%	GCM188R71E124KA37#	
			0.15μF	±10%	GCM188R71E154KA37#	
				±20%	GCM188R71E154MA37#	
		0.18μF	±10%	GCM188R71E184KA55#		
			±20%	GCM188R71E184MA55#		
		0.22μF	±10%	GCM188R71E224KA55#		
			±20%	GCM188R71E224MA55#		
		0.47μF	±10%	GCM188R71E474KA64#		
			±20%	GCM188R71E474MA64#		
		1.0μF	±10%	GCM188R71E105KA64#		
			±20%	GCM188R71E105MA64#		
		16Vdc	X8L	0.12μF	±10%	GCM188L81C124KA37#
					±20%	GCM188L81C124MA37#
				0.15μF	±10%	GCM188L81C154KA37#
					±20%	GCM188L81C154MA37#
	0.18μF			±10%	GCM188L81C184KA37#	
				±20%	GCM188L81C184MA37#	
	0.22μF			±10%	GCM188L81C224KA37#	
				±20%	GCM188L81C224MA37#	
	X7R			0.27μF	±10%	GCM188R71C274KA37#
					±20%	GCM188R71C274MA37#
				0.33μF	±10%	GCM188R71C334KA37#
					±20%	GCM188R71C334MA37#
			0.39μF	±10%	GCM188R71C394KA55#	
				±20%	GCM188R71C394MA55#	
	0.47μF		±10%	GCM188R71C474KA55#		
			±20%	GCM188R71C474MA55#		
	1.0μF		±10%	GCM188R71C105KA64#		
			±20%	GCM188R71C105MA64#		
	6.3Vdc	X7S	0.68μF	±10%	GCM188C71C684KA64#	
				±20%	GCM188C71C684MA64#	
	1.0mm	6.3Vdc	X7R	2.2μF	±10%	GCM188R70J225KE22#
					±20%	GCM188R70J225ME22#
4Vdc		X7T	10μF	±20%	GCM188D70J106ME36#	
				±20%	GCM188D70G106ME36#	

2.0×1.25mm

T max.	Rated Voltage	TC Code	Cap.	Tol.	Part Number
0.95mm	100Vdc	X8R	10000pF	±10%	GCM219R92A103KA37#
				±20%	GCM219R92A103MA37#
			15000pF	±10%	GCM219R92A153KA37#
				±20%	GCM219R92A153MA37#
			22000pF	±10%	GCM219R92A223KA37#
				±20%	GCM219R92A223MA37#
		X7R	27000pF	±10%	GCM219R72A273KA37#
				±20%	GCM219R72A273MA37#
			33000pF	±10%	GCM219R72A333KA37#
				±20%	GCM219R72A333MA37#
			39000pF	±10%	GCM219R72A393KA37#
				±20%	GCM219R72A393MA37#

Part number # indicates the package specification code.

GRT Series
 GCM Series
 GC3 Series
 GCJ Series
 GCQ Series
 GCD Series
 GCE Series
 NMF Series
 KCM Series
 KC3 Series
 KCA Series
 GCB Series
 GCG Series
 ⚠Caution /Notice

GCM Series High Dielectric Constant Type Part Number List

(→ 2.0×1.25mm)

T max.	Rated Voltage	TC Code	Cap.	Tol.	Part Number	T max.	Rated Voltage	TC Code	Cap.	Tol.	Part Number			
0.95mm	50Vdc	X8R	10000pF	±10%	GCM219R91H103KA37#	1.4mm	50Vdc	X7R	1.0μF	±10%	GCM21BR71H105KA03#			
				±20%	GCM219R91H103MA37#					±20%	GCM21BR71H105MA03#			
			15000pF	±10%	GCM219R91H153KA37#				35Vdc	X8L	2.2μF	±10%	GCM21BL8EG225KE07#	D4
				±20%	GCM219R91H153MA37#							X7R	0.68μF	±10%
			22000pF	±10%	GCM219R91H223KA37#					±20%	GCM21BR7YA684MA55#			1.0μF
				±20%	GCM219R91H223MA37#					±20%	GCM21BR7YA105MA55#	±20%	GCM21BR7YA105MA55#	
	X7R	0.33μF	±10%	GCM219R71H334KA55#	X7S		2.2μF	±10%		GCM21BC7YA225KE02#				
			±20%	GCM219R71H334MA55#				±20%		GCM21BC7YA225ME02#				
	25Vdc	X7R	0.47μF	±10%	GCM219R71E474KA55#		25Vdc	X8L	0.27μF	±10%	GCM21BL81E274KA37#			
				±20%	GCM219R71E474MA55#					±20%	GCM21BL81E274MA37#			
	16Vdc	X7R	1.0μF	±10%	GCM219R71C105KA37#				0.33μF	±10%	GCM21BL81E334KA37#			
				±20%	GCM219R71C105MA37#					±20%	GCM21BL81E334MA37#			
X7R	0.47μF	±10%	GCM21BR71E474KA37#	0.39μF	±10%	GCM21BL81E394KA37#								
		±20%	GCM21BR71E474MA37#		±20%	GCM21BL81E394MA37#								
X7R	1.0μF	±10%	GCM21BR71C105KA37#	0.47μF	±10%	GCM21BL81E474KA37#								
		±20%	GCM21BR71C105MA37#		±20%	GCM21BL81E474MA37#								
X7R	1.0μF	±10%	GCM21BR71C105KA37#	1.5μF	±10%	GCM21BL81E155KA07#		D4						
		±20%	GCM21BR71C105MA37#		±20%	GCM21BL81E155MA07#								
1.4mm	100Vdc	X8R	33000pF	±10%	GCM21BR92A333KA37#	X8R		0.15μF	±10%	GCM21BR91E154KA37#				
				±20%	GCM21BR92A333MA37#				±20%	GCM21BR91E154MA37#				
			47000pF	±10%	GCM21BR92A473KA37#		0.22μF		±10%	GCM21BR91E224KA37#				
				±20%	GCM21BR92A473MA37#				±20%	GCM21BR91E224MA37#				
			X7R	27000pF	±10%				GCM21BR72A273KA37#	0.33μF	±10%	GCM21BR91E334KA37#		
					±20%				GCM21BR72A273MA37#		±20%	GCM21BR91E334MA37#		
		33000pF	±10%	GCM21BR72A333KA37#	X7R			0.27μF	±10%		GCM21BR71E274KA37#			
				±20%					GCM21BR72A333MA37#		±20%	GCM21BR71E274MA37#		
		39000pF	±10%	GCM21BR72A393KA37#			0.33μF	±10%	GCM21BR71E334KA37#					
				±20%				GCM21BR72A393MA37#	±20%		GCM21BR71E334MA37#			
		47000pF	±10%	GCM21BR72A473KA37#			0.39μF	±10%	GCM21BR71E394KA37#					
				±20%				GCM21BR72A473MA37#	±20%	GCM21BR71E394MA37#				
		56000pF	±10%	GCM21BR72A563KA37#	0.47μF		±10%	GCM21BR71E474KA37#						
				±20%			GCM21BR72A563MA37#	±20%	GCM21BR71E474MA37#					
		68000pF	±10%	GCM21BR72A683KA37#	1.5μF		±10%	GCM21BL8EF155KA07#	D4					
				±20%			GCM21BR72A683MA37#	±20%	GCM21BL8EF155MA07#					
		82000pF	±10%	GCM21BR72A823KA37#	X8R		0.15μF	±10%	GCM21BR91E154KA37#					
				±20%				GCM21BR72A823MA37#	±20%	GCM21BR91E154MA37#				
	0.10μF	±10%	GCM21BR72A104KA37#	0.22μF	±10%	GCM21BR91E224KA37#								
			±20%		GCM21BR72A104MA37#	±20%	GCM21BR91E224MA37#							
	50Vdc	X8L	0.12μF	±10%	GCM21BL81H124KA37#	0.33μF	±10%	GCM21BR91E334KA37#						
				±20%	GCM21BL81H124MA37#		±20%	GCM21BR91E334MA37#						
			0.15μF	±10%	GCM21BL81H154KA37#		X7R	0.27μF	±10%	GCM21BR71E274KA37#				
				±20%	GCM21BL81H154MA37#				±20%	GCM21BR71E274MA37#				
			0.18μF	±10%	GCM21BL81H184KA37#			0.33μF	±10%	GCM21BR71E334KA37#				
				±20%	GCM21BL81H184MA37#				±20%	GCM21BR71E334MA37#				
			0.22μF	±10%	GCM21BL81H224KA37#	0.39μF		±10%	GCM21BR71E394KA37#					
				±20%	GCM21BL81H224MA37#			±20%	GCM21BR71E394MA37#					
			0.33μF	±10%	GCM21BL81H334KA56#	0.47μF	±10%	GCM21BR71E474KA37#						
				±20%	GCM21BL81H334MA56#		±20%	GCM21BR71E474MA37#						
			X8R	33000pF	±10%	GCM21BR91H333KA37#	0.56μF	±10%	GCM21BR71E564KA55#					
					±20%	GCM21BR91H333MA37#		±20%	GCM21BR71E564MA55#					
		47000pF		±10%	GCM21BR91H473KA37#	0.68μF		±10%	GCM21BR71E684KA55#					
				±20%	GCM21BR91H473MA37#			±20%	GCM21BR71E684MA55#					
		68000pF		±10%	GCM21BR91H683KA37#			0.82μF	±10%	GCM21BR71E824KA55#				
				±20%	GCM21BR91H683MA37#				±20%	GCM21BR71E824MA55#				
0.10μF		±10%	GCM21BR91H104KA37#	1.0μF	±10%		GCM21BR71E105KA56#							
		±20%	GCM21BR91H104MA37#		±20%		GCM21BR71E105MA56#							
X7R	0.22μF	±10%	GCM21BR71H224KA37#		1.5μF	±10%	GCM21BR71E155KA54#							
		±20%	GCM21BR71H224MA37#			±20%	GCM21BR71E155MA54#							
0.47μF	±10%	GCM21BR71H474KA55#	2.2μF			±10%	GCM21BR71E225KA73#							
	±20%	GCM21BR71H474MA55#				±20%	GCM21BR71E225MA73#							
16Vdc	X8L	0.27μF		±10%		GCM21BL81C274KA37#	X8L	0.27μF	±10%	GCM21BL81C274KA37#				
				±20%		GCM21BL81C274MA37#			±20%	GCM21BL81C274MA37#				
		0.33μF		±10%	GCM21BL81C334KA37#	0.33μF		±10%	GCM21BL81C334KA37#					
				±20%	GCM21BL81C334MA37#			±20%	GCM21BL81C334MA37#					
		0.39μF	±10%	GCM21BL81C394KA37#	0.39μF	±10%		GCM21BL81C394KA37#						
			±20%	GCM21BL81C394MA37#		±20%		GCM21BL81C394MA37#						
	0.47μF	±10%	GCM21BL81C474KA37#	0.47μF	±10%	GCM21BL81C474KA37#								
		±20%	GCM21BL81C474MA37#		±20%	GCM21BL81C474MA37#								

Part number # indicates the package specification code.

GRT Series
 GCM Series
 GC3 Series
 GCJ Series
 GCQ Series
 GCD Series
 GCE Series
 NMF Series
 KCM Series
 KC3 Series
 KCA Series
 GCB Series
 GCG Series
 ⚠Caution /Notice

GCM Series High Dielectric Constant Type Part Number List

(→ 2.0×1.25mm)

T max.	Rated Voltage	TC Code	Cap.	Tol.	Part Number		
1.4mm	16Vdc	X8L	0.56μF	±10%	GCM21BL81C564KA37#		
				±20%	GCM21BL81C564MA37#		
			0.68μF	±10%	GCM21BL81C684KA37#		
				±20%	GCM21BL81C684MA37#		
			0.82μF	±10%	GCM21BL81C824KA37#		
				±20%	GCM21BL81C824MA37#		
		1.0μF	±10%	GCM21BL81C105KA58#			
			±20%	GCM21BL81C105MA58#			
		X7R	1.0μF	±10%	GCM21BR71C105KA58#		
				±20%	GCM21BR71C105MA58#		
			1.5μF	±10%	GCM21BR71C155KA37#		
				±20%	GCM21BR71C155MA37#		
			2.2μF	±10%	GCM21BR71C225KA64#		
				±20%	GCM21BR71C225MA64#		
		3.3μF	±10%	GCM21BR71C335KA73#			
			±20%	GCM21BR71C335MA73#			
		10Vdc	X7R	2.2μF	±10%	GCM21BR71A225KA37#	
					±20%	GCM21BR71A225MA37#	
	10μF		±10%	GCM21BR71A106KE22#			
			±20%	GCM21BR71A106ME22#			
	X7S		4.7μF	±10%	GCM21BC71A475KA73#		
				±20%	GCM21BC71A475MA73#		
	6.3Vdc	X7R	10μF	±10%	GCM21BR70J106KE22#		
				±20%	GCM21BR70J106ME22#		
X7S		1.0μF	±10%	GCM21BC72A105KE36#			
			±20%	GCM21BC72A105ME36#			
		4.7μF	±10%	GCM21BL8EG475KE08#	D4		
			±20%	GCM21BC7YA475KE36#			
1.45mm	100Vdc	X7S	1.0μF	±10%	GCM21BC72A105KE36#		
				±20%	GCM21BC72A105ME36#		
		X8L	4.7μF	±10%	GCM21BL8EG475KE08#	D4	
				±20%	GCM21BC7YA475KE36#		
		X7S	4.7μF	±10%	GCM21BC7YA475ME36#		
				±20%	GCM21BC7YA475ME36#		
	25Vdc	X8L	4.7μF	±10%	GCM21BL8EF475KE08#	D4	
				±20%	GCM21BC71E475KE36#		
		X7S	4.7μF	±10%	GCM21BC71E475ME36#		
				±20%	GCM21BC71E475ME36#		
		X8M	10μF	±10%	GCM21BM8EE106KE08#	D4	
				±20%	GCM21BC71C106KE36#		
X7S	10μF	±10%	GCM21BC71C106KE36#				
		±20%	GCM21BC71C106KE36#				

T max.	Rated Voltage	TC Code	Cap.	Tol.	Part Number		
1.8mm	100Vdc	X8L	2.2μF	±10%	GCM31CL8EL225KE07#	D4	
				±20%	GCM31CC72A225KE02#		
		X7S	2.2μF	±10%	GCM31CC72A225ME02#		
				±20%	GCM31CC72A225ME02#		
		50Vdc	X8L	0.56μF	±10%	GCM31CL81H564KA37#	
					±20%	GCM31CL81H564MA37#	
	0.68μF		±10%	GCM31CL81H684KA37#			
			±20%	GCM31CL81H684MA37#			
	0.82μF		±10%	GCM31CL81H824KA55#			
			±20%	GCM31CL81H824MA55#			
	1.0μF	±10%	GCM31CL81H105KA55#				
		±20%	GCM31CL81H105KA55#				
	25Vdc	X8R	0.47μF	±10%	GCM31CR91H474KA37#		
				±20%	GCM31CR91H474MA37#		
		X7R	1.5μF	±10%	GCM31CR71H155KA55#		
				±20%	GCM31CR71H155MA55#		
		2.2μF	±10%	GCM31CR71H225KA55#			
			±20%	GCM31CR71H225MA55#			
	X7S	4.7μF	±10%	GCM31CC71H475KA03#			
			±20%	GCM31CC71H475MA03#			
	16Vdc	X8R	0.68μF	±10%	GCM31CR91E684KA37#		
				±20%	GCM31CR91E684MA37#		
		1.0μF	±10%	GCM31CR91E105KA37#			
			±20%	GCM31CR91E105KA37#			
X7R		4.7μF	±10%	GCM31CR71E475KA55#			
			±20%	GCM31CR71E475MA55#			
10Vdc	X7R	4.7μF	±10%	GCM31CR71C475KA37#			
			±20%	GCM31CR71C475MA37#			
	10μF	±10%	GCM31CR71C106KA64#				
		±20%	GCM31CR71C106MA64#				
	X7S	2.2μF	±10%	GCM31CR71A226KE02#			
			±20%	GCM31CR71A226ME02#			
6.3Vdc	X7R	2.2μF	±10%	GCM31CR70J226KE23#			
			±20%	GCM31CR70J226ME23#			
	X8M	10μF	±10%	GCM31CM8EG106KE08#	D4		
			±20%	GCM31CD7YA106KE36#			
	X7T	10μF	±10%	GCM31CD7YA106KE36#			
			±20%	GCM31CD7YA106KE36#			
X7S	10μF	±10%	GCM31CC71E106KA03#				
		±20%	GCM31CC71E106MA03#				

3.2×1.6mm

T max.	Rated Voltage	TC Code	Cap.	Tol.	Part Number	
1.25mm	100Vdc	X7R	0.22μF	±10%	GCM31MR72A224KA37#	
				±20%	GCM31MR72A224MA37#	
		X8L	0.39μF	±10%	GCM31ML81H394KA37#	
				±20%	GCM31ML81H394MA37#	
		0.47μF	±10%	GCM31ML81H474KA37#		
			±20%	GCM31ML81H474MA37#		
	50Vdc	X8R	0.22μF	±10%	GCM31MR91H224KA37#	
				±20%	GCM31MR91H224MA37#	
		0.33μF	±10%	GCM31MR91H334KA37#		
			±20%	GCM31MR91H334MA37#		
		X8L	1.0μF	±10%	GCM31ML81E105KA37#	
				±20%	GCM31ML81E105MA37#	
	X8R	0.47μF	±10%	GCM31MR91E474KA37#		
			±20%	GCM31MR91E474MA37#		

3.2×2.5mm

T max.	Rated Voltage	TC Code	Cap.	Tol.	Part Number	
2.2mm	100Vdc	X8L	4.7μF	±10%	GCM32DL8EL475KE07#	D4
				±20%	GCM32DC72A475KE02#	
	X7S	4.7μF	±10%	GCM32DC72A475ME02#		
			±20%	GCM32DC72A475ME02#		
	10Vdc	X8L	10μF	±10%	GCM32DL81A106KA37#	
				±20%	GCM32DL81A106MA37#	
2.7mm	50Vdc	X8L	10μF	±10%	GCM32EL8EH106KA07#	D4
				±20%	GCM32ER71H475KA55#	
	X7R	4.7μF	±10%	GCM32ER71H475MA55#		
			±20%	GCM32ER71H475MA55#		
	X7S	10μF	±10%	GCM32EC71H106KA03#		
			±20%	GCM32EC71H106MA03#		
35Vdc	X7S	10μF	±10%	GCM32EC7YA106KA03#		
			±20%	GCM32EC7YA106MA03#		
25Vdc	X7R	10μF	±10%	GCM32ER71E106KA57#		
			±20%	GCM32ER71E106MA57#		

Part number # indicates the package specification code.

GRT Series
 GCM Series
 GC3 Series
 GCJ Series
 GCQ Series
 GCD Series
 GCE Series
 NMF Series
 KCM Series
 KC3 Series
 KCA Series
 GCB Series
 GCG Series
 ⚠Caution / Notice

GCM Series High Dielectric Constant Type Part Number List

(→ 3.2×2.5mm)

T max.	Rated Voltage	TC Code	Cap.	Tol.	Part Number		
2.7mm	16Vdc	X7R	22μF	±10%	GCM32ER71C226KE19#		
				±20%	GCM32ER71C226ME19#		
	10Vdc	X7R	22μF	±10%	GCM32ER71A226KE12#		
				±20%	GCM32ER71A226ME12#		
	6.3Vdc	X7R	X7S	47μF	±10%	GCM32EC71A476KE02#	
			X7R	47μF	±10%	GCM32ER70J476KE19#	
				±20%	GCM32ER70J476ME19#		
2.85mm	25Vdc	X8L	22μF	±10%	GCM32EL8EF226KE08#	D4	
		X7S	22μF	±10%	GCM32EC71E226KE36#		
	2.5Vdc	X7T	100μF	±20%	GCM32ED70E107ME36#		

GRT Series
 GCM Series
 GC3 Series
 GCJ Series
 GCQ Series
 GCD Series
 GCE Series
 NMF Series
 KCM Series
 KC3 Series
 KCA Series
 GCB Series
 GCG Series
 ⚠Caution /Notice

High Effective Capacitance & High Ripple Current Chip Multilayer Ceramic Capacitors for Automotive

GC3 Series



This is a high ripple resistance product for automotive excellent in DC bias characteristics.

Features

- ① When a DC bias is applied, a capacitance higher than conventional products (X7R characteristics) can be acquired.

When DC600V is applied, about twice the capacitance can be secured.

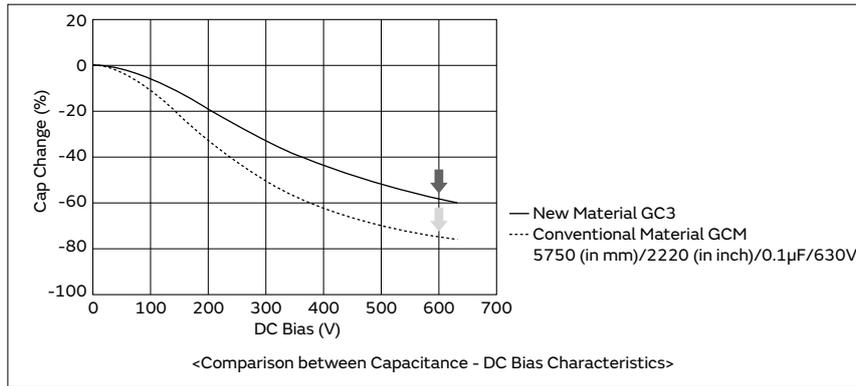

- ② Improved ripple resistance performance compared to conventional products (X7R characteristics).

In the case of a product with a capacitance of 0.1μF, when the exothermic temperature reaches 20°C at frequency f=300kHz, the amount of resistance of a product with conventional material is 1.8Arms; however, the new material is 2.3Arms.

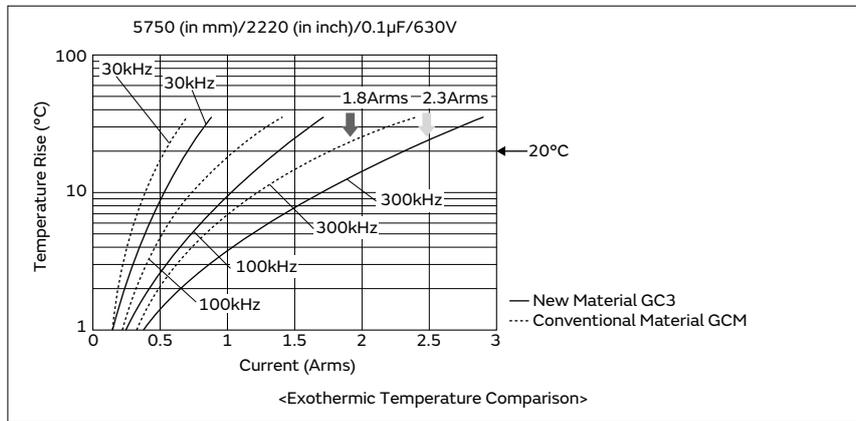

- ③ This product has a noise reduction effect.

Since dielectric materials that enable a reduction of noise are used, this product is more effective for reducing noise compared to the GCM series for automotive.

Specifications

Size	2.0×1.25mm to 5.7×5.0mm
Rated Voltage	250Vdc to 630Vdc
Capacitance	10000pF to 1.0μF
Main Applications	For PFC (Power Factor Correction) Circuits of Power Supplies, EMI Suppression and Smoothing Circuits of automotive

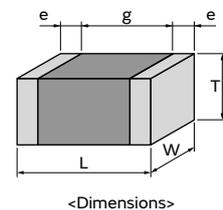

GRT Series
 GCM Series
GC3 Series
 GCJ Series
 GCQ Series
 GCD Series
 GCE Series
 NMF Series
 KCM Series
 KC3 Series
 KCA Series
 GCB Series
 GCG Series
 ⚠Caution /Notice

GC3 Series High Dielectric Constant Type Power-train AEC-Q200 Anti-noise Part Number List

2.0×1.25mm

T max.	Rated Voltage	TC Code	Cap.	Tol.	Part Number
1.0mm	250Vdc	X7T	10000pF	±10%	GC321AD72E103KX01#
			15000pF	±10%	GC321AD72E153KX01#
1.45mm	250Vdc	X7T	22000pF	±10%	GC321BD72E223KX03#

T max.	Rated Voltage	TC Code	Cap.	Tol.	Part Number
2.7mm	250Vdc	X7T	1.0μF	±10%	GC355XD72E105KX05#

3.2×1.6mm

T max.	Rated Voltage	TC Code	Cap.	Tol.	Part Number
1.0mm	450Vdc	X7T	10000pF	±10%	GC331AD72W103KX01#
			15000pF	±10%	GC331AD72W153KX01#
	250Vdc	X7T	33000pF	±10%	GC331AD72E333KX01#
1.25mm	630Vdc	X7T	10000pF	±10%	GC331BD72J103KX01#
	450Vdc	X7T	22000pF	±10%	GC331BD72W223KX01#
			33000pF	±10%	GC331BD72W333KX01#
250Vdc	X7T	47000pF	±10%	GC331BD72E473KX01#	
1.8mm	630Vdc	X7T	15000pF	±10%	GC331CD72J153KX03#
	450Vdc	X7T	47000pF	±10%	GC331CD72W473KX03#
	250Vdc	X7T	68000pF	±10%	GC331CD72E683KX03#

3.2×2.5mm

T max.	Rated Voltage	TC Code	Cap.	Tol.	Part Number
1.5mm	630Vdc	X7T	22000pF	±10%	GC332QD72J223KX01#
	250Vdc	X7T	0.10μF	±10%	GC332QD72E104KX01#
2.0mm	630Vdc	X7T	33000pF	±10%	GC332DD72J333KX01#
			47000pF	±10%	GC332DD72J473KX01#
	450Vdc	X7T	68000pF	±10%	GC332DD72W683KX01#
			0.10μF	±10%	GC332DD72W104KX01#
250Vdc	X7T	0.15μF	±10%	GC332DD72E154KX01#	

4.5×3.2mm

T max.	Rated Voltage	TC Code	Cap.	Tol.	Part Number
1.5mm	250Vdc	X7T	0.22μF	±10%	GC343QD72E224KX01#
2.0mm	630Vdc	X7T	68000pF	±10%	GC343DD72J683KX01#
	450Vdc	X7T	0.15μF	±10%	GC343DD72W154KX01#
	250Vdc	X7T	0.33μF	±10%	GC343DD72E334KX01#

5.7×5.0mm

T max.	Rated Voltage	TC Code	Cap.	Tol.	Part Number
2.0mm	630Vdc	X7T	0.10μF	±10%	GC355DD72J104KX01#
			0.15μF	±10%	GC355DD72J154KX01#
	450Vdc	X7T	0.22μF	±10%	GC355DD72W224KX01#
			0.33μF	±10%	GC355DD72W334KX01#
			0.47μF	±10%	GC355DD72W474KX01#
250Vdc	X7T	0.47μF	±10%	GC355DD72E474KX01#	
		0.68μF	±10%	GC355DD72E684KX01#	
2.7mm	630Vdc	X7T	0.22μF	±10%	GC355XD72J224KX05#

Part number # indicates the package specification code.

Soft Termination Chip Multilayer Ceramic Capacitors for Automotive

GCJ Series



Cracking caused by flexing stress after board mounting is minimized due to resin external electrodes!

Features

① The resin external electrodes suppress cracks by board deflection.

Cracking of the ceramic element is suppressed by the resin of the external electrodes, which releases the stress.

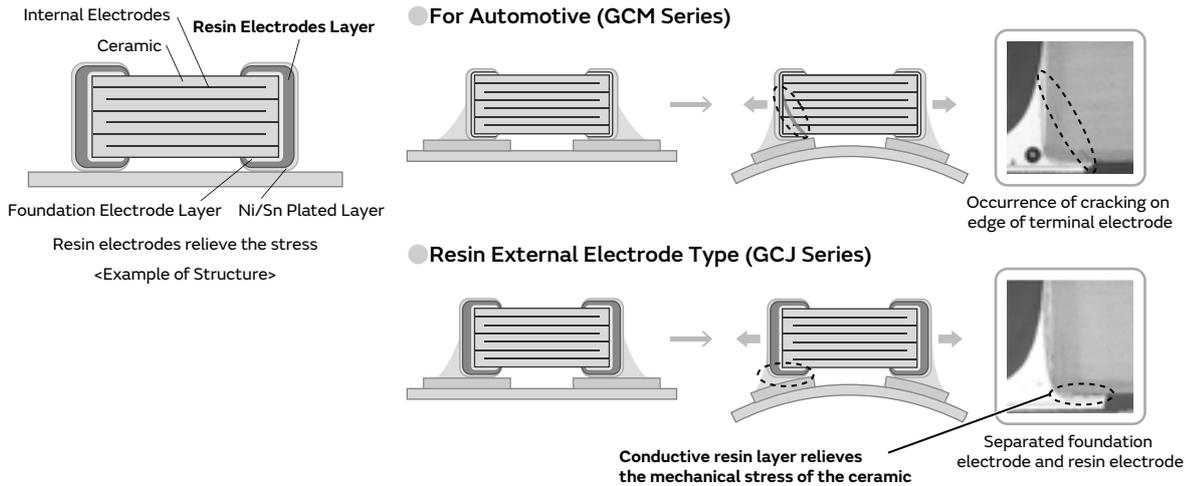

Note: Cracks may occur in the capacitor body if excessive stress beyond the "guaranteed range of board bending strength (*)" provided in the specifications is applied. Capacitors with cracks in them may cause a drop in insulation resistance, which could lead to a short circuit.
 (*) For details on the guaranteed range of board bending strength, check the "Detailed Specification Sheet" on the Product Details Page.

② Suppresses the occurrence of cracking caused by deflection stress at the time of board mounting, etc.

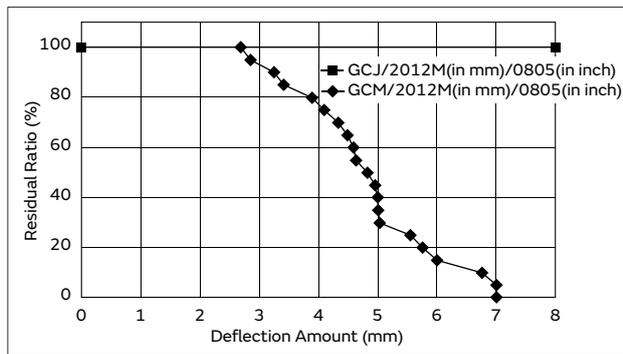

Due to the specification of the measuring instrument, measurements can be performed up 8 mm.

③ Ideal for automotive.

This AEC-Q200 conforming product is ideal for the ECU, control circuits of headlights, etc. of automotive.

Specifications

Size	1.6×0.8mm to 5.7×5.0mm
Rated Voltage	6.3Vdc to 1000Vdc
Capacitance	1000pF to 47μF
Main Applications	Battery Lines and Powertrains for automotive

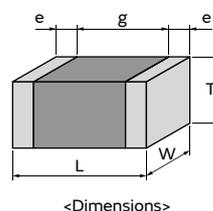

GCJ Series High Dielectric Constant Type Part Number List

1.6×0.8mm

T max.	Rated Voltage	TC Code	Cap.	Tol.	Part Number	
0.9mm	100Vdc	X8L	0.10μF	±10%	GCJ188L8EL104KA07#	D4
		X8R	1000pF	±10%	GCJ188R92A102KA01#	
				±20%	GCJ188R92A102MA01#	
			1200pF	±10%	GCJ188R92A122KA01#	
				±20%	GCJ188R92A122MA01#	
			1500pF	±10%	GCJ188R92A152KA01#	
				±20%	GCJ188R92A152MA01#	
			1800pF	±10%	GCJ188R92A182KA01#	
				±20%	GCJ188R92A182MA01#	
			2200pF	±10%	GCJ188R92A222KA01#	
				±20%	GCJ188R92A222MA01#	
			2700pF	±10%	GCJ188R92A272KA01#	
				±20%	GCJ188R92A272MA01#	
			3300pF	±10%	GCJ188R92A332KA01#	
				±20%	GCJ188R92A332MA01#	
			3900pF	±10%	GCJ188R92A392KA01#	
				±20%	GCJ188R92A392MA01#	
			4700pF	±10%	GCJ188R92A472KA01#	
				±20%	GCJ188R92A472MA01#	
			5600pF	±10%	GCJ188R92A562KA01#	
				±20%	GCJ188R92A562MA01#	
		6800pF	±10%	GCJ188R92A682KA01#		
			±20%	GCJ188R92A682MA01#		
		8200pF	±10%	GCJ188R92A822KA01#		
			±20%	GCJ188R92A822MA01#		
		10000pF	±10%	GCJ188R92A103KA01#		
			±20%	GCJ188R92A103MA01#		
		12000pF	±10%	GCJ188R92A123KA01#		
			±20%	GCJ188R92A123MA01#		
		15000pF	±10%	GCJ188R92A153KA01#		
			±20%	GCJ188R92A153MA01#		
		18000pF	±10%	GCJ188R92A183KA01#		
			±20%	GCJ188R92A183MA01#		
		22000pF	±10%	GCJ188R92A223KA01#		
			±20%	GCJ188R92A223MA01#		
		27000pF	±10%	GCJ188R92A273KA01#		
			±20%	GCJ188R92A273MA01#		
		33000pF	±10%	GCJ188R92A333KA01#		
			±20%	GCJ188R92A333MA01#		
		39000pF	±10%	GCJ188R92A393KA01#		
			±20%	GCJ188R92A393MA01#		
		47000pF	±10%	GCJ188R92A473KA01#		
			±20%	GCJ188R92A473MA01#		
		56000pF	±10%	GCJ188R92A563KA01#		
±20%	GCJ188R92A563MA01#					
68000pF	±10%	GCJ188R92A683KA01#				
	±20%	GCJ188R92A683MA01#				
X7R	1000pF	±10%	GCJ188R72A102KA01#			
		±20%	GCJ188R72A102MA01#			
		1200pF	±10%	GCJ188R72A122KA01#		
			±20%	GCJ188R72A122MA01#		
		1500pF	±10%	GCJ188R72A152KA01#		

T max.	Rated Voltage	TC Code	Cap.	Tol.	Part Number		
0.9mm	100Vdc	X7R	1500pF	±20%	GCJ188R72A152MA01#		
				±10%	GCJ188R72A182KA01#		
			1800pF	±20%	GCJ188R72A182MA01#		
				±10%	GCJ188R72A222KA01#		
			2200pF	±20%	GCJ188R72A222MA01#		
				±10%	GCJ188R72A272KA01#		
			2700pF	±10%	GCJ188R72A272KA01#		
				±20%	GCJ188R72A272MA01#		
			3300pF	±10%	GCJ188R72A332KA01#		
				±20%	GCJ188R72A332MA01#		
			3900pF	±10%	GCJ188R72A392KA01#		
				±20%	GCJ188R72A392MA01#		
			4700pF	±10%	GCJ188R72A472KA01#		
				±20%	GCJ188R72A472MA01#		
			5600pF	±10%	GCJ188R72A562KA01#		
				±20%	GCJ188R72A562MA01#		
			6800pF	±10%	GCJ188R72A682KA01#		
				±20%	GCJ188R72A682MA01#		
			8200pF	±10%	GCJ188R72A822KA01#		
				±20%	GCJ188R72A822MA01#		
			10000pF	±10%	GCJ188R72A103KA01#		
				±20%	GCJ188R72A103MA01#		
			12000pF	±10%	GCJ188R72A123KA01#		
				±20%	GCJ188R72A123MA01#		
			15000pF	±10%	GCJ188R72A153KA01#		
				±20%	GCJ188R72A153MA01#		
			18000pF	±10%	GCJ188R72A183KA01#		
				±20%	GCJ188R72A183MA01#		
			22000pF	±10%	GCJ188R72A223KA01#		
				±20%	GCJ188R72A223MA01#		
			27000pF	±10%	GCJ188R72A273KA01#		
				±20%	GCJ188R72A273MA01#		
			33000pF	±10%	GCJ188R72A333KA01#		
				±20%	GCJ188R72A333MA01#		
			39000pF	±10%	GCJ188R72A393KA01#		
				±20%	GCJ188R72A393MA01#		
			47000pF	±10%	GCJ188R72A473KA01#		
				±20%	GCJ188R72A473MA01#		
			56000pF	±10%	GCJ188R72A563KA01#		
				±20%	GCJ188R72A563MA01#		
			68000pF	±10%	GCJ188R72A683KA01#		
				±20%	GCJ188R72A683MA01#		
			1000pF	±10%	GCJ188R71H102KA01#		
				±20%	GCJ188R71H102MA01#		
			1200pF	±10%	GCJ188R71H122KA01#		
±20%	GCJ188R71H122MA01#						
1500pF	±10%	GCJ188R71H152KA01#					
	±20%	GCJ188R71H152MA01#					
1800pF	±10%	GCJ188R71H182KA01#					
	±20%	GCJ188R71H182MA01#					
0.9mm	50Vdc	X8L	0.15μF	±10%	GCJ188L8EH154KA07#	D4	
				±20%	GCJ188L8EH224KA07#	D4	
			0.22μF	±10%	GCJ188R91H472KA01#		
				±20%	GCJ188R91H103KA01#		
			1000pF	±10%	GCJ188R91H103MA01#		
				±20%	GCJ188R91H103MA01#		
			0.10μF	±10%	GCJ188R91H104KA01#		
				±20%	GCJ188R91H104MA01#		
			0.12μF	±10%	GCJ188R91H124KA01#		
				±20%	GCJ188R91H124MA01#		
		0.15μF	±10%	GCJ188R91H154KA01#			
			±20%	GCJ188R91H154MA01#			
		0.18μF	±10%	GCJ188R91H184KA01#			
			±20%	GCJ188R91H184MA01#			
		0.22μF	±10%	GCJ188R91H224KA01#			
			±20%	GCJ188R91H224MA01#			
		X7R	1000pF	±10%	GCJ188R71H102KA01#		
				±20%	GCJ188R71H102MA01#		
				1200pF	±10%	GCJ188R71H122KA01#	
					±20%	GCJ188R71H122MA01#	
				1500pF	±10%	GCJ188R71H152KA01#	

GRT Series
 GCM Series
 GC3 Series
 GCJ Series
 GCQ Series
 GCD Series
 GCE Series
 NMF Series
 KCM Series
 KC3 Series
 KCA Series
 GCB Series
 GCG Series
 ⚠Caution / Notice

Part number # indicates the package specification code.

GCJ Series High Dielectric Constant Type Part Number List

(→ 1.6×0.8mm)

T max.	Rated Voltage	TC Code	Cap.	Tol.	Part Number	T max.	Rated Voltage	TC Code	Cap.	Tol.	Part Number				
0.9mm	50Vdc	X7R	2200pF	±10%	GCJ188R71H222KA01#	0.9mm	25Vdc	X8L	3900pF	±10%	GCJ188L81E393KA01#				
				±20%	GCJ188R71H222MA01#					±10%	GCJ188L81E393MA01#				
			2700pF	±10%	GCJ188R71H272KA01#				5600pF	±10%	GCJ188L81E563KA01#				
				±20%	GCJ188R71H272MA01#					±20%	GCJ188L81E563MA01#				
			3300pF	±10%	GCJ188R71H332KA01#				6800pF	±10%	GCJ188L81E683KA01#				
				±20%	GCJ188R71H332MA01#					±20%	GCJ188L81E683MA01#				
			3900pF	±10%	GCJ188R71H392KA01#				8200pF	±10%	GCJ188L81E823KA01#				
				±20%	GCJ188R71H392MA01#					±20%	GCJ188L81E823MA01#				
			4700pF	±10%	GCJ188R71H472KA01#				0.15μF	±10%	GCJ188L81E154KA01#				
				±20%	GCJ188R71H472MA01#					±20%	GCJ188L81E154MA01#				
			5600pF	±10%	GCJ188R71H562KA01#				0.18μF	±10%	GCJ188L81E184KA01#				
				±20%	GCJ188R71H562MA01#					±20%	GCJ188L81E184MA01#				
			6800pF	±10%	GCJ188R71H682KA01#				0.22μF	±10%	GCJ188L81E224KA01#				
				±20%	GCJ188R71H682MA01#					±20%	GCJ188L81E224MA01#				
			8200pF	±10%	GCJ188R71H822KA01#				X8R	0.33μF	±10%	GCJ188R91E334KA01#			
				±20%	GCJ188R71H822MA01#						±20%	GCJ188R91E334MA01#			
			10000pF	±10%	GCJ188R71H103KA01#				0.39μF	±10%	GCJ188R91E394KA01#				
				±20%	GCJ188R71H103MA01#					±20%	GCJ188R91E394MA01#				
			12000pF	±10%	GCJ188R71H123KA01#				0.47μF	±10%	GCJ188R91E474KA01#				
				±20%	GCJ188R71H123MA01#					±20%	GCJ188R91E474MA01#				
			15000pF	±10%	GCJ188R71H153KA01#				X7R	1000pF	±10%	GCJ188R71E102KA01#			
				±20%	GCJ188R71H153MA01#						±20%	GCJ188R71E102MA01#			
			18000pF	±10%	GCJ188R71H183KA01#					1200pF	±10%	GCJ188R71E122KA01#			
				±20%	GCJ188R71H183MA01#						±20%	GCJ188R71E122MA01#			
			22000pF	±10%	GCJ188R71H223KA01#					1500pF	±10%	GCJ188R71E152KA01#			
				±20%	GCJ188R71H223MA01#						±20%	GCJ188R71E152MA01#			
			33000pF	±10%	GCJ188R71H333KA12#					1800pF	±10%	GCJ188R71E182KA01#			
				±20%	GCJ188R71H333MA12#						±20%	GCJ188R71E182MA01#			
			39000pF	±10%	GCJ188R71H393KA12#					2200pF	±10%	GCJ188R71E222KA01#			
				±20%	GCJ188R71H393MA12#						±20%	GCJ188R71E222MA01#			
			47000pF	±10%	GCJ188R71H473KA12#					2700pF	±10%	GCJ188R71E272KA01#			
				±20%	GCJ188R71H473MA12#						±20%	GCJ188R71E272MA01#			
			56000pF	±10%	GCJ188R71H563KA12#					3300pF	±10%	GCJ188R71E332KA01#			
				±20%	GCJ188R71H563MA12#						±20%	GCJ188R71E332MA01#			
			68000pF	±10%	GCJ188R71H683KA12#					3900pF	±10%	GCJ188R71E392KA01#			
				±20%	GCJ188R71H683MA12#						±20%	GCJ188R71E392MA01#			
			82000pF	±10%	GCJ188R71H823KA12#					4700pF	±10%	GCJ188R71E472KA01#			
				±20%	GCJ188R71H823MA12#						±20%	GCJ188R71E472MA01#			
			0.10μF	±10%	GCJ188R71H104KA12#					5600pF	±10%	GCJ188R71E562KA01#			
				±20%	GCJ188R71H104MA12#						±20%	GCJ188R71E562MA01#			
			0.15μF	±10%	GCJ188R71H154KA01#					6800pF	±10%	GCJ188R71E682KA01#			
				±20%	GCJ188R71H154MA01#						±20%	GCJ188R71E682MA01#			
			0.22μF	±10%	GCJ188R71H224KA01#					8200pF	±10%	GCJ188R71E822KA01#			
				±20%	GCJ188R71H224MA01#						±20%	GCJ188R71E822MA01#			
			35Vdc	X8L	33000pF					±10%	GCJ188L8YA333KA01#	10000pF	±10%	GCJ188R71E103KA01#	
										±20%	GCJ188L8YA333MA01#		±20%	GCJ188R71E103MA01#	
					39000pF					±10%	GCJ188L8YA393KA01#		12000pF	±10%	GCJ188R71E123KA01#
										±20%	GCJ188L8YA393MA01#			±20%	GCJ188R71E123MA01#
56000pF	±10%	GCJ188L8YA563KA01#	15000pF	±10%	GCJ188R71E153KA01#										
	±20%	GCJ188L8YA563MA01#		±20%	GCJ188R71E153MA01#										
68000pF	±10%	GCJ188L8YA683KA01#	18000pF	±10%	GCJ188R71E183KA01#										
	±20%	GCJ188L8YA683MA01#		±20%	GCJ188R71E183MA01#										
25Vdc	X8L	33000pF	±10%	GCJ188L81E333KA01#	22000pF	±10%	GCJ188R71E223KA01#								
			±20%	GCJ188L81E333MA01#		±20%	GCJ188R71E223MA01#								

GRT Series
 GCM Series
 GC3 Series
 GCJ Series
 GCQ Series
 GCD Series
 GCE Series
 NMF Series
 KCM Series
 KC3 Series
 KCA Series
 GCB Series
 GCG Series
 ⚠Caution / Notice

Part number # indicates the package specification code.

GCJ Series High Dielectric Constant Type Part Number List

(→ 1.6×0.8mm)

T max.	Rated Voltage	TC Code	Cap.	Tol.	Part Number		
0.9mm	25Vdc	X7R	27000pF	±10%	GCJ188R71E273KA01#		
				±20%	GCJ188R71E273MA01#		
			33000pF	±10%	GCJ188R71E333KA01#		
				±20%	GCJ188R71E333MA01#		
			39000pF	±10%	GCJ188R71E393KA01#		
				±20%	GCJ188R71E393MA01#		
			47000pF	±10%	GCJ188R71E473KA01#		
				±20%	GCJ188R71E473MA01#		
			56000pF	±10%	GCJ188R71E563KA12#		
				±20%	GCJ188R71E563MA12#		
			68000pF	±10%	GCJ188R71E683KA12#		
				±20%	GCJ188R71E683MA12#		
			82000pF	±10%	GCJ188R71E823KA12#		
				±20%	GCJ188R71E823MA12#		
			0.10μF	±10%	GCJ188R71E104KA12#		
				±20%	GCJ188R71E104MA12#		
			0.12μF	±10%	GCJ188R71E124KA01#		
				±20%	GCJ188R71E124MA01#		
			0.15μF	±10%	GCJ188R71E154KA01#		
				±20%	GCJ188R71E154MA01#		
			0.18μF	±10%	GCJ188R71E184KA12#		
				±20%	GCJ188R71E184MA12#		
			0.22μF	±10%	GCJ188R71E224KA12#		
				±20%	GCJ188R71E224MA12#		
	1.0μF	±10%	GCJ188R71E105KA01#				
		±20%	GCJ188R71E105MA01#				
	16Vdc	X8L	0.22μF	±10%	GCJ188L81C224KA01#		
				±20%	GCJ188L81C224MA01#		
				X7R	27000pF	±10%	GCJ188R71C273KA01#
						±20%	GCJ188R71C273MA01#
		33000pF	±10%		GCJ188R71C333KA01#		
			±20%		GCJ188R71C333MA01#		
		39000pF	±10%		GCJ188R71C393KA01#		
			±20%		GCJ188R71C393MA01#		
		47000pF	±10%		GCJ188R71C473KA01#		
			±20%		GCJ188R71C473MA01#		
56000pF		±10%	GCJ188R71C563KA01#				
		±20%	GCJ188R71C563MA01#				
68000pF		±10%	GCJ188R71C683KA01#				
		±20%	GCJ188R71C683MA01#				
82000pF		±10%	GCJ188R71C823KA01#				
		±20%	GCJ188R71C823MA01#				
0.10μF		±10%	GCJ188R71C104KA01#				
		±20%	GCJ188R71C104MA01#				
0.12μF		±10%	GCJ188R71C124KA01#				
		±20%	GCJ188R71C124MA01#				
0.15μF		±10%	GCJ188R71C154KA01#				
		±20%	GCJ188R71C154MA01#				
0.18μF		±10%	GCJ188R71C184KA01#				
		±20%	GCJ188R71C184MA01#				
0.22μF	±10%	GCJ188R71C224KA01#					
	±20%	GCJ188R71C224MA01#					
0.27μF	±10%	GCJ188R71C274KA01#					
	±20%	GCJ188R71C274MA01#					

T max.	Rated Voltage	TC Code	Cap.	Tol.	Part Number	
0.9mm	16Vdc	X7R	0.33μF	±10%	GCJ188R71C334KA01#	
				±20%	GCJ188R71C334MA01#	
			0.39μF	±10%	GCJ188R71C394KA12#	
				±20%	GCJ188R71C394MA12#	
			0.47μF	±10%	GCJ188R71C474KA12#	
				±20%	GCJ188R71C474MA12#	
	10Vdc	X7R	0.22μF	±10%	GCJ188R71A224KA01#	
				±20%	GCJ188R71A224MA01#	
	6.3Vdc	X7R	2.2μF	±10%	GCJ188R70J225KE01#	
				±20%	GCJ188R70J225ME01#	
	1.0mm	6.3Vdc	X8L	3.3μF	±10%	GCJ188L8EC335KE08# D4
					±20%	GCJ188M8EC475KE08# D4
X8M			4.7μF	±10%	GCJ188M8EC475KE08# D4	
				±20%	GCJ188C70J335KE02#	
X7S		3.3μF	±10%	GCJ188C70J335KE02#		
			±20%	GCJ188C70J335ME02#		
		4.7μF	±10%	GCJ188C70J475KE02#		
			±20%	GCJ188C70J475ME02#		

2.0×1.25mm

T max.	Rated Voltage	TC Code	Cap.	Tol.	Part Number					
0.95mm	100Vdc	X7R	27000pF	±10%	GCJ219R72A273KA01#					
				±20%	GCJ219R72A273MA01#					
				33000pF	±10%	GCJ219R72A333KA01#				
					±20%	GCJ219R72A333MA01#				
			39000pF	±10%	GCJ219R72A393KA01#					
				±20%	GCJ219R72A393MA01#					
			50Vdc	X7R	0.33μF	±10%	GCJ219R71H334KA12#			
						±20%	GCJ219R71H334MA12#			
						25Vdc	X7R	0.33μF	±10%	GCJ219R71E334KA01#
									±20%	GCJ219R71E334MA01#
						0.47μF	±10%	GCJ219R71E474KA12#		
							±20%	GCJ219R71E474MA12#		
	16Vdc	X7R	0.68μF	±10%	GCJ219R71C684KA01#					
				±20%	GCJ219R71C684MA01#					
			0.82μF	±10%	GCJ219R71C824KA01#					
				±20%	GCJ219R71C824MA01#					
			1.0μF	±10%	GCJ219R71C105KA01#					
				±20%	GCJ219R71C105MA01#					
1.0mm	250Vdc	X7R	1000pF	±10%	GCJ21AR72E102KXJ1#					
				±10%	GCJ21AR72E152KXJ1#					
				±10%	GCJ21AR72E222KXJ1#					
				±10%	GCJ21AR72E332KXJ1#					
				±10%	GCJ21AR72E472KXJ1#					
				±10%	GCJ21AR72E682KXJ1#					
				1.45mm	250Vdc	X7R	10000pF	±10%	GCJ21BR72E103KXJ3#	
								±10%	GCJ21BR72E153KXJ3#	
±10%	GCJ21BR72E223KXJ3#									
100Vdc	X7R	27000pF	±10%					GCJ21BR72A273KA01#		
			±20%					GCJ21BR72A273MA01#		
33000pF	±10%	GCJ21BR72A333KA01#								
	±20%	GCJ21BR72A333MA01#								
39000pF	±10%	GCJ21BR72A393KA01#								
	±20%	GCJ21BR72A393MA01#								

Part number # indicates the package specification code.

GRT Series
 GCM Series
 GC3 Series
 GCJ Series
 GCQ Series
 GCD Series
 GCE Series
 NMF Series
 KCM Series
 KC3 Series
 KCA Series
 GCB Series
 GCG Series
 ⚠Caution /Notice

GCJ Series High Dielectric Constant Type Part Number List

(→ 2.0×1.25mm)

T max.	Rated Voltage	TC Code	Cap.	Tol.	Part Number		T max.	Rated Voltage	TC Code	Cap.	Tol.	Part Number						
1.45mm	100Vdc	X7R	47000pF	±10%	GCJ21BR72A473KA01#		1.45mm	25Vdc	X8L	0.82μF	±20%	GCJ21BL81E824MA01#						
				±20%	GCJ21BR72A473MA01#						1.0μF	±10%	GCJ21BL81E105KA01#					
			±10%	GCJ21BR72A563KA01#		±20%				GCJ21BL81E105MA01#								
			56000pF	±10%	GCJ21BR72A563MA01#					X7R	0.27μF	±10%	GCJ21BR71E274KA01#					
				±20%	GCJ21BR72A563MA01#							±20%	GCJ21BR71E274MA01#					
			68000pF	±10%	GCJ21BR72A683KA01#						0.33μF	±10%	GCJ21BR71E334KA01#					
				±20%	GCJ21BR72A683MA01#							±20%	GCJ21BR71E334MA01#					
			82000pF	±10%	GCJ21BR72A823KA01#						0.39μF	±10%	GCJ21BR71E394KA01#					
				±20%	GCJ21BR72A823MA01#							±20%	GCJ21BR71E394MA01#					
			0.10μF	±10%	GCJ21BR72A104KA01#						0.47μF	±10%	GCJ21BR71E474KA01#					
				±20%	GCJ21BR72A104MA01#							±20%	GCJ21BR71E474MA01#					
			50Vdc	X8L	82000pF	±10%					GCJ21BL81H823KA01#		16Vdc	X8L	0.56μF	±10%	GCJ21BL81C564KA01#	
						±20%					GCJ21BL81H823MA01#					±20%	GCJ21BL81C564MA01#	
					0.10μF	±10%					GCJ21BL81H104KA01#				0.68μF	±10%	GCJ21BL81C684KA01#	
						±20%					GCJ21BL81H104MA01#					±20%	GCJ21BL81C684MA01#	
					0.47μF	±10%					GCJ21BL8EH474KA07#	D4			0.82μF	±10%	GCJ21BL81C824KA01#	
						±20%					GCJ21BL8EH474MA07#					±20%	GCJ21BL81C824MA01#	
				X7R	0.22μF	±10%					GCJ21BR71H224KA01#				1.0μF	±10%	GCJ21BR71E105KA12#	
	±20%	GCJ21BR71H224MA01#						±20%	GCJ21BR71E105MA12#									
	0.33μF	±10%			GCJ21BR71H334KA12#			1.5μF	±10%		GCJ21BR71E155KA01#							
		±20%			GCJ21BR71H334MA12#				±20%		GCJ21BR71E155MA01#							
	0.47μF	±10%			GCJ21BR71H474KA12#			2.2μF	±10%	GCJ21BR71E225KA01#								
		±20%			GCJ21BR71H474MA12#				±20%	GCJ21BR71E225MA01#								
	1.0μF	±10%			GCJ21BR71H105KA01#			X7R	0.27μF	±10%	GCJ21BR71C274KA01#							
		±20%			GCJ21BR71H105MA01#					±20%	GCJ21BR71C274MA01#							
	35Vdc	X8L			0.12μF	±10%			GCJ21BL8YA124KA01#		0.33μF	±10%			GCJ21BR71C334KA01#			
						±20%			GCJ21BL8YA124MA01#			±20%			GCJ21BR71C334MA01#			
					0.15μF	±10%			GCJ21BL8YA154KA01#		0.39μF	±10%			GCJ21BR71C394KA01#			
						±20%			GCJ21BL8YA154MA01#			±20%			GCJ21BR71C394MA01#			
			0.18μF	±10%	GCJ21BL8YA184KA01#				0.47μF	±10%	GCJ21BR71C474KA01#							
				±20%	GCJ21BL8YA184MA01#					±20%	GCJ21BR71C474MA01#							
	0.22μF	±10%	GCJ21BL8YA224KA01#		0.56μF	±10%			GCJ21BR71C564KA01#									
		±20%	GCJ21BL8YA224MA01#			±20%			GCJ21BR71C564MA01#									
	25Vdc	X8L	0.12μF	±10%	GCJ21BL81E124KA01#				0.68μF	±10%	GCJ21BR71C684KA01#							
				±20%	GCJ21BL81E124MA01#					±20%	GCJ21BR71C684MA01#							
			0.15μF	±10%	GCJ21BL81E154KA01#			0.82μF	±10%	GCJ21BR71C824KA01#								
±20%				GCJ21BL81E154MA01#		±20%	GCJ21BR71C824MA01#											
0.18μF			±10%	GCJ21BL81E184KA01#		1.0μF	±10%	GCJ21BL81C105KA01#										
			±20%	GCJ21BL81E184MA01#			±20%	GCJ21BL81C105MA01#										
0.22μF			±10%	GCJ21BL81E224KA01#		0.27μF	±10%	GCJ21BR71C274KA01#										
			±20%	GCJ21BL81E224MA01#			±20%	GCJ21BR71C274MA01#										
0.27μF			±10%	GCJ21BL81E274KA01#		0.33μF	±10%	GCJ21BR71C334KA01#										
			±20%	GCJ21BL81E274MA01#			±20%	GCJ21BR71C334MA01#										
0.33μF			±10%	GCJ21BL81E334KA01#		0.39μF	±10%	GCJ21BR71C394KA01#										
			±20%	GCJ21BL81E334MA01#			±20%	GCJ21BR71C394MA01#										
0.39μF			±10%	GCJ21BL81E394KA01#		0.47μF	±10%	GCJ21BR71C474KA01#										
			±20%	GCJ21BL81E394MA01#			±20%	GCJ21BR71C474MA01#										
0.47μF			±10%	GCJ21BL81E474KA01#		0.56μF	±10%	GCJ21BR71C564KA01#										
			±20%	GCJ21BL81E474MA01#			±20%	GCJ21BR71C564MA01#										
0.68μF			±10%	GCJ21BL81E684KA01#		0.68μF	±10%	GCJ21BR71C684KA01#										
			±20%	GCJ21BL81E684MA01#			±20%	GCJ21BR71C684MA01#										
0.82μF	±10%	GCJ21BL81E824KA01#		0.82μF	±10%	GCJ21BR71C824KA01#												
	±20%	GCJ21BL81E824MA01#			±20%	GCJ21BR71C824MA01#												
							10Vdc	X7R	2.2μF	±10%	GCJ21BR71A225KA01#							

Part number # indicates the package specification code.

GRT Series
 GCM Series
 GC3 Series
 GCJ Series
 GCQ Series
 GCD Series
 GCE Series
 NMF Series
 KCM Series
 KC3 Series
 KCA Series
 GCB Series
 GCG Series
 ⚠Caution / Notice

GCJ Series High Dielectric Constant Type Part Number List

(→ 2.0×1.25mm)

T max.	Rated Voltage	TC Code	Cap.	Tol.	Part Number
1.45mm	10Vdc	X7R	2.2μF	±20%	GCJ21BR71A225MA01#
			10μF	±10%	GCJ21BR71A106KE01#
				±20%	GCJ21BR71A106ME01#
1.5mm	100Vdc	X7S	1.0μF	±10%	GCJ21BC72A105KE02#
				±20%	GCJ21BC72A105ME02#

3.2×1.6mm

T max.	Rated Voltage	TC Code	Cap.	Tol.	Part Number		
1.25mm	1000Vdc	X7R	1000pF	±10%	GCJ31BR73A102KXJ1#		
			1500pF	±10%	GCJ31BR73A152KXJ1#		
			2200pF	±10%	GCJ31BR73A222KXJ1#		
			3300pF	±10%	GCJ31BR73A332KXJ1#		
			4700pF	±10%	GCJ31BR73A472KXJ1#		
	630Vdc	X7R	1000pF	±10%	GCJ31BR72J102KXJ1#		
			1500pF	±10%	GCJ31BR72J152KXJ1#		
			2200pF	±10%	GCJ31BR72J222KXJ1#		
			3300pF	±10%	GCJ31BR72J332KXJ1#		
			4700pF	±10%	GCJ31BR72J472KXJ1#		
			6800pF	±10%	GCJ31BR72J682KXJ1#		
			10000pF	±10%	GCJ31BR72J103KXJ1#		
			250Vdc	X7R	15000pF	±10%	GCJ31BR72E153KXJ1#
	22000pF	±10%			GCJ31BR72E223KXJ1#		
	68000pF	±10%			GCJ31BR72E683KXJ1#		
	100Vdc	X7R			0.15μF	±10%	GCJ31MR72A154KA01#
					±20%	GCJ31MR72A154MA01#	
			0.18μF	±10%	GCJ31MR72A184KA01#		
±20%				GCJ31MR72A184MA01#			
0.22μF			±10%	GCJ31MR72A224KA01#			
		±20%	GCJ31MR72A224MA01#				
		50Vdc	X7R	0.47μF	±10%	GCJ31MR71H474KA01#	
±20%				GCJ31MR71H474MA01#			
0.56μF				±10%	GCJ31MR71H564KA12#		
				±20%	GCJ31MR71H564MA12#		
0.68μF	±10%			GCJ31MR71H684KA12#			
	±20%	GCJ31MR71H684MA12#					
0.82μF	±10%	GCJ31MR71H824KA12#					
	±20%	GCJ31MR71H824MA12#					
1.0μF	±10%	GCJ31MR71H105KA12#					
	±20%	GCJ31MR71H105MA12#					
35Vdc	X8L	0.47μF	±10%	GCJ31ML8YA474KA01#			
		±20%	GCJ31ML8YA474MA01#				
25Vdc	X7R	2.2μF	±10%	GCJ31MR71E225KA12#			
			±20%	GCJ31MR71E225MA12#			
		3.3μF	±10%	GCJ31MR71E335KA12#			
±20%	GCJ31MR71E335MA12#						
16Vdc	X8L	1.5μF	±10%	GCJ31ML81C155KA01#			
			±20%	GCJ31ML81C155MA01#			
		2.2μF	±10%	GCJ31ML81C225KA01#			
			±20%	GCJ31ML81C225MA01#			
	X7R	2.2μF	±10%	GCJ31MR71C225KA01#			
			±20%	GCJ31MR71C225MA01#			
1.8mm	1000Vdc	X7R	6800pF	±10%	GCJ31CR73A682KXJ3#		

T max.	Rated Voltage	TC Code	Cap.	Tol.	Part Number		
1.8mm	1000Vdc	X7R	10000pF	±10%	GCJ31CR73A103KXJ3#		
			630Vdc	X7R	15000pF	±10%	GCJ31CR72J153KXJ3#
	22000pF	±10%			GCJ31CR72J223KXJ3#		
	250Vdc	X7R			33000pF	±10%	GCJ31CR72E333KXJ3#
					47000pF	±10%	GCJ31CR72E473KXJ3#
	0.10μF	±10%	GCJ31CR72E104KXJ3#				
1.9mm		100Vdc	X8L	1.0μF	±10%	GCJ31CL8EL105KA07#	
	±20%			GCJ31CL8EL105MA07#			
	X7R		1.0μF	±10%	GCJ31CR72A105KA01#		
		±20%	GCJ31CR72A105MA01#				
	X7S	2.2μF	±10%	GCJ31CC72A225KE01#			
			±20%	GCJ31CC72A225ME01#			
	50Vdc	X7R	0.56μF	±10%	GCJ31CR71H564KA01#		
				±20%	GCJ31CR71H564MA01#		
			0.68μF	±10%	GCJ31CR71H684KA01#		
				±20%	GCJ31CR71H684MA01#		
0.82μF			±10%	GCJ31CR71H824KA12#			
			±20%	GCJ31CR71H824MA12#			
1.0μF			±10%	GCJ31CR71H105KA12#			
			±20%	GCJ31CR71H105MA12#			
1.5μF			±10%	GCJ31CR71H155KA12#			
			±20%	GCJ31CR71H155MA12#			
2.2μF	±10%	GCJ31CR71H225KA12#					
	±20%	GCJ31CR71H225MA12#					
X7S	4.7μF	±10%	GCJ31CC71H475KA01#				
		±20%	GCJ31CC71H475MA01#				
35Vdc	X8L	0.56μF	±10%	GCJ31CL8YA564KA01#			
			±20%	GCJ31CL8YA564MA01#			
		0.68μF	±10%	GCJ31CL8YA684KA01#			
			±20%	GCJ31CL8YA684MA01#			
		0.82μF	±10%	GCJ31CL8YA824KA01#			
			±20%	GCJ31CL8YA824MA01#			
		1.0μF	±10%	GCJ31CL8YA105KA01#			
			±20%	GCJ31CL8YA105MA01#			
		25Vdc	X7R	4.7μF	±10%	GCJ31CR71E475KA12#	
					±20%	GCJ31CR71E475MA12#	
16Vdc	X8L	3.3μF	±10%	GCJ31CL81C335KA01#			
			±20%	GCJ31CL81C335MA01#			
		4.7μF	±10%	GCJ31CL81C475KA01#			
			±20%	GCJ31CL81C475MA01#			
	X7R	3.3μF	±10%	GCJ31CR71C335KA01#			
			±20%	GCJ31CR71C335MA01#			
		4.7μF	±10%	GCJ31CR71C475KA01#			
			±20%	GCJ31CR71C475MA01#			
10Vdc	X8L	22μF	±10%	GCJ31CL8ED226KE07#			
			±20%	GCJ31CL8ED226ME07#			
6.3Vdc	X7R	6.8μF	±10%	GCJ31CR71A685KA13#			
			±20%	GCJ31CR71A685MA13#			
		10μF	±10%	GCJ31CR71A106KA13#			
			±20%	GCJ31CR71A106MA13#			
		22μF	±10%	GCJ31CR71A226KE01#			
			±20%	GCJ31CR71A226ME01#			
2.0mm	35Vdc	X7T	10μF	±10%	GCJ31CD7YA106KE02#		
				±20%	GCJ31CD7YA106ME02#		

Part number # indicates the package specification code.

GRT Series
 GCM Series
 GC3 Series
 GCJ Series
 GCQ Series
 GCD Series
 GCE Series
 NMF Series
 KCM Series
 KC3 Series
 KCA Series
 GCB Series
 GCG Series
 ⚠Caution / Notice

GCJ Series High Dielectric Constant Type Part Number List

(→ 3.2×1.6mm)

T max.	Rated Voltage	TC Code	Cap.	Tol.	Part Number	
2.0mm	25Vdc	X8L	10µF	±10%	GCJ31CL8EF106KA08#	D4
		X7S	10µF	±10%	GCJ31CC71E106KA15#	
					±20%	

T max.	Rated Voltage	TC Code	Cap.	Tol.	Part Number	
2.0mm	630Vdc	X7R	0.10µF	±10%	GCJ43DR72J104KXJ1#	
			0.22µF	±10%	GCJ43DR72E224KXJ1#	
	250Vdc	X7R	0.33µF	±10%	GCJ43DR72E334KXJ1#	
			0.47µF	±10%	GCJ43DR72E474KXJ1#	

3.2×2.5mm

T max.	Rated Voltage	TC Code	Cap.	Tol.	Part Number		
1.5mm	630Vdc	X7R	6800pF	±10%	GCJ32QR72J682KXJ1#		
			10000pF	±10%	GCJ32QR72J103KXJ1#		
	250Vdc	X7R	68000pF	±10%	GCJ32QR72E683KXJ1#		
			0.15µF	±10%	GCJ32QR72E154KXJ1#		
2.0mm	1000Vdc	X7R	15000pF	±10%	GCJ32DR73A153KXJ1#		
			22000pF	±10%	GCJ32DR73A223KXJ1#		
	630Vdc	X7R	15000pF	±10%	GCJ32DR72J153KXJ1#		
			22000pF	±10%	GCJ32DR72J223KXJ1#		
			33000pF	±10%	GCJ32DR72J333KXJ1#		
			47000pF	±10%	GCJ32DR72J473KXJ1#		
	250Vdc	X7R	0.10µF	±10%	GCJ32DR72E104KXJ1#		
			0.22µF	±10%	GCJ32DR72E224KXJ1#		
	2.3mm	100Vdc	X8L	2.2µF	±10%	GCJ32DL8EL225KA07#	D4
				X7R	2.2µF	±10%	
				±20%	GCJ32DR72A225MA01#		
X7S			4.7µF	±10%	GCJ32DC72A475KE01#		
				±20%	GCJ32DC72A475ME01#		
2.8mm			50Vdc	X7R	4.7µF	±10%	
		±20%			GCJ32ER71H475MA12#		
	X7S	10µF		±10%	GCJ32EC71H106KA01#		
				±20%	GCJ32EC71H106MA01#		
	25Vdc	X8L		4.7µF	±10%	GCJ32EL81E475KA01#	
					±20%	GCJ32EL81E475MA01#	
		X7R	10µF	±10%	GCJ32ER71E106KA18#		
				±20%	GCJ32ER71E106MA18#		
	16Vdc	X8R	6.8µF	±10%	GCJ32ER91C685KE01#		
				±20%	GCJ32ER91C685ME01#		
			10µF	±10%	GCJ32ER91C106KE01#		
			±20%	GCJ32ER91C106ME01#			
X7R		22µF	±10%	GCJ32ER71C226KE01#			
			±20%	GCJ32ER71C226ME01#			
6.3Vdc	X7R	47µF	±10%	GCJ32ER70J476KE01#			
			±20%	GCJ32ER70J476ME01#			
2.85mm	25Vdc	X8L	22µF	±10%	GCJ32EL8EF226KE08#	D4	
		X7S	22µF	±10%	GCJ32EC71E226KE02#		

5.7×5.0mm

T max.	Rated Voltage	TC Code	Cap.	Tol.	Part Number	
2.0mm	1000Vdc	X7R	68000pF	±10%	GCJ55DR73A683KXJ1#	
			0.10µF	±10%	GCJ55DR73A104KXJ1#	
	630Vdc	X7R	0.10µF	±10%	GCJ55DR72J104KXJ1#	
			0.15µF	±10%	GCJ55DR72J154KXJ1#	
			0.22µF	±10%	GCJ55DR72J224KXJ1#	
			0.33µF	±10%	GCJ55DR72E334KXJ1#	
	250Vdc	X7R	0.47µF	±10%	GCJ55DR72E474KXJ1#	
			0.68µF	±10%	GCJ55DR72E684KXJ1#	
			1.0µF	±10%	GCJ55DR72E105KXJ1#	

4.5×3.2mm

T max.	Rated Voltage	TC Code	Cap.	Tol.	Part Number	
1.5mm	630Vdc	X7R	68000pF	±10%	GCJ43QR72J683KXJ1#	
	250Vdc	X7R	0.15µF	±10%	GCJ43QR72E154KXJ1#	
2.0mm	1000Vdc	X7R	33000pF	±10%	GCJ43DR73A333KXJ1#	
			47000pF	±10%	GCJ43DR73A473KXJ1#	
	630Vdc	X7R	33000pF	±10%	GCJ43DR72J333KXJ1#	
			47000pF	±10%	GCJ43DR72J473KXJ1#	

Part number # indicates the package specification code.

High Q Chip Multilayer Ceramic Capacitors for Automotive

GCQ Series



This product improves the high frequency characteristics and contributes to a reduction of power consumption by the High Q and low ESR. Capacitor for automotive applications such as power train and safety equipment.

Features

① High Q and Low ESR were achieved at a "high frequency," which is ideal for matching applications.

High Q and Low ESR were achieved at a high frequency, by adopting a ceramic material with extremely low loss at a high frequency as the dielectric material, and copper for the internal electrodes. This product is ideal for matching applications.



<Example of Structure>

② This is a High Q capacitor for V2X, ADAS, and automotive communication applications which conform to AEC-Q200.

The self-resonant frequency of 5.9 GHz (for 2.2 pF products) is ideal for the DC-CUT in DSRC IEEE821.11p.

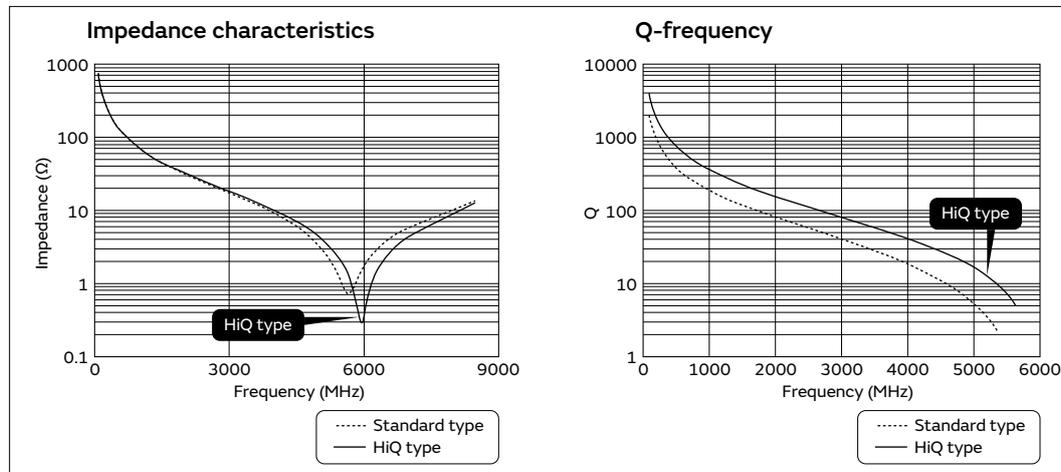

③ Can be used for tight tolerance.

In addition to standard tolerance, the allowable range of this product is also suitable for the following tight tolerance.

Capacitance Range	Standard Capacitance Tolerance (Capacitance Tolerance Symbol)	Narrow Capacitance Tolerance (Capacitance Tolerance Symbol)
to 0.9pF	±0.1pF (B)	±0.05pF (W)
1 to 5pF	±0.25pF (C)	±0.05pF (W), ±0.1pF (B)
5.1 to 9.9pF	±0.5pF (D)	±0.05pF (W), ±0.1pF (B), ±0.25pF (C)
10pF~	±5% (J)	±2% (G)

GRT Series
 GCM Series
 GC3 Series
 GCJ Series
 GCQ Series
 GCD Series
 GCE Series
 NMF Series
 KCM Series
 KC3 Series
 KCA Series
 GCB Series
 GCG Series
 △Caution /Notice

Specifications

Size	1.0×0.5mm
Rated Voltage	50Vdc
Capacitance	0.10pF to 47μF
Main Applications	DC cut in the 5.9GHz of V2X applications, and RF matching RF matching in the other automotive communication applications

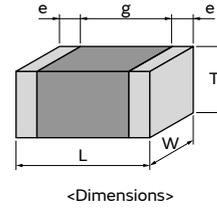

GRT Series

GCM Series

GC3 Series

GCJ Series

GCQ Series

GCD Series

GCE Series

NMF Series

KCM Series

KC3 Series

KCA Series

GCB Series

GCG Series

⚠Caution /Notice

GCQ Series Temperature Compensating Type Part Number List

1.0x0.5mm

T max.	Rated Voltage	TC Code	Cap.	Tol.	Part Number
0.55mm	50Vdc	COG	0.10pF	±0.05pF	GCQ1555C1HR10WB01#
				±0.1pF	GCQ1555C1HR10BB01#
			0.11pF	±0.05pF	GCQ1555C1HR11WB01#
				±0.1pF	GCQ1555C1HR11BB01#
			0.12pF	±0.05pF	GCQ1555C1HR12WB01#
				±0.1pF	GCQ1555C1HR12BB01#
			0.13pF	±0.05pF	GCQ1555C1HR13WB01#
				±0.1pF	GCQ1555C1HR13BB01#
			0.15pF	±0.05pF	GCQ1555C1HR15WB01#
				±0.1pF	GCQ1555C1HR15BB01#
			0.16pF	±0.05pF	GCQ1555C1HR16WB01#
				±0.1pF	GCQ1555C1HR16BB01#
			0.18pF	±0.05pF	GCQ1555C1HR18WB01#
				±0.1pF	GCQ1555C1HR18BB01#
			0.20pF	±0.05pF	GCQ1555C1HR20WB01#
				±0.1pF	GCQ1555C1HR20BB01#
			0.22pF	±0.05pF	GCQ1555C1HR22WB01#
				±0.1pF	GCQ1555C1HR22BB01#
			0.24pF	±0.05pF	GCQ1555C1HR24WB01#
				±0.1pF	GCQ1555C1HR24BB01#
			0.25pF	±0.1pF	GCQ1555C1HR25BB01#
			0.27pF	±0.05pF	GCQ1555C1HR27WB01#
				±0.1pF	GCQ1555C1HR27BB01#
				±0.25pF	GCQ1555C1HR27CB01#
			0.30pF	±0.05pF	GCQ1555C1HR30WB01#
				±0.1pF	GCQ1555C1HR30BB01#
				±0.25pF	GCQ1555C1HR30CB01#
			0.33pF	±0.05pF	GCQ1555C1HR33WB01#
				±0.1pF	GCQ1555C1HR33BB01#
				±0.25pF	GCQ1555C1HR33CB01#
			0.36pF	±0.05pF	GCQ1555C1HR36WB01#
				±0.1pF	GCQ1555C1HR36BB01#
				±0.25pF	GCQ1555C1HR36CB01#
			0.39pF	±0.05pF	GCQ1555C1HR39WB01#
				±0.1pF	GCQ1555C1HR39BB01#
				±0.25pF	GCQ1555C1HR39CB01#
			0.40pF	±0.05pF	GCQ1555C1HR40WB01#
				±0.1pF	GCQ1555C1HR40BB01#
				±0.25pF	GCQ1555C1HR40CB01#
			0.43pF	±0.05pF	GCQ1555C1HR43WB01#
				±0.1pF	GCQ1555C1HR43BB01#
				±0.25pF	GCQ1555C1HR43CB01#
			0.45pF	±0.05pF	GCQ1555C1HR45WB01#
			0.47pF	±0.05pF	GCQ1555C1HR47WB01#
				±0.1pF	GCQ1555C1HR47BB01#
				±0.25pF	GCQ1555C1HR47CB01#
			0.50pF	±0.05pF	GCQ1555C1HR50WB01#
				±0.1pF	GCQ1555C1HR50BB01#
±0.25pF	GCQ1555C1HR50CB01#				
±0.5pF	GCQ1555C1HR50DB01#				
0.51pF	±0.05pF	GCQ1555C1HR51WB01#			
	±0.1pF	GCQ1555C1HR51BB01#			

T max.	Rated Voltage	TC Code	Cap.	Tol.	Part Number
0.55mm	50Vdc	COG	0.51pF	±0.25pF	GCQ1555C1HR51CB01#
				±0.5pF	GCQ1555C1HR51DB01#
			0.56pF	±0.05pF	GCQ1555C1HR56WB01#
				±0.1pF	GCQ1555C1HR56BB01#
				±0.25pF	GCQ1555C1HR56CB01#
				±0.5pF	GCQ1555C1HR56DB01#
			0.60pF	±0.05pF	GCQ1555C1HR60WB01#
				±0.1pF	GCQ1555C1HR60BB01#
				±0.25pF	GCQ1555C1HR60CB01#
				±0.5pF	GCQ1555C1HR60DB01#
			0.62pF	±0.05pF	GCQ1555C1HR62WB01#
				±0.1pF	GCQ1555C1HR62BB01#
				±0.25pF	GCQ1555C1HR62CB01#
				±0.5pF	GCQ1555C1HR62DB01#
			0.68pF	±0.05pF	GCQ1555C1HR68WB01#
				±0.1pF	GCQ1555C1HR68BB01#
				±0.25pF	GCQ1555C1HR68CB01#
				±0.5pF	GCQ1555C1HR68DB01#
			0.70pF	±0.05pF	GCQ1555C1HR70WB01#
				±0.1pF	GCQ1555C1HR70BB01#
				±0.25pF	GCQ1555C1HR70CB01#
				±0.5pF	GCQ1555C1HR70DB01#
			0.75pF	±0.05pF	GCQ1555C1HR75WB01#
				±0.1pF	GCQ1555C1HR75BB01#
				±0.25pF	GCQ1555C1HR75CB01#
				±0.5pF	GCQ1555C1HR75DB01#
			0.80pF	±0.05pF	GCQ1555C1HR80WB01#
				±0.1pF	GCQ1555C1HR80BB01#
				±0.25pF	GCQ1555C1HR80CB01#
				±0.5pF	GCQ1555C1HR80DB01#
			0.82pF	±0.05pF	GCQ1555C1HR82WB01#
				±0.1pF	GCQ1555C1HR82BB01#
				±0.25pF	GCQ1555C1HR82CB01#
				±0.5pF	GCQ1555C1HR82DB01#
			0.85pF	±0.05pF	GCQ1555C1HR85WB01#
			0.90pF	±0.05pF	GCQ1555C1HR90WB01#
				±0.1pF	GCQ1555C1HR90BB01#
				±0.25pF	GCQ1555C1HR90CB01#
				±0.5pF	GCQ1555C1HR90DB01#
			0.91pF	±0.05pF	GCQ1555C1HR91WB01#
				±0.1pF	GCQ1555C1HR91BB01#
				±0.25pF	GCQ1555C1HR91CB01#
				±0.5pF	GCQ1555C1HR91DB01#
			0.95pF	±0.05pF	GCQ1555C1HR95WB01#
			1.0pF	±0.05pF	GCQ1555C1H1R0WB01#
				±0.1pF	GCQ1555C1H1R0BB01#
				±0.25pF	GCQ1555C1H1R0CB01#
				±0.5pF	GCQ1555C1H1R0DB01#
1.1pF	±0.05pF	GCQ1555C1H1R1WB01#			
	±0.1pF	GCQ1555C1H1R1BB01#			
	±0.25pF	GCQ1555C1H1R1CB01#			
	±0.5pF	GCQ1555C1H1R1DB01#			
1.2pF	±0.05pF	GCQ1555C1H1R2WB01#			
	±0.1pF	GCQ1555C1H1R2BB01#			

GRT Series
 GCM Series
 GC3 Series
 GCJ Series
 GCQ Series
 GCD Series
 GCE Series
 NMF Series
 KCM Series
 KC3 Series
 KCA Series
 GCB Series
 GCG Series
 ⚠Caution /Notice

Part number # indicates the package specification code.

GCQ Series Temperature Compensating Type Part Number List

(→ 1.0×0.5mm)

T max.	Rated Voltage	TC Code	Cap.	Tol.	Part Number	T max.	Rated Voltage	TC Code	Cap.	Tol.	Part Number
0.55mm	50Vdc	COG	1.2pF	±0.25pF	GCQ1555C1H1R2CB01#	0.55mm	50Vdc	COG	2.6pF	±0.05pF	GCQ1555C1H2R6WB01#
				±0.5pF	GCQ1555C1H1R2DB01#					±0.1pF	GCQ1555C1H2R6BB01#
			1.3pF	±0.05pF	GCQ1555C1H1R3WB01#	±0.25pF			GCQ1555C1H2R6CB01#		
				±0.1pF	GCQ1555C1H1R3BB01#	±0.5pF			GCQ1555C1H2R6DB01#		
				±0.25pF	GCQ1555C1H1R3CB01#	2.7pF			±0.05pF	GCQ1555C1H2R7WB01#	
				±0.5pF	GCQ1555C1H1R3DB01#				±0.1pF	GCQ1555C1H2R7BB01#	
			1.4pF	±0.05pF	GCQ1555C1H1R4WB01#				±0.25pF	GCQ1555C1H2R7CB01#	
				±0.1pF	GCQ1555C1H1R4BB01#	±0.5pF			GCQ1555C1H2R7DB01#		
				±0.25pF	GCQ1555C1H1R4CB01#	2.8pF			±0.05pF	GCQ1555C1H2R8WB01#	
			±0.5pF	GCQ1555C1H1R4DB01#	±0.1pF				GCQ1555C1H2R8BB01#		
			1.5pF	±0.05pF	GCQ1555C1H1R5WB01#				±0.25pF	GCQ1555C1H2R8CB01#	
				±0.1pF	GCQ1555C1H1R5BB01#	±0.5pF			GCQ1555C1H2R8DB01#		
				±0.25pF	GCQ1555C1H1R5CB01#	2.9pF			±0.05pF	GCQ1555C1H2R9WB01#	
				±0.5pF	GCQ1555C1H1R5DB01#				±0.1pF	GCQ1555C1H2R9BB01#	
			1.6pF	±0.05pF	GCQ1555C1H1R6WB01#				±0.25pF	GCQ1555C1H2R9CB01#	
				±0.1pF	GCQ1555C1H1R6BB01#	±0.5pF			GCQ1555C1H2R9DB01#		
				±0.25pF	GCQ1555C1H1R6CB01#	3.0pF			±0.05pF	GCQ1555C1H3ROWB01#	
				±0.5pF	GCQ1555C1H1R6DB01#				±0.1pF	GCQ1555C1H3ROBB01#	
			1.7pF	±0.05pF	GCQ1555C1H1R7WB01#				±0.25pF	GCQ1555C1H3ROCB01#	
				±0.1pF	GCQ1555C1H1R7BB01#	±0.5pF			GCQ1555C1H3RODB01#		
				±0.25pF	GCQ1555C1H1R7CB01#	3.1pF			±0.05pF	GCQ1555C1H3R1WB01#	
				±0.5pF	GCQ1555C1H1R7DB01#				±0.1pF	GCQ1555C1H3R1BB01#	
			1.8pF	±0.05pF	GCQ1555C1H1R8WB01#				±0.25pF	GCQ1555C1H3R1CB01#	
				±0.1pF	GCQ1555C1H1R8BB01#	±0.5pF			GCQ1555C1H3R1DB01#		
				±0.25pF	GCQ1555C1H1R8CB01#	3.2pF			±0.05pF	GCQ1555C1H3R2WB01#	
				±0.5pF	GCQ1555C1H1R8DB01#				±0.1pF	GCQ1555C1H3R2BB01#	
			1.9pF	±0.05pF	GCQ1555C1H1R9WB01#				±0.25pF	GCQ1555C1H3R2CB01#	
				±0.1pF	GCQ1555C1H1R9BB01#	±0.5pF			GCQ1555C1H3R2DB01#		
				±0.25pF	GCQ1555C1H1R9CB01#	3.3pF			±0.05pF	GCQ1555C1H3R3WB01#	
				±0.5pF	GCQ1555C1H1R9DB01#				±0.1pF	GCQ1555C1H3R3BB01#	
			2.0pF	±0.05pF	GCQ1555C1H2R0WB01#				±0.25pF	GCQ1555C1H3R3CB01#	
				±0.1pF	GCQ1555C1H2R0BB01#	±0.5pF			GCQ1555C1H3R3DB01#		
				±0.25pF	GCQ1555C1H2R0CB01#	3.4pF			±0.05pF	GCQ1555C1H3R4WB01#	
				±0.5pF	GCQ1555C1H2R0DB01#				±0.1pF	GCQ1555C1H3R4BB01#	
			2.1pF	±0.05pF	GCQ1555C1H2R1WB01#				±0.25pF	GCQ1555C1H3R4CB01#	
				±0.1pF	GCQ1555C1H2R1BB01#	±0.5pF			GCQ1555C1H3R4DB01#		
				±0.25pF	GCQ1555C1H2R1CB01#	3.5pF			±0.05pF	GCQ1555C1H3R5WB01#	
				±0.5pF	GCQ1555C1H2R1DB01#				±0.1pF	GCQ1555C1H3R5BB01#	
			2.2pF	±0.05pF	GCQ1555C1H2R2WB01#				±0.25pF	GCQ1555C1H3R5CB01#	
				±0.1pF	GCQ1555C1H2R2BB01#	±0.5pF			GCQ1555C1H3R5DB01#		
				±0.25pF	GCQ1555C1H2R2CB01#	3.6pF			±0.05pF	GCQ1555C1H3R6WB01#	
				±0.5pF	GCQ1555C1H2R2DB01#				±0.1pF	GCQ1555C1H3R6BB01#	
			2.3pF	±0.05pF	GCQ1555C1H2R3WB01#				±0.25pF	GCQ1555C1H3R6CB01#	
				±0.1pF	GCQ1555C1H2R3BB01#	±0.5pF			GCQ1555C1H3R6DB01#		
				±0.25pF	GCQ1555C1H2R3CB01#	3.7pF			±0.05pF	GCQ1555C1H3R7WB01#	
				±0.5pF	GCQ1555C1H2R3DB01#				±0.1pF	GCQ1555C1H3R7BB01#	
			2.4pF	±0.05pF	GCQ1555C1H2R4WB01#				±0.25pF	GCQ1555C1H3R7CB01#	
				±0.1pF	GCQ1555C1H2R4BB01#	±0.5pF			GCQ1555C1H3R7DB01#		
				±0.25pF	GCQ1555C1H2R4CB01#	3.8pF			±0.05pF	GCQ1555C1H3R8WB01#	
				±0.5pF	GCQ1555C1H2R4DB01#				±0.1pF	GCQ1555C1H3R8BB01#	
			2.5pF	±0.05pF	GCQ1555C1H2R5WB01#				±0.25pF	GCQ1555C1H3R8CB01#	
				±0.1pF	GCQ1555C1H2R5BB01#	±0.5pF			GCQ1555C1H3R8DB01#		
				±0.25pF	GCQ1555C1H2R5CB01#	3.9pF			±0.05pF	GCQ1555C1H3R9WB01#	
				±0.5pF	GCQ1555C1H2R5DB01#				±0.1pF	GCQ1555C1H3R9BB01#	

Part number # indicates the package specification code.

GRT Series
 GCM Series
 GC3 Series
 GCJ Series
 GCQ Series
 GCD Series
 GCE Series
 NMF Series
 KCM Series
 KC3 Series
 KCA Series
 GCB Series
 GCG Series
 ⚠Caution /Notice

GCQ Series Temperature Compensating Type Part Number List

(→ 1.0×0.5mm)

T max.	Rated Voltage	TC Code	Cap.	Tol.	Part Number	T max.	Rated Voltage	TC Code	Cap.	Tol.	Part Number
0.55mm	50Vdc	COG	3.9pF	±0.25pF	GCQ1555C1H3R9CB01#	0.55mm	50Vdc	COG	5.3pF	±0.05pF	GCQ1555C1H5R3WB01#
				±0.5pF	GCQ1555C1H3R9DB01#					±0.1pF	GCQ1555C1H5R3BB01#
			4.0pF	±0.05pF	GCQ1555C1H4R0WB01#	±0.25pF			GCQ1555C1H5R3CB01#		
				±0.1pF	GCQ1555C1H4R0BB01#	±0.5pF			GCQ1555C1H5R3DB01#		
				±0.25pF	GCQ1555C1H4R0CB01#	5.4pF			±0.05pF	GCQ1555C1H5R4WB01#	
				±0.5pF	GCQ1555C1H4R0DB01#				±0.1pF	GCQ1555C1H5R4BB01#	
			4.1pF	±0.05pF	GCQ1555C1H4R1WB01#				±0.25pF	GCQ1555C1H5R4CB01#	
				±0.1pF	GCQ1555C1H4R1BB01#	±0.5pF			GCQ1555C1H5R4DB01#		
				±0.25pF	GCQ1555C1H4R1CB01#	5.5pF			±0.05pF	GCQ1555C1H5R5WB01#	
			±0.5pF	GCQ1555C1H4R1DB01#	±0.1pF				GCQ1555C1H5R5BB01#		
			4.2pF	±0.05pF	GCQ1555C1H4R2WB01#				±0.25pF	GCQ1555C1H5R5CB01#	
				±0.1pF	GCQ1555C1H4R2BB01#	±0.5pF			GCQ1555C1H5R5DB01#		
				±0.25pF	GCQ1555C1H4R2CB01#	5.6pF			±0.05pF	GCQ1555C1H5R6WB01#	
			±0.5pF	GCQ1555C1H4R2DB01#	±0.1pF				GCQ1555C1H5R6BB01#		
			4.3pF	±0.05pF	GCQ1555C1H4R3WB01#				±0.25pF	GCQ1555C1H5R6CB01#	
				±0.1pF	GCQ1555C1H4R3BB01#	±0.5pF			GCQ1555C1H5R6DB01#		
				±0.25pF	GCQ1555C1H4R3CB01#	5.7pF			±0.05pF	GCQ1555C1H5R7WB01#	
				±0.5pF	GCQ1555C1H4R3DB01#				±0.1pF	GCQ1555C1H5R7BB01#	
			4.4pF	±0.05pF	GCQ1555C1H4R4WB01#				±0.25pF	GCQ1555C1H5R7CB01#	
				±0.1pF	GCQ1555C1H4R4BB01#	±0.5pF			GCQ1555C1H5R7DB01#		
				±0.25pF	GCQ1555C1H4R4CB01#	5.8pF			±0.05pF	GCQ1555C1H5R8WB01#	
			±0.5pF	GCQ1555C1H4R4DB01#	±0.1pF				GCQ1555C1H5R8BB01#		
			4.5pF	±0.05pF	GCQ1555C1H4R5WB01#				±0.25pF	GCQ1555C1H5R8CB01#	
				±0.1pF	GCQ1555C1H4R5BB01#	±0.5pF			GCQ1555C1H5R8DB01#		
				±0.25pF	GCQ1555C1H4R5CB01#	5.9pF			±0.05pF	GCQ1555C1H5R9WB01#	
				±0.5pF	GCQ1555C1H4R5DB01#				±0.1pF	GCQ1555C1H5R9BB01#	
			4.6pF	±0.05pF	GCQ1555C1H4R6WB01#				±0.25pF	GCQ1555C1H5R9CB01#	
				±0.1pF	GCQ1555C1H4R6BB01#	±0.5pF			GCQ1555C1H5R9DB01#		
				±0.25pF	GCQ1555C1H4R6CB01#	6.0pF			±0.05pF	GCQ1555C1H6R0WB01#	
				±0.5pF	GCQ1555C1H4R6DB01#				±0.1pF	GCQ1555C1H6R0BB01#	
			4.7pF	±0.05pF	GCQ1555C1H4R7WB01#				±0.25pF	GCQ1555C1H6R0CB01#	
				±0.1pF	GCQ1555C1H4R7BB01#	±0.5pF			GCQ1555C1H6R0DB01#		
				±0.25pF	GCQ1555C1H4R7CB01#	6.1pF			±0.05pF	GCQ1555C1H6R1WB01#	
				±0.5pF	GCQ1555C1H4R7DB01#				±0.1pF	GCQ1555C1H6R1BB01#	
			4.8pF	±0.05pF	GCQ1555C1H4R8WB01#				±0.25pF	GCQ1555C1H6R1CB01#	
				±0.1pF	GCQ1555C1H4R8BB01#	±0.5pF			GCQ1555C1H6R1DB01#		
				±0.25pF	GCQ1555C1H4R8CB01#	6.2pF			±0.05pF	GCQ1555C1H6R2WB01#	
				±0.5pF	GCQ1555C1H4R8DB01#				±0.1pF	GCQ1555C1H6R2BB01#	
			4.9pF	±0.05pF	GCQ1555C1H4R9WB01#				±0.25pF	GCQ1555C1H6R2CB01#	
				±0.1pF	GCQ1555C1H4R9BB01#	±0.5pF			GCQ1555C1H6R2DB01#		
				±0.25pF	GCQ1555C1H4R9CB01#	6.3pF			±0.05pF	GCQ1555C1H6R3WB01#	
				±0.5pF	GCQ1555C1H4R9DB01#				±0.1pF	GCQ1555C1H6R3BB01#	
			5.0pF	±0.05pF	GCQ1555C1H5R0WB01#				±0.25pF	GCQ1555C1H6R3CB01#	
				±0.1pF	GCQ1555C1H5R0BB01#	±0.5pF			GCQ1555C1H6R3DB01#		
				±0.25pF	GCQ1555C1H5R0CB01#	6.4pF			±0.05pF	GCQ1555C1H6R4WB01#	
				±0.5pF	GCQ1555C1H5R0DB01#				±0.1pF	GCQ1555C1H6R4BB01#	
			5.1pF	±0.05pF	GCQ1555C1H5R1WB01#				±0.25pF	GCQ1555C1H6R4CB01#	
				±0.1pF	GCQ1555C1H5R1BB01#	±0.5pF			GCQ1555C1H6R4DB01#		
				±0.25pF	GCQ1555C1H5R1CB01#	6.5pF			±0.05pF	GCQ1555C1H6R5WB01#	
				±0.5pF	GCQ1555C1H5R1DB01#				±0.1pF	GCQ1555C1H6R5BB01#	
			5.2pF	±0.05pF	GCQ1555C1H5R2WB01#				±0.25pF	GCQ1555C1H6R5CB01#	
				±0.1pF	GCQ1555C1H5R2BB01#	±0.5pF			GCQ1555C1H6R5DB01#		
				±0.25pF	GCQ1555C1H5R2CB01#	6.6pF			±0.05pF	GCQ1555C1H6R6WB01#	
				±0.5pF	GCQ1555C1H5R2DB01#				±0.1pF	GCQ1555C1H6R6BB01#	

Part number # indicates the package specification code.

GRT Series
 GCM Series
 GC3 Series
 GCJ Series
 GCQ Series
 GCD Series
 GCE Series
 NMF Series
 KCM Series
 KC3 Series
 KCA Series
 GCB Series
 GCG Series
 ⚠Caution /Notice

GCQ Series Temperature Compensating Type Part Number List

(→ 1.0×0.5mm)

T max.	Rated Voltage	TC Code	Cap.	Tol.	Part Number	T max.	Rated Voltage	TC Code	Cap.	Tol.	Part Number
0.55mm	50Vdc	COG	6.6pF	±0.25pF	GCQ1555C1H6R6CB01#	0.55mm	50Vdc	COG	8.0pF	±0.05pF	GCQ1555C1H8ROWB01#
				±0.5pF	GCQ1555C1H6R6DB01#					±0.1pF	GCQ1555C1H8ROBB01#
			6.7pF	±0.05pF	GCQ1555C1H6R7WB01#	±0.25pF			GCQ1555C1H8ROCB01#		
				±0.1pF	GCQ1555C1H6R7BB01#	±0.5pF			GCQ1555C1H8RODB01#		
				±0.25pF	GCQ1555C1H6R7CB01#	8.1pF			±0.05pF	GCQ1555C1H8R1WB01#	
				±0.5pF	GCQ1555C1H6R7DB01#				±0.1pF	GCQ1555C1H8R1BB01#	
			6.8pF	±0.05pF	GCQ1555C1H6R8WB01#				±0.25pF	GCQ1555C1H8R1CB01#	
				±0.1pF	GCQ1555C1H6R8BB01#	±0.5pF			GCQ1555C1H8R1DB01#		
				±0.25pF	GCQ1555C1H6R8CB01#	8.2pF			±0.05pF	GCQ1555C1H8R2WB01#	
			±0.5pF	GCQ1555C1H6R8DB01#	±0.1pF				GCQ1555C1H8R2BB01#		
			6.9pF	±0.05pF	GCQ1555C1H6R9WB01#				±0.25pF	GCQ1555C1H8R2CB01#	
				±0.1pF	GCQ1555C1H6R9BB01#	±0.5pF			GCQ1555C1H8R2DB01#		
				±0.25pF	GCQ1555C1H6R9CB01#	8.3pF			±0.05pF	GCQ1555C1H8R3WB01#	
				±0.5pF	GCQ1555C1H6R9DB01#				±0.1pF	GCQ1555C1H8R3BB01#	
			7.0pF	±0.05pF	GCQ1555C1H7R0WB01#				±0.25pF	GCQ1555C1H8R3CB01#	
				±0.1pF	GCQ1555C1H7R0BB01#	±0.5pF			GCQ1555C1H8R3DB01#		
				±0.25pF	GCQ1555C1H7R0CB01#	8.4pF			±0.05pF	GCQ1555C1H8R4WB01#	
				±0.5pF	GCQ1555C1H7R0DB01#				±0.1pF	GCQ1555C1H8R4BB01#	
			7.1pF	±0.05pF	GCQ1555C1H7R1WB01#				±0.25pF	GCQ1555C1H8R4CB01#	
				±0.1pF	GCQ1555C1H7R1BB01#	±0.5pF			GCQ1555C1H8R4DB01#		
				±0.25pF	GCQ1555C1H7R1CB01#	8.5pF			±0.05pF	GCQ1555C1H8R5WB01#	
				±0.5pF	GCQ1555C1H7R1DB01#				±0.1pF	GCQ1555C1H8R5BB01#	
			7.2pF	±0.05pF	GCQ1555C1H7R2WB01#				±0.25pF	GCQ1555C1H8R5CB01#	
				±0.1pF	GCQ1555C1H7R2BB01#	±0.5pF			GCQ1555C1H8R5DB01#		
				±0.25pF	GCQ1555C1H7R2CB01#	8.6pF			±0.05pF	GCQ1555C1H8R6WB01#	
				±0.5pF	GCQ1555C1H7R2DB01#				±0.1pF	GCQ1555C1H8R6BB01#	
			7.3pF	±0.05pF	GCQ1555C1H7R3WB01#				±0.25pF	GCQ1555C1H8R6CB01#	
				±0.1pF	GCQ1555C1H7R3BB01#	±0.5pF			GCQ1555C1H8R6DB01#		
				±0.25pF	GCQ1555C1H7R3CB01#	8.7pF			±0.05pF	GCQ1555C1H8R7WB01#	
				±0.5pF	GCQ1555C1H7R3DB01#				±0.1pF	GCQ1555C1H8R7BB01#	
			7.4pF	±0.05pF	GCQ1555C1H7R4WB01#				±0.25pF	GCQ1555C1H8R7CB01#	
				±0.1pF	GCQ1555C1H7R4BB01#	±0.5pF			GCQ1555C1H8R7DB01#		
				±0.25pF	GCQ1555C1H7R4CB01#	8.8pF			±0.05pF	GCQ1555C1H8R8WB01#	
				±0.5pF	GCQ1555C1H7R4DB01#				±0.1pF	GCQ1555C1H8R8BB01#	
			7.5pF	±0.05pF	GCQ1555C1H7R5WB01#				±0.25pF	GCQ1555C1H8R8CB01#	
				±0.1pF	GCQ1555C1H7R5BB01#	±0.5pF			GCQ1555C1H8R8DB01#		
				±0.25pF	GCQ1555C1H7R5CB01#	8.9pF			±0.05pF	GCQ1555C1H8R9WB01#	
				±0.5pF	GCQ1555C1H7R5DB01#				±0.1pF	GCQ1555C1H8R9BB01#	
			7.6pF	±0.05pF	GCQ1555C1H7R6WB01#				±0.25pF	GCQ1555C1H8R9CB01#	
				±0.1pF	GCQ1555C1H7R6BB01#	±0.5pF			GCQ1555C1H8R9DB01#		
				±0.25pF	GCQ1555C1H7R6CB01#	9.0pF			±0.05pF	GCQ1555C1H9ROWB01#	
				±0.5pF	GCQ1555C1H7R6DB01#				±0.1pF	GCQ1555C1H9ROBB01#	
			7.7pF	±0.05pF	GCQ1555C1H7R7WB01#				±0.25pF	GCQ1555C1H9ROCB01#	
				±0.1pF	GCQ1555C1H7R7BB01#	±0.5pF			GCQ1555C1H9RODB01#		
				±0.25pF	GCQ1555C1H7R7CB01#	9.1pF			±0.05pF	GCQ1555C1H9R1WB01#	
				±0.5pF	GCQ1555C1H7R7DB01#				±0.1pF	GCQ1555C1H9R1BB01#	
			7.8pF	±0.05pF	GCQ1555C1H7R8WB01#				±0.25pF	GCQ1555C1H9R1CB01#	
				±0.1pF	GCQ1555C1H7R8BB01#	±0.5pF			GCQ1555C1H9R1DB01#		
				±0.25pF	GCQ1555C1H7R8CB01#	9.2pF			±0.05pF	GCQ1555C1H9R2WB01#	
				±0.5pF	GCQ1555C1H7R8DB01#				±0.1pF	GCQ1555C1H9R2BB01#	
			7.9pF	±0.05pF	GCQ1555C1H7R9WB01#				±0.25pF	GCQ1555C1H9R2CB01#	
				±0.1pF	GCQ1555C1H7R9BB01#	±0.5pF			GCQ1555C1H9R2DB01#		
				±0.25pF	GCQ1555C1H7R9CB01#	9.3pF			±0.05pF	GCQ1555C1H9R3WB01#	
				±0.5pF	GCQ1555C1H7R9DB01#				±0.1pF	GCQ1555C1H9R3BB01#	

Part number # indicates the package specification code.

GRT Series
 GCM Series
 GC3 Series
 GCJ Series
 GCQ Series
 GCD Series
 GCE Series
 NMF Series
 KCM Series
 KC3 Series
 KCA Series
 GCB Series
 GCG Series
 ⚠Caution /Notice

GCQ Series Temperature Compensating Type Part Number List

(→ 1.0×0.5mm)

T max.	Rated Voltage	TC Code	Cap.	Tol.	Part Number
0.55mm	50Vdc	COG	9.3pF	±0.25pF	GCQ1555C1H9R3CB01#
				±0.5pF	GCQ1555C1H9R3DB01#
			9.4pF	±0.05pF	GCQ1555C1H9R4WB01#
				±0.1pF	GCQ1555C1H9R4BB01#
				±0.25pF	GCQ1555C1H9R4CB01#
				±0.5pF	GCQ1555C1H9R4DB01#
			9.5pF	±0.05pF	GCQ1555C1H9R5WB01#
				±0.1pF	GCQ1555C1H9R5BB01#
				±0.25pF	GCQ1555C1H9R5CB01#
				±0.5pF	GCQ1555C1H9R5DB01#
			9.6pF	±0.05pF	GCQ1555C1H9R6WB01#
				±0.1pF	GCQ1555C1H9R6BB01#
				±0.25pF	GCQ1555C1H9R6CB01#
				±0.5pF	GCQ1555C1H9R6DB01#
			9.7pF	±0.05pF	GCQ1555C1H9R7WB01#
				±0.1pF	GCQ1555C1H9R7BB01#
				±0.25pF	GCQ1555C1H9R7CB01#
				±0.5pF	GCQ1555C1H9R7DB01#
			9.8pF	±0.05pF	GCQ1555C1H9R8WB01#
				±0.1pF	GCQ1555C1H9R8BB01#
				±0.25pF	GCQ1555C1H9R8CB01#
				±0.5pF	GCQ1555C1H9R8DB01#
			9.9pF	±0.05pF	GCQ1555C1H9R9WB01#
				±0.1pF	GCQ1555C1H9R9BB01#
				±0.25pF	GCQ1555C1H9R9CB01#
				±0.5pF	GCQ1555C1H9R9DB01#
			10pF	±1%	GCQ1555C1H100FB01#
				±2%	GCQ1555C1H100GB01#
				±2.5%	GCQ1555C1H100RB01#
				±5%	GCQ1555C1H100JB01#
			11pF	±1%	GCQ1555C1H110FB01#
				±2%	GCQ1555C1H110GB01#
				±5%	GCQ1555C1H110JB01#
			12pF	±1%	GCQ1555C1H120FB01#
				±2%	GCQ1555C1H120GB01#
				±5%	GCQ1555C1H120JB01#
			13pF	±1%	GCQ1555C1H130FB01#
				±2%	GCQ1555C1H130GB01#
				±5%	GCQ1555C1H130JB01#
			14pF	±1%	GCQ1555C1H140FB01#
				±2%	GCQ1555C1H140GB01#
				±5%	GCQ1555C1H140JB01#
			15pF	±1%	GCQ1555C1H150FB01#
				±2%	GCQ1555C1H150GB01#
				±5%	GCQ1555C1H150JB01#
			16pF	±1%	GCQ1555C1H160FB01#
				±2%	GCQ1555C1H160GB01#
				±5%	GCQ1555C1H160JB01#
			17pF	±1%	GCQ1555C1H170FB01#
				±2%	GCQ1555C1H170GB01#
				±5%	GCQ1555C1H170JB01#
			18pF	±1%	GCQ1555C1H180FB01#
				±2%	GCQ1555C1H180GB01#
				±5%	GCQ1555C1H180JB01#

T max.	Rated Voltage	TC Code	Cap.	Tol.	Part Number
0.55mm	50Vdc	COG	19pF	±1%	GCQ1555C1H190FB01#
				±2%	GCQ1555C1H190GB01#
				±5%	GCQ1555C1H190JB01#
			20pF	±1%	GCQ1555C1H200FB01#
				±2%	GCQ1555C1H200GB01#
				±5%	GCQ1555C1H200JB01#
			22pF	±1%	GCQ1555C1H220FB01#
				±2%	GCQ1555C1H220GB01#
				±5%	GCQ1555C1H220JB01#
			24pF	±1%	GCQ1555C1H240FB01#
				±2%	GCQ1555C1H240GB01#
				±5%	GCQ1555C1H240JB01#
			27pF	±1%	GCQ1555C1H270FB01#
				±2%	GCQ1555C1H270GB01#
				±5%	GCQ1555C1H270JB01#
			30pF	±1%	GCQ1555C1H300FB01#
				±2%	GCQ1555C1H300GB01#
				±5%	GCQ1555C1H300JB01#
			33pF	±1%	GCQ1555C1H330FB01#
				±2%	GCQ1555C1H330GB01#
				±5%	GCQ1555C1H330JB01#
			36pF	±1%	GCQ1555C1H360FB01#
				±2%	GCQ1555C1H360GB01#
				±5%	GCQ1555C1H360JB01#
			39pF	±1%	GCQ1555C1H390FB01#
				±2%	GCQ1555C1H390GB01#
				±5%	GCQ1555C1H390JB01#
			43pF	±1%	GCQ1555C1H430FB01#
				±2%	GCQ1555C1H430GB01#
				±5%	GCQ1555C1H430JB01#
			47pF	±1%	GCQ1555C1H470FB01#
				±2%	GCQ1555C1H470GB01#
				±5%	GCQ1555C1H470JB01#

GRT Series
 GCM Series
 GC3 Series
 GCJ Series
 GCQ Series
 GCD Series
 GCE Series
 NMF Series
 KCM Series
 KC3 Series
 KCA Series
 GCB Series
 GCG Series
 ⚠Caution /Notice

Part number # indicates the package specification code.

MLSC Design Chip Multilayer Ceramic Capacitors for Automotive

GCD Series



Prevents momentary dielectric breakdown by a 2-element array structure!

Features

① Prevents momentary dielectric breakdown by a 2-element array structure!

This product consists of 2 elements arranged in 1 capacitor. It is structured so that even when 1 element is shorted, the other capacitor element will not short.

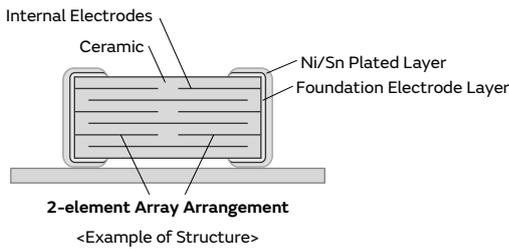

② This AEC-Q200 conforming product is ideal for the battery lines of automotive.

Space can be reduced in battery lines where 2 capacitors are arranged in an array.

Specifications

Size	1.6×0.8mm to 2.0×1.25mm
Rated Voltage	16Vdc to 100Vdc
Capacitance	1000pF to 0.47μF
Main Applications	Battery Lines and Powertrains for automotive

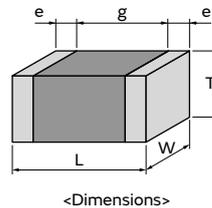

GRT Series
 GCM Series
 GC3 Series
 GCJ Series
 GCQ Series
GCD Series
 GCE Series
 NMF Series
 KCM Series
 KC3 Series
 KCA Series
 GCB Series
 GCG Series
 ⚠Caution /Notice

GCD Series High Dielectric Constant Type Part Number List

1.6×0.8mm

T max.	Rated Voltage	TC Code	Cap.	Tol.	Part Number
0.9mm	100Vdc	X7R	1000pF	±10%	GCD188R72A102KA01#
				±20%	GCD188R72A102MA01#
			1200pF	±10%	GCD188R72A122KA01#
				±20%	GCD188R72A122MA01#
			1500pF	±10%	GCD188R72A152KA01#
				±20%	GCD188R72A152MA01#
			1800pF	±10%	GCD188R72A182KA01#
				±20%	GCD188R72A182MA01#
			2200pF	±10%	GCD188R72A222KA01#
				±20%	GCD188R72A222MA01#
			2700pF	±10%	GCD188R72A272KA01#
				±20%	GCD188R72A272MA01#
			3300pF	±10%	GCD188R72A332KA01#
				±20%	GCD188R72A332MA01#
			3900pF	±10%	GCD188R72A392KA01#
				±20%	GCD188R72A392MA01#
			4700pF	±10%	GCD188R72A472KA01#
				±20%	GCD188R72A472MA01#
			5600pF	±10%	GCD188R72A562KA01#
				±20%	GCD188R72A562MA01#
			6800pF	±10%	GCD188R72A682KA01#
				±20%	GCD188R72A682MA01#
			8200pF	±10%	GCD188R72A822KA01#
				±20%	GCD188R72A822MA01#
	10000pF	±10%	GCD188R72A103KA01#		
		±20%	GCD188R72A103MA01#		
	12000pF	±10%	GCD188R72A123KA01#		
		±20%	GCD188R72A123MA01#		
	15000pF	±10%	GCD188R72A153KA01#		
		±20%	GCD188R72A153MA01#		
	18000pF	±10%	GCD188R72A183KA01#		
		±20%	GCD188R72A183MA01#		
	22000pF	±10%	GCD188R72A223KA01#		
		±20%	GCD188R72A223MA01#		
	50Vdc	X7R	1000pF	±10%	GCD188R71H102KA01#
				±20%	GCD188R71H102MA01#
			1200pF	±10%	GCD188R71H122KA01#
				±20%	GCD188R71H122MA01#
			1500pF	±10%	GCD188R71H152KA01#
				±20%	GCD188R71H152MA01#
			1800pF	±10%	GCD188R71H182KA01#
				±20%	GCD188R71H182MA01#
			2200pF	±10%	GCD188R71H222KA01#
				±20%	GCD188R71H222MA01#
			2700pF	±10%	GCD188R71H272KA01#
				±20%	GCD188R71H272MA01#
			3300pF	±10%	GCD188R71H332KA01#
				±20%	GCD188R71H332MA01#
3900pF			±10%	GCD188R71H392KA01#	
			±20%	GCD188R71H392MA01#	
4700pF			±10%	GCD188R71H472KA01#	
			±20%	GCD188R71H472MA01#	

T max.	Rated Voltage	TC Code	Cap.	Tol.	Part Number
0.9mm	50Vdc	X7R	5600pF	±10%	GCD188R71H562KA01#
				±20%	GCD188R71H562MA01#
			6800pF	±10%	GCD188R71H682KA01#
				±20%	GCD188R71H682MA01#
			8200pF	±10%	GCD188R71H822KA01#
				±20%	GCD188R71H822MA01#
			10000pF	±10%	GCD188R71H103KA01#
				±20%	GCD188R71H103MA01#
			12000pF	±10%	GCD188R71H123KA01#
				±20%	GCD188R71H123MA01#
			15000pF	±10%	GCD188R71H153KA01#
				±20%	GCD188R71H153MA01#
	18000pF	±10%	GCD188R71H183KA01#		
		±20%	GCD188R71H183MA01#		
	22000pF	±10%	GCD188R71H223KA01#		
		±20%	GCD188R71H223MA01#		
	25Vdc	X7R	27000pF	±10%	GCD188R71E273KA01#
				±20%	GCD188R71E273MA01#
			33000pF	±10%	GCD188R71E333KA01#
				±20%	GCD188R71E333MA01#
			39000pF	±10%	GCD188R71E393KA01#
				±20%	GCD188R71E393MA01#
			47000pF	±10%	GCD188R71E473KA01#
				±20%	GCD188R71E473MA01#

2.0×1.25mm

T max.	Rated Voltage	TC Code	Cap.	Tol.	Part Number
1.4mm	100Vdc	X7R	27000pF	±10%	GCD21BR72A273KA01#
				±20%	GCD21BR72A273MA01#
			33000pF	±10%	GCD21BR72A333KA01#
				±20%	GCD21BR72A333MA01#
			39000pF	±10%	GCD21BR72A393KA01#
				±20%	GCD21BR72A393MA01#
			47000pF	±10%	GCD21BR72A473KA01#
				±20%	GCD21BR72A473MA01#
			56000pF	±10%	GCD21BR72A563KA01#
				±20%	GCD21BR72A563MA01#
			68000pF	±10%	GCD21BR72A683KA01#
				±20%	GCD21BR72A683MA01#
	82000pF	±10%	GCD21BR72A823KA01#		
		±20%	GCD21BR72A823MA01#		
	0.10μF	±10%	GCD21BR72A104KA01#		
		±20%	GCD21BR72A104MA01#		
	50Vdc	X7R	27000pF	±10%	GCD21BR71H273KA01#
				±20%	GCD21BR71H273MA01#
			33000pF	±10%	GCD21BR71H333KA01#
				±20%	GCD21BR71H333MA01#
			39000pF	±10%	GCD21BR71H393KA01#
				±20%	GCD21BR71H393MA01#
			47000pF	±10%	GCD21BR71H473KA01#
				±20%	GCD21BR71H473MA01#
56000pF			±10%	GCD21BR71H563KA01#	

Part number # indicates the package specification code.

GRT Series
 GCM Series
 GC3 Series
 GCJ Series
 GCQ Series
 GCD Series
 GCE Series
 NMF Series
 KCM Series
 KC3 Series
 KCA Series
 GCB Series
 GCG Series
 ⚠Caution /Notice

GCD Series High Dielectric Constant Type Part Number List

(→ 2.0×1.25mm)

T max.	Rated Voltage	TC Code	Cap.	Tol.	Part Number
1.4mm	50Vdc	X7R	56000pF	±20%	GCD21BR71H563MA01#
				±10%	GCD21BR71H683KA01#
			68000pF	±20%	GCD21BR71H683MA01#
				±10%	GCD21BR71H823KA01#
			82000pF	±20%	GCD21BR71H823MA01#
				±10%	GCD21BR71H104KA01#
	0.10μF	±10%	GCD21BR71H104MA01#		
		±20%	GCD21BR71H104MA01#		
16Vdc	X7S	0.47μF	±10%	GCD21BC71C474KE01#	

- GRT Series
- GCM Series
- GC3 Series
- GCJ Series
- GCQ Series
- GCD Series**
- GCE Series
- NMF Series
- KCM Series
- KC3 Series
- KCA Series
- GCB Series
- GCG Series
- ⚠Caution /Notice

Part number # indicates the package specification code.

Soft Termination MLSC Design Chip Multilayer Ceramic Capacitors for Automotive

GCE Series



Further improved safety performance with a combination of a 2-element array structure & resin external electrodes!

Features

① **Avoid instantaneous dielectric breakdown with the 2-element array structure**

This product is configured with 2 elements arranged in one capacitor. Even if one element short circuits, the other element in the capacitor does not short.

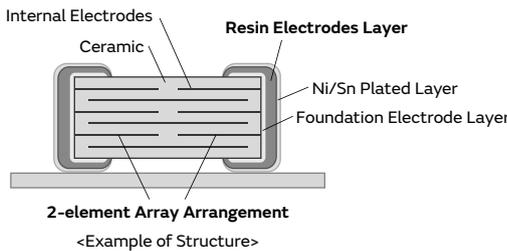

② **Provides additional safety performance in combination with resin electrodes**

Adopting resin electrodes as the external electrodes will suppress the occurrence of cracking in the capacitor by mechanical stress.

● For Automotive (GCM Series)

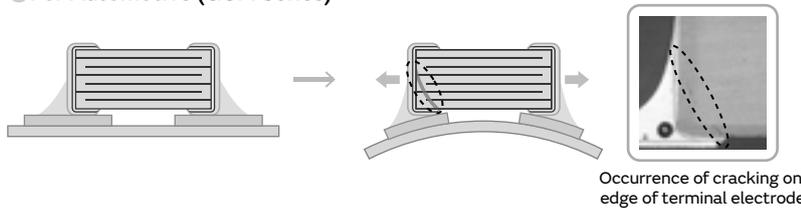

● Fail Safe Design (GCE Series)

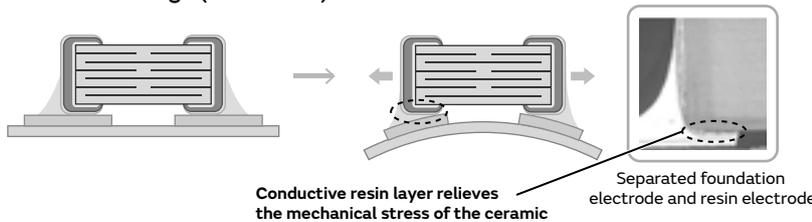

Note: Cracks may occur in the capacitor body if excessive stress beyond the "guaranteed range of board bending strength (*)" provided in the specifications is applied. Capacitors with cracks in them may cause a drop in insulation resistance, which could lead to a short circuit.
 (*) For details on the guaranteed range of board bending strength, check the "Detailed Specification Sheet" on the Product Details Page.

③ **Ideal for battery lines of on-board applications**

Space can be reduced for battery lines, when 2 capacitors are configured in an array.

Specifications

Size	1.6×0.8mm to 2.0×1.25mm
Rated Voltage	25Vdc to 100Vdc
Capacitance	1000pF to 0.10μF
Main Applications	For automotive, Battery lines, power trains

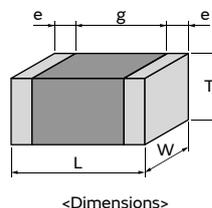

GCE Series High Dielectric Constant Type Part Number List

1.6×0.8mm

T max.	Rated Voltage	TC Code	Cap.	Tol.	Part Number
0.9mm	100Vdc	X7R	1000pF	±10%	GCE188R72A102KA01#
				±20%	GCE188R72A102MA01#
			1200pF	±10%	GCE188R72A122KA01#
				±20%	GCE188R72A122MA01#
			1500pF	±10%	GCE188R72A152KA01#
				±20%	GCE188R72A152MA01#
			1800pF	±10%	GCE188R72A182KA01#
				±20%	GCE188R72A182MA01#
			2200pF	±10%	GCE188R72A222KA01#
				±20%	GCE188R72A222MA01#
			2700pF	±10%	GCE188R72A272KA01#
				±20%	GCE188R72A272MA01#
			3300pF	±10%	GCE188R72A332KA01#
				±20%	GCE188R72A332MA01#
			3900pF	±10%	GCE188R72A392KA01#
				±20%	GCE188R72A392MA01#
			4700pF	±10%	GCE188R72A472KA01#
				±20%	GCE188R72A472MA01#
			5600pF	±10%	GCE188R72A562KA01#
				±20%	GCE188R72A562MA01#
			6800pF	±10%	GCE188R72A682KA01#
				±20%	GCE188R72A682MA01#
			8200pF	±10%	GCE188R72A822KA01#
				±20%	GCE188R72A822MA01#
	10000pF	±10%	GCE188R72A103KA01#		
		±20%	GCE188R72A103MA01#		
	12000pF	±10%	GCE188R72A123KA01#		
		±20%	GCE188R72A123MA01#		
	15000pF	±10%	GCE188R72A153KA01#		
		±20%	GCE188R72A153MA01#		
	18000pF	±10%	GCE188R72A183KA01#		
		±20%	GCE188R72A183MA01#		
	22000pF	±10%	GCE188R72A223KA01#		
		±20%	GCE188R72A223MA01#		
	50Vdc	X7R	1000pF	±10%	GCE188R71H102KA01#
				±20%	GCE188R71H102MA01#
			1200pF	±10%	GCE188R71H122KA01#
				±20%	GCE188R71H122MA01#
			1500pF	±10%	GCE188R71H152KA01#
				±20%	GCE188R71H152MA01#
			1800pF	±10%	GCE188R71H182KA01#
				±20%	GCE188R71H182MA01#
			2200pF	±10%	GCE188R71H222KA01#
				±20%	GCE188R71H222MA01#
			2700pF	±10%	GCE188R71H272KA01#
				±20%	GCE188R71H272MA01#
			3300pF	±10%	GCE188R71H332KA01#
				±20%	GCE188R71H332MA01#
3900pF			±10%	GCE188R71H392KA01#	
			±20%	GCE188R71H392MA01#	
4700pF			±10%	GCE188R71H472KA01#	
			±20%	GCE188R71H472MA01#	

T max.	Rated Voltage	TC Code	Cap.	Tol.	Part Number
0.9mm	50Vdc	X7R	5600pF	±10%	GCE188R71H562KA01#
				±20%	GCE188R71H562MA01#
			6800pF	±10%	GCE188R71H682KA01#
				±20%	GCE188R71H682MA01#
			8200pF	±10%	GCE188R71H822KA01#
				±20%	GCE188R71H822MA01#
			10000pF	±10%	GCE188R71H103KA01#
				±20%	GCE188R71H103MA01#
			12000pF	±10%	GCE188R71H123KA01#
				±20%	GCE188R71H123MA01#
			15000pF	±10%	GCE188R71H153KA01#
				±20%	GCE188R71H153MA01#
	18000pF	±10%	GCE188R71H183KA01#		
		±20%	GCE188R71H183MA01#		
	22000pF	±10%	GCE188R71H223KA01#		
		±20%	GCE188R71H223MA01#		
	25Vdc	X7R	27000pF	±10%	GCE188R71E273KA01#
				±20%	GCE188R71E273MA01#
			33000pF	±10%	GCE188R71E333KA01#
				±20%	GCE188R71E333MA01#
			39000pF	±10%	GCE188R71E393KA01#
				±20%	GCE188R71E393MA01#
			47000pF	±10%	GCE188R71E473KA01#
				±20%	GCE188R71E473MA01#

2.0×1.25mm

T max.	Rated Voltage	TC Code	Cap.	Tol.	Part Number		
1.45mm	100Vdc	X7R	27000pF	±10%	GCE21BR72A273KA01#		
				±20%	GCE21BR72A273MA01#		
			33000pF	±10%	GCE21BR72A333KA01#		
				±20%	GCE21BR72A333MA01#		
			39000pF	±10%	GCE21BR72A393KA01#		
				±20%	GCE21BR72A393MA01#		
			47000pF	±10%	GCE21BR72A473KA01#		
				±20%	GCE21BR72A473MA01#		
			56000pF	±10%	GCE21BR72A563KA01#		
				±20%	GCE21BR72A563MA01#		
			68000pF	±10%	GCE21BR72A683KA01#		
				±20%	GCE21BR72A683MA01#		
			82000pF	±10%	GCE21BR72A823KA01#		
				±20%	GCE21BR72A823MA01#		
			0.10μF	±10%	GCE21BR72A104KA01#		
				±20%	GCE21BR72A104MA01#		
			50Vdc	X7R	27000pF	±10%	GCE21BR71H273KA01#
						±20%	GCE21BR71H273MA01#
	33000pF	±10%			GCE21BR71H333KA01#		
		±20%			GCE21BR71H333MA01#		
	39000pF	±10%			GCE21BR71H393KA01#		
		±20%			GCE21BR71H393MA01#		
	47000pF	±10%			GCE21BR71H473KA01#		
		±20%			GCE21BR71H473MA01#		
	56000pF	±10%			GCE21BR71H563KA01#		

Part number # indicates the package specification code.

GRT Series
 GCM Series
 GC3 Series
 GCJ Series
 GCQ Series
 GCD Series
 GCE Series
 NMF Series
 KCM Series
 KC3 Series
 KCA Series
 GCB Series
 GCG Series
 ⚠Caution / Notice

GCE Series High Dielectric Constant Type Part Number List

(→ 2.0×1.25mm)

T max.	Rated Voltage	TC Code	Cap.	Tol.	Part Number
1.45mm	50Vdc	X7R	56000pF	±20%	GCE21BR71H563MA01#
				±10%	GCE21BR71H683KA01#
			68000pF	±20%	GCE21BR71H683MA01#
				±10%	GCE21BR71H823KA01#
			82000pF	±20%	GCE21BR71H823MA01#
				±10%	GCE21BR71H104KA01#
			0.10μF	±10%	GCE21BR71H104MA01#
				±20%	GCE21BR71H104MA01#

- GRT Series
- GCM Series
- GC3 Series
- GCJ Series
- GCQ Series
- GCD Series
- GCE Series**
- NMF Series
- KCM Series
- KC3 Series
- KCA Series
- GCB Series
- GCG Series
- ⚠Caution /Notice

3 Terminals Low ESL Chip Multilayer Ceramic Capacitors for Automotive

NFM Series      

This is the most suitable Low ESL capacitors for noise measurement and power decoupling of power train and safety equipment.

Features

① Low ESL

Since the equivalent series inductance (ESL) is low and excellent in high frequency characteristics, this capacitor is suitable for power supply decoupling of high-speed operation electronic equipment.

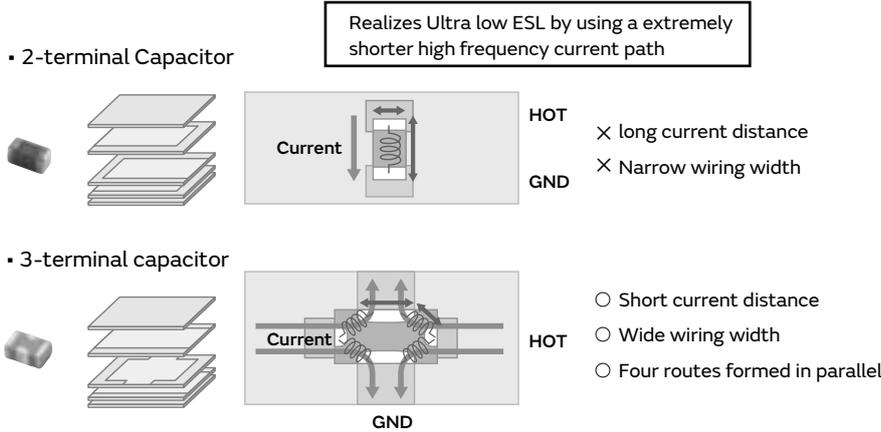

② Contributes to a reduction in the number of components.

The number of components can be reduced by using low ESL capacitors, while maintaining functions equivalent to 2-terminal capacitor.

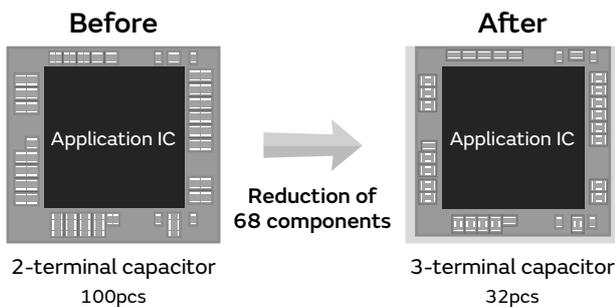

Reference: "How can the mounting area be reduced? — Methods of using low-ESL capacitors —" 

③ Contributes to noise suppression

Example of noise suppression effect 

Reference: "Basics of Noise CountermeasuresLesson 11 Notes on the Use of Chip 3-Terminal Capacitors" 

④ Compliance with AEC-Q200

Use of 3-terminal low-ESL chip multilayer ceramic capacitors to decouple processor power supplies has recently surged in the automotive market due to demand for high performance processors and smaller electronics. This has accompanied the increase in high-functioning multitasking onboard equipment such as advanced driver assistance systems (ADAS), preventative safety systems for automated vehicles, and in-vehicle infotainment (IVI) systems.

GRT Series
 GCM Series
 GC3 Series
 GCJ Series
 GCQ Series
 GCD Series
 GCE Series
 NFM Series
 KCM Series
 KC3 Series
 KCA Series
 GCB Series
 GCG Series
 ⚠Caution /Notice

Specifications

Size	1.6×0.8mm to 3.2×1.6mm
Rated Voltage	6.3Vdc to 100Vdc
Capacitance	220pF to 1.0μF
Main Applications	ADAS processor, Camera sensor, Radar, Lidar

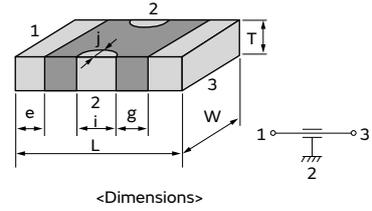

GRT Series

GCM Series

GC3 Series

GCJ Series

GCQ Series

GCD Series

GCE Series

NMF Series

KCM Series

KC3 Series

KCA Series

GCB Series

GCG Series

⚠Caution /Notice

113

NFM Series     **Part Number List**

1.6×0.8mm

T max.	Rated Voltage	Cap.	Tol.	Part Number	
0.7mm	16Vdc	1.0μF	±20%	NFM18HC105C1C3#	
	6.3Vdc	1.0μF	±20%	NFM18HC105C0J3#	

2.0×1.25mm

T max.	Rated Voltage	Cap.	Tol.	Part Number		
0.95mm	50Vdc	220pF	±20%	NFM21HC221R1H3#		
		470pF	±20%	NFM21HC471R1H3#		
		1000pF	±20%	NFM21HC102R1H3#		
		2200pF	±20%	NFM21HC222R1H3#		
		22000pF	±20%	NFM21HC223R1H3#		
	16Vdc	1.0μF	±20%	NFM21HC105R1C3#		
		10Vdc	0.10μF	±20%	NFM21HC104R1A3#	
			0.22μF	±20%	NFM21HC224R1A3#	
			0.47μF	±20%	NFM21HC474R1A3#	

3.2×1.6mm

T max.	Rated Voltage	Cap.	Tol.	Part Number	
1.5mm	100Vdc	10000pF	±20%	NFM31HK103R2A3#	D3
	50Vdc	10000pF	±20%	NFM31HK103R1H3#	D3
		15000pF	±20%	NFM31HK153R1H3#	D3
		22000pF	±20%	NFM31HK223R1H3#	D3
		0.10μF	±20%	NFM31HK104R1H3#	

GRT Series
 GCM Series
 GC3 Series
 GCJ Series
 GCQ Series
 GCD Series
 GCE Series
 NFM Series
 KCM Series
 KC3 Series
 KCA Series
 GCB Series
 GCG Series
 ⚠Caution /Notice

Metal Terminal Type Multilayer Ceramic Capacitors for Automotive

KCM Series



Bonding the metal terminals to external electrodes solves design issues by mounting large size MLCC!

Features

① Bond metal terminals to the external electrodes of chips.

The stress applied to the chip is relieved by the elastic action of the metal terminal.

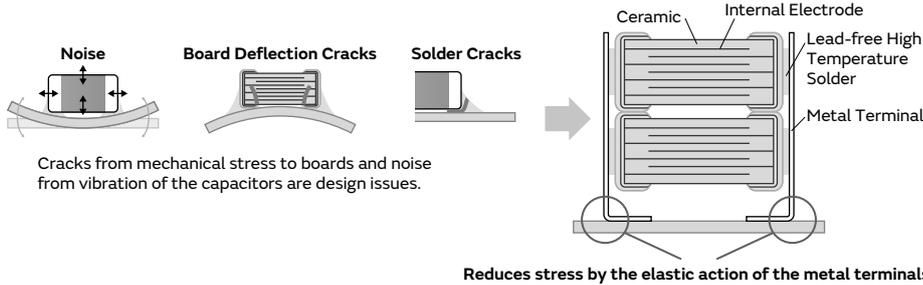

② Substantially reduces noise, board deflection cracks and soldering cracks.

This product is not damaged even with a board deflection of 6 mm.
 Solder cracks do not occur even with 2,000 cycles of heat stress.

● Comparison of Noise Reduction Effects

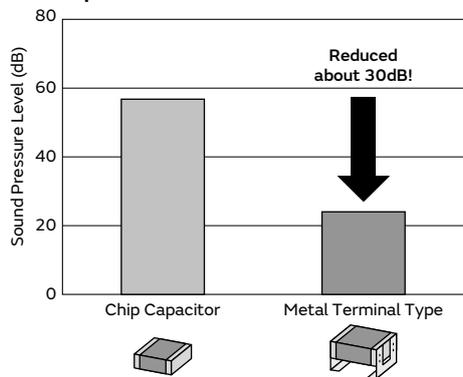

Evaluation Items: 5750 (in mm)/2220 (in inch) size/DC630V/220nF
 Test Method: DC50V, AC10Vp-p/3kHz
 Test Board: Glass Epoxy Board (T=1.6mm)
 Test Quantity: 3pc
 Distance Between Microphone and Board: 5mm

Note: Results Using Murata's Evaluation Board

● Reduces Stress Caused by Board Deflection

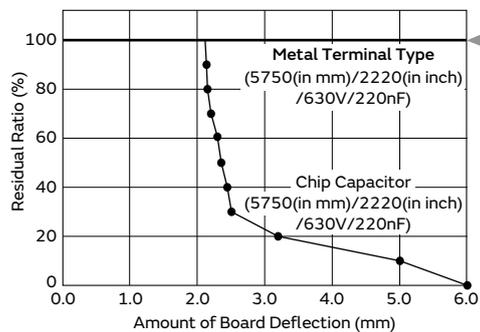

No damage, even with 6 mm board deflection!!

● Suppresses Solder Cracks Caused by Heat Stress

Chip Size	Chip Only (5750 (in mm)/2220 (in inch) size)		Metal Terminal Type (5750 (in mm)/2220 (in inch) size)	
1000 Cycles				
2000 Cycles				

Compared with chips only, this product is excellent in solder cracking resistance.

Test Condition: -55 to +125°C, 5min., (Liquid Phase)
 Board Used: Glass Epoxy Board (FR-4)

③ **2 chips can be stacked.**

Realize large capacity by stacking 2 capacitors.

Specifications

Size	6.1×5.1mm to 6.1×5.3mm
Rated Voltage	25Vdc to 1000Vdc
Capacitance	8200pF to 100μF
Main Applications	For drive system control of engine ECU For other drive system controls and safety devices

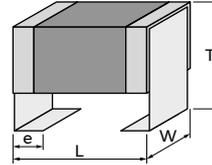

<Dimensions>

GRT Series

GCM Series

GC3 Series

GCJ Series

GCQ Series

GCD Series

GCE Series

NMF Series

KCM Series

KC3 Series

KCA Series

GCB Series

GCG Series

⚠Caution /Notice

116

KCM Series Temperature Compensating Type **Power-train** **AEC-Q200** **Anti-noise** **Deflecting crack** **Soldering crack** Part Number List

6.1×5.1mm

T max.	Rated Voltage	TC Code	Cap.	Tol.	Part Number
3.1mm	1000Vdc	U2J	8200pF	±5%	KCM55L7U3A822JDL1#
			10000pF	±5%	KCM55L7U3A103JDL1#
	630Vdc	COG	0.015μF	±5%	KCM55L5C2J153JDL1#
			0.018μF	±5%	KCM55L5C2J183JDL1#
		U2J	33000pF	±5%	KCM55L7U2J333JDL1#
			39000pF	±5%	KCM55L7U2J393JDL1#
3.9mm	630Vdc	COG	0.022μF	±5%	KCM55R5C2J223JDL1#
			0.027μF	±5%	KCM55R5C2J273JDL1#
5.1mm	1000Vdc	U2J	0.016μF	±10%	KCM55T7U3A163KDL1#
			0.020μF	±10%	KCM55T7U3A203KDL1#
	630Vdc	COG	0.030μF	±5%	KCM55T5C2J303JDL1#
			0.036μF	±5%	KCM55T5C2J363JDL1#
		U2J	66000pF	±10%	KCM55T7U2J663KDL1#
			78000pF	±10%	KCM55T7U2J783KDL1#
6.6mm	630Vdc	COG	0.044μF	±5%	KCM55V5C2J443JDL2#
			0.054μF	±5%	KCM55V5C2J543JDL2#

GRT Series
 GCM Series
 GC3 Series
 GCJ Series
 GCQ Series
 GCD Series
 GCE Series
 NMF Series
KCM Series
 KC3 Series
 KCA Series
 GCB Series
 GCG Series
 ⚠Caution /Notice

KCM Series High Dielectric Constant Type Power-train AEC-Q200 Anti-noise Deflecting crack Soldering crack Part Number List

6.1×5.3mm

T max.	Rated Voltage	TC Code	Cap.	Tol.	Part Number
3.0mm	100Vdc	X7R	4.7μF	±10%	KCM55LR72A475KH01#
	63Vdc	X7R	4.7μF	±10%	KCM55LR71J475KH01#
	50Vdc	X7R	4.7μF	±10%	KCM55LR71H475KH01#
			10μF	±10%	KCM55LR71H106KH01#
	35Vdc	X7R	10μF	±10%	KCM55LR7YA106KH01#
			15μF	±10%	KCM55LR7YA156KH01#
25Vdc	X7R	15μF	±10%	KCM55LR71E156KH01#	
3.9mm	100Vdc	X7R	6.8μF	±10%	KCM55QR72A685KH01#
			10μF	±10%	KCM55QR72A106KH01#
	63Vdc	X7R	10μF	±10%	KCM55QR71J106KH01#
			10μF	±10%	KCM55QR71H106KH01#
	50Vdc	X7R	10μF	±10%	KCM55QR71H106KH01#
			17μF	±10%	KCM55QR71H176KH01#
	35Vdc	X7R	17μF	±10%	KCM55QR7YA176KH01#
			22μF	±10%	KCM55QR7YA226KH01#
	25Vdc	X7R	22μF	±10%	KCM55QR71E226KH01#
			33μF	±10%	KCM55QR71E336KH01#
X7S		47μF	±10%	KCM55QC71E476KH13#	
5.0mm	100Vdc	X7R	10μF	±20%	KCM55TR72A106MH01#
	50Vdc	X7R	22μF	±20%	KCM55TR71H226MH01#
	35Vdc	X7R	22μF	±20%	KCM55TR7YA226MH01#
			33μF	±20%	KCM55TR7YA336MH01#
	25Vdc	X7R	33μF	±20%	KCM55TR71E336MH01#
6.7mm	100Vdc	X7R	15μF	±20%	KCM55WR72A156MH01#
			22μF	±20%	KCM55WR72A226MH01#
	63Vdc	X7R	22μF	±20%	KCM55WR71J226MH01#
			22μF	±20%	KCM55WR71H226MH01#
	50Vdc	X7R	22μF	±20%	KCM55WR71H226MH01#
			33μF	±20%	KCM55WR71H336MH01#
	35Vdc	X7R	33μF	±20%	KCM55WR7YA336MH01#
			47μF	±20%	KCM55WR7YA476MH01#
	25Vdc	X7R	47μF	±20%	KCM55WR71E476MH01#
68μF			±20%	KCM55WR71E686MH01#	
X7S		100μF	±20%	KCM55WC71E107MH13#	

GRT Series
 GCM Series
 GC3 Series
 GCJ Series
 GCQ Series
 GCD Series
 GCE Series
 NMF Series
 KCM Series
 KC3 Series
 KCA Series
 GCB Series
 GCG Series
 ⚠Caution /Notice

High Effective Capacitance & High Allowable Ripple Current Metal Terminal Type Multilayer Ceramic Capacitors for Automotive

KC3 Series



Bonding the metal terminals to external electrodes solves design issues by mounting large size MLCC!

Features

1 Bond Metal Terminals to External Electrodes of Chips

This product has high resistance to heat and mechanical impact and greatly reduces acoustic noise of boards by ceramics.

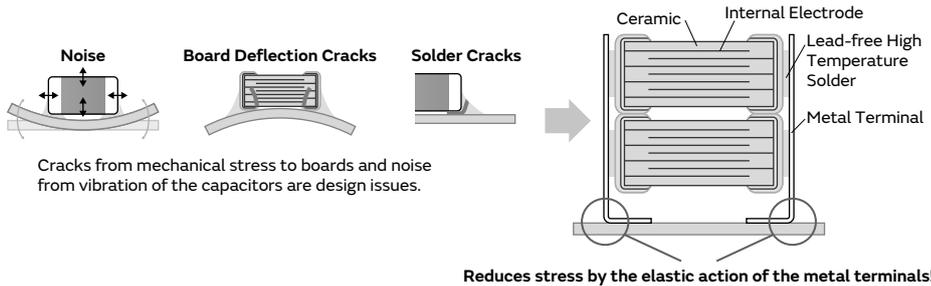

2 Stacking of Chips

Achieve high capacity by stacking 2 capacitors.

Comparison of Noise Reduction Effects

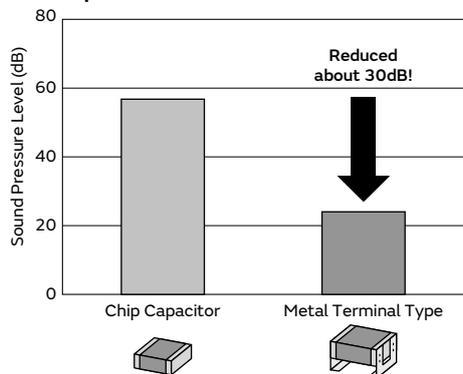

Evaluation Items: 5750 (in mm)/2220 (in inch) size/DC630V/220nF
 Test Method: DC50V, AC10Vp-p/3kHz
 Test Board: Glass Epoxy Board (T=1.6mm)
 Test Quantity: 3pc
 Distance Between Microphone and Board: 5mm

Note: Results Using Murata's Evaluation Board

Reduces Stress Caused by Board Deflection

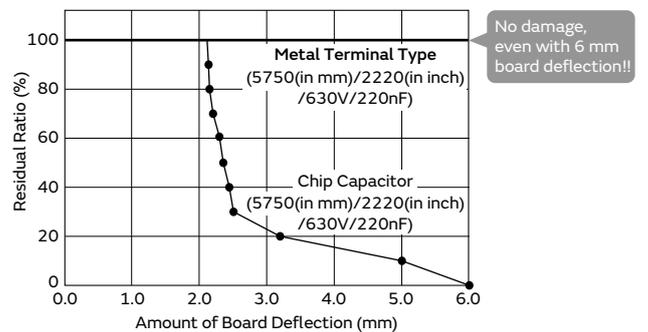

Suppresses Solder Cracks Caused by Heat Stress

Chip Size	Chip Only (5750 (in mm)/2220 (in inch) size)		Metal Terminal Type (5750 (in mm)/2220 (in inch) size)	
1000 Cycles				
2000 Cycles				

Compared with chips only, this product is excellent in solder cracking resistance.

Test Condition: -55 to +125°C, 5min., (Liquid Phase)
 Board Used: Glass Epoxy Board (FR-4)

GRT Series
 GCM Series
 GC3 Series
 GCJ Series
 GCQ Series
 GCD Series
 GCE Series
 NMF Series
 KCM Series
 KC3 Series
 KCA Series
 GCB Series
 GCG Series
 ⚠️Caution / Notice

3 Adopted Low Dielectric Constant Materials

Improved effective capacity and ripple resistant performance, compared to conventional products (X7R characteristics).

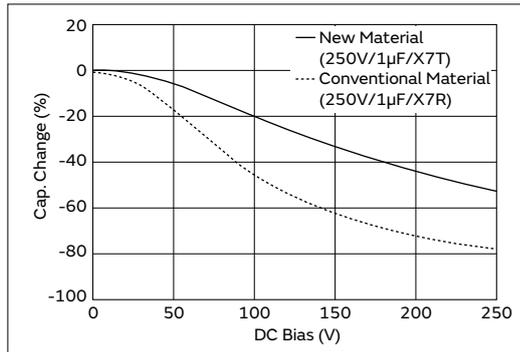

4 2 chips can be stacked

Realize large capacity by stacking 2 capacitors.

Specifications

Size	6.1×5.3mm
Rated Voltage	250Vdc to 630Vdc
Capacitance	0.10µF to 2.2µF
Main Applications	For drive system control of engine ECU For other drive system controls and safety devices

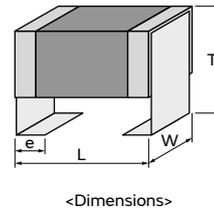

KC3 Series High Dielectric Constant Type **Power-train** **AEC-Q200** **Anti-noise** **Deflecting crack** **Soldering crack** Part Number List

6.1×5.3mm

T max.	Rated Voltage	TC Code	Cap.	Tol.	Part Number	
3.0mm	630Vdc	X7T	0.10μF	±10%	KC355LD72J104KH01#	
			0.15μF	±10%	KC355LD72J154KH01#	
			0.33μF	±10%	KC355LD7LQ334KV01#	D2
			0.47μF	±10%	KC355LD7LQ474KV01#	D2
	450Vdc	X7T	0.22μF	±10%	KC355LD72W224KH01#	
			0.33μF	±10%	KC355LD72W334KH01#	
			0.47μF	±10%	KC355LD72W474KH01#	
			0.68μF	±10%	KC355LD7LP684KV01#	D2
	250Vdc	X7T	0.47μF	±10%	KC355LD72E474KH01#	
			0.68μF	±10%	KC355LD72E684KH01#	
3.9mm	630Vdc	X7T	0.22μF	±10%	KC355QD72J224KH01#	
			0.27μF	±10%	KC355QD72J274KH01#	
			0.56μF	±10%	KC355QD7LQ564KV01#	D2
	450Vdc	X7T	0.56μF	±10%	KC355QD72W564KH01#	
			1.0μF	±10%	KC355QD7LP105KV01#	D2
	250Vdc	X7T	1.0μF	±10%	KC355QD72E105KH01#	
5.0mm	630Vdc	X7T	0.68μF	±20%	KC355TD7LQ684MV01#	D2
			1.0μF	±20%	KC355TD7LQ105MV01#	D2
	450Vdc	X7T	0.68μF	±20%	KC355TD72W684MH01#	
			1.0μF	±20%	KC355TD72W105MH01#	
			1.5μF	±20%	KC355TD7LP155MV01#	D2
	250Vdc	X7T	1.5μF	±20%	KC355TD72E155MH01#	
6.7mm	630Vdc	X7T	0.47μF	±20%	KC355WD72J474MH01#	
			0.56μF	±20%	KC355WD72J564MH01#	
			1.2μF	±20%	KC355WD7LQ125MV01#	D2
	450Vdc	X7T	1.2μF	±20%	KC355WD72W125MH01#	
			2.2μF	±20%	KC355WD7LP225MV01#	D2
	250Vdc	X7T	2.2μF	±20%	KC355WD72E225MH01#	

GRT Series
 GCM Series
 GC3 Series
 GCJ Series
 GCQ Series
 GCD Series
 GCE Series
 NMF Series
 KCM Series
 KC3 Series
 KCA Series
 GCB Series
 GCG Series
 ⚠Caution /Notice

Safety Standard Certified Metal Terminal Type Multilayer Ceramic Capacitors for Automotive

KCA Series



For Automotive IEC60384-14 X1/Y2 Class Certified Product (Basic insulation product)

Features

① **IEC60384-14 certified product: Rated voltage AC250V (r.m.s.).**

Please down load Safety Standard Certification (Type MF: X1,Y2) from Web site.

② **Best suitable for class Y2 capacitors.**

AC250V (r.m.s.)-rated voltage, withstand voltage of AC2000V (r.m.s.) guaranteed for 60 seconds.

● **OBC (On Board Charger)**

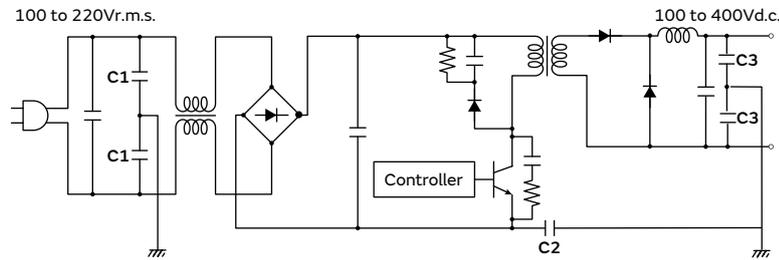

No.	Application
C1	Y Cap (Primary)
C2	Primary-Secondary Coupling
C3	Y Cap (Secondary)

③ **Best suitable for DC input common mode noise filters.**

DC630V-rated voltage, withstand voltage of DC2700V guaranteed for 60 seconds.

● **Inverter**

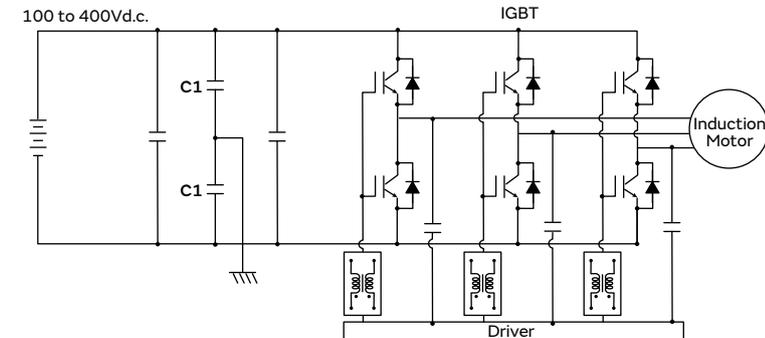

No.	Application
C1	Common mode noise filters

● **DC-DC Converter**

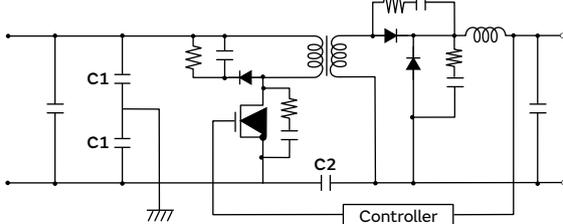

No.	Application
C1	Common mode noise filters
C2	Primary-Secondary Coupling

GRT Series
 GCM Series
 GC3 Series
 GCJ Series
 GCQ Series
 GCD Series
 GCE Series
 NMF Series
 KCM Series
 KCM Series
 KC3 Series
 KCA Series
 GCB Series
 GCG Series
 ⚠Caution / Notice

GRT Series
 GCM Series
 GC3 Series
 GCJ Series
 GCQ Series
 GCD Series
 GCE Series
 NMF Series
 KCM Series
 KC3 Series
 KCA Series
 GCB Series
 GCG Series
 ⚠Caution /Notice

4 Bond metal terminals to the external electrodes of chips.

The stress applied to the chip is relieved by the elastic action of the metal terminal.

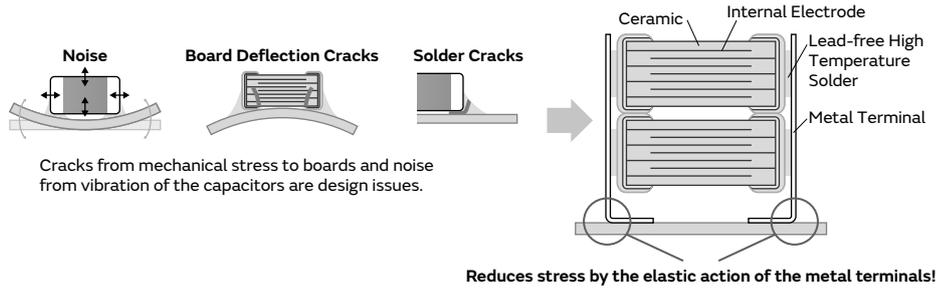

5 Substantially reduces board deflection cracks and soldering cracks.

This product is not damaged even with a board deflection of 6 mm. Solder cracks do not occur even with 2,000 cycles of heat stress.

● Reduces Stress Caused by Board Deflection

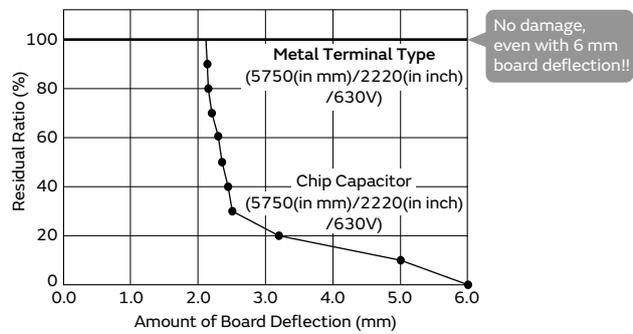

● Suppresses Solder Cracks Caused by Heat Stress

Chip Size	Chip Only (5750 (in mm)/2220 (in inch) size)	Metal Terminal Type (5750 (in mm)/2220 (in inch) size)
1000 Cycles		
2000 Cycles		

Compared with chips only, this product is excellent in solder cracking resistance.

Test Condition: -55 to +125°C, 5min., (Liquid Phase)
 Board Used: Glass Epoxy Board (FR-4)

6 2 chips can be stacked.

Realize large capacity by stacking 2 capacitors.

Specifications

Size	6.1×5.1mm
Rated Voltage	250Vac (r.m.s.)
Capacitance	100pF to 10000pF
Main Applications	Battery chargers, Inverter, DC-DC converters

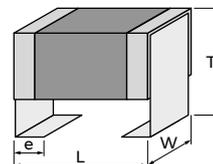

<Dimensions>

KCA Series Temperature Compensating Type       **Part Number List**

6.1×5.1mm

T max.	Rated Voltage	TC Code	Cap.	Tol.	Part Number
3.0mm	250Vac(r.m.s.)	U2J	100pF	±10%	KCA55L7UMF101KL01#
			150pF	±10%	KCA55L7UMF151KL01#
			220pF	±10%	KCA55L7UMF221KL01#
			330pF	±10%	KCA55L7UMF331KL01#
			470pF	±10%	KCA55L7UMF471KL01#
			680pF	±10%	KCA55L7UMF681KL01#
			1000pF	±10%	KCA55L7UMF102KL01#
			1500pF	±10%	KCA55L7UMF152KL01#
			2200pF	±10%	KCA55L7UMF222KL01#
			3300pF	±10%	KCA55L7UMF332KL01#
3.9mm	250Vac(r.m.s.)	U2J	4700pF	±10%	KCA55Q7UMF472KL01#
5.0mm	250Vac(r.m.s.)	U2J	6800pF	±20%	KCA55T7UMF682ML01#
6.7mm	250Vac(r.m.s.)	U2J	10000pF	±20%	KCA55W7UMF103ML01#

GRT Series
 GCM Series
 GC3 Series
 GCJ Series
 GCQ Series
 GCD Series
 GCE Series
 NMF Series
 KCM Series
 KC3 Series
 KCA Series
 GCB Series
 GCG Series
 ⚠Caution /Notice

Part number # indicates the package specification code.

Ni Plating + Pd Plating Termination Conductive Glue Mounting Chip Multilayer Ceramic Capacitors for Automotive

GCB Series



Monolithic ceramic capacitor limited to conductive glue mounting and that can be used even in high-temperature environments at 200°C

Features

1 Limited to Conductive Glue Mounting

These monolithic ceramic capacitors support the electrically conductive adhesives*, now being used in the powertrains and safety devices of automobiles, complying with the AEC-Q200 stress test qualification for passive components.

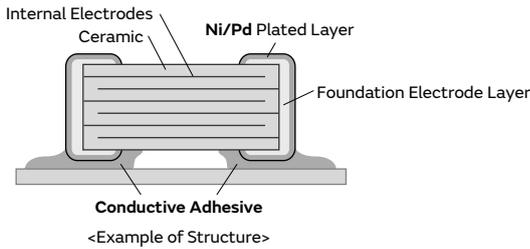

2 Palladium plating used for external electrodes

Palladium (Pd) is employed for the plating surfaces of the external electrodes of these capacitors, and a high bonding reliability with electrically conductive adhesives is achieved as a result even during use in high-temperature environments. Furthermore, the terminal electrodes of the capacitors have a superior corrosion resistance compared with our previously available product, the GCG series.

3 Ability to function at temperatures up to 200°C

Products that can be used at temperatures up to 200°C have now been made available, and they are ideally suited to the products and devices that are installed in automobiles and work in high-temperature conditions.

* This product is for use exclusively with conductive glue mounting. It cannot be used with any mounting methods other than conductive glue mounting.

Using solder to mount the product can result in insufficient wetting, insufficient bonding strength, and/or leaching of the Ag/Pd External Electrodes (terminations), which can cause quality problems such as the chip coming loose.

Specifications

Size	1.0×0.5mm
Rated Voltage	16Vdc to 100Vdc
Capacitance	1000pF to 0.10μF
Main Applications	Sensors and small-sized motors used in automobiles (appears there is content missing here)

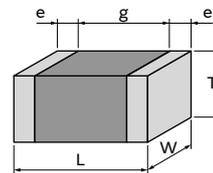

<Dimensions>

GRT Series
 GCM Series
 GC3 Series
 GCJ Series
 GCQ Series
 GCD Series
 GCE Series
 NMF Series
 KCM Series
 KC3 Series
 KCA Series
 GCB Series
 GCG Series
 ⚠Caution / Notice

GCB Series High Dielectric Constant Type Part Number List

1.0×0.5mm

T max.	Rated Voltage	TC Code	Cap.	Tol.	Part Number
0.55mm	100Vdc	X8R	1000pF	±10%	GCB155R92A102KE03#
			1500pF	±10%	GCB155R92A152KE03#
			2200pF	±10%	GCB155R92A222KE03#
			3300pF	±10%	GCB155R92A332KE03#
			4700pF	±10%	GCB155R92A472KE03#
			6800pF	±10%	GCB155R92A682KE03#
			10000pF	±10%	GCB155R92A103KE03#
	50Vdc	X8R	1000pF	±10%	GCB155R91H102KE01#
			1500pF	±10%	GCB155R91H152KE01#
			2200pF	±10%	GCB155R91H222KE01#
			3300pF	±10%	GCB155R91H332KE01#
			4700pF	±10%	GCB155R91H472KE01#
			15000pF	±10%	GCB155R91H153KE03#
			22000pF	±10%	GCB155R91H223KE03#
			33000pF	±10%	GCB155R91H333KE03#
	25Vdc	X8R	6800pF	±10%	GCB155R91E682KE01#
			10000pF	±10%	GCB155R91E103KE01#
			47000pF	±10%	GCB155R91E473KE03#
			68000pF	±10%	GCB155R91E683KE03#
			0.10μF	±10%	GCB155R91E104KE03#
	16Vdc	X8R	15000pF	±10%	GCB155R91C153KE01#
			22000pF	±10%	GCB155R91C223KE01#
			33000pF	±10%	GCB155R91C333KE01#
			47000pF	±10%	GCB155R91C473KE01#
			68000pF	±10%	GCB155R91C683KE01#
			0.10μF	±10%	GCB155R91C104KE01#

GRT Series
 GCM Series
 GC3 Series
 GCJ Series
 GCQ Series
 GCD Series
 GCE Series
 NMF Series
 KCM Series
 KC3 Series
 KCA Series
 GCB Series
 GCG Series
 ⚠Caution /Notice

AgPd Termination Conductive Glue Mounting Chip Multilayer Ceramic Capacitors for Automotive

GCG Series



Improved mechanical and thermal strength by adopting AgPd external electrodes, which can be mounted with a conductive glue!

Features

① **Limited to Conductive Glue Mounting**

This capacitor can be mounted with a conductive adhesive* in powertrains and safety devices of automotive.

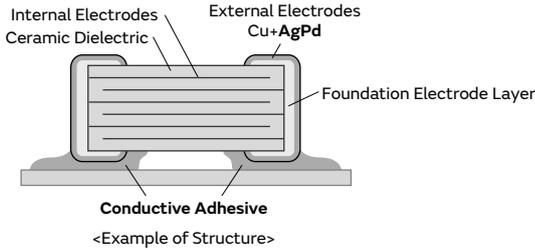

② **Adopted AgPd external electrodes**

Adopted AgPd, which is excellent in bonding strength with a conductive adhesive.

③ **Compatible up to 150°C**

This capacitor lineup with X8L and X8R characteristics can be used in high temperature environments, such as in ABS and transmission control.

* This product is for use exclusively with conductive glue mounting. It cannot be used with any mounting methods other than conductive glue mounting.

Using solder to mount the product can result in insufficient wetting, insufficient bonding strength, and/or leaching of the Ag/Pd External Electrodes (terminations), which can cause quality problems such as the chip coming loose.

Specifications

Size	1.0×0.5mm to 3.2×2.5mm
Rated Voltage	6.3Vdc to 100Vdc
Capacitance	1.0pF to 47μF
Main Applications	For automotive, power trains, sensors

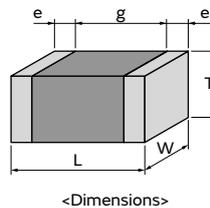

GRT Series
 GCM Series
 GC3 Series
 GCJ Series
 GCQ Series
 GCD Series
 GCE Series
 NMF Series
 KCM Series
 KC3 Series
 KCA Series
 GCB Series
 GCG Series
 ⚠Caution /Notice

GCG Series Temperature Compensating Type Part Number List

1.0×0.5mm

T max.	Rated Voltage	TC Code	Cap.	Tol.	Part Number
0.55mm	50Vdc	COG	1.0pF	±0.1pF	GCG1555C1H1R0BA01#
				±0.25pF	GCG1555C1H1R0CA01#
				±0.5pF	GCG1555C1H1R0DA01#
			1.1pF	±0.1pF	GCG1555C1H1R1BA01#
				±0.25pF	GCG1555C1H1R1CA01#
				±0.5pF	GCG1555C1H1R1DA01#
			1.2pF	±0.1pF	GCG1555C1H1R2BA01#
				±0.25pF	GCG1555C1H1R2CA01#
				±0.5pF	GCG1555C1H1R2DA01#
			1.3pF	±0.1pF	GCG1555C1H1R3BA01#
				±0.25pF	GCG1555C1H1R3CA01#
				±0.5pF	GCG1555C1H1R3DA01#
			1.4pF	±0.1pF	GCG1555C1H1R4BA01#
				±0.25pF	GCG1555C1H1R4CA01#
				±0.5pF	GCG1555C1H1R4DA01#
			1.5pF	±0.1pF	GCG1555C1H1R5BA01#
				±0.25pF	GCG1555C1H1R5CA01#
				±0.5pF	GCG1555C1H1R5DA01#
			1.6pF	±0.1pF	GCG1555C1H1R6BA01#
				±0.25pF	GCG1555C1H1R6CA01#
				±0.5pF	GCG1555C1H1R6DA01#
			1.7pF	±0.1pF	GCG1555C1H1R7BA01#
				±0.25pF	GCG1555C1H1R7CA01#
				±0.5pF	GCG1555C1H1R7DA01#
			1.8pF	±0.1pF	GCG1555C1H1R8BA01#
				±0.25pF	GCG1555C1H1R8CA01#
				±0.5pF	GCG1555C1H1R8DA01#
			1.9pF	±0.1pF	GCG1555C1H1R9BA01#
				±0.25pF	GCG1555C1H1R9CA01#
				±0.5pF	GCG1555C1H1R9DA01#
			2.0pF	±0.1pF	GCG1555C1H2R0BA01#
				±0.25pF	GCG1555C1H2R0CA01#
				±0.5pF	GCG1555C1H2R0DA01#
			2.1pF	±0.1pF	GCG1555C1H2R1BA01#
				±0.25pF	GCG1555C1H2R1CA01#
				±0.5pF	GCG1555C1H2R1DA01#
			2.2pF	±0.1pF	GCG1555C1H2R2BA01#
				±0.25pF	GCG1555C1H2R2CA01#
				±0.5pF	GCG1555C1H2R2DA01#
			2.3pF	±0.1pF	GCG1555C1H2R3BA01#
				±0.25pF	GCG1555C1H2R3CA01#
				±0.5pF	GCG1555C1H2R3DA01#
			2.4pF	±0.1pF	GCG1555C1H2R4BA01#
				±0.25pF	GCG1555C1H2R4CA01#
				±0.5pF	GCG1555C1H2R4DA01#
			2.5pF	±0.1pF	GCG1555C1H2R5BA01#
				±0.25pF	GCG1555C1H2R5CA01#
				±0.5pF	GCG1555C1H2R5DA01#
			2.6pF	±0.1pF	GCG1555C1H2R6BA01#
				±0.25pF	GCG1555C1H2R6CA01#
				±0.5pF	GCG1555C1H2R6DA01#
			2.7pF	±0.1pF	GCG1555C1H2R7BA01#

T max.	Rated Voltage	TC Code	Cap.	Tol.	Part Number
0.55mm	50Vdc	COG	2.7pF	±0.25pF	GCG1555C1H2R7CA01#
				±0.5pF	GCG1555C1H2R7DA01#
			2.8pF	±0.1pF	GCG1555C1H2R8BA01#
				±0.25pF	GCG1555C1H2R8CA01#
				±0.5pF	GCG1555C1H2R8DA01#
			2.9pF	±0.1pF	GCG1555C1H2R9BA01#
				±0.25pF	GCG1555C1H2R9CA01#
				±0.5pF	GCG1555C1H2R9DA01#
			3.0pF	±0.1pF	GCG1555C1H3R0BA01#
				±0.25pF	GCG1555C1H3R0CA01#
				±0.5pF	GCG1555C1H3R0DA01#
			3.1pF	±0.1pF	GCG1555C1H3R1BA01#
				±0.25pF	GCG1555C1H3R1CA01#
				±0.5pF	GCG1555C1H3R1DA01#
			3.2pF	±0.1pF	GCG1555C1H3R2BA01#
				±0.25pF	GCG1555C1H3R2CA01#
				±0.5pF	GCG1555C1H3R2DA01#
			3.3pF	±0.1pF	GCG1555C1H3R3BA01#
				±0.25pF	GCG1555C1H3R3CA01#
				±0.5pF	GCG1555C1H3R3DA01#
			3.4pF	±0.1pF	GCG1555C1H3R4BA01#
				±0.25pF	GCG1555C1H3R4CA01#
				±0.5pF	GCG1555C1H3R4DA01#
			3.5pF	±0.1pF	GCG1555C1H3R5BA01#
				±0.25pF	GCG1555C1H3R5CA01#
				±0.5pF	GCG1555C1H3R5DA01#
			3.6pF	±0.1pF	GCG1555C1H3R6BA01#
				±0.25pF	GCG1555C1H3R6CA01#
				±0.5pF	GCG1555C1H3R6DA01#
			3.7pF	±0.1pF	GCG1555C1H3R7BA01#
				±0.25pF	GCG1555C1H3R7CA01#
				±0.5pF	GCG1555C1H3R7DA01#
			3.8pF	±0.1pF	GCG1555C1H3R8BA01#
				±0.25pF	GCG1555C1H3R8CA01#
				±0.5pF	GCG1555C1H3R8DA01#
			3.9pF	±0.1pF	GCG1555C1H3R9BA01#
				±0.25pF	GCG1555C1H3R9CA01#
				±0.5pF	GCG1555C1H3R9DA01#
			4.0pF	±0.1pF	GCG1555C1H4R0BA01#
				±0.25pF	GCG1555C1H4R0CA01#
				±0.5pF	GCG1555C1H4R0DA01#
			4.1pF	±0.1pF	GCG1555C1H4R1BA01#
				±0.25pF	GCG1555C1H4R1CA01#
				±0.5pF	GCG1555C1H4R1DA01#
			4.2pF	±0.1pF	GCG1555C1H4R2BA01#
				±0.25pF	GCG1555C1H4R2CA01#
				±0.5pF	GCG1555C1H4R2DA01#
			4.3pF	±0.1pF	GCG1555C1H4R3BA01#
				±0.25pF	GCG1555C1H4R3CA01#
				±0.5pF	GCG1555C1H4R3DA01#
			4.4pF	±0.1pF	GCG1555C1H4R4BA01#
				±0.25pF	GCG1555C1H4R4CA01#
				±0.5pF	GCG1555C1H4R4DA01#
			4.5pF	±0.1pF	GCG1555C1H4R5BA01#

Part number # indicates the package specification code.

GRT Series
 GCM Series
 GC3 Series
 GCJ Series
 GCQ Series
 GCD Series
 GCE Series
 NMF Series
 KCM Series
 KC3 Series
 KCA Series
 GCB Series
 GCG Series
 ⚠Caution /Notice

GCG Series Temperature Compensating Type Part Number List

(→ 1.0×0.5mm)

T max.	Rated Voltage	TC Code	Cap.	Tol.	Part Number	T max.	Rated Voltage	TC Code	Cap.	Tol.	Part Number
0.55mm	50Vdc	COG	4.5pF	±0.25pF	GCG1555C1H4R5CA01#	0.55mm	50Vdc	COG	6.3pF	±0.25pF	GCG1555C1H6R3CA01#
				±0.5pF	GCG1555C1H4R5DA01#					±0.5pF	GCG1555C1H6R3DA01#
			4.6pF	±0.1pF	GCG1555C1H4R6BA01#				6.4pF	±0.1pF	GCG1555C1H6R4BA01#
				±0.25pF	GCG1555C1H4R6CA01#					±0.25pF	GCG1555C1H6R4CA01#
			4.7pF	±0.5pF	GCG1555C1H4R6DA01#				6.5pF	±0.5pF	GCG1555C1H6R4DA01#
				±0.1pF	GCG1555C1H4R7BA01#					±0.1pF	GCG1555C1H6R5BA01#
			4.8pF	±0.25pF	GCG1555C1H4R7CA01#				6.6pF	±0.25pF	GCG1555C1H6R5CA01#
				±0.5pF	GCG1555C1H4R7DA01#					±0.5pF	GCG1555C1H6R5DA01#
			4.9pF	±0.1pF	GCG1555C1H4R8BA01#				6.7pF	±0.1pF	GCG1555C1H6R6BA01#
				±0.25pF	GCG1555C1H4R8CA01#					±0.25pF	GCG1555C1H6R6CA01#
			5.0pF	±0.5pF	GCG1555C1H4R8DA01#				6.8pF	±0.5pF	GCG1555C1H6R6DA01#
				±0.1pF	GCG1555C1H4R9BA01#					±0.1pF	GCG1555C1H6R7BA01#
			5.1pF	±0.25pF	GCG1555C1H4R9CA01#				6.9pF	±0.25pF	GCG1555C1H6R7CA01#
				±0.5pF	GCG1555C1H4R9DA01#					±0.5pF	GCG1555C1H6R7DA01#
			5.2pF	±0.1pF	GCG1555C1H5R0BA01#				7.0pF	±0.1pF	GCG1555C1H6R8BA01#
				±0.25pF	GCG1555C1H5R0CA01#					±0.25pF	GCG1555C1H6R8CA01#
			5.3pF	±0.5pF	GCG1555C1H5R0DA01#				7.1pF	±0.5pF	GCG1555C1H6R8DA01#
				±0.1pF	GCG1555C1H5R1BA01#					±0.1pF	GCG1555C1H6R9BA01#
			5.4pF	±0.25pF	GCG1555C1H5R1CA01#				7.2pF	±0.25pF	GCG1555C1H6R9CA01#
				±0.5pF	GCG1555C1H5R1DA01#					±0.5pF	GCG1555C1H6R9DA01#
			5.5pF	±0.1pF	GCG1555C1H5R2BA01#				7.3pF	±0.1pF	GCG1555C1H7R0BA01#
				±0.25pF	GCG1555C1H5R2CA01#					±0.25pF	GCG1555C1H7R0CA01#
			5.6pF	±0.5pF	GCG1555C1H5R2DA01#				7.4pF	±0.5pF	GCG1555C1H7R0DA01#
				±0.1pF	GCG1555C1H5R3BA01#					±0.1pF	GCG1555C1H7R1BA01#
			5.7pF	±0.25pF	GCG1555C1H5R3CA01#				7.5pF	±0.25pF	GCG1555C1H7R1CA01#
				±0.5pF	GCG1555C1H5R3DA01#					±0.5pF	GCG1555C1H7R1DA01#
			5.8pF	±0.1pF	GCG1555C1H5R4BA01#				7.6pF	±0.1pF	GCG1555C1H7R2BA01#
				±0.25pF	GCG1555C1H5R4CA01#					±0.25pF	GCG1555C1H7R2CA01#
			5.9pF	±0.5pF	GCG1555C1H5R4DA01#				7.7pF	±0.5pF	GCG1555C1H7R2DA01#
				±0.1pF	GCG1555C1H5R5BA01#					±0.1pF	GCG1555C1H7R3BA01#
			6.0pF	±0.25pF	GCG1555C1H5R5CA01#				7.8pF	±0.25pF	GCG1555C1H7R3CA01#
				±0.5pF	GCG1555C1H5R5DA01#					±0.5pF	GCG1555C1H7R3DA01#
			6.1pF	±0.1pF	GCG1555C1H5R6BA01#				7.9pF	±0.1pF	GCG1555C1H7R4BA01#
				±0.25pF	GCG1555C1H5R6CA01#					±0.25pF	GCG1555C1H7R4CA01#
			6.2pF	±0.5pF	GCG1555C1H5R6DA01#				8.0pF	±0.5pF	GCG1555C1H7R4DA01#
				±0.1pF	GCG1555C1H5R7BA01#					±0.1pF	GCG1555C1H7R5BA01#
			6.3pF	±0.25pF	GCG1555C1H5R7CA01#				8.1pF	±0.25pF	GCG1555C1H7R5CA01#
				±0.5pF	GCG1555C1H5R7DA01#					±0.5pF	GCG1555C1H7R5DA01#
			6.4pF	±0.1pF	GCG1555C1H5R8BA01#				8.2pF	±0.1pF	GCG1555C1H7R6BA01#
				±0.25pF	GCG1555C1H5R8CA01#					±0.25pF	GCG1555C1H7R6CA01#
			6.5pF	±0.5pF	GCG1555C1H5R8DA01#				8.3pF	±0.5pF	GCG1555C1H7R6DA01#
				±0.1pF	GCG1555C1H5R9BA01#					±0.1pF	GCG1555C1H7R7BA01#
6.6pF	±0.25pF	GCG1555C1H5R9CA01#	8.4pF	±0.25pF	GCG1555C1H7R7CA01#						
	±0.5pF	GCG1555C1H5R9DA01#		±0.5pF	GCG1555C1H7R7DA01#						
6.7pF	±0.1pF	GCG1555C1H6R0BA01#	8.5pF	±0.1pF	GCG1555C1H7R8BA01#						
	±0.25pF	GCG1555C1H6R0CA01#		±0.25pF	GCG1555C1H7R8CA01#						
6.8pF	±0.5pF	GCG1555C1H6R0DA01#	8.6pF	±0.5pF	GCG1555C1H7R8DA01#						
	±0.1pF	GCG1555C1H6R1BA01#		±0.1pF	GCG1555C1H7R9BA01#						
6.9pF	±0.25pF	GCG1555C1H6R1CA01#	8.7pF	±0.25pF	GCG1555C1H7R9CA01#						
	±0.5pF	GCG1555C1H6R1DA01#		±0.5pF	GCG1555C1H7R9DA01#						
7.0pF	±0.1pF	GCG1555C1H6R2BA01#	8.8pF	±0.1pF	GCG1555C1H8R0BA01#						
	±0.25pF	GCG1555C1H6R2CA01#		±0.25pF	GCG1555C1H8R0CA01#						
7.1pF	±0.5pF	GCG1555C1H6R2DA01#	8.9pF	±0.5pF	GCG1555C1H8R0DA01#						
	±0.1pF	GCG1555C1H6R3BA01#		±0.1pF	GCG1555C1H8R1BA01#						

Part number # indicates the package specification code.

GRT Series
 GCM Series
 GC3 Series
 GCJ Series
 GCQ Series
 GCD Series
 GCE Series
 NMF Series
 KCM Series
 KC3 Series
 KCA Series
 GCB Series
 GCG Series
 ⚠Caution /Notice

GCG Series Temperature Compensating Type Part Number List

(→ 1.0×0.5mm)

T max.	Rated Voltage	TC Code	Cap.	Tol.	Part Number	T max.	Rated Voltage	TC Code	Cap.	Tol.	Part Number	
0.55mm	50Vdc	COG	8.1pF	±0.25pF	GCG1555C1H8R1CA01#	0.55mm	50Vdc	COG	9.9pF	±0.25pF	GCG1555C1H9R9CA01#	
				±0.5pF	GCG1555C1H8R1DA01#					±0.5pF	GCG1555C1H9R9DA01#	
			8.2pF	±0.1pF	GCG1555C1H8R2BA01#					10pF	±1%	GCG1555C1H100FA01#
				±0.25pF	GCG1555C1H8R2CA01#						±2.5%	GCG1555C1H100RA01#
				±0.5pF	GCG1555C1H8R2DA01#				±5%		GCG1555C1H100JA01#	
			8.3pF	±0.1pF	GCG1555C1H8R3BA01#				CH	1.0pF	±0.1pF	GCG1552C1H1R0BA01#
				±0.25pF	GCG1555C1H8R3CA01#						±0.25pF	GCG1552C1H1R0CA01#
				±0.5pF	GCG1555C1H8R3DA01#						±0.5pF	GCG1552C1H1R0DA01#
			8.4pF	±0.1pF	GCG1555C1H8R4BA01#				1.1pF	±0.1pF	GCG1552C1H1R1BA01#	
				±0.25pF	GCG1555C1H8R4CA01#					±0.25pF	GCG1552C1H1R1CA01#	
				±0.5pF	GCG1555C1H8R4DA01#					±0.5pF	GCG1552C1H1R1DA01#	
			8.5pF	±0.1pF	GCG1555C1H8R5BA01#				1.2pF	±0.1pF	GCG1552C1H1R2BA01#	
				±0.25pF	GCG1555C1H8R5CA01#					±0.25pF	GCG1552C1H1R2CA01#	
				±0.5pF	GCG1555C1H8R5DA01#					±0.5pF	GCG1552C1H1R2DA01#	
			8.6pF	±0.1pF	GCG1555C1H8R6BA01#				1.3pF	±0.1pF	GCG1552C1H1R3BA01#	
				±0.25pF	GCG1555C1H8R6CA01#					±0.25pF	GCG1552C1H1R3CA01#	
				±0.5pF	GCG1555C1H8R6DA01#					±0.5pF	GCG1552C1H1R3DA01#	
			8.7pF	±0.1pF	GCG1555C1H8R7BA01#				1.4pF	±0.1pF	GCG1552C1H1R4BA01#	
				±0.25pF	GCG1555C1H8R7CA01#					±0.25pF	GCG1552C1H1R4CA01#	
				±0.5pF	GCG1555C1H8R7DA01#					±0.5pF	GCG1552C1H1R4DA01#	
			8.8pF	±0.1pF	GCG1555C1H8R8BA01#				1.5pF	±0.1pF	GCG1552C1H1R5BA01#	
				±0.25pF	GCG1555C1H8R8CA01#					±0.25pF	GCG1552C1H1R5CA01#	
				±0.5pF	GCG1555C1H8R8DA01#					±0.5pF	GCG1552C1H1R5DA01#	
			8.9pF	±0.1pF	GCG1555C1H8R9BA01#				1.6pF	±0.1pF	GCG1552C1H1R6BA01#	
				±0.25pF	GCG1555C1H8R9CA01#					±0.25pF	GCG1552C1H1R6CA01#	
				±0.5pF	GCG1555C1H8R9DA01#					±0.5pF	GCG1552C1H1R6DA01#	
			9.0pF	±0.1pF	GCG1555C1H9R0BA01#				1.7pF	±0.1pF	GCG1552C1H1R7BA01#	
				±0.25pF	GCG1555C1H9R0CA01#					±0.25pF	GCG1552C1H1R7CA01#	
				±0.5pF	GCG1555C1H9R0DA01#					±0.5pF	GCG1552C1H1R7DA01#	
			9.1pF	±0.1pF	GCG1555C1H9R1BA01#				1.8pF	±0.1pF	GCG1552C1H1R8BA01#	
				±0.25pF	GCG1555C1H9R1CA01#					±0.25pF	GCG1552C1H1R8CA01#	
				±0.5pF	GCG1555C1H9R1DA01#					±0.5pF	GCG1552C1H1R8DA01#	
			9.2pF	±0.1pF	GCG1555C1H9R2BA01#				1.9pF	±0.1pF	GCG1552C1H1R9BA01#	
				±0.25pF	GCG1555C1H9R2CA01#					±0.25pF	GCG1552C1H1R9CA01#	
				±0.5pF	GCG1555C1H9R2DA01#					±0.5pF	GCG1552C1H1R9DA01#	
			9.3pF	±0.1pF	GCG1555C1H9R3BA01#				2.0pF	±0.1pF	GCG1552C1H2R0BA01#	
				±0.25pF	GCG1555C1H9R3CA01#					±0.25pF	GCG1552C1H2R0CA01#	
				±0.5pF	GCG1555C1H9R3DA01#					±0.5pF	GCG1552C1H2R0DA01#	
			9.4pF	±0.1pF	GCG1555C1H9R4BA01#				2.1pF	±0.1pF	GCG1552C1H2R1BA01#	
				±0.25pF	GCG1555C1H9R4CA01#					±0.25pF	GCG1552C1H2R1CA01#	
				±0.5pF	GCG1555C1H9R4DA01#					±0.5pF	GCG1552C1H2R1DA01#	
			9.5pF	±0.1pF	GCG1555C1H9R5BA01#				2.2pF	±0.1pF	GCG1552C1H2R2BA01#	
				±0.25pF	GCG1555C1H9R5CA01#					±0.25pF	GCG1552C1H2R2CA01#	
				±0.5pF	GCG1555C1H9R5DA01#					±0.5pF	GCG1552C1H2R2DA01#	
			9.6pF	±0.1pF	GCG1555C1H9R6BA01#				2.3pF	±0.1pF	GCG1552C1H2R3BA01#	
				±0.25pF	GCG1555C1H9R6CA01#					±0.25pF	GCG1552C1H2R3CA01#	
				±0.5pF	GCG1555C1H9R6DA01#					±0.5pF	GCG1552C1H2R3DA01#	
			9.7pF	±0.1pF	GCG1555C1H9R7BA01#				2.4pF	±0.1pF	GCG1552C1H2R4BA01#	
				±0.25pF	GCG1555C1H9R7CA01#					±0.25pF	GCG1552C1H2R4CA01#	
				±0.5pF	GCG1555C1H9R7DA01#					±0.5pF	GCG1552C1H2R4DA01#	
			9.8pF	±0.1pF	GCG1555C1H9R8BA01#				2.5pF	±0.1pF	GCG1552C1H2R5BA01#	
				±0.25pF	GCG1555C1H9R8CA01#					±0.25pF	GCG1552C1H2R5CA01#	
				±0.5pF	GCG1555C1H9R8DA01#					±0.5pF	GCG1552C1H2R5DA01#	
			9.9pF	±0.1pF	GCG1555C1H9R9BA01#				2.6pF	±0.1pF	GCG1552C1H2R6BA01#	

Part number # indicates the package specification code.

GRT Series
 GCM Series
 GC3 Series
 GCJ Series
 GCQ Series
 GCD Series
 GCE Series
 NMF Series
 KCM Series
 KC3 Series
 KCA Series
 GCB Series
 GCG Series
 ⚠Caution /Notice

GCG Series Temperature Compensating Type Part Number List

(→ 1.0×0.5mm)

T max.	Rated Voltage	TC Code	Cap.	Tol.	Part Number	T max.	Rated Voltage	TC Code	Cap.	Tol.	Part Number
0.55mm	50Vdc	CH	2.6pF	±0.25pF	GCG1552C1H2R6CA01#	0.55mm	50Vdc	CH	4.4pF	±0.25pF	GCG1552C1H4R4CA01#
				±0.5pF	GCG1552C1H2R6DA01#					±0.5pF	GCG1552C1H4R4DA01#
			2.7pF	±0.1pF	GCG1552C1H2R7BA01#	4.5pF			±0.1pF	GCG1552C1H4R5BA01#	
				±0.25pF	GCG1552C1H2R7CA01#				±0.25pF	GCG1552C1H4R5CA01#	
				±0.5pF	GCG1552C1H2R7DA01#				±0.5pF	GCG1552C1H4R5DA01#	
				2.8pF	±0.1pF				GCG1552C1H2R8BA01#	4.6pF	±0.1pF
			±0.25pF		GCG1552C1H2R8CA01#	±0.25pF			GCG1552C1H4R6CA01#		
			±0.5pF		GCG1552C1H2R8DA01#	±0.5pF			GCG1552C1H4R6DA01#		
			2.9pF	±0.1pF	GCG1552C1H2R9BA01#	4.7pF			±0.1pF	GCG1552C1H4R7BA01#	
				±0.25pF	GCG1552C1H2R9CA01#				±0.25pF	GCG1552C1H4R7CA01#	
				±0.5pF	GCG1552C1H2R9DA01#				±0.5pF	GCG1552C1H4R7DA01#	
			3.0pF	±0.1pF	GCG1552C1H3R0BA01#	4.8pF			±0.1pF	GCG1552C1H4R8BA01#	
				±0.25pF	GCG1552C1H3R0CA01#				±0.25pF	GCG1552C1H4R8CA01#	
				±0.5pF	GCG1552C1H3R0DA01#				±0.5pF	GCG1552C1H4R8DA01#	
			3.1pF	±0.1pF	GCG1552C1H3R1BA01#	4.9pF			±0.1pF	GCG1552C1H4R9BA01#	
				±0.25pF	GCG1552C1H3R1CA01#				±0.25pF	GCG1552C1H4R9CA01#	
				±0.5pF	GCG1552C1H3R1DA01#				±0.5pF	GCG1552C1H4R9DA01#	
			3.2pF	±0.1pF	GCG1552C1H3R2BA01#	5.0pF			±0.1pF	GCG1552C1H5R0BA01#	
				±0.25pF	GCG1552C1H3R2CA01#				±0.25pF	GCG1552C1H5R0CA01#	
				±0.5pF	GCG1552C1H3R2DA01#				±0.5pF	GCG1552C1H5R0DA01#	
			3.3pF	±0.1pF	GCG1552C1H3R3BA01#	5.1pF			±0.1pF	GCG1552C1H5R1BA01#	
				±0.25pF	GCG1552C1H3R3CA01#				±0.25pF	GCG1552C1H5R1CA01#	
				±0.5pF	GCG1552C1H3R3DA01#				±0.5pF	GCG1552C1H5R1DA01#	
			3.4pF	±0.1pF	GCG1552C1H3R4BA01#	5.2pF			±0.1pF	GCG1552C1H5R2BA01#	
				±0.25pF	GCG1552C1H3R4CA01#				±0.25pF	GCG1552C1H5R2CA01#	
				±0.5pF	GCG1552C1H3R4DA01#				±0.5pF	GCG1552C1H5R2DA01#	
			3.5pF	±0.1pF	GCG1552C1H3R5BA01#	5.3pF			±0.1pF	GCG1552C1H5R3BA01#	
				±0.25pF	GCG1552C1H3R5CA01#				±0.25pF	GCG1552C1H5R3CA01#	
				±0.5pF	GCG1552C1H3R5DA01#				±0.5pF	GCG1552C1H5R3DA01#	
			3.6pF	±0.1pF	GCG1552C1H3R6BA01#	5.4pF			±0.1pF	GCG1552C1H5R4BA01#	
				±0.25pF	GCG1552C1H3R6CA01#				±0.25pF	GCG1552C1H5R4CA01#	
				±0.5pF	GCG1552C1H3R6DA01#				±0.5pF	GCG1552C1H5R4DA01#	
			3.7pF	±0.1pF	GCG1552C1H3R7BA01#	5.5pF			±0.1pF	GCG1552C1H5R5BA01#	
				±0.25pF	GCG1552C1H3R7CA01#				±0.25pF	GCG1552C1H5R5CA01#	
				±0.5pF	GCG1552C1H3R7DA01#				±0.5pF	GCG1552C1H5R5DA01#	
			3.8pF	±0.1pF	GCG1552C1H3R8BA01#	5.6pF			±0.1pF	GCG1552C1H5R6BA01#	
				±0.25pF	GCG1552C1H3R8CA01#				±0.25pF	GCG1552C1H5R6CA01#	
				±0.5pF	GCG1552C1H3R8DA01#				±0.5pF	GCG1552C1H5R6DA01#	
			3.9pF	±0.1pF	GCG1552C1H3R9BA01#	5.7pF			±0.1pF	GCG1552C1H5R7BA01#	
				±0.25pF	GCG1552C1H3R9CA01#				±0.25pF	GCG1552C1H5R7CA01#	
				±0.5pF	GCG1552C1H3R9DA01#				±0.5pF	GCG1552C1H5R7DA01#	
			4.0pF	±0.1pF	GCG1552C1H4R0BA01#	5.8pF			±0.1pF	GCG1552C1H5R8BA01#	
				±0.25pF	GCG1552C1H4R0CA01#				±0.25pF	GCG1552C1H5R8CA01#	
				±0.5pF	GCG1552C1H4R0DA01#				±0.5pF	GCG1552C1H5R8DA01#	
			4.1pF	±0.1pF	GCG1552C1H4R1BA01#	5.9pF			±0.1pF	GCG1552C1H5R9BA01#	
				±0.25pF	GCG1552C1H4R1CA01#				±0.25pF	GCG1552C1H5R9CA01#	
				±0.5pF	GCG1552C1H4R1DA01#				±0.5pF	GCG1552C1H5R9DA01#	
			4.2pF	±0.1pF	GCG1552C1H4R2BA01#	6.0pF			±0.1pF	GCG1552C1H6R0BA01#	
±0.25pF	GCG1552C1H4R2CA01#	±0.25pF		GCG1552C1H6R0CA01#							
±0.5pF	GCG1552C1H4R2DA01#	±0.5pF		GCG1552C1H6R0DA01#							
4.3pF	±0.1pF	GCG1552C1H4R3BA01#	6.1pF	±0.1pF	GCG1552C1H6R1BA01#						
	±0.25pF	GCG1552C1H4R3CA01#		±0.25pF	GCG1552C1H6R1CA01#						
	±0.5pF	GCG1552C1H4R3DA01#		±0.5pF	GCG1552C1H6R1DA01#						
4.4pF	±0.1pF	GCG1552C1H4R4BA01#	6.2pF	±0.1pF	GCG1552C1H6R2BA01#						

Part number # indicates the package specification code.

GRT Series
 GCM Series
 GC3 Series
 GCJ Series
 GCQ Series
 GCD Series
 GCE Series
 NMF Series
 KCM Series
 KC3 Series
 KCA Series
 GCB Series
 GCG Series
 ⚠Caution /Notice

GCG Series Temperature Compensating Type Part Number List

(→ 1.0×0.5mm)

T max.	Rated Voltage	TC Code	Cap.	Tol.	Part Number	T max.	Rated Voltage	TC Code	Cap.	Tol.	Part Number
0.55mm	50Vdc	CH	6.2pF	±0.25pF	GCG1552C1H6R2CA01#	0.55mm	50Vdc	CH	8.0pF	±0.25pF	GCG1552C1H8ROCA01#
				±0.5pF	GCG1552C1H6R2DA01#					±0.5pF	GCG1552C1H8RODA01#
			6.3pF	±0.1pF	GCG1552C1H6R3BA01#	8.1pF			±0.1pF	GCG1552C1H8R1BA01#	
				±0.25pF	GCG1552C1H6R3CA01#				±0.25pF	GCG1552C1H8R1CA01#	
				±0.5pF	GCG1552C1H6R3DA01#				±0.5pF	GCG1552C1H8R1DA01#	
			6.4pF	±0.1pF	GCG1552C1H6R4BA01#	8.2pF			±0.1pF	GCG1552C1H8R2BA01#	
				±0.25pF	GCG1552C1H6R4CA01#				±0.25pF	GCG1552C1H8R2CA01#	
				±0.5pF	GCG1552C1H6R4DA01#				±0.5pF	GCG1552C1H8R2DA01#	
			6.5pF	±0.1pF	GCG1552C1H6R5BA01#	8.3pF			±0.1pF	GCG1552C1H8R3BA01#	
				±0.25pF	GCG1552C1H6R5CA01#				±0.25pF	GCG1552C1H8R3CA01#	
				±0.5pF	GCG1552C1H6R5DA01#				±0.5pF	GCG1552C1H8R3DA01#	
			6.6pF	±0.1pF	GCG1552C1H6R6BA01#	8.4pF			±0.1pF	GCG1552C1H8R4BA01#	
				±0.25pF	GCG1552C1H6R6CA01#				±0.25pF	GCG1552C1H8R4CA01#	
				±0.5pF	GCG1552C1H6R6DA01#				±0.5pF	GCG1552C1H8R4DA01#	
			6.7pF	±0.1pF	GCG1552C1H6R7BA01#	8.5pF			±0.1pF	GCG1552C1H8R5BA01#	
				±0.25pF	GCG1552C1H6R7CA01#				±0.25pF	GCG1552C1H8R5CA01#	
				±0.5pF	GCG1552C1H6R7DA01#				±0.5pF	GCG1552C1H8R5DA01#	
			6.8pF	±0.1pF	GCG1552C1H6R8BA01#	8.6pF			±0.1pF	GCG1552C1H8R6BA01#	
				±0.25pF	GCG1552C1H6R8CA01#				±0.25pF	GCG1552C1H8R6CA01#	
				±0.5pF	GCG1552C1H6R8DA01#				±0.5pF	GCG1552C1H8R6DA01#	
			6.9pF	±0.1pF	GCG1552C1H6R9BA01#	8.7pF			±0.1pF	GCG1552C1H8R7BA01#	
				±0.25pF	GCG1552C1H6R9CA01#				±0.25pF	GCG1552C1H8R7CA01#	
				±0.5pF	GCG1552C1H6R9DA01#				±0.5pF	GCG1552C1H8R7DA01#	
			7.0pF	±0.1pF	GCG1552C1H7R0BA01#	8.8pF			±0.1pF	GCG1552C1H8R8BA01#	
				±0.25pF	GCG1552C1H7R0CA01#				±0.25pF	GCG1552C1H8R8CA01#	
				±0.5pF	GCG1552C1H7R0DA01#				±0.5pF	GCG1552C1H8R8DA01#	
			7.1pF	±0.1pF	GCG1552C1H7R1BA01#	8.9pF			±0.1pF	GCG1552C1H8R9BA01#	
				±0.25pF	GCG1552C1H7R1CA01#				±0.25pF	GCG1552C1H8R9CA01#	
				±0.5pF	GCG1552C1H7R1DA01#				±0.5pF	GCG1552C1H8R9DA01#	
			7.2pF	±0.1pF	GCG1552C1H7R2BA01#	9.0pF			±0.1pF	GCG1552C1H9R0BA01#	
				±0.25pF	GCG1552C1H7R2CA01#				±0.25pF	GCG1552C1H9R0CA01#	
				±0.5pF	GCG1552C1H7R2DA01#				±0.5pF	GCG1552C1H9R0DA01#	
			7.3pF	±0.1pF	GCG1552C1H7R3BA01#	9.1pF			±0.1pF	GCG1552C1H9R1BA01#	
				±0.25pF	GCG1552C1H7R3CA01#				±0.25pF	GCG1552C1H9R1CA01#	
				±0.5pF	GCG1552C1H7R3DA01#				±0.5pF	GCG1552C1H9R1DA01#	
			7.4pF	±0.1pF	GCG1552C1H7R4BA01#	9.2pF			±0.1pF	GCG1552C1H9R2BA01#	
				±0.25pF	GCG1552C1H7R4CA01#				±0.25pF	GCG1552C1H9R2CA01#	
				±0.5pF	GCG1552C1H7R4DA01#				±0.5pF	GCG1552C1H9R2DA01#	
			7.5pF	±0.1pF	GCG1552C1H7R5BA01#	9.3pF			±0.1pF	GCG1552C1H9R3BA01#	
				±0.25pF	GCG1552C1H7R5CA01#				±0.25pF	GCG1552C1H9R3CA01#	
				±0.5pF	GCG1552C1H7R5DA01#				±0.5pF	GCG1552C1H9R3DA01#	
			7.6pF	±0.1pF	GCG1552C1H7R6BA01#	9.4pF			±0.1pF	GCG1552C1H9R4BA01#	
				±0.25pF	GCG1552C1H7R6CA01#				±0.25pF	GCG1552C1H9R4CA01#	
				±0.5pF	GCG1552C1H7R6DA01#				±0.5pF	GCG1552C1H9R4DA01#	
			7.7pF	±0.1pF	GCG1552C1H7R7BA01#	9.5pF			±0.1pF	GCG1552C1H9R5BA01#	
				±0.25pF	GCG1552C1H7R7CA01#				±0.25pF	GCG1552C1H9R5CA01#	
				±0.5pF	GCG1552C1H7R7DA01#				±0.5pF	GCG1552C1H9R5DA01#	
			7.8pF	±0.1pF	GCG1552C1H7R8BA01#	9.6pF			±0.1pF	GCG1552C1H9R6BA01#	
±0.25pF	GCG1552C1H7R8CA01#	±0.25pF		GCG1552C1H9R6CA01#							
±0.5pF	GCG1552C1H7R8DA01#	±0.5pF		GCG1552C1H9R6DA01#							
7.9pF	±0.1pF	GCG1552C1H7R9BA01#	9.7pF	±0.1pF	GCG1552C1H9R7BA01#						
	±0.25pF	GCG1552C1H7R9CA01#		±0.25pF	GCG1552C1H9R7CA01#						
	±0.5pF	GCG1552C1H7R9DA01#		±0.5pF	GCG1552C1H9R7DA01#						
8.0pF	±0.1pF	GCG1552C1H8R0BA01#	9.8pF	±0.1pF	GCG1552C1H9R8BA01#						

Part number # indicates the package specification code.

GRT Series
 GCM Series
 GC3 Series
 GCJ Series
 GCQ Series
 GCD Series
 GCE Series
 NMF Series
 KCM Series
 KC3 Series
 KCA Series
 GCB Series
 GCG Series
 ⚠Caution /Notice

GCG Series Temperature Compensating Type Part Number List

(→ 1.0×0.5mm)

T max.	Rated Voltage	TC Code	Cap.	Tol.	Part Number	T max.	Rated Voltage	TC Code	Cap.	Tol.	Part Number
0.55mm	50Vdc	CHA	1.3pF	±0.25pF	GCG1550C1H1R3CA01#	0.55mm	50Vdc	CHA	3.1pF	±0.25pF	GCG1550C1H3R1CA01#
				±0.5pF	GCG1550C1H1R3DA01#					±0.5pF	GCG1550C1H3R1DA01#
			1.4pF	±0.1pF	GCG1550C1H1R4BA01#	3.2pF			±0.1pF	GCG1550C1H3R2BA01#	
				±0.25pF	GCG1550C1H1R4CA01#				±0.25pF	GCG1550C1H3R2CA01#	
			1.5pF	±0.5pF	GCG1550C1H1R4DA01#	3.3pF			±0.5pF	GCG1550C1H3R2DA01#	
				±0.1pF	GCG1550C1H1R5BA01#				±0.1pF	GCG1550C1H3R3BA01#	
			1.6pF	±0.25pF	GCG1550C1H1R5CA01#	3.4pF			±0.25pF	GCG1550C1H3R3CA01#	
				±0.5pF	GCG1550C1H1R5DA01#				±0.5pF	GCG1550C1H3R3DA01#	
			1.7pF	±0.1pF	GCG1550C1H1R6BA01#	3.5pF			±0.1pF	GCG1550C1H3R4BA01#	
				±0.25pF	GCG1550C1H1R6CA01#				±0.25pF	GCG1550C1H3R4CA01#	
			1.8pF	±0.5pF	GCG1550C1H1R6DA01#	3.6pF			±0.5pF	GCG1550C1H3R4DA01#	
				±0.1pF	GCG1550C1H1R7BA01#				±0.1pF	GCG1550C1H3R5BA01#	
			1.9pF	±0.25pF	GCG1550C1H1R7CA01#	3.7pF			±0.25pF	GCG1550C1H3R5CA01#	
				±0.5pF	GCG1550C1H1R7DA01#				±0.5pF	GCG1550C1H3R5DA01#	
			2.0pF	±0.1pF	GCG1550C1H1R8BA01#	3.8pF			±0.1pF	GCG1550C1H3R6BA01#	
				±0.25pF	GCG1550C1H1R8CA01#				±0.25pF	GCG1550C1H3R6CA01#	
			2.1pF	±0.5pF	GCG1550C1H1R8DA01#	3.9pF			±0.5pF	GCG1550C1H3R6DA01#	
				±0.1pF	GCG1550C1H1R9BA01#				±0.1pF	GCG1550C1H3R7BA01#	
			2.2pF	±0.25pF	GCG1550C1H1R9CA01#	4.0pF			±0.25pF	GCG1550C1H3R7CA01#	
				±0.5pF	GCG1550C1H1R9DA01#				±0.5pF	GCG1550C1H3R7DA01#	
			2.3pF	±0.1pF	GCG1550C1H2R0BA01#	4.1pF			±0.1pF	GCG1550C1H3R8BA01#	
				±0.25pF	GCG1550C1H2R0CA01#				±0.25pF	GCG1550C1H3R8CA01#	
			2.4pF	±0.5pF	GCG1550C1H2R0DA01#	4.2pF			±0.5pF	GCG1550C1H3R8DA01#	
				±0.1pF	GCG1550C1H2R1BA01#				±0.1pF	GCG1550C1H3R9BA01#	
			2.5pF	±0.25pF	GCG1550C1H2R1CA01#	4.3pF			±0.25pF	GCG1550C1H3R9CA01#	
				±0.5pF	GCG1550C1H2R1DA01#				±0.5pF	GCG1550C1H3R9DA01#	
			2.6pF	±0.1pF	GCG1550C1H2R2BA01#	4.4pF			±0.1pF	GCG1550C1H4R0BA01#	
				±0.25pF	GCG1550C1H2R2CA01#				±0.25pF	GCG1550C1H4R0CA01#	
			2.7pF	±0.5pF	GCG1550C1H2R2DA01#	4.5pF			±0.5pF	GCG1550C1H4R0DA01#	
				±0.1pF	GCG1550C1H2R3BA01#				±0.1pF	GCG1550C1H4R1BA01#	
			2.8pF	±0.25pF	GCG1550C1H2R3CA01#	4.6pF			±0.25pF	GCG1550C1H4R1CA01#	
				±0.5pF	GCG1550C1H2R3DA01#				±0.5pF	GCG1550C1H4R1DA01#	
			2.9pF	±0.1pF	GCG1550C1H2R4BA01#	4.7pF			±0.1pF	GCG1550C1H4R2BA01#	
				±0.25pF	GCG1550C1H2R4CA01#				±0.25pF	GCG1550C1H4R2CA01#	
			3.0pF	±0.5pF	GCG1550C1H2R4DA01#	4.8pF			±0.5pF	GCG1550C1H4R2DA01#	
				±0.1pF	GCG1550C1H2R5BA01#				±0.1pF	GCG1550C1H4R3BA01#	
			3.1pF	±0.25pF	GCG1550C1H2R5CA01#	4.9pF			±0.25pF	GCG1550C1H4R3CA01#	
				±0.5pF	GCG1550C1H2R5DA01#				±0.5pF	GCG1550C1H4R3DA01#	

Part number # indicates the package specification code.

GRT Series
 GCM Series
 GC3 Series
 GCJ Series
 GCQ Series
 GCD Series
 GCE Series
 NMF Series
 KCM Series
 KC3 Series
 KCA Series
 GCB Series
 GCG Series
 ⚠Caution /Notice

GCG Series Temperature Compensating Type Part Number List

(→ 1.0×0.5mm)

T max.	Rated Voltage	TC Code	Cap.	Tol.	Part Number	T max.	Rated Voltage	TC Code	Cap.	Tol.	Part Number
0.55mm	50Vdc	CHA	4.9pF	±0.25pF	GCG1550C1H4R9CA01#	0.55mm	50Vdc	CHA	6.7pF	±0.25pF	GCG1550C1H6R7CA01#
				±0.5pF	GCG1550C1H4R9DA01#					±0.5pF	GCG1550C1H6R7DA01#
				5.0pF	±0.1pF					GCG1550C1H5R0BA01#	6.8pF
			±0.25pF		GCG1550C1H5R0CA01#				±0.25pF	GCG1550C1H6R8CA01#	
			±0.5pF		GCG1550C1H5R0DA01#				±0.5pF	GCG1550C1H6R8DA01#	
			5.1pF	±0.1pF	GCG1550C1H5R1BA01#				6.9pF	±0.1pF	GCG1550C1H6R9BA01#
				±0.25pF	GCG1550C1H5R1CA01#					±0.25pF	GCG1550C1H6R9CA01#
				±0.5pF	GCG1550C1H5R1DA01#					±0.5pF	GCG1550C1H6R9DA01#
			5.2pF	±0.1pF	GCG1550C1H5R2BA01#				7.0pF	±0.1pF	GCG1550C1H7R0BA01#
				±0.25pF	GCG1550C1H5R2CA01#					±0.25pF	GCG1550C1H7R0CA01#
				±0.5pF	GCG1550C1H5R2DA01#					±0.5pF	GCG1550C1H7R0DA01#
			5.3pF	±0.1pF	GCG1550C1H5R3BA01#				7.1pF	±0.1pF	GCG1550C1H7R1BA01#
				±0.25pF	GCG1550C1H5R3CA01#					±0.25pF	GCG1550C1H7R1CA01#
				±0.5pF	GCG1550C1H5R3DA01#					±0.5pF	GCG1550C1H7R1DA01#
			5.4pF	±0.1pF	GCG1550C1H5R4BA01#				7.2pF	±0.1pF	GCG1550C1H7R2BA01#
				±0.25pF	GCG1550C1H5R4CA01#					±0.25pF	GCG1550C1H7R2CA01#
				±0.5pF	GCG1550C1H5R4DA01#					±0.5pF	GCG1550C1H7R2DA01#
			5.5pF	±0.1pF	GCG1550C1H5R5BA01#				7.3pF	±0.1pF	GCG1550C1H7R3BA01#
				±0.25pF	GCG1550C1H5R5CA01#					±0.25pF	GCG1550C1H7R3CA01#
				±0.5pF	GCG1550C1H5R5DA01#					±0.5pF	GCG1550C1H7R3DA01#
			5.6pF	±0.1pF	GCG1550C1H5R6BA01#				7.4pF	±0.1pF	GCG1550C1H7R4BA01#
				±0.25pF	GCG1550C1H5R6CA01#					±0.25pF	GCG1550C1H7R4CA01#
				±0.5pF	GCG1550C1H5R6DA01#					±0.5pF	GCG1550C1H7R4DA01#
			5.7pF	±0.1pF	GCG1550C1H5R7BA01#				7.5pF	±0.1pF	GCG1550C1H7R5BA01#
				±0.25pF	GCG1550C1H5R7CA01#					±0.25pF	GCG1550C1H7R5CA01#
				±0.5pF	GCG1550C1H5R7DA01#					±0.5pF	GCG1550C1H7R5DA01#
			5.8pF	±0.1pF	GCG1550C1H5R8BA01#				7.6pF	±0.1pF	GCG1550C1H7R6BA01#
				±0.25pF	GCG1550C1H5R8CA01#					±0.25pF	GCG1550C1H7R6CA01#
				±0.5pF	GCG1550C1H5R8DA01#					±0.5pF	GCG1550C1H7R6DA01#
			5.9pF	±0.1pF	GCG1550C1H5R9BA01#				7.7pF	±0.1pF	GCG1550C1H7R7BA01#
				±0.25pF	GCG1550C1H5R9CA01#					±0.25pF	GCG1550C1H7R7CA01#
				±0.5pF	GCG1550C1H5R9DA01#					±0.5pF	GCG1550C1H7R7DA01#
			6.0pF	±0.1pF	GCG1550C1H6R0BA01#				7.8pF	±0.1pF	GCG1550C1H7R8BA01#
				±0.25pF	GCG1550C1H6R0CA01#					±0.25pF	GCG1550C1H7R8CA01#
				±0.5pF	GCG1550C1H6R0DA01#					±0.5pF	GCG1550C1H7R8DA01#
			6.1pF	±0.1pF	GCG1550C1H6R1BA01#				7.9pF	±0.1pF	GCG1550C1H7R9BA01#
				±0.25pF	GCG1550C1H6R1CA01#					±0.25pF	GCG1550C1H7R9CA01#
				±0.5pF	GCG1550C1H6R1DA01#					±0.5pF	GCG1550C1H7R9DA01#
			6.2pF	±0.1pF	GCG1550C1H6R2BA01#				8.0pF	±0.1pF	GCG1550C1H8R0BA01#
				±0.25pF	GCG1550C1H6R2CA01#					±0.25pF	GCG1550C1H8R0CA01#
				±0.5pF	GCG1550C1H6R2DA01#					±0.5pF	GCG1550C1H8R0DA01#
			6.3pF	±0.1pF	GCG1550C1H6R3BA01#				8.1pF	±0.1pF	GCG1550C1H8R1BA01#
±0.25pF	GCG1550C1H6R3CA01#	±0.25pF		GCG1550C1H8R1CA01#							
±0.5pF	GCG1550C1H6R3DA01#	±0.5pF		GCG1550C1H8R1DA01#							
6.4pF	±0.1pF	GCG1550C1H6R4BA01#	8.2pF	±0.1pF	GCG1550C1H8R2BA01#						
	±0.25pF	GCG1550C1H6R4CA01#		±0.25pF	GCG1550C1H8R2CA01#						
	±0.5pF	GCG1550C1H6R4DA01#		±0.5pF	GCG1550C1H8R2DA01#						
6.5pF	±0.1pF	GCG1550C1H6R5BA01#	8.3pF	±0.1pF	GCG1550C1H8R3BA01#						
	±0.25pF	GCG1550C1H6R5CA01#		±0.25pF	GCG1550C1H8R3CA01#						
	±0.5pF	GCG1550C1H6R5DA01#		±0.5pF	GCG1550C1H8R3DA01#						
6.6pF	±0.1pF	GCG1550C1H6R6BA01#	8.4pF	±0.1pF	GCG1550C1H8R4BA01#						
	±0.25pF	GCG1550C1H6R6CA01#		±0.25pF	GCG1550C1H8R4CA01#						
	±0.5pF	GCG1550C1H6R6DA01#		±0.5pF	GCG1550C1H8R4DA01#						
6.7pF	±0.1pF	GCG1550C1H6R7BA01#	8.5pF	±0.1pF	GCG1550C1H8R5BA01#						

Part number # indicates the package specification code.

GRT Series
 GCM Series
 GC3 Series
 GCJ Series
 GCQ Series
 GCD Series
 GCE Series
 NMF Series
 KCM Series
 KC3 Series
 KCA Series
 GCB Series
 GCG Series
 ⚠Caution /Notice

GCG Series Temperature Compensating Type **Power-train** **AEC-Q200** **Deflecting crack** **Soldering crack** **Limited to conductive glue mounting** Part Number List

(→ 1.0×0.5mm)

T max.	Rated Voltage	TC Code	Cap.	Tol.	Part Number	T max.	Rated Voltage	TC Code	Cap.	Tol.	Part Number	
0.55mm	50Vdc	CHA	8.5pF	±0.25pF	GCG1550C1H8R5CA01#	0.55mm	50Vdc	CHA	15pF	±5%	GCG1550C1H150JA01#	
				±0.5pF	GCG1550C1H8R5DA01#					16pF	±2%	GCG1550C1H160GA01#
				±0.1pF	GCG1550C1H8R6BA01#						±5%	GCG1550C1H160JA01#
			±0.25pF	GCG1550C1H8R6CA01#	18pF				±2%	GCG1550C1H180GA01#		
			±0.5pF	GCG1550C1H8R6DA01#					±5%	GCG1550C1H180JA01#		
			8.6pF	±0.1pF	GCG1550C1H8R7BA01#				20pF	±2%	GCG1550C1H200GA01#	
				±0.25pF	GCG1550C1H8R7CA01#					±5%	GCG1550C1H200JA01#	
				±0.5pF	GCG1550C1H8R7DA01#				22pF	±2%	GCG1550C1H220GA01#	
			8.7pF	±0.1pF	GCG1550C1H8R8BA01#					±5%	GCG1550C1H220JA01#	
				±0.25pF	GCG1550C1H8R8CA01#				24pF	±2%	GCG1550C1H240GA01#	
				±0.5pF	GCG1550C1H8R8DA01#					±5%	GCG1550C1H240JA01#	
			8.8pF	±0.1pF	GCG1550C1H8R9BA01#				27pF	±2%	GCG1550C1H270GA01#	
				±0.25pF	GCG1550C1H8R9CA01#					±5%	GCG1550C1H270JA01#	
				±0.5pF	GCG1550C1H8R9DA01#				30pF	±2%	GCG1550C1H300GA01#	
			8.9pF	±0.1pF	GCG1550C1H9R0BA01#					±5%	GCG1550C1H300JA01#	
				±0.25pF	GCG1550C1H9R0CA01#				33pF	±2%	GCG1550C1H330GA01#	
				±0.5pF	GCG1550C1H9R0DA01#					±5%	GCG1550C1H330JA01#	
			9.0pF	±0.1pF	GCG1550C1H9R1BA01#				36pF	±2%	GCG1550C1H360GA01#	
				±0.25pF	GCG1550C1H9R1CA01#					±5%	GCG1550C1H360JA01#	
				±0.5pF	GCG1550C1H9R1DA01#				39pF	±2%	GCG1550C1H390GA01#	
			9.1pF	±0.1pF	GCG1550C1H9R2BA01#					±5%	GCG1550C1H390JA01#	
				±0.25pF	GCG1550C1H9R2CA01#				43pF	±2%	GCG1550C1H430GA01#	
				±0.5pF	GCG1550C1H9R2DA01#					±5%	GCG1550C1H430JA01#	
			9.2pF	±0.1pF	GCG1550C1H9R3BA01#				47pF	±2%	GCG1550C1H470GA01#	
				±0.25pF	GCG1550C1H9R3CA01#					±5%	GCG1550C1H470JA01#	
				±0.5pF	GCG1550C1H9R3DA01#				51pF	±2%	GCG1550C1H510GA01#	
			9.3pF	±0.1pF	GCG1550C1H9R4BA01#					±5%	GCG1550C1H510JA01#	
				±0.25pF	GCG1550C1H9R4CA01#				56pF	±2%	GCG1550C1H560GA01#	
				±0.5pF	GCG1550C1H9R4DA01#					±5%	GCG1550C1H560JA01#	
			9.4pF	±0.1pF	GCG1550C1H9R5BA01#				62pF	±2%	GCG1550C1H620GA01#	
				±0.25pF	GCG1550C1H9R5CA01#					±5%	GCG1550C1H620JA01#	
				±0.5pF	GCG1550C1H9R5DA01#				68pF	±2%	GCG1550C1H680GA01#	
			9.5pF	±0.1pF	GCG1550C1H9R6BA01#					±5%	GCG1550C1H680JA01#	
				±0.25pF	GCG1550C1H9R6CA01#				75pF	±2%	GCG1550C1H750GA01#	
				±0.5pF	GCG1550C1H9R6DA01#					±5%	GCG1550C1H750JA01#	
			9.6pF	±0.1pF	GCG1550C1H9R7BA01#				82pF	±2%	GCG1550C1H820GA01#	
				±0.25pF	GCG1550C1H9R7CA01#					±5%	GCG1550C1H820JA01#	
				±0.5pF	GCG1550C1H9R7DA01#				91pF	±2%	GCG1550C1H910GA01#	
			9.7pF	±0.1pF	GCG1550C1H9R8BA01#					±5%	GCG1550C1H910JA01#	
				±0.25pF	GCG1550C1H9R8CA01#				100pF	±2%	GCG1550C1H101GA01#	
				±0.5pF	GCG1550C1H9R8DA01#					±5%	GCG1550C1H101JA01#	
			9.8pF	±0.1pF	GCG1550C1H9R9BA01#				1.0pF	±0.1pF	GCG1555G1H1R0BA01#	
				±0.25pF	GCG1550C1H9R9CA01#					±0.25pF	GCG1555G1H1R0CA01#	
				±0.5pF	GCG1550C1H9R9DA01#				±0.5pF	GCG1555G1H1R0DA01#		
			9.9pF	±1%	GCG1550C1H100FA01#				1.1pF	±0.1pF	GCG1555G1H1R1BA01#	
				±2.5%	GCG1550C1H100RA01#					±0.25pF	GCG1555G1H1R1CA01#	
				±5%	GCG1550C1H100JA01#					±0.5pF	GCG1555G1H1R1DA01#	
			10pF	±2%	GCG1550C1H110GA01#				1.2pF	±0.1pF	GCG1555G1H1R2BA01#	
				±5%	GCG1550C1H110JA01#					±0.25pF	GCG1555G1H1R2CA01#	
			11pF	±2%	GCG1550C1H120GA01#				1.3pF	±0.5pF	GCG1555G1H1R2DA01#	
				±5%	GCG1550C1H120JA01#					±0.1pF	GCG1555G1H1R3BA01#	
			12pF	±2%	GCG1550C1H130GA01#				1.4pF	±0.25pF	GCG1555G1H1R3CA01#	
				±5%	GCG1550C1H130JA01#					±0.5pF	GCG1555G1H1R3DA01#	
			13pF	±2%	GCG1550C1H150GA01#							
±5%	GCG1550C1H150JA01#											

GRT Series
 GCM Series
 GC3 Series
 GCJ Series
 GCQ Series
 GCD Series
 GCE Series
 NMF Series
 KCM Series
 KC3 Series
 KCA Series
 GCB Series
 GCG Series
 ⚠Caution /Notice

Part number # indicates the package specification code.

GCG Series Temperature Compensating Type Part Number List

(→ 1.0×0.5mm)

T max.	Rated Voltage	TC Code	Cap.	Tol.	Part Number	T max.	Rated Voltage	TC Code	Cap.	Tol.	Part Number
0.55mm	50Vdc	X8G	1.4pF	±0.25pF	GCG1555G1H1R4CA01#	0.55mm	50Vdc	X8G	3.2pF	±0.25pF	GCG1555G1H3R2CA01#
				±0.5pF	GCG1555G1H1R4DA01#					±0.5pF	GCG1555G1H3R2DA01#
			1.5pF	±0.1pF	GCG1555G1H1R5BA01#	3.3pF			±0.1pF	GCG1555G1H3R3BA01#	
				±0.25pF	GCG1555G1H1R5CA01#				±0.25pF	GCG1555G1H3R3CA01#	
			±0.5pF	GCG1555G1H1R5DA01#	3.4pF	±0.1pF			GCG1555G1H3R4BA01#		
				GCG1555G1H1R6BA01#		±0.25pF			GCG1555G1H3R4CA01#		
			±0.25pF	GCG1555G1H1R6CA01#	3.5pF	±0.1pF			GCG1555G1H3R5BA01#		
				GCG1555G1H1R6DA01#		±0.25pF			GCG1555G1H3R5CA01#		
			±0.5pF	GCG1555G1H1R7BA01#	3.6pF	±0.1pF			GCG1555G1H3R6BA01#		
				GCG1555G1H1R7CA01#		±0.25pF			GCG1555G1H3R6CA01#		
			±0.25pF	GCG1555G1H1R7DA01#	3.7pF	±0.1pF			GCG1555G1H3R7BA01#		
				GCG1555G1H1R8BA01#		±0.25pF			GCG1555G1H3R7CA01#		
			±0.5pF	GCG1555G1H1R8CA01#	3.8pF	±0.1pF			GCG1555G1H3R8BA01#		
				GCG1555G1H1R8DA01#		±0.25pF			GCG1555G1H3R8CA01#		
			±0.5pF	GCG1555G1H1R9BA01#	3.9pF	±0.1pF			GCG1555G1H3R9BA01#		
				GCG1555G1H1R9CA01#		±0.25pF			GCG1555G1H3R9CA01#		
			±0.5pF	GCG1555G1H1R9DA01#	4.0pF	±0.1pF			GCG1555G1H4R0BA01#		
				GCG1555G1H2R0BA01#		±0.25pF			GCG1555G1H4R0CA01#		
			±0.25pF	GCG1555G1H2R0CA01#	4.1pF	±0.1pF			GCG1555G1H4R1BA01#		
				GCG1555G1H2R0DA01#		±0.25pF			GCG1555G1H4R1CA01#		
			±0.5pF	GCG1555G1H2R1BA01#	4.2pF	±0.1pF			GCG1555G1H4R2BA01#		
				GCG1555G1H2R1CA01#		±0.25pF			GCG1555G1H4R2CA01#		
			±0.5pF	GCG1555G1H2R1DA01#	4.3pF	±0.1pF			GCG1555G1H4R3BA01#		
				GCG1555G1H2R2BA01#		±0.25pF			GCG1555G1H4R3CA01#		
			±0.25pF	GCG1555G1H2R2CA01#	4.4pF	±0.1pF			GCG1555G1H4R4BA01#		
				GCG1555G1H2R2DA01#		±0.25pF			GCG1555G1H4R4CA01#		
			±0.5pF	GCG1555G1H2R3BA01#	4.5pF	±0.1pF			GCG1555G1H4R5BA01#		
				GCG1555G1H2R3CA01#		±0.25pF			GCG1555G1H4R5CA01#		
			±0.5pF	GCG1555G1H2R3DA01#	4.6pF	±0.1pF			GCG1555G1H4R6BA01#		
				GCG1555G1H2R4BA01#		±0.25pF			GCG1555G1H4R6CA01#		
			±0.25pF	GCG1555G1H2R4CA01#	4.7pF	±0.1pF			GCG1555G1H4R7BA01#		
				GCG1555G1H2R4DA01#		±0.25pF			GCG1555G1H4R7CA01#		
			±0.5pF	GCG1555G1H2R5BA01#	4.8pF	±0.1pF			GCG1555G1H4R8BA01#		
				GCG1555G1H2R5CA01#		±0.25pF			GCG1555G1H4R8CA01#		
			±0.5pF	GCG1555G1H2R5DA01#	4.9pF	±0.1pF			GCG1555G1H4R9BA01#		
				GCG1555G1H2R6BA01#		±0.25pF			GCG1555G1H4R9CA01#		
			±0.25pF	GCG1555G1H2R6CA01#	5.0pF	±0.1pF			GCG1555G1H5R0BA01#		
				GCG1555G1H2R6DA01#		±0.25pF					
			±0.5pF	GCG1555G1H2R7BA01#							
				GCG1555G1H2R7CA01#							
			±0.5pF	GCG1555G1H2R7DA01#							
				GCG1555G1H2R8BA01#							
			±0.25pF	GCG1555G1H2R8CA01#							
				GCG1555G1H2R8DA01#							
			±0.5pF	GCG1555G1H2R8DA01#							
				GCG1555G1H2R9BA01#							
			±0.25pF	GCG1555G1H2R9CA01#							
				GCG1555G1H2R9DA01#							
±0.5pF	GCG1555G1H2R9DA01#										
	GCG1555G1H3R0BA01#										
±0.25pF	GCG1555G1H3R0CA01#										
	GCG1555G1H3R0DA01#										
±0.5pF	GCG1555G1H3R0DA01#										
	GCG1555G1H3R1BA01#										
±0.25pF	GCG1555G1H3R1CA01#										
	GCG1555G1H3R1DA01#										
±0.5pF	GCG1555G1H3R1DA01#										
	GCG1555G1H3R2BA01#										

Part number # indicates the package specification code.

GRT Series
 GCM Series
 GC3 Series
 GCJ Series
 GCQ Series
 GCD Series
 GCE Series
 NMF Series
 KCM Series
 KC3 Series
 KCA Series
 GCB Series
 GCG Series
 ⚠Caution /Notice

GCG Series Temperature Compensating Type Part Number List

(→ 1.0×0.5mm)

T max.	Rated Voltage	TC Code	Cap.	Tol.	Part Number	T max.	Rated Voltage	TC Code	Cap.	Tol.	Part Number
0.55mm	50Vdc	X8G	5.0pF	±0.25pF	GCG1555G1H5R0CA01#	0.55mm	50Vdc	X8G	6.8pF	±0.25pF	GCG1555G1H6R8CA01#
				±0.5pF	GCG1555G1H5R0DA01#					±0.5pF	GCG1555G1H6R8DA01#
			5.1pF	±0.1pF	GCG1555G1H5R1BA01#				6.9pF	±0.1pF	GCG1555G1H6R9BA01#
				±0.25pF	GCG1555G1H5R1CA01#					±0.25pF	GCG1555G1H6R9CA01#
			5.2pF	±0.5pF	GCG1555G1H5R1DA01#				7.0pF	±0.5pF	GCG1555G1H6R9DA01#
				±0.1pF	GCG1555G1H5R2BA01#					±0.1pF	GCG1555G1H7R0BA01#
			5.3pF	±0.25pF	GCG1555G1H5R2CA01#				7.1pF	±0.25pF	GCG1555G1H7R0CA01#
				±0.5pF	GCG1555G1H5R2DA01#					±0.5pF	GCG1555G1H7R0DA01#
			5.4pF	±0.1pF	GCG1555G1H5R3BA01#				7.2pF	±0.1pF	GCG1555G1H7R1BA01#
				±0.25pF	GCG1555G1H5R3CA01#					±0.25pF	GCG1555G1H7R1CA01#
			5.5pF	±0.5pF	GCG1555G1H5R3DA01#				7.3pF	±0.5pF	GCG1555G1H7R1DA01#
				±0.1pF	GCG1555G1H5R4BA01#					±0.1pF	GCG1555G1H7R2BA01#
			5.6pF	±0.25pF	GCG1555G1H5R4CA01#				7.4pF	±0.25pF	GCG1555G1H7R2CA01#
				±0.5pF	GCG1555G1H5R4DA01#					±0.5pF	GCG1555G1H7R2DA01#
			5.7pF	±0.1pF	GCG1555G1H5R5BA01#				7.5pF	±0.1pF	GCG1555G1H7R3BA01#
				±0.25pF	GCG1555G1H5R5CA01#					±0.25pF	GCG1555G1H7R3CA01#
			5.8pF	±0.5pF	GCG1555G1H5R5DA01#				7.6pF	±0.5pF	GCG1555G1H7R3DA01#
				±0.1pF	GCG1555G1H5R6BA01#					±0.1pF	GCG1555G1H7R4BA01#
			5.9pF	±0.25pF	GCG1555G1H5R6CA01#				7.7pF	±0.25pF	GCG1555G1H7R4CA01#
				±0.5pF	GCG1555G1H5R6DA01#					±0.5pF	GCG1555G1H7R4DA01#
			6.0pF	±0.1pF	GCG1555G1H5R7BA01#				7.8pF	±0.1pF	GCG1555G1H7R5BA01#
				±0.25pF	GCG1555G1H5R7CA01#					±0.25pF	GCG1555G1H7R5CA01#
			6.1pF	±0.5pF	GCG1555G1H5R7DA01#				7.9pF	±0.5pF	GCG1555G1H7R5DA01#
				±0.1pF	GCG1555G1H5R8BA01#					±0.1pF	GCG1555G1H7R6BA01#
			6.2pF	±0.25pF	GCG1555G1H5R8CA01#				8.0pF	±0.25pF	GCG1555G1H7R6CA01#
				±0.5pF	GCG1555G1H5R8DA01#					±0.5pF	GCG1555G1H7R6DA01#
			6.3pF	±0.1pF	GCG1555G1H5R9BA01#				8.1pF	±0.1pF	GCG1555G1H7R7BA01#
				±0.25pF	GCG1555G1H5R9CA01#					±0.25pF	GCG1555G1H7R7CA01#
			6.4pF	±0.5pF	GCG1555G1H5R9DA01#				8.2pF	±0.5pF	GCG1555G1H7R7DA01#
				±0.1pF	GCG1555G1H6R0BA01#					±0.1pF	GCG1555G1H7R8BA01#
			6.5pF	±0.25pF	GCG1555G1H6R0CA01#				8.3pF	±0.25pF	GCG1555G1H7R8CA01#
				±0.5pF	GCG1555G1H6R0DA01#					±0.5pF	GCG1555G1H7R8DA01#
			6.6pF	±0.1pF	GCG1555G1H6R1BA01#				8.4pF	±0.1pF	GCG1555G1H7R9BA01#
				±0.25pF	GCG1555G1H6R1CA01#					±0.25pF	GCG1555G1H7R9CA01#
			6.7pF	±0.5pF	GCG1555G1H6R1DA01#				8.5pF	±0.5pF	GCG1555G1H7R9DA01#
				±0.1pF	GCG1555G1H6R2BA01#					±0.1pF	GCG1555G1H8R0BA01#
			6.8pF	±0.25pF	GCG1555G1H6R2CA01#				8.6pF	±0.25pF	GCG1555G1H8R0CA01#
				±0.5pF	GCG1555G1H6R2DA01#					±0.5pF	GCG1555G1H8R0DA01#
			6.9pF	±0.1pF	GCG1555G1H6R3BA01#				8.7pF	±0.1pF	GCG1555G1H8R1BA01#
				±0.25pF	GCG1555G1H6R3CA01#					±0.25pF	GCG1555G1H8R1CA01#
			7.0pF	±0.5pF	GCG1555G1H6R3DA01#				8.8pF	±0.5pF	GCG1555G1H8R1DA01#
				±0.1pF	GCG1555G1H6R4BA01#					±0.1pF	GCG1555G1H8R2BA01#
			7.1pF	±0.25pF	GCG1555G1H6R4CA01#				8.9pF	±0.25pF	GCG1555G1H8R2CA01#
				±0.5pF	GCG1555G1H6R4DA01#					±0.5pF	GCG1555G1H8R2DA01#
			7.2pF	±0.1pF	GCG1555G1H6R5BA01#				9.0pF	±0.1pF	GCG1555G1H8R3BA01#
				±0.25pF	GCG1555G1H6R5CA01#					±0.25pF	GCG1555G1H8R3CA01#
			7.3pF	±0.5pF	GCG1555G1H6R5DA01#				9.1pF	±0.5pF	GCG1555G1H8R3DA01#
				±0.1pF	GCG1555G1H6R6BA01#					±0.1pF	GCG1555G1H8R4BA01#
7.4pF	±0.25pF	GCG1555G1H6R6CA01#	9.2pF	±0.25pF	GCG1555G1H8R4CA01#						
	±0.5pF	GCG1555G1H6R6DA01#		±0.5pF	GCG1555G1H8R4DA01#						
7.5pF	±0.1pF	GCG1555G1H6R7BA01#	9.3pF	±0.1pF	GCG1555G1H8R5BA01#						
	±0.25pF	GCG1555G1H6R7CA01#		±0.25pF	GCG1555G1H8R5CA01#						
7.6pF	±0.5pF	GCG1555G1H6R7DA01#	9.4pF	±0.5pF	GCG1555G1H8R5DA01#						
	±0.1pF	GCG1555G1H6R8BA01#		±0.1pF	GCG1555G1H8R6BA01#						
7.7pF	±0.25pF	GCG1555G1H6R8CA01#	9.5pF	±0.25pF	GCG1555G1H8R6CA01#						
	±0.5pF	GCG1555G1H6R8DA01#		±0.5pF	GCG1555G1H8R6DA01#						
7.8pF	±0.1pF	GCG1555G1H6R9BA01#	9.6pF	±0.1pF	GCG1555G1H8R7BA01#						
	±0.25pF	GCG1555G1H6R9CA01#		±0.25pF	GCG1555G1H8R7CA01#						
7.9pF	±0.5pF	GCG1555G1H6R9DA01#	9.7pF	±0.5pF	GCG1555G1H8R7DA01#						
	±0.1pF	GCG1555G1H7R0BA01#		±0.1pF	GCG1555G1H8R8BA01#						
8.0pF	±0.25pF	GCG1555G1H7R0CA01#	9.8pF	±0.25pF	GCG1555G1H8R8CA01#						
	±0.5pF	GCG1555G1H7R0DA01#		±0.5pF	GCG1555G1H8R8DA01#						
8.1pF	±0.1pF	GCG1555G1H7R1BA01#	9.9pF	±0.1pF	GCG1555G1H8R9BA01#						
	±0.25pF	GCG1555G1H7R1CA01#		±0.25pF	GCG1555G1H8R9CA01#						
8.2pF	±0.5pF	GCG1555G1H7R1DA01#	10.0pF	±0.5pF	GCG1555G1H8R9DA01#						
	±0.1pF	GCG1555G1H7R2BA01#		±0.1pF	GCG1555G1H9R0BA01#						
8.3pF	±0.25pF	GCG1555G1H7R2CA01#	10.1pF	±0.25pF	GCG1555G1H9R0CA01#						
	±0.5pF	GCG1555G1H7R2DA01#		±0.5pF	GCG1555G1H9R0DA01#						
8.4pF	±0.1pF	GCG1555G1H7R3BA01#	10.2pF	±0.1pF	GCG1555G1H9R1BA01#						
	±0.25pF	GCG1555G1H7R3CA01#		±0.25pF	GCG1555G1H9R1CA01#						
8.5pF	±0.5pF	GCG1555G1H7R3DA01#	10.3pF	±0.5pF	GCG1555G1H9R1DA01#						
	±0.1pF	GCG1555G1H7R4BA01#		±0.1pF	GCG1555G1H9R2BA01#						
8.6pF	±0.25pF	GCG1555G1H7R4CA01#	10.4pF	±0.25pF	GCG1555G1H9R2CA01#						
	±0.5pF	GCG1555G1H7R4DA01#		±0.5pF	GCG1555G1H9R2DA01#						
8.7pF	±0.1pF	GCG1555G1H7R5BA01#	10.5pF	±0.1pF	GCG1555G1H9R3BA01#						
	±0.25pF	GCG1555G1H7R5CA01#		±0.25pF	GCG1555G1H9R3CA01#						
8.8pF	±0.5pF	GCG1555G1H7R5DA01#	10.6pF	±0.5pF	GCG1555G1H9R3DA01#						
	±0.1pF	GCG1555G1H7R6BA01#		±0.1pF	GCG1555G1H9R4BA01#						
8.9pF	±0.25pF	GCG1555G1H7R6CA01#	10.7pF	±0.25pF	GCG1555G1H9R4CA01#						
	±0.5pF	GCG1555G1H7R6DA01#		±0.5pF	GCG1555G1H9R4DA01#						
9.0pF	±0.1pF	GCG1555G1H7R7BA01#	10.8pF	±0.1pF	GCG1555G1H9R5BA01#						
	±0.25pF	GCG1555G1H7R7CA01#		±0.25pF	GCG1555G1H9R5CA01#						
9.1pF	±0.5pF	GCG1555G1H7R7DA01#	10.9pF	±0.5pF	GCG1555G1H9R5DA01#						
	±0.1pF	GCG1555G1H7R8BA01#		±0.1pF	GCG1555G1H9R6BA01#						
9.2pF	±0.25pF	GCG1555G1H7R8CA01#	11.0pF	±0.25pF	GCG1555G1H9R6CA01#						
	±0.5pF	GCG1555G1H7R8DA01#		±0.5pF	GCG1555G1H9R6DA01#						
9.3pF	±0.1pF	GCG1555G1H7R9BA01#	11.1pF	±0.1pF	GCG1555G1H9R7BA01#						
	±0.25pF	GCG1555G1H7R9CA01#		±0.25pF	GCG1555G1H9R7CA01#						
9.4pF	±0.5pF	GCG1555G1H7R9DA01#	11.2pF	±0.5pF	GCG1555G1H9R7DA01#						
	±0.1pF	GCG1555G1H8R0BA01#		±0.1pF	GCG1555G1H9R8BA01#						
9.5pF	±0.25pF	GCG1555G1H8R0CA01#	11.3pF	±0.25pF	GCG1555G1H9R8CA01#						
	±0.5pF	GCG1555G1H8R0DA01#		±0.5pF	GCG1555G1H9R8DA01#						
9.6pF	±0.1pF	GCG1555G1H8R1BA01#	11.4pF	±0.1pF	GCG1555G1H9R9BA01#						
	±0.25pF	GCG1555G1H8R1CA01#		±0.25pF	GCG1555G1H9R9CA01#						
9.7pF	±0.5pF	GCG1555G1H8R1DA01#	11.5pF	±0.5pF	GCG1555G1H9R9DA01#						
	±0.1pF	GCG1555G1H8R2BA01#		±0.1pF	GCG1555G1H9R0BA01#						
9.8pF	±0.25pF	GCG1555G1H8R2CA01#	11.6pF	±0.25pF	GCG1555G1H9R0CA01#						
	±0.5pF	GCG1555G1H8R2DA01#		±0.5pF	GCG1555G1H9R0DA01#						
9.9pF	±0.1pF	GCG1555G1H8R3BA01#	11.7pF	±0.1pF	GCG1555G1H9R1BA01#						
	±0.25pF	GCG1555G1H8R3CA01#		±0.25pF	GCG1555G1H9R1CA01#						
10.0pF	±0.5pF	GCG1555G1H8R3DA01#	11.8pF	±0.5pF	GCG1555G1H9R1DA01#						
	±0.1pF	GCG1555G1H8R4BA01#		±0.1pF	GCG1555G1H9R2BA01#						
10.1pF	±0.25pF	GCG1555G1H8R4CA01#	11.9pF	±0.25pF	GCG1555G1H9R2CA01#						
	±0.5pF	GCG1555G1H8R4DA01#		±0.5pF	GCG1555G1H9R2DA01#						
10.2pF	±0.1pF	GCG1555G1H8R5BA01#	12.0pF	±0.1pF	GCG1555G1H9R3BA01#						
	±0.25pF	GCG1555G1H8R5CA01#		±0.25pF	GCG1555G1H9R3CA01#						
10.3pF	±0.5pF	GCG1555G1H8R5DA01#	12.1pF	±0.5pF	GCG1555G1H9R3DA01#						
	±0.1pF	GCG1555G1H8R6BA01#		±0.1pF	GCG1555G1H9R4BA01#						
10.4pF	±0.25pF	GCG1555G1H8R6CA01#	12.2pF	±0.25pF	GCG1555G1H9R4CA01#						
	±0.5pF	GCG1555G1H8R6DA01#		±0.5pF	GCG1555G1H9R4DA01#						
10.5pF	±0.1pF	GCG1555G1H8R7BA01#	12.3pF	±0.1pF	GCG1555G1H9R5BA01#						
	±0.25pF	GCG1555G1H8R7CA01#		±0.25pF	GCG1555G1H9R5CA01#						
10.6pF	±0.5pF	GCG1555G1H8R7DA01#	12.4pF	±0.5pF	GCG1555G1H9R5DA01#						
	±0.1pF	GCG1555G1H8R8BA01#		±0.1pF	GCG1555G1H9R6BA01#						
10.7pF	±0.25pF	GCG1555G1H8R8CA01#	12.5pF	±0.25pF	GCG1555G1H9R6CA01#						
	±0.5pF	GCG1555G1H8R8DA01#		±0.5pF	GCG1555G1H9R6DA01#						
10.8pF	±0.1pF	GCG1555G1H8R9BA01#	12.6pF	±0.1pF	GCG1555G1H9R7BA01#						
	±0.25pF	GCG1555G1H8R9CA01#		±0.25pF	GCG1555G1H9R7CA01#						
10.9pF	±0.5pF	GCG1555G1H8R9DA01#	12.7pF	±0.5pF	GCG1555G1H9R7DA01#						
	±0.1pF	GCG1555G1H9R0BA01#		±0.1pF	GCG1555G1H9R8BA01#						
11.0pF	±0.25pF	GCG1555G1H9R0CA01#	12.8pF	±0.25pF	GCG1555G1H9R8CA01#						
	±0.5pF	GCG1555G1H9R0DA01#		±0.5pF	GCG1555G1H9R8DA01#						

Part number # indicates the package specification code.

GRT Series
 GCM Series
 GC3 Series
 GCJ Series
 GCQ Series
 GCD Series
 GCE Series
 NMF Series
 KCM Series
 KC3 Series
 KCA Series
 GCB Series
 GCG Series
 ⚠Caution /Notice

GCG Series Temperature Compensating Type Part Number List

(→ 1.0×0.5mm)

T max.	Rated Voltage	TC Code	Cap.	Tol.	Part Number	T max.	Rated Voltage	TC Code	Cap.	Tol.	Part Number	
0.55mm	50Vdc	X8G	8.6pF	±0.25pF	GCG1555G1H8R6CA01#	0.55mm	50Vdc	X8G	18pF	±2%	GCG1555G1H180GA01#	
				±0.5pF	GCG1555G1H8R6DA01#					±5%	GCG1555G1H180JA01#	
			8.7pF	±0.1pF	GCG1555G1H8R7BA01#				20pF	±2%	GCG1555G1H200GA01#	
				±0.25pF	GCG1555G1H8R7CA01#					±5%	GCG1555G1H200JA01#	
				±0.5pF	GCG1555G1H8R7DA01#					22pF	±2%	GCG1555G1H220GA01#
				±0.1pF	GCG1555G1H8R8BA01#						±5%	GCG1555G1H220JA01#
			8.8pF	±0.25pF	GCG1555G1H8R8CA01#				24pF	±2%	GCG1555G1H240GA01#	
				±0.5pF	GCG1555G1H8R8DA01#					±5%	GCG1555G1H240JA01#	
				±0.1pF	GCG1555G1H8R9BA01#					27pF	±2%	GCG1555G1H270GA01#
			±0.25pF	GCG1555G1H8R9CA01#	±5%				GCG1555G1H270JA01#			
			8.9pF	±0.5pF	GCG1555G1H8R9DA01#				30pF	±2%	GCG1555G1H300GA01#	
				±0.1pF	GCG1555G1H9R0BA01#					±5%	GCG1555G1H300JA01#	
				±0.25pF	GCG1555G1H9R0CA01#					33pF	±2%	GCG1555G1H330GA01#
			±0.5pF	GCG1555G1H9R0DA01#	±5%				GCG1555G1H330JA01#			
			9.1pF	±0.1pF	GCG1555G1H9R1BA01#				36pF	±2%	GCG1555G1H360GA01#	
				±0.25pF	GCG1555G1H9R1CA01#					±5%	GCG1555G1H360JA01#	
				±0.5pF	GCG1555G1H9R1DA01#					39pF	±2%	GCG1555G1H390GA01#
			±0.1pF	GCG1555G1H9R2BA01#	±5%				GCG1555G1H390JA01#			
			9.2pF	±0.25pF	GCG1555G1H9R2CA01#				43pF	±2%	GCG1555G1H430GA01#	
				±0.5pF	GCG1555G1H9R2DA01#					±5%	GCG1555G1H430JA01#	
				±0.1pF	GCG1555G1H9R3BA01#					47pF	±2%	GCG1555G1H470GA01#
			±0.25pF	GCG1555G1H9R3CA01#	±5%				GCG1555G1H470JA01#			
			9.3pF	±0.5pF	GCG1555G1H9R3DA01#				51pF	±2%	GCG1555G1H510GA01#	
				±0.1pF	GCG1555G1H9R4BA01#					±5%	GCG1555G1H510JA01#	
				±0.25pF	GCG1555G1H9R4CA01#					56pF	±2%	GCG1555G1H560GA01#
			±0.5pF	GCG1555G1H9R4DA01#	±5%				GCG1555G1H560JA01#			
			9.4pF	±0.1pF	GCG1555G1H9R5BA01#				62pF	±2%	GCG1555G1H620GA01#	
				±0.25pF	GCG1555G1H9R5CA01#					±5%	GCG1555G1H620JA01#	
				±0.5pF	GCG1555G1H9R5DA01#					68pF	±2%	GCG1555G1H680GA01#
			±0.1pF	GCG1555G1H9R6BA01#	±5%				GCG1555G1H680JA01#			
			9.5pF	±0.25pF	GCG1555G1H9R6CA01#				75pF	±2%	GCG1555G1H750GA01#	
				±0.5pF	GCG1555G1H9R6DA01#					±5%	GCG1555G1H750JA01#	
				±0.1pF	GCG1555G1H9R7BA01#					82pF	±2%	GCG1555G1H820GA01#
			±0.25pF	GCG1555G1H9R7CA01#	±5%				GCG1555G1H820JA01#			
			9.6pF	±0.5pF	GCG1555G1H9R7DA01#				91pF	±2%	GCG1555G1H910GA01#	
				±0.1pF	GCG1555G1H9R8BA01#					±5%	GCG1555G1H910JA01#	
				±0.25pF	GCG1555G1H9R8CA01#					100pF	±2%	GCG1555G1H101GA01#
			±0.5pF	GCG1555G1H9R8DA01#	±5%				GCG1555G1H101JA01#			
			9.7pF	±0.1pF	GCG1555G1H9R9BA01#				110pF	±2%	GCG1555G1H111GA01#	
				±0.25pF	GCG1555G1H9R9CA01#					±5%	GCG1555G1H111JA01#	
				±0.5pF	GCG1555G1H9R9DA01#					120pF	±2%	GCG1555G1H121GA01#
			±1%	GCG1555G1H100FA01#	±5%				GCG1555G1H121JA01#			
			9.8pF	±2.5%	GCG1555G1H100RA01#				130pF	±2%	GCG1555G1H131GA01#	
				±5%	GCG1555G1H100JA01#					±5%	GCG1555G1H131JA01#	
				±2%	GCG1555G1H110GA01#					150pF	±2%	GCG1555G1H151GA01#
			±5%	GCG1555G1H110JA01#	±5%				GCG1555G1H151JA01#			
			9.9pF	±2%	GCG1555G1H120GA01#				160pF	±2%	GCG1555G1H161GA01#	
				±5%	GCG1555G1H120JA01#					±5%	GCG1555G1H161JA01#	
			10pF	±2%	GCG1555G1H130GA01#				180pF	±2%	GCG1555G1H181GA01#	
				±5%	GCG1555G1H130JA01#					±5%	GCG1555G1H181JA01#	
			11pF	±2%	GCG1555G1H130JA01#				200pF	±2%	GCG1555G1H201GA01#	
				±5%	GCG1555G1H130JA01#					±5%	GCG1555G1H201JA01#	
			12pF	±2%	GCG1555G1H150GA01#				220pF	±2%	GCG1555G1H221GA01#	
				±5%	GCG1555G1H150JA01#					±5%	GCG1555G1H221JA01#	
			13pF	±2%	GCG1555G1H150JA01#					±2%	GCG1555G1H221GA01#	
				±5%	GCG1555G1H150JA01#					±5%	GCG1555G1H221JA01#	
			15pF	±2%	GCG1555G1H160GA01#					±2%	GCG1555G1H221GA01#	
				±5%	GCG1555G1H160JA01#					±5%	GCG1555G1H221JA01#	
			16pF	±2%	GCG1555G1H160JA01#					±2%	GCG1555G1H221GA01#	
				±5%	GCG1555G1H160JA01#					±5%	GCG1555G1H221JA01#	

Part number # indicates the package specification code.

GRT Series
 GCM Series
 GC3 Series
 GCJ Series
 GCQ Series
 GCD Series
 GCE Series
 NMF Series
 KCM Series
 KC3 Series
 KCA Series
 GCB Series
 GCG Series
 ⚠Caution /Notice

GCG Series Temperature Compensating Type **Power-train** **AEC-Q200** **Deflecting crack** **Soldering crack** **Limited to conductive glue mounting** Part Number List

(→ 1.0×0.5mm)

T max.	Rated Voltage	TC Code	Cap.	Tol.	Part Number
0.55mm	50Vdc	X8G	240pF	±2%	GCG1555G1H241GA01#
				±5%	GCG1555G1H241JA01#
			270pF	±2%	GCG1555G1H271GA01#
				±5%	GCG1555G1H271JA01#
			300pF	±2%	GCG1555G1H301GA01#
				±5%	GCG1555G1H301JA01#
			330pF	±2%	GCG1555G1H331GA01#
				±5%	GCG1555G1H331JA01#
			360pF	±2%	GCG1555G1H361GA01#
				±5%	GCG1555G1H361JA01#
			390pF	±2%	GCG1555G1H391GA01#
				±5%	GCG1555G1H391JA01#
			430pF	±2%	GCG1555G1H431GA01#
				±5%	GCG1555G1H431JA01#
			470pF	±2%	GCG1555G1H471GA01#
				±5%	GCG1555G1H471JA01#

T max.	Rated Voltage	TC Code	Cap.	Tol.	Part Number	
0.9mm	100Vdc	X8G	12pF	±5%	GCG1885G2A120JA01#	
				13pF	±1%	GCG1885G2A130FA01#
					±2%	GCG1885G2A130GA01#
			15pF	±5%	GCG1885G2A130JA01#	
				±1%	GCG1885G2A150FA01#	
				±2%	GCG1885G2A150GA01#	
			16pF	±5%	GCG1885G2A150JA01#	
				±1%	GCG1885G2A160FA01#	
				±2%	GCG1885G2A160GA01#	
			18pF	±5%	GCG1885G2A160JA01#	
				±1%	GCG1885G2A180FA01#	
				±2%	GCG1885G2A180GA01#	
			18pF	±5%	GCG1885G2A180JA01#	
				±1%	GCG1885G2A200FA01#	
				±2%	GCG1885G2A200GA01#	
			20pF	±5%	GCG1885G2A200JA01#	
				±1%	GCG1885G2A220FA01#	
				±2%	GCG1885G2A220GA01#	
			22pF	±5%	GCG1885G2A220JA01#	
				±1%	GCG1885G2A220FA01#	
				±2%	GCG1885G2A220GA01#	
			24pF	±5%	GCG1885G2A220JA01#	
				±1%	GCG1885G2A240FA01#	
				±2%	GCG1885G2A240GA01#	
			24pF	±5%	GCG1885G2A240JA01#	
				±1%	GCG1885G2A270FA01#	
				±2%	GCG1885G2A270GA01#	
			27pF	±5%	GCG1885G2A270JA01#	
				±1%	GCG1885G2A300FA01#	
				±2%	GCG1885G2A300GA01#	
			30pF	±5%	GCG1885G2A300JA01#	
				±1%	GCG1885G2A330FA01#	
				±2%	GCG1885G2A330GA01#	
			33pF	±5%	GCG1885G2A330JA01#	
				±1%	GCG1885G2A360FA01#	
				±2%	GCG1885G2A360GA01#	
			36pF	±5%	GCG1885G2A360JA01#	
				±1%	GCG1885G2A390FA01#	
				±2%	GCG1885G2A390GA01#	
			39pF	±5%	GCG1885G2A390JA01#	
				±1%	GCG1885G2A430FA01#	
				±2%	GCG1885G2A430GA01#	
			43pF	±5%	GCG1885G2A430JA01#	
				±1%	GCG1885G2A470FA01#	
				±2%	GCG1885G2A470GA01#	
			47pF	±5%	GCG1885G2A470JA01#	
				±1%	GCG1885G2A510FA01#	
				±2%	GCG1885G2A510GA01#	
51pF	±5%	GCG1885G2A510JA01#				
	±1%	GCG1885G2A560FA01#				
	±2%	GCG1885G2A560GA01#				
56pF	±5%	GCG1885G2A560JA01#				
	±1%	GCG1885G2A620FA01#				
	±2%	GCG1885G2A620GA01#				
62pF	±5%	GCG1885G2A620JA01#				
	±1%	GCG1885G2A680FA01#				
	±2%	GCG1885G2A680GA01#				
68pF	±5%	GCG1885G2A680JA01#				
	±1%	GCG1885G2A120GA01#				

1.6×0.8mm

T max.	Rated Voltage	TC Code	Cap.	Tol.	Part Number	
0.9mm	100Vdc	U2J	1000pF	±5%	GCG1887U2A102JA01#	
			1100pF	±5%	GCG1887U2A112JA01#	
			1200pF	±5%	GCG1887U2A122JA01#	
			1300pF	±5%	GCG1887U2A132JA01#	
			1500pF	±5%	GCG1887U2A152JA01#	
			1600pF	±5%	GCG1887U2A162JA01#	
			1800pF	±5%	GCG1887U2A182JA01#	
			2000pF	±5%	GCG1887U2A202JA01#	
			2200pF	±5%	GCG1887U2A222JA01#	
			2400pF	±5%	GCG1887U2A242JA01#	
			2700pF	±5%	GCG1887U2A272JA01#	
			3000pF	±5%	GCG1887U2A302JA01#	
			3300pF	±5%	GCG1887U2A332JA01#	
			3600pF	±5%	GCG1887U2A362JA01#	
			3900pF	±5%	GCG1887U2A392JA01#	
			4300pF	±5%	GCG1887U2A432JA01#	
			4700pF	±5%	GCG1887U2A472JA01#	
			5100pF	±5%	GCG1887U2A512JA01#	
			5600pF	±5%	GCG1887U2A562JA01#	
			6200pF	±5%	GCG1887U2A622JA01#	
			6800pF	±5%	GCG1887U2A682JA01#	
			7500pF	±5%	GCG1887U2A752JA01#	
			8200pF	±5%	GCG1887U2A822JA01#	
			9100pF	±5%	GCG1887U2A912JA01#	
			10000pF	±5%	GCG1887U2A103JA01#	
			X8G	10pF	±1%	GCG1885G2A100FA01#
					±2%	GCG1885G2A100GA01#
					±5%	GCG1885G2A100JA01#
				11pF	±1%	GCG1885G2A110FA01#
					±2%	GCG1885G2A110GA01#
		±5%			GCG1885G2A110JA01#	
		12pF	±1%	GCG1885G2A120FA01#		
			±2%	GCG1885G2A120GA01#		

Part number # indicates the package specification code.

GRT Series
 GCM Series
 GC3 Series
 GCJ Series
 GCQ Series
 GCD Series
 GCE Series
 NMF Series
 KCM Series
 KC3 Series
 KCA Series
 GCB Series
 GCG Series
 ⚠Caution /Notice

GCG Series Temperature Compensating Type Part Number List

(→ 1.6×0.8mm)

T max.	Rated Voltage	TC Code	Cap.	Tol.	Part Number	T max.	Rated Voltage	TC Code	Cap.	Tol.	Part Number		
0.9mm	100Vdc	X8G	68pF	±5%	GCG1885G2A680JA01#	0.9mm	100Vdc	X8G	390pF	±5%	GCG1885G2A391JA01#		
				±1%	GCG1885G2A750FA01#					430pF	±1%	GCG1885G2A431FA01#	
					±2%						GCG1885G2A750GA01#	±2%	GCG1885G2A431GA01#
			±5%		GCG1885G2A750JA01#				±5%		GCG1885G2A431JA01#		
			82pF	±1%	GCG1885G2A820FA01#				470pF	±1%	GCG1885G2A471FA01#		
				±2%	GCG1885G2A820GA01#					±2%	GCG1885G2A471GA01#		
				±5%	GCG1885G2A820JA01#					±5%	GCG1885G2A471JA01#		
			91pF	±1%	GCG1885G2A910FA01#				510pF	±1%	GCG1885G2A511FA01#		
				±2%	GCG1885G2A910GA01#					±2%	GCG1885G2A511GA01#		
				±5%	GCG1885G2A910JA01#					±5%	GCG1885G2A511JA01#		
			100pF	±1%	GCG1885G2A101FA01#				560pF	±1%	GCG1885G2A561FA01#		
				±2%	GCG1885G2A101GA01#					±2%	GCG1885G2A561GA01#		
				±5%	GCG1885G2A101JA01#					±5%	GCG1885G2A561JA01#		
			110pF	±1%	GCG1885G2A111FA01#				620pF	±1%	GCG1885G2A621FA01#		
				±2%	GCG1885G2A111GA01#					±2%	GCG1885G2A621GA01#		
				±5%	GCG1885G2A111JA01#					±5%	GCG1885G2A621JA01#		
			120pF	±1%	GCG1885G2A121FA01#				680pF	±1%	GCG1885G2A681FA01#		
				±2%	GCG1885G2A121GA01#					±2%	GCG1885G2A681GA01#		
				±5%	GCG1885G2A121JA01#					±5%	GCG1885G2A681JA01#		
			130pF	±1%	GCG1885G2A131FA01#				750pF	±1%	GCG1885G2A751FA01#		
				±2%	GCG1885G2A131GA01#					±2%	GCG1885G2A751GA01#		
				±5%	GCG1885G2A131JA01#					±5%	GCG1885G2A751JA01#		
			150pF	±1%	GCG1885G2A151FA01#				820pF	±1%	GCG1885G2A821FA01#		
				±2%	GCG1885G2A151GA01#					±2%	GCG1885G2A821GA01#		
				±5%	GCG1885G2A151JA01#					±5%	GCG1885G2A821JA01#		
			160pF	±1%	GCG1885G2A161FA01#				910pF	±1%	GCG1885G2A911FA01#		
				±2%	GCG1885G2A161GA01#					±2%	GCG1885G2A911GA01#		
				±5%	GCG1885G2A161JA01#					±5%	GCG1885G2A911JA01#		
			180pF	±1%	GCG1885G2A181FA01#				1000pF	±1%	GCG1885G2A102FA01#		
				±2%	GCG1885G2A181GA01#					±2%	GCG1885G2A102GA01#		
				±5%	GCG1885G2A181JA01#					±5%	GCG1885G2A102JA01#		
			200pF	±1%	GCG1885G2A201FA01#				50Vdc	X8G	10pF	±1%	GCG1885G1H100FA01#
				±2%	GCG1885G2A201GA01#							±2%	GCG1885G1H100GA01#
				±5%	GCG1885G2A201JA01#							±5%	GCG1885G1H100JA01#
			220pF	±1%	GCG1885G2A221FA01#				12pF	±2%	GCG1885G1H120GA01#		
				±2%	GCG1885G2A221GA01#					±5%	GCG1885G1H120JA01#		
				±5%	GCG1885G2A221JA01#					15pF	±2%	GCG1885G1H150GA01#	
			240pF	±1%	GCG1885G2A241FA01#				±5%		GCG1885G1H150JA01#		
				±2%	GCG1885G2A241GA01#				18pF		±2%	GCG1885G1H180GA01#	
				±5%	GCG1885G2A241JA01#					±5%	GCG1885G1H180JA01#		
			270pF	±1%	GCG1885G2A271FA01#					22pF	±2%	GCG1885G1H220GA01#	
				±2%	GCG1885G2A271GA01#				±5%		GCG1885G1H220JA01#		
				±5%	GCG1885G2A271JA01#				27pF		±2%	GCG1885G1H270GA01#	
			300pF	±1%	GCG1885G2A301FA01#					±5%	GCG1885G1H270JA01#		
				±2%	GCG1885G2A301GA01#					33pF	±2%	GCG1885G1H330GA01#	
				±5%	GCG1885G2A301JA01#				±5%		GCG1885G1H330JA01#		
			330pF	±1%	GCG1885G2A331FA01#				39pF		±2%	GCG1885G1H390GA01#	
				±2%	GCG1885G2A331GA01#					±5%	GCG1885G1H390JA01#		
				±5%	GCG1885G2A331JA01#					47pF	±2%	GCG1885G1H470GA01#	
			360pF	±1%	GCG1885G2A361FA01#				±5%		GCG1885G1H470JA01#		
				±2%	GCG1885G2A361GA01#				56pF		±2%	GCG1885G1H560GA01#	
				±5%	GCG1885G2A361JA01#					±5%	GCG1885G1H560JA01#		
			390pF	±1%	GCG1885G2A391FA01#					68pF	±2%	GCG1885G1H680GA01#	
				±2%	GCG1885G2A391GA01#				±5%		GCG1885G1H680JA01#		

GRT Series
 GCM Series
 GC3 Series
 GCJ Series
 GCQ Series
 GCD Series
 GCE Series
 NMF Series
 KCM Series
 KC3 Series
 KCA Series
 GCB Series
 GCG Series
 ⚠Caution /Notice

Part number # indicates the package specification code.

GCG Series Temperature Compensating Type Power-train AEC-Q200 Deflecting crack Soldering crack Limited to conductive glue mounting Part Number List

(→ 1.6×0.8mm)

T max.	Rated Voltage	TC Code	Cap.	Tol.	Part Number
0.9mm	50Vdc	X8G	82pF	±2%	GCG1885G1H820GA01#
				±5%	GCG1885G1H820JA01#
			100pF	±2%	GCG1885G1H101GA01#
				±5%	GCG1885G1H101JA01#
			120pF	±2%	GCG1885G1H121GA01#
				±5%	GCG1885G1H121JA01#
			150pF	±2%	GCG1885G1H151GA01#
				±5%	GCG1885G1H151JA01#
			180pF	±2%	GCG1885G1H181GA01#
				±5%	GCG1885G1H181JA01#
			220pF	±2%	GCG1885G1H221GA01#
				±5%	GCG1885G1H221JA01#
			270pF	±2%	GCG1885G1H271GA01#
				±5%	GCG1885G1H271JA01#
			330pF	±2%	GCG1885G1H331GA01#
				±5%	GCG1885G1H331JA01#
			390pF	±2%	GCG1885G1H391GA01#
				±5%	GCG1885G1H391JA01#
			470pF	±2%	GCG1885G1H471GA01#
				±5%	GCG1885G1H471JA01#
			560pF	±2%	GCG1885G1H561GA01#
				±5%	GCG1885G1H561JA01#
			680pF	±2%	GCG1885G1H681GA01#
				±5%	GCG1885G1H681JA01#
			820pF	±2%	GCG1885G1H821GA01#
				±5%	GCG1885G1H821JA01#
			1000pF	±2%	GCG1885G1H102GA01#
				±5%	GCG1885G1H102JA01#
			1200pF	±2%	GCG1885G1H122GA01#
				±5%	GCG1885G1H122JA01#
			1500pF	±2%	GCG1885G1H152GA01#
				±5%	GCG1885G1H152JA01#
			1800pF	±2%	GCG1885G1H182GA01#
				±5%	GCG1885G1H182JA01#
			2200pF	±2%	GCG1885G1H222GA01#
				±5%	GCG1885G1H222JA01#

T max.	Rated Voltage	TC Code	Cap.	Tol.	Part Number
0.7mm	50Vdc	X8G	3300pF	±5%	GCG2165G1H332JA01#
				±2%	GCG2165G1H392GA01#
			3900pF	±2%	GCG2165G1H392JA01#
				±5%	GCG2165G1H392JA01#
			4700pF	±2%	GCG2165G1H472GA01#
				±5%	GCG2165G1H472JA01#
0.95mm	50Vdc	X8G	5600pF	±2%	GCG2195G1H562GA01#
				±5%	GCG2195G1H562JA01#
			6800pF	±2%	GCG2195G1H682GA01#
				±5%	GCG2195G1H682JA01#
			8200pF	±2%	GCG2195G1H822GA01#
				±5%	GCG2195G1H822JA01#
			10000pF	±2%	GCG2195G1H103GA01#
				±5%	GCG2195G1H103JA01#

2.0×1.25mm

T max.	Rated Voltage	TC Code	Cap.	Tol.	Part Number
0.7mm	50Vdc	X8G	1000pF	±2%	GCG2165G1H102GA01#
				±5%	GCG2165G1H102JA01#
			1200pF	±2%	GCG2165G1H122GA01#
				±5%	GCG2165G1H122JA01#
			1500pF	±2%	GCG2165G1H152GA01#
				±5%	GCG2165G1H152JA01#
			1800pF	±2%	GCG2165G1H182GA01#
				±5%	GCG2165G1H182JA01#
			2200pF	±2%	GCG2165G1H222GA01#
				±5%	GCG2165G1H222JA01#
			2700pF	±2%	GCG2165G1H272GA01#
				±5%	GCG2165G1H272JA01#
			3300pF	±2%	GCG2165G1H332GA01#

Part number # indicates the package specification code.

GCG Series High Dielectric Constant Type Power-train AEC-Q200 Deflecting crack Soldering crack Limited to conductive paste mounting Part Number List

1.0×0.5mm

T max.	Rated Voltage	TC Code	Cap.	Tol.	Part Number		
0.55mm	50Vdc	X8L	220pF	±10%	GCG155L81H221KA02#		
			270pF	±10%	GCG155L81H271KA02#		
			330pF	±10%	GCG155L81H331KA02#		
			390pF	±10%	GCG155L81H391KA02#		
			470pF	±10%	GCG155L81H471KA02#		
			560pF	±10%	GCG155L81H561KA02#		
			680pF	±10%	GCG155L81H681KA02#		
			820pF	±10%	GCG155L81H821KA02#		
			1000pF	±10%	GCG155L81H102KA02#		
			1200pF	±10%	GCG155L81H122KA02#		
			1500pF	±10%	GCG155L81H152KA02#		
			1800pF	±10%	GCG155L81H182KA02#		
			2200pF	±10%	GCG155L81H222KA02#		
			2700pF	±10%	GCG155L81H272KA02#		
			3300pF	±10%	GCG155L81H332KA02#		
			3900pF	±10%	GCG155L81H392KA02#		
			4700pF	±10%	GCG155L81H472KA02#		
			X7R	50Vdc	220pF	±10%	GCG155R71H221KA01#
						±20%	GCG155R71H221MA01#
					270pF	±10%	GCG155R71H271KA01#
						±20%	GCG155R71H271MA01#
		330pF			±10%	GCG155R71H331KA01#	
					±20%	GCG155R71H331MA01#	
		390pF			±10%	GCG155R71H391KA01#	
					±20%	GCG155R71H391MA01#	
		470pF			±10%	GCG155R71H471KA01#	
					±20%	GCG155R71H471MA01#	
		560pF			±10%	GCG155R71H561KA01#	
					±20%	GCG155R71H561MA01#	
		680pF			±10%	GCG155R71H681KA01#	
					±20%	GCG155R71H681MA01#	
		820pF			±10%	GCG155R71H821KA01#	
					±20%	GCG155R71H821MA01#	
		1000pF			±10%	GCG155R71H102KA01#	
					±20%	GCG155R71H102MA01#	
		1200pF			±10%	GCG155R71H122KA01#	
					±20%	GCG155R71H122MA01#	
		1500pF			±10%	GCG155R71H152KA01#	
					±20%	GCG155R71H152MA01#	
		1800pF			±10%	GCG155R71H182KA01#	
					±20%	GCG155R71H182MA01#	
		2200pF			±10%	GCG155R71H222KA01#	
					±20%	GCG155R71H222MA01#	
		2700pF	±10%	GCG155R71H272KA01#			
			±20%	GCG155R71H272MA01#			
		3300pF	±10%	GCG155R71H332KA01#			
			±20%	GCG155R71H332MA01#			
3900pF	±10%	GCG155R71H392KA01#					
	±20%	GCG155R71H392MA01#					
4700pF	±10%	GCG155R71H472KA01#					
	±20%	GCG155R71H472MA01#					
25Vdc	X8L	5600pF	±10%	GCG155L81E562KA01#			

T max.	Rated Voltage	TC Code	Cap.	Tol.	Part Number			
0.55mm	25Vdc	X8L	5600pF	±20%	GCG155L81E562MA01#			
			6800pF	±10%	GCG155L81E682KA01#			
				±20%	GCG155L81E682MA01#			
			8200pF	±10%	GCG155L81E822KA01#			
				±20%	GCG155L81E822MA01#			
			10000pF	±10%	GCG155L81E103KA01#			
				±20%	GCG155L81E103MA01#			
			X7R	25Vdc	5600pF	±10%	GCG155R71E562KA01#	
						±20%	GCG155R71E562MA01#	
					6800pF	±10%	GCG155R71E682KA01#	
						±20%	GCG155R71E682MA01#	
					8200pF	±10%	GCG155R71E822KA01#	
						±20%	GCG155R71E822MA01#	
					10000pF	±10%	GCG155R71E103KA01#	
		±20%				GCG155R71E103MA01#		
		X8L			16Vdc	15000pF	±10%	GCG155L81C153KA01#
							±20%	GCG155L81C153MA01#
						18000pF	±10%	GCG155L81C183KA01#
							±20%	GCG155L81C183MA01#
						22000pF	±10%	GCG155L81C223KA01#
			±20%	GCG155L81C223MA01#				
	27000pF		±10%	GCG155L81C273KA01#				
			±20%	GCG155L81C273MA01#				
	33000pF		±10%	GCG155L81C333KA01#				
			±20%	GCG155L81C333MA01#				
	39000pF		±10%	GCG155L81C393KA01#				
			±20%	GCG155L81C393MA01#				
	47000pF		±10%	GCG155L81C473KA01#				
			±20%	GCG155L81C473MA01#				
	X7R	16Vdc	15000pF	±10%	GCG155R71C153KA01#			
				±20%	GCG155R71C153MA01#			
			18000pF	±10%	GCG155R71C183KA01#			
				±20%	GCG155R71C183MA01#			
			22000pF	±10%	GCG155R71C223KA01#			
				±20%	GCG155R71C223MA01#			
			27000pF	±10%	GCG155R71C273KA01#			
				±20%	GCG155R71C273MA01#			
			33000pF	±10%	GCG155R71C333KA01#			
				±20%	GCG155R71C333MA01#			
			39000pF	±10%	GCG155R71C393KA01#			
				±20%	GCG155R71C393MA01#			
			47000pF	±10%	GCG155R71C473KA01#			
	±20%	GCG155R71C473MA01#						
	X7R	16Vdc	15000pF	±10%	GCG155R71C153KA01#			
				±20%	GCG155R71C153MA01#			
			18000pF	±10%	GCG155R71C183KA01#			
				±20%	GCG155R71C183MA01#			
22000pF			±10%	GCG155R71C223KA01#				
			±20%	GCG155R71C223MA01#				
27000pF			±10%	GCG155R71C273KA01#				
			±20%	GCG155R71C273MA01#				
33000pF			±10%	GCG155R71C333KA01#				
			±20%	GCG155R71C333MA01#				
39000pF			±10%	GCG155R71C393KA01#				
			±20%	GCG155R71C393MA01#				
47000pF			±10%	GCG155R71C473KA01#				
	±20%	GCG155R71C473MA01#						
56000pF	±10%	GCG155R71C563KA01#						
	±20%	GCG155R71C563MA01#						
68000pF	±10%	GCG155R71C683KA01#						
	±20%	GCG155R71C683MA01#						
82000pF	±10%	GCG155R71C823KA01#						
	±20%	GCG155R71C823MA01#						
0.10μF	±10%	GCG155R71C104KA01#						
	±20%	GCG155R71C104MA01#						

GRT Series
 GCM Series
 GC3 Series
 GCJ Series
 GCQ Series
 GCD Series
 GCE Series
 NMF Series
 KCM Series
 KC3 Series
 KCA Series
 GCB Series
 GCG Series
 ⚠Caution /Notice

Part number # indicates the package specification code.

GCG Series High Dielectric Constant Type Power-train AEC-Q200 Defecting crack Soldering crack Limited to conductive glue mounting Part Number List

1.6×0.8mm

T max.	Rated Voltage	TC Code	Cap.	Tol.	Part Number
0.9mm	100Vdc	X8R	1000pF	±10%	GCG188R92A102KA01#
				±20%	GCG188R92A102MA01#
			1200pF	±10%	GCG188R92A122KA01#
				±20%	GCG188R92A122MA01#
			1500pF	±10%	GCG188R92A152KA01#
				±20%	GCG188R92A152MA01#
			1800pF	±10%	GCG188R92A182KA01#
				±20%	GCG188R92A182MA01#
			2200pF	±10%	GCG188R92A222KA01#
				±20%	GCG188R92A222MA01#
			2700pF	±10%	GCG188R92A272KA01#
				±20%	GCG188R92A272MA01#
			3300pF	±10%	GCG188R92A332KA01#
				±20%	GCG188R92A332MA01#
			3900pF	±10%	GCG188R92A392KA01#
				±20%	GCG188R92A392MA01#
			4700pF	±10%	GCG188R92A472KA01#
				±20%	GCG188R92A472MA01#
			5600pF	±10%	GCG188R92A562KA01#
				±20%	GCG188R92A562MA01#
			6800pF	±10%	GCG188R92A682KA01#
				±20%	GCG188R92A682MA01#
			8200pF	±10%	GCG188R92A822KA01#
				±20%	GCG188R92A822MA01#
			10000pF	±10%	GCG188R92A103KA01#
				±20%	GCG188R92A103MA01#
			12000pF	±10%	GCG188R92A123KA01#
				±20%	GCG188R92A123MA01#
			15000pF	±10%	GCG188R92A153KA01#
				±20%	GCG188R92A153MA01#
			18000pF	±10%	GCG188R92A183KA01#
				±20%	GCG188R92A183MA01#
			22000pF	±10%	GCG188R92A223KA01#
				±20%	GCG188R92A223MA01#
			27000pF	±10%	GCG188R92A273KA01#
				±20%	GCG188R92A273MA01#
			33000pF	±10%	GCG188R92A333KA01#
				±20%	GCG188R92A333MA01#
			39000pF	±10%	GCG188R92A393KA01#
				±20%	GCG188R92A393MA01#
			47000pF	±10%	GCG188R92A473KA01#
				±20%	GCG188R92A473MA01#
56000pF	±10%	GCG188R92A563KA01#			
	±20%	GCG188R92A563MA01#			
68000pF	±10%	GCG188R92A683KA01#			
	±20%	GCG188R92A683MA01#			
0.10μF	±10%	GCG188R92A104KA03#			
	±20%	GCG188R92A104MA03#			
50Vdc	X8L	0.15μF	±10%	GCG188L8EH154KA07# D4	
			±20%	GCG188L8EH154MA07# D4	
50Vdc	X8R	1000pF	±10%	GCG188R91H102KA03#	
			±20%	GCG188R91H102MA03#	

T max.	Rated Voltage	TC Code	Cap.	Tol.	Part Number
0.9mm	50Vdc	X8R	1200pF	±10%	GCG188R91H122KA03#
				±20%	GCG188R91H122MA03#
			1500pF	±10%	GCG188R91H152KA03#
				±20%	GCG188R91H152MA03#
			1800pF	±10%	GCG188R91H182KA03#
				±20%	GCG188R91H182MA03#
			2200pF	±10%	GCG188R91H222KA03#
				±20%	GCG188R91H222MA03#
			2700pF	±10%	GCG188R91H272KA03#
				±20%	GCG188R91H272MA03#
			3300pF	±10%	GCG188R91H332KA03#
				±20%	GCG188R91H332MA03#
			3900pF	±10%	GCG188R91H392KA03#
				±20%	GCG188R91H392MA03#
			4700pF	±10%	GCG188R91H472KA03#
				±20%	GCG188R91H472MA03#
			5600pF	±10%	GCG188R91H562KA03#
				±20%	GCG188R91H562MA03#
			6800pF	±10%	GCG188R91H682KA03#
				±20%	GCG188R91H682MA03#
			8200pF	±10%	GCG188R91H822KA03#
				±20%	GCG188R91H822MA03#
			10000pF	±10%	GCG188R91H103KA03#
				±20%	GCG188R91H103MA03#
			15000pF	±10%	GCG188R91H153KA03#
				±20%	GCG188R91H153MA03#
			22000pF	±10%	GCG188R91H223KA03#
				±20%	GCG188R91H223MA03#
			33000pF	±10%	GCG188R91H333KA03#
				±20%	GCG188R91H333MA03#
			47000pF	±10%	GCG188R91H473KA03#
				±20%	GCG188R91H473MA03#
			0.10μF	±10%	GCG188R91H104KA01#
				±20%	GCG188R91H104MA01#
			0.12μF	±10%	GCG188R91H124KA01#
				±20%	GCG188R91H124MA01#
			0.15μF	±10%	GCG188R91H154KA01#
				±20%	GCG188R91H154MA01#
			0.18μF	±10%	GCG188R91H184KA01#
				±20%	GCG188R91H184MA01#
			0.22μF	±10%	GCG188R91H224KA01#
				±20%	GCG188R91H224MA01#
0.15μF	X7R	0.15μF	±10%	GCG188R71H154KA01#	
			±20%	GCG188R71H154MA01#	
0.22μF	X7R	0.22μF	±10%	GCG188R71H224KA01#	
			±20%	GCG188R71H224MA01#	
25Vdc	X8R	0.33μF	±10%	GCG188R91E334KA01#	
			±20%	GCG188R91E334MA01#	
		0.39μF	±10%	GCG188R91E394KA01#	
			±20%	GCG188R91E394MA01#	
		0.47μF	±10%	GCG188R91E474KA01#	
			±20%	GCG188R91E474MA01#	
0.12μF	X7R	0.12μF	±5%	GCG188R71E124JA12#	
			±10%	GCG188R71E124KA12#	

Part number # indicates the package specification code.

GRT Series
 GCM Series
 GC3 Series
 GCJ Series
 GCQ Series
 GCD Series
 GCE Series
 NMF Series
 KCM Series
 KC3 Series
 KCA Series
 GCB Series
 GCG Series
 ⚠Caution /Notice

GCG Series High Dielectric Constant Type Power-train AEC-Q200 Defecting crack Soldering crack Limited to conductive glue mounting Part Number List

(→ 1.6×0.8mm)

T max.	Rated Voltage	TC Code	Cap.	Tol.	Part Number			
0.9mm	25Vdc	X7R	0.12μF	±20%	GCG188R71E124MA12#			
				0.15μF	±5%	GCG188R71E154JA12#		
					±10%	GCG188R71E154KA12#		
					±20%	GCG188R71E154MA12#		
			0.18μF	±5%	GCG188R71E184JA12#			
				±10%	GCG188R71E184KA12#			
				±20%	GCG188R71E184MA12#			
				0.22μF	±5%	GCG188R71E224JA12#		
			±10%		GCG188R71E224KA12#			
			±20%		GCG188R71E224MA12#			
			16Vdc		X8L	0.15μF	±10%	GCG188L81C154KA01#
				±20%			GCG188L81C154MA01#	
	0.22μF	±10%		GCG188L81C224KA01#				
		±20%		GCG188L81C224MA01#				
		1.0μF		±10%		GCG188L8EE105KA07#	D4	
		X7R		1.0μF		±10%	GCG188R71C105KA01#	
	±20%				GCG188R71C105MA01#			
	10Vdc	X7S		2.2μF	±10%	GCG188C71A225KE01#		
			±20%		GCG188C71A225ME01#			
	6.3Vdc	X7R	2.2μF	±10%	GCG188R70J225KE01#			
±20%				GCG188R70J225ME01#				

2.0×1.25mm

T max.	Rated Voltage	TC Code	Cap.	Tol.	Part Number				
1.45mm	50Vdc	X8L	1.0μF	±10%	GCG21BL8EH105KA07#	D4			
				X7R	0.15μF	±5%	GCG21BR71H154JA01#		
						±10%	GCG21BR71H154KA01#		
						±20%	GCG21BR71H154MA01#		
		0.18μF	±5%		GCG21BR71H184JA01#				
			±10%		GCG21BR71H184KA01#				
			±20%		GCG21BR71H184MA01#				
			0.22μF		±5%	GCG21BR71H224JA01#			
		±10%			GCG21BR71H224KA01#				
		±20%			GCG21BR71H224MA01#				
		0.33μF			±10%	GCG21BR71H334KA01#			
			±20%		GCG21BR71H334MA01#				
			0.47μF		±10%	GCG21BR71H474KA01#			
				±20%	GCG21BR71H474MA01#				
		1.0μF		±10%	GCG21BR71H105KA01#				
				±20%	GCG21BR71H105MA01#				
		35Vdc	X8L	0.68μF	±10%	GCG21BL8EG684KA07#	D4		
					±10%	GCG21BL8EG105KA07#	D4		
			X7R	0.68μF	±10%	GCG21BR7YA684KA01#			
					±20%	GCG21BR7YA684MA01#			
	1.0μF			±10%	GCG21BR7YA105KA01#				
				±20%	GCG21BR7YA105MA01#				
				25Vdc	X8L	0.33μF	±10%	GCG21BL81E334KA01#	
							±20%	GCG21BL81E334MA01#	
	X8R	0.68μF	±10%		GCG21BR91E684KE01#				
			±20%		GCG21BR91E684ME01#				
		0.82μF	±10%	GCG21BR91E824KE01#					
			±20%	GCG21BR91E824ME01#					

T max.	Rated Voltage	TC Code	Cap.	Tol.	Part Number			
1.45mm	25Vdc	X8R	1.0μF	±10%	GCG21BR91E105KE01#			
				±20%	GCG21BR91E105ME01#			
				X7R	0.27μF	±5%	GCG21BR71E274JA01#	
						±10%	GCG21BR71E274KA01#	
			±20%		GCG21BR71E274MA01#			
					0.33μF	±5%	GCG21BR71E334JA01#	
			±10%	GCG21BR71E334KA01#				
			±20%	GCG21BR71E334MA01#				
			0.39μF	±5%		GCG21BR71E394JA01#		
				±10%	GCG21BR71E394KA01#			
				±20%	GCG21BR71E394MA01#			
				0.47μF	±5%	GCG21BR71E474JA01#		
		±10%	GCG21BR71E474KA01#					
		±20%	GCG21BR71E474MA01#					
		0.56μF	±5%		GCG21BR71E564JA01#			
			±10%		GCG21BR71E564KA01#			
			±20%		GCG21BR71E564MA01#			
			0.68μF	±5%	GCG21BR71E684JA01#			
		±10%		GCG21BR71E684KA01#				
		±20%		GCG21BR71E684MA01#				
		0.82μF		±5%	GCG21BR71E824JA01#			
				±10%	GCG21BR71E824KA01#			
				±20%	GCG21BR71E824MA01#			
			1.0μF	±5%	GCG21BR71E105JA12#			
	±10%	GCG21BR71E105KA12#						
	±20%	GCG21BR71E105MA12#						
	16Vdc	X8L		0.33μF	±10%	GCG21BL81C334KA01#		
					±20%	GCG21BL81C334MA01#		
				0.39μF	±10%	GCG21BL81C394KA01#		
			±20%		GCG21BL81C394MA01#			
			0.47μF	±10%	GCG21BL81C474KA01#			
				±20%	GCG21BL81C474MA01#			
		0.56μF	±10%	GCG21BL81C564KA01#				
			±20%	GCG21BL81C564MA01#				
			0.68μF	±10%	GCG21BL81C684KA01#			
				±20%	GCG21BL81C684MA01#			
		0.82μF	±10%	GCG21BL81C824KA01#				
			±20%	GCG21BL81C824MA01#				
	X7R		4.7μF	±10%	GCG21BR71C475KA12#			
	10Vdc	X7R	10μF	±10%	GCG21BR71A106KE01#			
				±20%	GCG21BR71A106ME01#			
	6.3Vdc	X8L	10μF	±10%	GCG21BL8EC106KE07#	D4		
				X7R	10μF	±10%	GCG21BR70J106KE01#	
	±20%	GCG21BR70J106ME01#						

3.2×1.6mm

T max.	Rated Voltage	TC Code	Cap.	Tol.	Part Number	
1.35mm	50Vdc	X8R	0.22μF	±10%	GCG31MR91H224KA03#	
				±20%	GCG31MR91H224MA03#	
			0.33μF	±10%	GCG31MR91H334KA03#	
				±20%	GCG31MR91H334MA03#	
	25Vdc	X7R	1.2μF	±5%	GCG31MR71E125JA01#	

Part number # indicates the package specification code.

GCG Series High Dielectric Constant Type Part Number List

(→ 3.2×1.6mm)

T max.	Rated Voltage	TC Code	Cap.	Tol.	Part Number			
1.35mm	25Vdc	X7R	1.2μF	±10%	GCG31MR71E125KA01#			
				±20%	GCG31MR71E125MA01#			
			1.5μF	±5%	GCG31MR71E155JA01#			
				±10%	GCG31MR71E155KA01#			
				±20%	GCG31MR71E155MA01#			
				2.2μF	±5%	GCG31MR71E225JA12#		
		±10%	GCG31MR71E225KA12#					
		16Vdc	X8L	1.0μF	±10%	GCG31ML81C105KA01#		
					±20%	GCG31ML81C105MA01#		
			1.5μF	±10%	GCG31ML81C155KA01#			
				±20%	GCG31ML81C155MA01#			
				1.9mm	25Vdc	X8R	1.0μF	±10%
±20%	GCG31CR91E105MA03#							
X7R	3.3μF	±5%	GCG31CR71E335JA01#					
		±10%	GCG31CR71E335KA01#					
		±20%	GCG31CR71E335MA01#					
	3.9μF	±5%	GCG31CR71E395JA01#					
		±10%	GCG31CR71E395KA01#					
		±20%	GCG31CR71E395MA01#					
4.7μF	±5%	GCG31CR71E475JA01#						
	±10%	GCG31CR71E475KA01#						
	±20%	GCG31CR71E475MA01#						
	16Vdc	X8L	3.3μF			±10%	GCG31CL81C335KA01#	
				±20%	GCG31CL81C335MA01#			
		4.7μF	±10%	GCG31CL81C475KA01#				
±20%			GCG31CL81C475MA01#					
X8R			0.68μF	±10%	GCG31CR91C684KA01#			
				±20%	GCG31CR91C684MA01#			
	1.0μF	±10%	GCG31CR91C105KA01#					
		±20%	GCG31CR91C105MA01#					
6.3Vdc	X7R	22μF	±10%	GCG31CR70J226KE01#				
			±20%	GCG31CR70J226ME01#				

3.2×2.5mm

T max.	Rated Voltage	TC Code	Cap.	Tol.	Part Number			
2.8mm	50Vdc	X8L	10μF	±10%	GCG32EL8EH106KA07#	D4		
				±20%	GCG32EC71H106MA01#			
		X7S	10μF	±10%	GCG32EC71H106KA01#			
				±20%	GCG32EC71H106MA01#			
			35Vdc	X8L	10μF	±10%	GCG32EL8EG106KA07#	D4
						±20%	GCG32EC7YA106MA01#	
	25Vdc	X7S	10μF	±10%	GCG32EC7YA106KA01#			
				±20%	GCG32EC7YA106MA01#			
		X8L	22μF	±10%	GCG32EL8EF226KE07#	D4		
				±20%	GCG32ER71E106KA12#			
			X7R	10μF	±10%	GCG32ER71E106KA12#		
					±20%	GCG32ER71E106MA12#		
	16Vdc	X7S	22μF	±10%	GCG32EC71E226KE01#			
				±20%	GCG32ER91C685KE01#			
		X8R	6.8μF	±10%	GCG32ER91C685KE01#			
				±20%	GCG32ER91C685ME01#			
			10μF	±10%	GCG32ER91C106KE01#			
				±20%	GCG32ER91C106ME01#			
6.3Vdc	X7R	47μF	±10%	GCG32ER70J476KE01#				
			±20%	GCG32ER70J476ME01#				

Part number # indicates the package specification code.

GRT Series
 GCM Series
 GC3 Series
 GCJ Series
 GCQ Series
 GCD Series
 GCE Series
 NMF Series
 KCM Series
 KC3 Series
 KCA Series
 GCB Series
 GCG Series
 ⚠Caution /Notice

⚠Caution/Notice



Target series: GRT, GCM, GC3, GCJ, GCQ, GCD, GCE, NFM, KCM, KC3, KCA, GCB, GCG

⚠Caution

Storage and Operation Conditions	148
Rating	148
1. Temperature Dependent Characteristics	148
2. Measurement of Capacitance	148
3. Applied Voltage and Applied Current	149
4. Type of Applied Voltage and Self-heating Temperature	149
5. DC Voltage and AC Voltage Characteristics	151
6. Capacitance Aging	151
7. Vibration and Shock	152
Soldering and Mounting	152
1. Mounting Position	152
2. Information before Mounting	153
3. Maintenance of the Mounting (pick and place) Machine	153
4-1. Reflow Soldering	154
4-2. Flow Soldering	155
4-3. Correction of Soldered Portion	156
5. Washing	157
6. Electrical Test on Printed Circuit Board	157
7. Printed Circuit Board Cropping	157
8. Assembly	160
9. Selection of Conductive Adhesive, Mounting Process, and Bonding Strength	161
10. Moisture Proof Process	161
11. Application	161
Other	161
1. Under Operation of Equipment	161
2. Other	161

Notice

Rating	162
1. Operating Temperature	162
2. Atmosphere Surroundings (gaseous and liquid)	162
3. Piezo-electric Phenomenon	162
Soldering and Mounting	162
1. PCB Design	162
1. Notice for Pattern Forms	162
2. Land Dimensions	163
3. Board Design	165
2. Item to be confirmed for Flow soldering	165
3. Reflow Soldering	166
4. Washing	167
5. Coating	167
Other	167
1. Transportation	167
2. Characteristics Evaluation in the Actual System	167

GRT Series

GCM Series

GC3 Series

GCJ Series

GCQ Series

GCD Series

GCE Series

NFM Series

KCM Series

KC3 Series

KCA Series

GCB Series

GCG Series

⚠Caution / Notice

⚠Caution

Storage and Operation Conditions

1. The performance of chip multilayer ceramic capacitors (henceforth just "capacitors") may be affected by the storage conditions.

Please use them promptly after delivery.

1-1. Maintain appropriate storage for the capacitors using the following conditions:

Room Temperature of +5°C to +40°C and a Relative Humidity of 20% to 70%.

High temperature and humidity conditions and/or prolonged storage may cause deterioration of the packaging materials. If more than six months have elapsed since delivery, check packaging, mounting, etc. before use.

In addition, this may cause oxidation of the electrodes.

If more than one year has elapsed since delivery, also check the solderability before use.

1-2. Corrosive gas can react with the termination (external) electrodes or lead wires of capacitors, and result in poor solderability. Do not store the capacitors in an atmosphere consisting of corrosive gas (e.g., hydrogen sulfide, sulfur dioxide, chlorine, ammonia gas etc.).

1-3. Due to moisture condensation caused by rapid humidity changes, or the photochemical change caused by direct sunlight on the terminal electrodes and/or the resin/epoxy coatings, the solderability and electrical performance may deteriorate. Do not store capacitors under direct sunlight or in high humidity conditions

<Applicable to GCG Series>

1-4. After unpacking, immediately reseal, or store in a desiccator containing a desiccant.

Rating

1. Temperature Dependent Characteristics

1. The electrical characteristics of a capacitor can change with temperature.

1-1. For capacitors having larger temperature dependency, the capacitance may change with temperature changes.

The following actions are recommended in order to ensure suitable capacitance values.

(1) Select a suitable capacitance for the operating temperature range.

(2) The capacitance may change within the rated temperature.

When you use a high dielectric constant type capacitor in a circuit that needs a tight (narrow) capacitance tolerance (e.g., a time-constant circuit), please carefully consider the temperature characteristics, and carefully confirm the various characteristics in actual use conditions and the actual system.

[Example of Temperature Characteristics X7R(R7)]

Sample: 0.1μF, Rated Voltage 50VDC

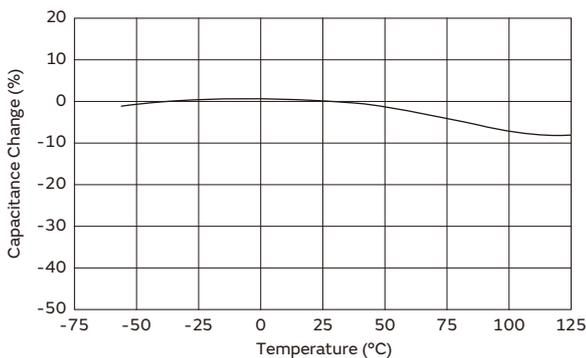

[Example of Temperature Characteristics X5R (R6)]

Sample: 22μF, Rated Voltage 4VDC

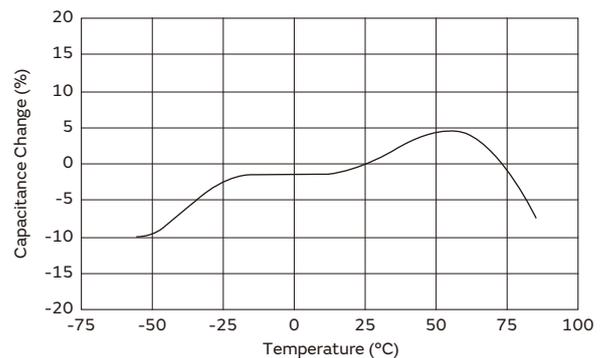

2. Measurement of Capacitance

1. Measure capacitance with the voltage and frequency specified in the product specifications.

1-1. The output voltage of the measuring equipment may decrease occasionally when capacitance is high. Please confirm whether a prescribed measured voltage is impressed to the capacitor.

1-2. The capacitance values of high dielectric constant type capacitors change depending on the AC voltage applied. Please consider the AC voltage characteristics when selecting a capacitor to be used in an AC circuit.

Continued on the following page. ↗

△Caution

Continued from the preceding page. ↘

3. Applied Voltage and Applied Current

1. Do not apply a voltage to the capacitor that exceeds the rated voltage as called out in the specifications.
 - 1-1. Applied voltage between the terminals of a capacitor shall be less than or equal to the rated voltage.
 - (1) When AC voltage is superimposed on DC voltage, the zero-to-peak voltage shall not exceed the rated DC voltage.
 When AC voltage or pulse voltage is applied, the peak-to-peak voltage shall not exceed the rated DC voltage.
 - (2) Abnormal voltages (surge voltage, static electricity, pulse voltage, etc.) shall not exceed the rated DC voltage.

Typical Voltage Applied to the DC Capacitor

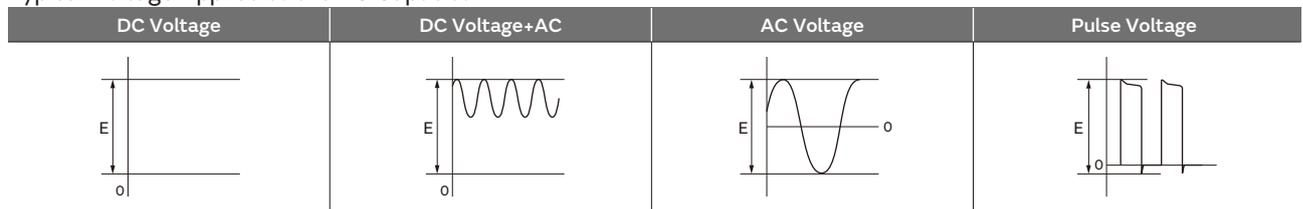

(E: Maximum possible applied voltage.)

- 1-2. Influence of over voltage

Over voltage that is applied to the capacitor may result in an electrical short circuit caused by the breakdown of the internal dielectric layers. The time duration until breakdown depends on the applied voltage and the ambient temperature.
2. Use a safety standard certified capacitor in a power supply input circuit (AC filter), as it is also necessary to consider the withstand voltage and impulse withstand voltage defined for each device.

4. Type of Applied Voltage and Self-heating Temperature

1. Confirm the operating conditions to make sure that no large current is flowing into the capacitor due to the continuous application of an AC voltage or pulse voltage.

When a DC rated voltage product is used in an AC voltage circuit or a pulse voltage circuit, the AC current or pulse current will flow into the capacitor; therefore check the self-heating condition.

Please confirm the surface temperature of the capacitor so that the temperature remains within the upper limits of the operating temperature, including the rise in temperature due to self-heating. When the capacitor is used with a high-frequency voltage or pulse voltage, heat may be generated by dielectric loss.

<Applicable to Rated Voltage of less than 100VDC>

 - 1-1. The load should be contained so that the self-heating of the capacitor body remains below 20°C, when measuring at an ambient temperature of 25°C.

<Applicable to NFM Series>

3. The capacitors also have rated currents.

The current flowing between the terminals of a capacitor shall be less than or equal to the rated current. Using the capacitor beyond this range could lead to excessive heat.

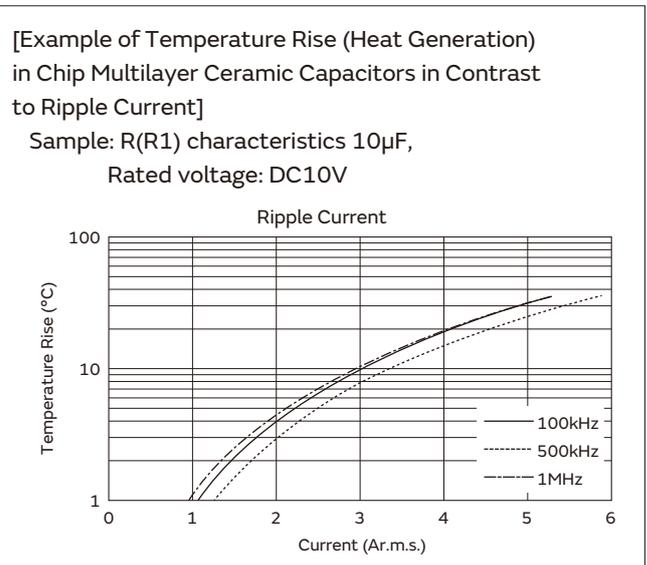

Continued on the following page. ↗

⚠Caution

Continued from the preceding page. ↘

<Applicable to Temperature Characteristics X7R(R7), X7T(D7) beyond Rated Voltage of 250VDC>

1-2. The load should be contained so that the self-heating of the capacitor body remains below 20°C, when measuring at an ambient temperature of 25°C. In addition, use a K thermocouple of $\varnothing 0.1\text{mm}$ with less heat capacity when measuring, and measure in a condition where there is no effect from the radiant heat of other components or air flow caused by convection. Excessive generation of heat may cause deterioration of the characteristics and reliability of the capacitor. (Absolutely do not perform measurements while the cooling fan is operating, as an accurate measurement may not be performed.)

<Applicable to Temperature Characteristics U2J(7U), COG(5C) beyond Rated Voltage of 250VDC>

1-3. Since the self-heating is low in the low loss series, the allowable power becomes extremely high compared to the common X7R(R7) characteristics. However, when a load with self-heating of 20°C is applied at the rated voltage, the allowable power may be exceeded. When the capacitor is used in a high-frequency voltage circuit of 1kHz or more, the frequency of the applied voltage should be less than 500kHz sine wave (less than 100kHz for a product with rated voltage of DC3.15kV), to limit the voltage load so that the load remains within the derating shown in the following figure. In the case of non-sine wave, high-frequency components exceeding the fundamental frequency may be included. In such a case, please contact Murata. The excessive generation of heat may cause deterioration of the characteristics and reliability of the capacitor. (Absolutely do not perform measurements while the cooling fan is operating, as an accurate measurement may not be performed.)

[Sine-wave frequency VS allowable voltage]

The surface temperature of the capacitor: 125°C or less (including self-heating)

COG (5C) char., Rated Voltage: DC250V
 Chip (L×W): 3.2×1.6mm

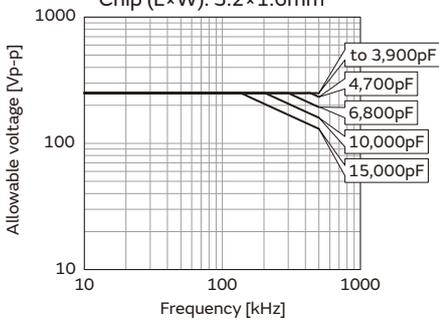

COG char., Rated Voltage: DC630V
 Chip (L×W): 3.2×1.6mm

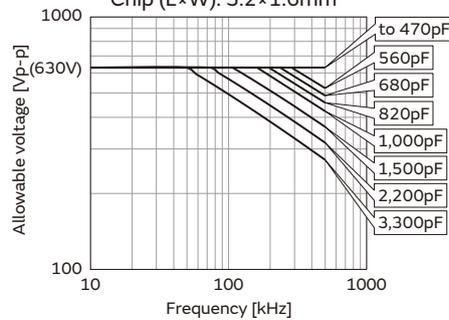

COG char., Rated Voltage: DC1kV
 Chip (L×W): 3.2×1.6mm

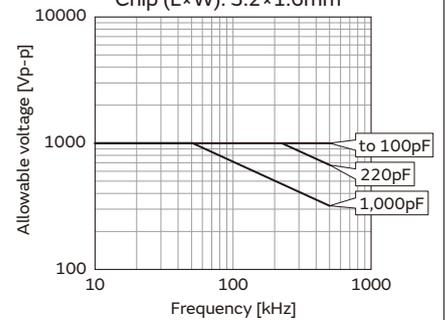

U2J(7U) char., Rated Voltage: DC250V
 Chip (L×W): 2.0×1.25mm, 3.2×1.6mm

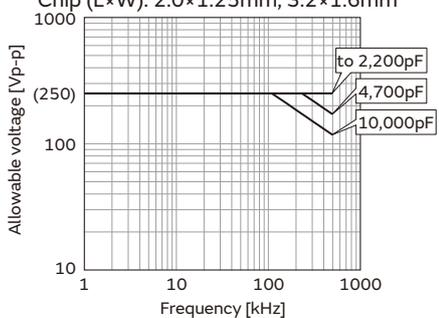

U2J(7U) char., Rated Voltage: DC630V
 Chip (L×W): 3.2×1.6mm, 3.2×2.5mm

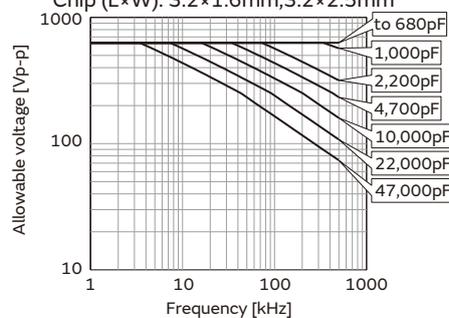

U2J(7U) char., Rated Voltage: DC1kV
 Chip (L×W): 3.2×1.6mm, 3.2×2.5mm

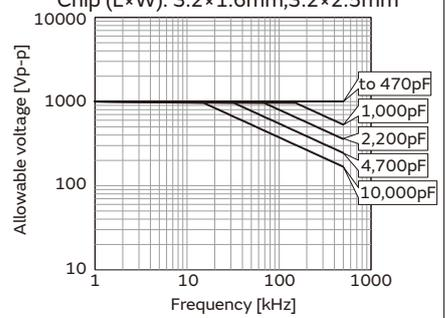

Continued on the following page. ↗

GRT Series
 GCM Series
 GC3 Series
 GCJ Series
 GCQ Series
 GCD Series
 GCE Series
 NMF Series
 KCM Series
 KC3 Series
 KCA Series
 GCB Series
 GCG Series

⚠Caution

⚠Caution

Continued from the preceding page. ↘

5. DC Voltage and AC Voltage Characteristics

1. The capacitance value of a high dielectric constant type capacitor changes depending on the DC voltage applied. Please consider the DC voltage characteristics when a capacitor is selected for use in a DC circuit.

1-1. The capacitance of ceramic capacitors may change sharply depending on the applied voltage (see figure). Please confirm the following in order to secure the capacitance.

- (1) Determine whether the capacitance change caused by the applied voltage is within the allowed range.
- (2) In the DC voltage characteristics, the rate of capacitance change becomes larger as voltage increases, even if the applied voltage is below the rated voltage. When a high dielectric constant type capacitor is used in a circuit that requires a tight (narrow) capacitance tolerance (e.g., a time constant circuit), please carefully consider the voltage characteristics, and confirm the various characteristics in the actual operating conditions of the system.

2. The capacitance values of high dielectric constant type capacitors changes depending on the AC voltage applied. Please consider the AC voltage characteristics when selecting a capacitor to be used in an AC circuit.

[Example of DC Voltage Characteristics]

Sample: R(R1) Characteristics 0.1μF,
 Rated Voltage 50VDC

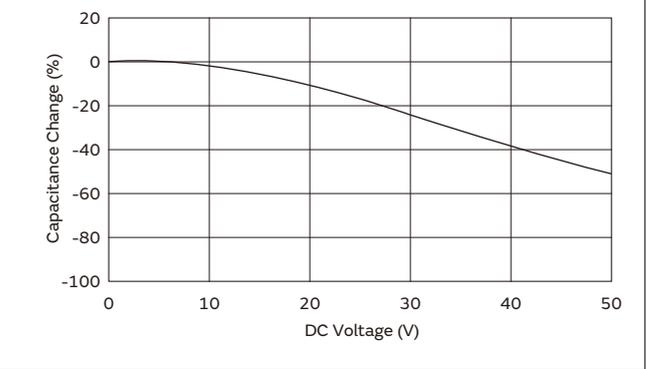

[Example of AC Voltage Characteristics]

Sample: X7R(R7) Characteristics 10μF,
 Rated Voltage 6.3VDC

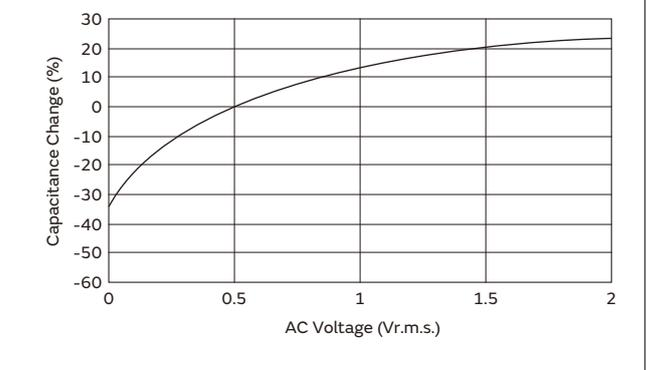

6. Capacitance Aging

1. The high dielectric constant type capacitors have the Characteristics in which the capacitance value decreases with the passage of time.

When you use high dielectric constant type capacitors in a circuit that needs a tight (narrow) capacitance tolerance (e.g., a time-constant circuit), please carefully consider the characteristics of these capacitors, such as their aging, voltage, and temperature characteristics. In addition, check capacitors using your actual appliances at the intended environment and operating conditions.

[Example of Change Over Time (Aging Characteristics)]

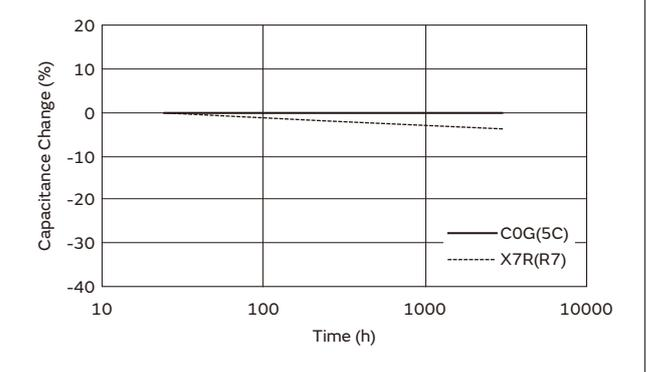

Continued on the following page. ↗

GRT Series
 GCM Series
 GC3 Series
 GCJ Series
 GCQ Series
 GCD Series
 GCE Series
 NMF Series
 KCM Series
 KC3 Series
 KCA Series
 GCB Series
 GCG Series
 ⚠Caution

⚠Caution

Continued from the preceding page. ↘

7. Vibration and Shock

1. Please confirm the kind of vibration and/or shock, its condition, and any generation of resonance.
 Please mount the capacitor so as not to generate resonance, and do not allow any impact on the terminals.
2. Mechanical shock due to being dropped may cause damage or a crack in the dielectric material of the capacitor.
 Do not use a dropped capacitor because the quality and reliability may be deteriorated.
3. When printed circuit boards are piled up or handled, the corner of another printed circuit board should not be allowed to hit the capacitor, in order to avoid a crack or other damage to the capacitor.

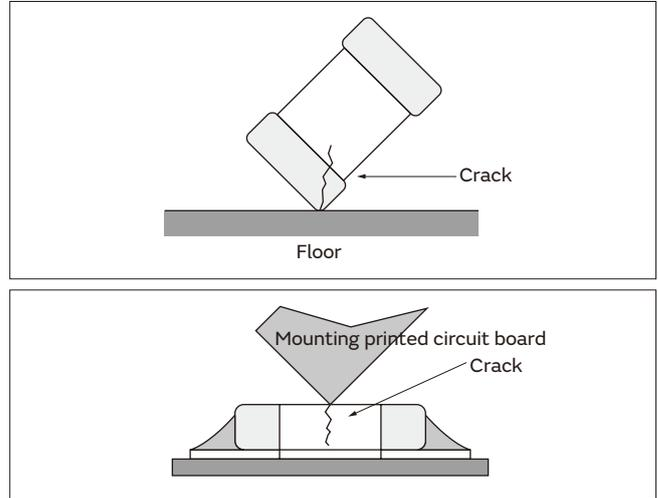

Soldering and Mounting

1. Mounting Position

1. Confirm the best mounting position and direction that minimizes the stress imposed on the capacitor during flexing or bending the printed circuit board.
 - 1-1. Choose a mounting position that minimizes the stress imposed on the chip during flexing or bending of the board.

<Applicable to NFM Series>

2. If you mount the capacitor near components that generate heat, take note of the heat from the other components and carefully check the self-heating of the capacitor before using.
 If there is significant heat radiation from other components, it could lower the insulation resistance of the capacitor or produce excessive heat.

[Component Direction]

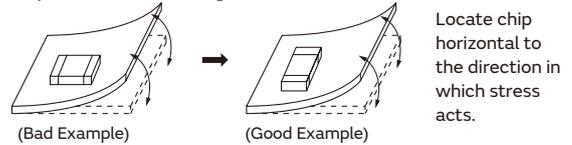

[Chip Mounting Close to Board Separation Point]

It is effective to implement the following measures, to reduce stress in separating the board.
 It is best to implement all of the following three measures; however, implement as many measures as possible to reduce stress.

Contents of Measures	Stress Level
(1) Turn the mounting direction of the component parallel to the board separation surface.	A > D *1
(2) Add slits in the board separation part.	A > B
(3) Keep the mounting position of the component away from the board separation surface.	A > C

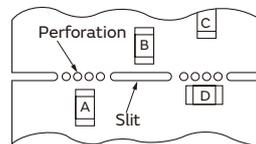

*1 A > D is valid when stress is added vertically to the perforation as with Hand Separation.
 If a Cutting Disc is used, stress will be diagonal to the PCB, therefore A > D is invalid.

[Mounting Capacitors Near Screw Holes]

When a capacitor is mounted near a screw hole, it may be affected by the board deflection that occurs during the tightening of the screw. Mount the capacitor in a position as far away from the screw holes as possible.

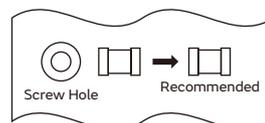

Continued on the following page. ↗

△Caution

Continued from the preceding page. ↘

2. Information before Mounting

1. Do not re-use capacitors that were removed from the equipment.
2. Confirm capacitance characteristics under actual applied voltage.
3. Confirm the mechanical stress under actual process and equipment use.
4. Confirm the rated capacitance, rated voltage and other electrical characteristics before assembly.
5. Prior to use, confirm the solderability of capacitors that were in long-term storage.
6. Prior to measuring capacitance, carry out a heat treatment for capacitors that were in long-term storage.
7. The use of Sn-Zn based solder will deteriorate the reliability of the MLCC.
Please contact our sales representative or product engineers on the use of Sn-Zn based solder in advance.

8. We have also produced a DVD which shows a summary of our recommendations, regarding the precautions for mounting. Please contact our sales representative to request the DVD.

3. Maintenance of the Mounting (pick and place) Machine

1. Make sure that the following excessive forces are not applied to the capacitors. Check the mounting in the actual device under actual use conditions ahead of time.
 - 1-1. In mounting the capacitors on the printed circuit board, any bending force against them shall be kept to a minimum to prevent them from any damage or cracking. Please take into account the following precautions and recommendations for use in your process.
 - (1) Adjust the lowest position of the pickup nozzle so as not to bend the printed circuit board.
2. Dirt particles and dust accumulated in the suction nozzle and suction mechanism prevent the nozzle from moving smoothly. This creates excessive force on the capacitor during mounting, causing cracked chips. Also, the locating claw, when worn out, imposes uneven forces on the chip when positioning, causing cracked chips. The suction nozzle and the locating claw must be maintained, checked, and replaced periodically.

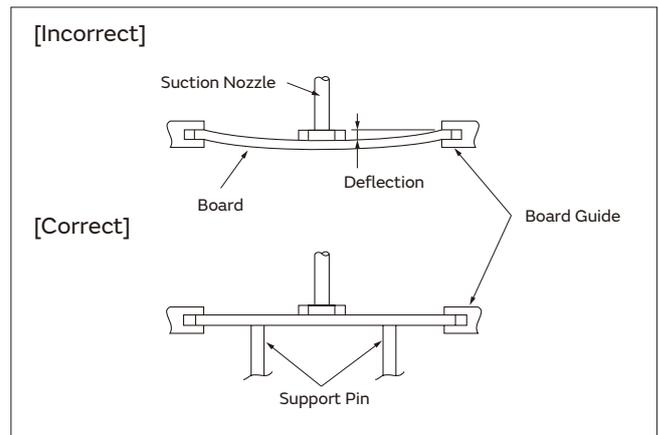

Continued on the following page. ↗

⚠Caution

Continued from the preceding page. ↘

4-1. Reflow Soldering

- When sudden heat is applied to the components, the mechanical strength of the components will decrease because a sudden temperature change causes deformation inside the components. In order to prevent mechanical damage to the components, preheating is required for both the components and the PCB. Preheating conditions are shown in table 1. It is required to keep the temperature differential between the solder and the components surface (ΔT) as small as possible.
- When components are immersed in solvent after mounting, be sure to maintain the temperature difference (ΔT) between the component and the solvent within the range shown in table 1.

Table 1

Series	Chip Dimension Code (L/W)	Temperature Differential
GRT/GCM/GC3/GCD/GCE/GCJ/NFM	03/15/18/21/31	$\Delta T \leq 190^\circ\text{C}$
GRT/GCM/GCJ	32/43/55	$\Delta T \leq 130^\circ\text{C}$
KCM/KC3/KCA	55	

Recommended Conditions

	Pb-Sn Solder	Lead Free Solder
Peak Temperature	230 to 250°C	240 to 260°C
Atmosphere	Air	Air or N ₂

Pb-Sn Solder: Sn-37Pb
 Lead Free Solder: Sn-3.0Ag-0.5Cu

- When a capacitor is mounted at a temperature lower than the peak reflow temperature recommended by the solder manufacturer, the following quality problems can occur. Consider factors such as the placement of peripheral components and the reflow temperature setting to prevent the capacitor's reflow temperature from dropping below the peak temperature specified. Be sure to evaluate the mounting situation beforehand and verify that none of the following problems occur.

- Drop in solder wettability
- Solder voids
- Possible occurrence of whiskering
- Drop in bonding strength
- Drop in self-alignment properties
- Possible occurrence of tombstones and/or shifting on the land patterns of the circuit board

4. Optimum Solder Amount for Reflow Soldering

- Overly thick application of solder paste results in an excessive solder fillet height. This makes the chip more susceptible to mechanical and thermal stress on the board and may cause the chips to crack.

Inverting the PCB

Make sure not to impose any abnormal mechanical shocks to the PCB.

[Example of Temperature Conditions for Reflow Soldering]

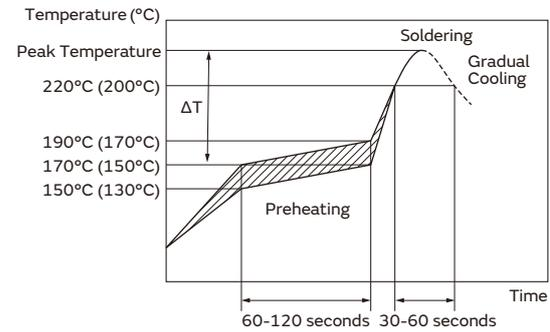

Temperature
 Incase of Lead Free Solder
 (): In case of Pb-Sn Solder

[Allowable Reflow Soldering Temperature and Time]

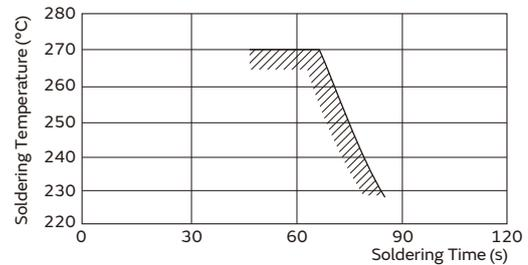

In the case of repeated soldering, the accumulated soldering time must be within the range shown above.

- Too little solder paste results in a lack of adhesive strength on the termination, which may result in chips breaking loose from the PCB.
- Please confirm that solder has been applied smoothly to the termination.

<Applicable to NFM Series>

[Guideline of solder paste thickness]

100-150μm: NFM21HC/31HK

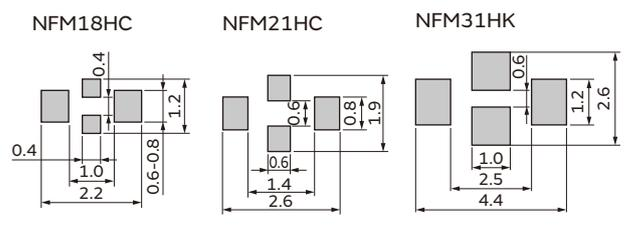

Continued on the following page. ↗

GRT Series
 GCM Series
 GC3 Series
 GCJ Series
 GCQ Series
 GCD Series
 GCE Series
 NFM Series
 KCM Series
 KC3 Series
 KCA Series
 GCB Series
 GCG Series
 ⚠Caution

⚠Caution

Continued from the preceding page. ↘

4-2. Flow Soldering

1. Do not apply flow soldering to chips not listed in table 2.

Table 2

Series	Chip Dimension Code (L/W)	Temperature Differential
GRT/GCM/GC3/GCD (Except for characteristics of X8L(L8), X8G(5G), CHA(0C), X8R(R9))	18/21/31	$\Delta T \leq 150^\circ\text{C}$
GCJ (Rated Voltage 250VDC or more)		
NFM		

- When sudden heat is applied to the components, the mechanical strength of the components will decrease because a sudden temperature change causes deformation inside the components. In order to prevent mechanical damage to the components, preheating is required for both of the components and the PCB. Preheating conditions are shown in table 2. It is required to keep the temperature differential between the solder and the components surface (ΔT) as low as possible.
- Excessively long soldering time or high soldering temperature can result in leaching of the terminations, causing poor adhesion or a reduction in capacitance value due to loss of contact between the inner electrodes and terminations.
- When components are immersed in solvent after mounting, be sure to maintain the temperature differential (ΔT) between the component and solvent within the range shown in the table 2.

Recommended Conditions

	Pb-Sn Solder	Lead Free Solder
Preheating Peak Temperature	90 to 110°C	100 to 120°C 140 to 160°C (NFM)
Soldering Peak Temperature	240 to 250°C	250 to 260°C
Atmosphere	Air	Air or N ₂

Pb-Sn Solder: Sn-37Pb

Lead Free Solder: Sn-3.0Ag-0.5Cu

5. Optimum Solder Amount for Flow Soldering

5-1. The top of the solder fillet should be lower than the thickness of the components. If the solder amount is excessive, the risk of cracking is higher during board bending or any other stressful condition.

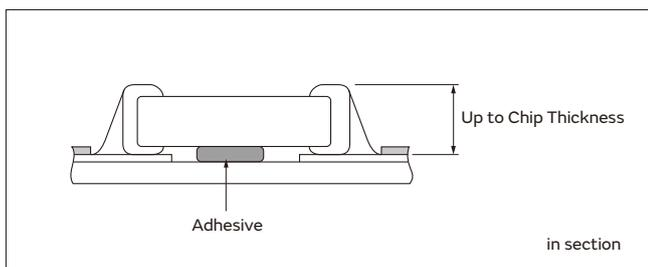

[Example of Temperature Conditions for Flow Soldering]

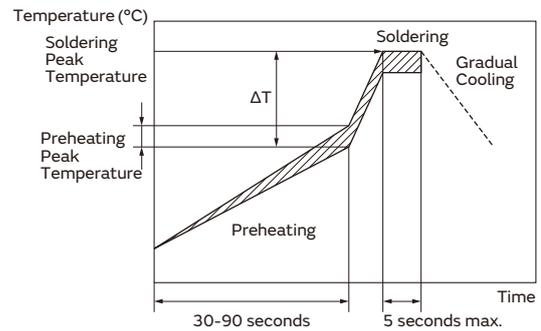

[Allowable Flow Soldering Temperature and Time]

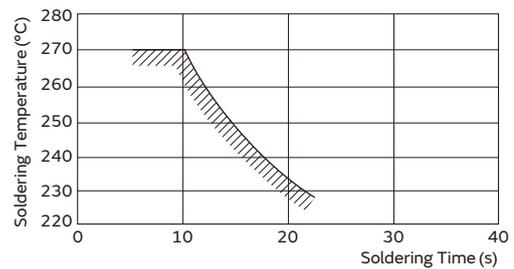

In the case of repeated soldering, the accumulated soldering time must be within the range shown above.

Continued on the following page. ↗

GRT Series
 GCM Series
 GC3 Series
 GCJ Series
 GCQ Series
 GCD Series
 GCE Series
 NMF Series
 KCM Series
 KC3 Series
 KCA Series
 GCB Series
 GCG Series
 ⚠Caution

⚠Caution

Continued from the preceding page. ↘

4-3. Correction of Soldered Portion

When sudden heat is applied to the capacitor, distortion caused by the large temperature difference occurs internally, and can be the cause of cracks. Capacitors also tend to be affected by mechanical and thermal stress depending on the board preheating temperature or the soldering fillet shape, and can be the cause of cracks. Please refer to "1. PCB Design" or "3. Optimum solder amount" for the solder amount and the fillet shapes.

1. Correction with a Soldering Iron

- 1-1. In order to reduce damage to the capacitor, be sure to preheat the capacitor and the mounting board. Preheat to the temperature range shown in Table 3. A hot plate, hot air type preheater, etc. can be used for preheating.

- 1-2. After soldering, do not allow the component/PCB to cool down rapidly.
- 1-3. Perform the corrections with a soldering iron as quickly as possible. If the soldering iron is applied too long, there is a possibility of causing solder leaching on the terminal electrodes, which will cause deterioration of the adhesive strength and other problems.

Table 3

Series	Chip Dimension Code (L/W)	Temperature of Soldering Iron Tip	Preheating Temperature	Temperature Differential (ΔT)	Atmosphere
GRT/GCM/GC3/GCD/GCE/GCJ	03/15/18/21/31	350°C max.	150°C min.	$\Delta T \leq 190^\circ\text{C}$	Air
GRT/GCM/GCJ	32/43/55	280°C max.	150°C min.	$\Delta T \leq 130^\circ\text{C}$	Air
NFM	21/31	350°C max.	150°C min.	$\Delta T \leq 190^\circ\text{C}$	Air

*Applicable for both Pb-Sn and Lead Free Solder.
 Pb-Sn Solder: Sn-37Pb
 Lead Free Solder: Sn-3.0Ag-0.5Cu
 *Please manage ΔT in the temperature of soldering iron and the preheating temperature.

2. Correction with Spot Heater

Compared to local heating with a soldering iron, hot air heating by a spot heater heats the overall component and board, therefore, it tends to lessen the thermal shock. In the case of a high density mounted board, a spot heater can also prevent concerns of the soldering iron making direct contact with the component.

- 2-1. If the distance from the hot air outlet of the spot heater to the component is too close, cracks may occur due to thermal shock. To prevent this problem, follow the conditions shown in Table 4.

Table 4

Distance	5mm or more
Hot Air Application Angle	45° *Figure 1
Hot Air Temperature Nozzle Outlet	400°C max.
Application Time	Less than 10 seconds (1206 (3216M) size or smaller)
	Less than 30 seconds (1210 (3225M) size or larger)

- 2-2. In order to create an appropriate solder fillet shape, it is recommended that hot air be applied at the angle shown in Figure 1.

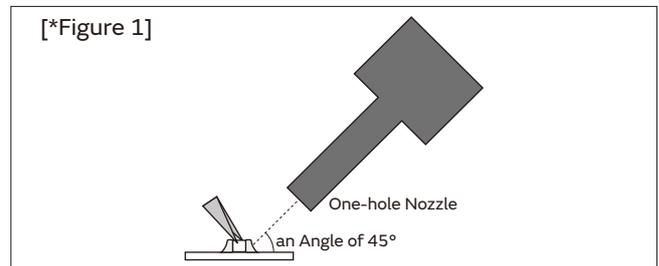

3. Optimum solder amount when re-working with a soldering iron

- 3-1. If the solder amount is excessive, the risk of cracking is higher during board bending or any other stressful condition.

Too little solder amount results in a lack of adhesive strength on the outer electrode termination, which may result in chips breaking loose from the PCB. Please confirm that solder has been applied smoothly is and rising to the end surface of the chip.

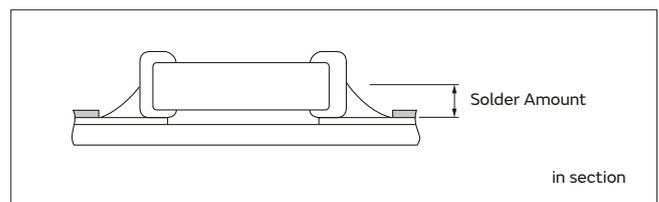

Continued on the following page. ↗

⚠Caution

Continued from the preceding page. ↘

- 3-2. A soldering iron with a tip of $\varnothing 3\text{mm}$ or smaller should be used. It is also necessary to keep the soldering iron from touching the components during the re-work.
- 3-3. Solder wire with $\varnothing 0.5\text{mm}$ or smaller is required for soldering.

<Applicable to KCM/KC3/KCA Series>

4. For the shape of the soldering iron tip, refer to the figure on the right.

Regarding the type of solder, use a wire diameter of $\varnothing 0.5\text{mm}$ or less (rosin core wire solder).

4-1. How to Apply the Soldering Iron

Apply the tip of the soldering iron against the lower end of the metal terminal.

- 1) In order to prevent cracking caused by sudden heating of the ceramic device, do not touch the ceramic base directly.
- 2) In order to prevent deviations and dislocating of the chip, do not touch the junction of the chip and the metal terminal, and the metal portion on the outside directly.

4-2. Appropriate Amount of Solder

The amount of solder for corrections by soldering iron, should be lower than the height of the lower side of the chip.

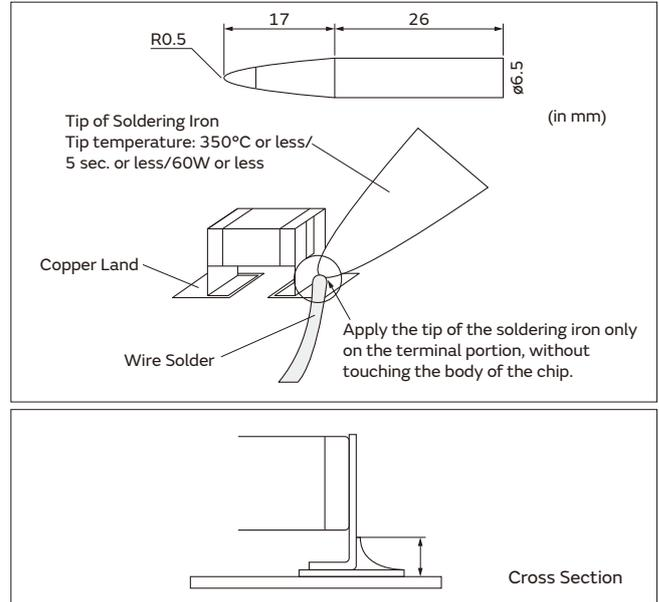

5. Washing

Excessive ultrasonic oscillation during cleaning can cause the PCBs to resonate, resulting in cracked chips or broken solder joints. Before starting your production process, test your cleaning equipment/process to insure it does not degrade the capacitors.

6. Electrical Test on Printed Circuit Board

1. Confirm position of the support pin or specific jig, when inspecting the electrical performance of a capacitor after mounting on the printed circuit board.

1-1. Avoid bending the printed circuit board by the pressure of a test-probe, etc.

The thrusting force of the test probe can flex the PCB, resulting in cracked chips or open solder joints. Provide support pins on the back side of the PCB to prevent warping or flexing. Install support pins as close to the test-probe as possible.

1-2. Avoid vibration of the board by shock when a test-probe contacts a printed circuit board.

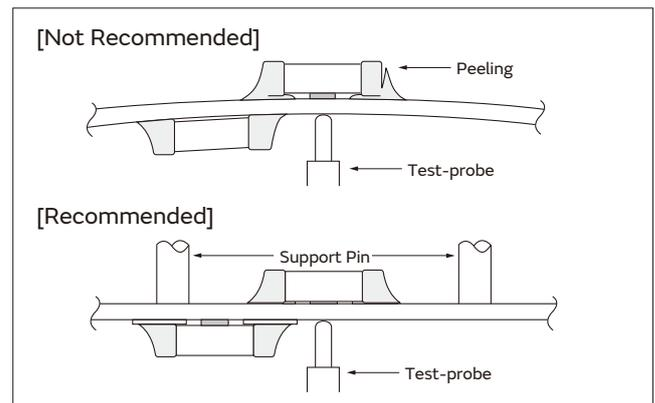

7. Printed Circuit Board Cropping

1. After mounting a capacitor on a printed circuit board, do not apply any stress to the capacitor that causes bending or twisting the board.

1-1. In cropping the board, the stress as shown at right may cause the capacitor to crack.

Avoid this type of stress to a capacitor.

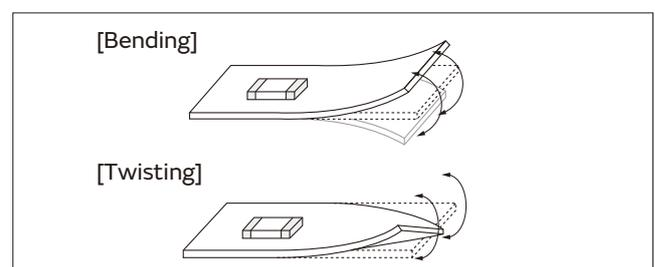

Continued on the following page. ↗

△Caution

Continued from the preceding page. ↘

2. Check the cropping method for the printed circuit board in advance.

2-1. Printed circuit board cropping shall be carried out by using a jig or an apparatus (Disc separator, router type separator, etc.) to prevent the mechanical stress that can occur to the board.

Board Separation Method	Hand Separation Nipper Separation	(1) Board Separation Jig	Board Separation Apparatus	
			(2) Disc Separator	(3) Router Type Separator
Level of stress on board	High	Medium	Medium	Low
Recommended	×	△*	△*	○
Notes	Hand and nipper separation apply a high level of stress. Use another method.	<ul style="list-style-type: none"> Board handling Board bending direction Layout of capacitors 	<ul style="list-style-type: none"> Board handling Layout of slits Design of V groove Arrangement of blades Controlling blade life 	Board handling

* When a board separation jig or disc separator is used, if the following precautions are not observed, a large board deflection stress will occur and the capacitors may crack. Use router type separator if at all possible.

(1) Example of a suitable jig

[In the case of Single-side Mounting]

An outline of the board separation jig is shown as follows. Recommended example: Stress on the component mounting position can be minimized by holding the portion close to the jig, and bend in the direction towards the side where the capacitors are mounted. Not recommended example: The risk of cracks occurring in the capacitors increases due to large stress being applied to the component mounting position, if the portion away from the jig is held and bent in the direction opposite the side where the capacitors are mounted.

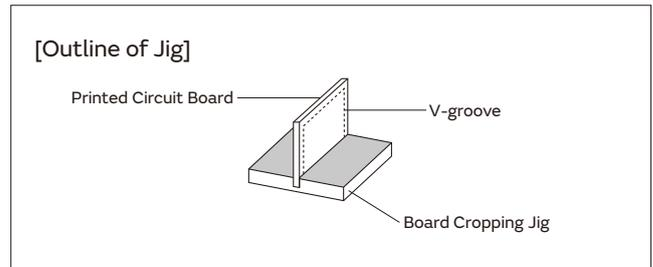

Hand Separation

Recommended	Not Recommended

[In the case of Double-sided Mounting]

Since components are mounted on both sides of the board, the risk of cracks occurring can not be avoided with the above method. Therefore, implement the following measures to prevent stress from being applied to the components.

(Measures)

- (1) Consider introducing a router type separator. If it is difficult to introduce a router type separator, implement the following measures. (Refer to item 1. Mounting Position)
- (2) Mount the components parallel to the board separation surface.
- (3) When mounting components near the board separation point, add slits in the separation position near the component.
- (4) Keep the mounting position of the components away from the board separation point.

Continued on the following page. ↗

⚠Caution

Continued from the preceding page. ↘

(2) Example of a Disc Separator

An outline of a disc separator is shown as follows. As shown in the Principle of Operation, the top blade and bottom blade are aligned with the V-grooves on the printed circuit board to separate the board.

In the following case, board deflection stress will be applied and cause cracks in the capacitors.

- (1) When the adjustment of the top and bottom blades are misaligned, such as deviating in the top-bottom, left-right or front-rear directions
- (2) The angle of the V groove is too low, depth of the V groove is too shallow, or the V groove is misaligned top-bottom

IF V groove is too deep, it is possible to brake when you handle and carry it. Carefully design depth of the V groove with consideration about strength of material of the printed circuit board.

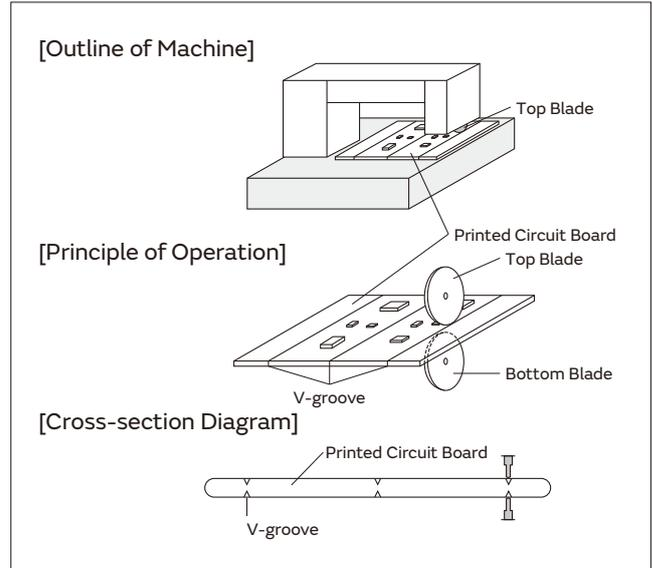

Disc Separator

Recommended	Not Recommended		
	Top-bottom Misalignment	Left-right Misalignment	Front-rear Misalignment
<p>Top Blade</p> <p>Bottom Blade</p>	<p>Top Blade</p> <p>Bottom Blade</p>	<p>Top Blade</p> <p>Bottom Blade</p>	<p>Top Blade</p> <p>Bottom Blade</p>

V-groove Design

Example of Recommended V-groove Design	Not Recommended			
	Left-right Misalignment	Low-Angle	Depth too Shallow	Depth too Deep

(3) Example of Router Type Separator

The router type separator performs cutting by a router rotating at a high speed. Since the board does not bend in the cutting process, stress on the board can be suppressed during board separation.

When attaching or removing boards to/from the router type separator, carefully handle the boards to prevent bending.

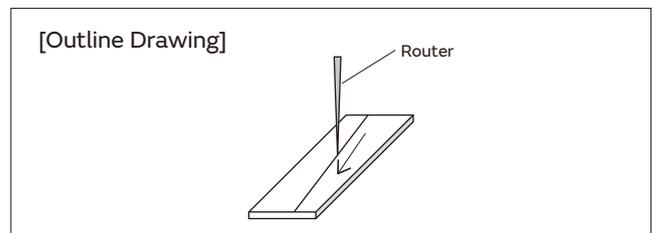

Continued on the following page. ↗

GRT Series
 GCM Series
 GC3 Series
 GCJ Series
 GCQ Series
 GCD Series
 GCE Series
 NMF Series
 KCM Series
 KC3 Series
 KCA Series
 GCB Series
 GCG Series
 ⚠Caution

⚠Caution

Continued from the preceding page. ↘

8. Assembly

1. Handling

If a board mounted with capacitors is held with one hand, the board may bend. Firmly hold the edges of the board with both hands when handling.

If a board mounted with capacitors is dropped, cracks may occur in the capacitors.

Do not use dropped boards, as there is a possibility that the quality of the capacitors may be impaired.

2. Attachment of Other Components

2-1. Mounting of Other Components

Pay attention to the following items, when mounting other components on the back side of the board after capacitors have been mounted on the opposite side. When the bottom dead point of the suction nozzle is set too low, board deflection stress may be applied to the capacitors on the back side (bottom side), and cracks may occur in the capacitors.

- After the board is straightened, set the bottom dead point of the nozzle on the upper surface of the board.
- Periodically check and adjust the bottom dead point.

2-2. Inserting Components with Leads into Boards

When inserting components (transformers, IC, etc.) into boards, bending the board may cause cracks in the capacitors or cracks in the solder.

Pay attention to the following.

- Increase the size of the holes to insert the leads, to reduce the stress on the board during insertion.
- Fix the board with support pins or a dedicated jig before insertion.
- Support below the board so that the board does not bend. When using support pins on the board, periodically confirm that there is no difference in the height of each support pin.

2-3. Attaching/Removing Sockets and/or Connectors

Insertion and removal of sockets and connectors, etc., might cause the board to bend. Please insure that the board does not warp during insertion and removal of sockets and connectors, etc., or the bending may damage mounted components on the board.

2-4. Tightening Screws

The board may be bent, when tightening screws, etc. during the attachment of the board to a shield or chassis.

Pay attention to the following items before performing the work.

- Plan the work to prevent the board from bending.
- Use a torque screwdriver, to prevent over-tightening of the screws.
- The board may bend after mounting by reflow soldering, etc. Please note, as stress may be applied to the chips by forcibly flattening the board when tightening the screws.

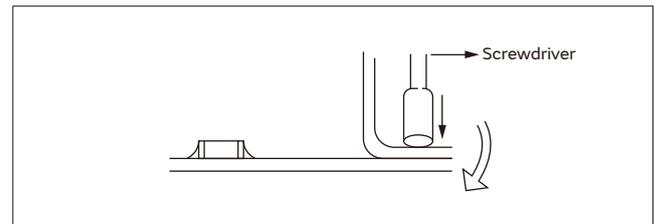
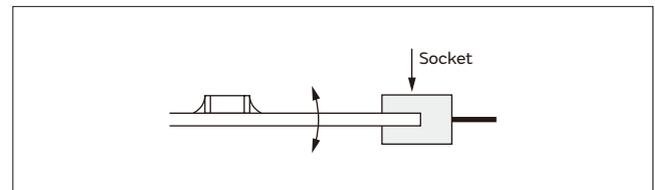
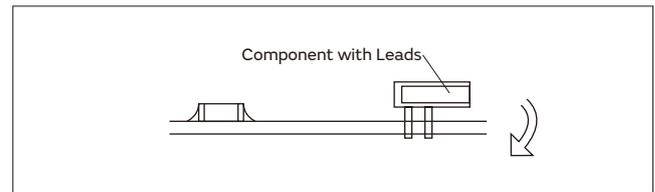
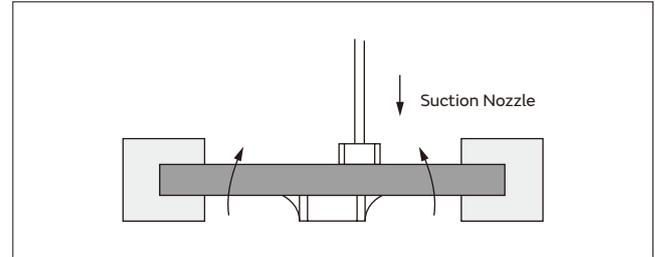

Continued on the following page. ↗

⚠Caution

Continued from the preceding page. ↘

<Applicable to GCG Series>

9. Selection of Conductive Adhesive, Mounting Process, and Bonding Strength

The acquired bonding strength may change greatly depending on the conductive adhesive to be used.

Be sure to confirm if the desired performance can be acquired in the assumed mounting process with the conductive adhesive to be used.

Other

1. Under Operation of Equipment

- 1-1. Do not touch a capacitor directly with bare hands during operation in order to avoid the danger of an electric shock.
- 1-2. Do not allow the terminals of a capacitor to come in contact with any conductive objects (short-circuit). Do not expose a capacitor to a conductive liquid, including any acid or alkali solutions.
- 1-3. Confirm the environment in which the equipment will operate is under the specified conditions. Do not use the equipment under the following environments.
 - (1) Being splattered with water or oil.
 - (2) Being exposed to direct sunlight.
 - (3) Being exposed to ozone, ultraviolet rays, or radiation.
 - (4) Being exposed to toxic gas (e.g., hydrogen sulfide, sulfur dioxide, chlorine, ammonia gas, etc.)
 - (5) Any vibrations or mechanical shocks exceeding the specified limits.
 - (6) Moisture condensing environments.
- 1-4. Use damp proof countermeasures if using under any conditions that can cause condensation.

2. Other

- 2-1. In an Emergency
 - (1) If the equipment should generate smoke, fire, or smell, immediately turn off or unplug the equipment.
If the equipment is not turned off or unplugged, the hazards may be worsened by supplying continuous power.
 - (2) In this type of situation, do not allow face and hands to come in contact with the capacitor or burns may be caused by the capacitor's high temperature.
- 2-2. Disposal of Waste
When capacitors are disposed of, they must be burned or buried by an industrial waste vendor with the appropriate licenses.
- 2-3. Circuit Design
 - (1) Addition of Fail Safe Function
Capacitors that are cracked by dropping or bending of the board may cause deterioration of the insulation resistance, and result in a short.

10. Moisture Proof Process

In order to prevent the occurrence of migration, perform a moisture proof process, such as applying a resin coating or enclosing with a dry inert gas.

11. Application

This product is limited to conductive glue mounting. When performing solder mounting, contact Murata in advance.

If the circuit being used may cause an electrical shock, smoke or fire when a capacitor is shorted, be sure to install fail-safe functions, such as a fuse, to prevent secondary accidents.

- (2) Capacitors used to prevent electromagnetic interference in the primary AC side circuit, or as a connection/insulation, must be a safety standard certified product, or satisfy the contents stipulated in the Electrical Appliance and Material Safety Law. Install a fuse for each line in case of a short.
- (3) The GC3, GCD, GCE, GCG, GCJ, GCM, KC3, KCM, and NFM series are not safety standard certified products.

2-4. Test Condition for AC Withstanding Voltage

- (1) Test Equipment
Test equipment for AC withstanding voltage should be made with equipment capable of creating a wave similar to a 50/60Hz sine wave.
- (2) Voltage Applied Method
The capacitor's lead or terminal should be firmly connected to the output of the withstanding voltage test equipment, and then the voltage should be raised from near zero to the test voltage.

If the test voltage is applied directly to the capacitor without raising it from near zero, it should be applied with the zero cross. *At the end of the test time, the test voltage should be reduced to near zero, and then capacitor's lead or terminals should be taken off the output of the withstanding voltage test equipment.
If the test voltage applied directly to the capacitor without raising it from near zero, surge voltage may occur and cause a defect.

*ZERO CROSS is the point where voltage sine wave passes 0V. - See the figure at right -

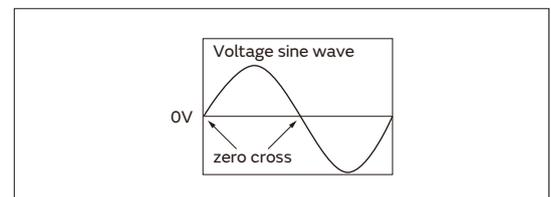

Continued on the following page. ↗

Notice

Continued from the preceding page. ↘

2-5. Remarks

Failure to follow the cautions may result, worst case, in a short circuit and smoking when the product is used.

The above notices are for standard applications and conditions. Contact us when the products are used in special mounting conditions.

Select optimum conditions for operation as they determine the reliability of the product after assembly.

The data herein are given in typical values, not guaranteed ratings.

Rating

1. Operating Temperature

1. The operating temperature limit depends on the capacitor.

1-1. Do not apply temperatures exceeding the upper operating temperature.

It is necessary to select a capacitor with a suitable rated temperature that will cover the operating temperature range.

It is also necessary to consider the temperature distribution in equipment and the seasonal temperature variable factor.

1-2. Consider the self-heating factor of the capacitor.

The surface temperature of the capacitor shall not exceed the maximum operating temperature including self-heating.

2. Atmosphere Surroundings (gaseous and liquid)

1. Restriction on the operating environment of capacitors.

1-1. Capacitors, when used in the above, unsuitable, operating environments may deteriorate due to the corrosion of the terminations and the penetration of moisture into the capacitor.

1-2. The same phenomenon as the above may occur when the electrodes or terminals of the capacitor are subject to moisture condensation.

1-3. The deterioration of characteristics and insulation resistance due to the oxidization or corrosion of terminal electrodes may result in breakdown when the capacitor is exposed to corrosive or volatile gases or solvents for long periods of time.

3. Piezo-electric Phenomenon

1. When using high dielectric constant type capacitors in AC or pulse circuits, the capacitor itself vibrates at specific frequencies and noise may be generated.

Moreover, when the mechanical vibration or shock is added to the capacitor, noise may occur.

Soldering and Mounting

1. PCB Design

1. Notice for Pattern Forms

1-1. Unlike leaded components, chip components are susceptible to flexing stresses since they are mounted directly on the substrate.

They are also more sensitive to mechanical and thermal stresses than leaded components.

Excess solder fillet height can multiply these stresses and cause chip cracking. When designing substrates, take land patterns and dimensions into consideration to eliminate the possibility of excess solder fillet height.

1-2. There is a possibility of chip cracking caused by PCB expansion/contraction with heat, because stress on a chip is different depending on PCB material and structure. When the thermal expansion coefficient greatly differs between the board used for mounting and the chip, it will cause cracking of the chip due to the thermal expansion and contraction. When capacitors are mounted on a fluorine resin printed circuit board or on a single-layered glass epoxy board, it may also cause cracking of the chip for the same reason.

1-3. If you are replacing by smaller capacitors, you should not only consider the Land size change but also consider changing the Wiring Width, Wiring direction, and copper foil thickness because the risk of chip cracking is increased with just a Land size change.

<Applicable to NFM Series>

1-4. Because noise is suppressed by shunting unwanted high-frequency components to the ground, when designing a land for the NFM series, design the ground pattern to be as large as possible in order to better bring out this characteristic.

As shown in the figure below, noise countermeasures can be made more effective by using a via to connect the ground pattern on the chip mounting surface to a larger ground pattern on the inner layer.

Continued on the following page. ↗

Notice

Continued from the preceding page. ↘

Pattern Forms

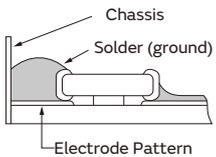
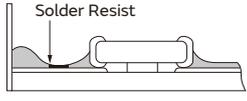
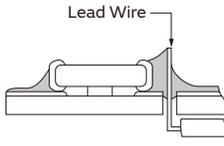
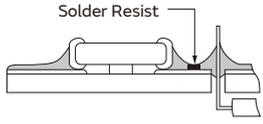
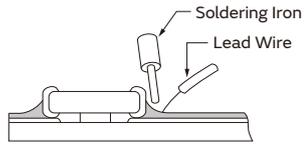
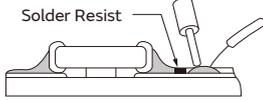
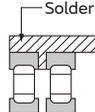
	Prohibited	Correct
Placing Close to Chassis	 <p>Chassis Solder (ground) Electrode Pattern</p> <p>in section</p>	 <p>Solder Resist</p> <p>in section</p>
Placing of Chip Components and Leaded Components	 <p>Lead Wire</p> <p>in section</p>	 <p>Solder Resist</p> <p>in section</p>
Placing of Leaded Components after Chip Component	 <p>Soldering Iron Lead Wire</p> <p>in section</p>	 <p>Solder Resist</p> <p>in section</p>
Lateral Mounting		 <p>Solder Resist</p>

2. Land Dimensions

- 2-1. Please refer to the land dimensions in table 1 for flow soldering, table 2 for reflow soldering.
 Please confirm the suitable land dimension by evaluating of the actual SET / PCB.

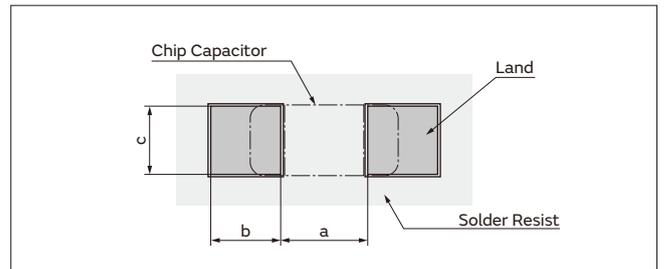

Table 1 Flow Soldering Method

Series	Chip Dimension Code (L/W)	Chip (L×W)	a	b	c
GRT/GCM/GC3/GCD/GCJ (Rated Voltage: above 250VDC (for GCJ alone))	18	1.6×0.8	0.6 to 1.0	0.8 to 0.9	0.6 to 0.8
	21	2.0×1.25	1.0 to 1.2	0.9 to 1.0	0.8 to 1.1
	31	3.2×1.6	2.2 to 2.6	1.0 to 1.1	1.0 to 1.4

Flow soldering can only be used for products with a chip size from 1.6×0.8mm to 3.2×1.6mm.

(in mm)

Table 2 Reflow Soldering Method

Series	Chip Dimension Code (L/W)	Chip (L×W)	a	b	c
GRT/GCM/GC3/ GCD/GCE/GCJ	03	0.6×0.3	0.2 to 0.3	0.2 to 0.35	0.2 to 0.4
	15	1.0×0.5 (within ±0.10)	0.3 to 0.5	0.35 to 0.45	0.4 to 0.6
		1.0×0.5 (±0.15/±0.20)	0.4 to 0.6	0.4 to 0.5	0.5 to 0.7
	18	1.6×0.8 (within ±0.10)	0.6 to 0.8	0.6 to 0.7	0.6 to 0.8
		1.6×0.8 (±0.15/±0.20)	0.7 to 0.9	0.7 to 0.8	0.8 to 1.0
	21	2.0×1.25 (within ±0.10)	1.2	0.6	1.25
		2.0×1.25 (±0.15)	1.2	0.6 to 0.8	1.2 to 1.4
		2.0×1.25 (±0.20)	1.0 to 1.4	0.6 to 0.8	1.2 to 1.4
	31	3.2×1.6 (within ±0.20)	1.8 to 2.0	0.9 to 1.2	1.5 to 1.7
		3.2×1.6 (±0.30)	1.9 to 2.1	1.0 to 1.3	1.7 to 1.9
	32	3.2×2.5	2.0 to 2.4	1.0 to 1.2	1.8 to 2.3
	43	4.5×3.2	3.0 to 3.5	1.2 to 1.4	2.3 to 3.0
	55	5.7×5.0	4.0 to 4.6	1.4 to 1.6	3.5 to 4.8

(in mm)

Continued on the following page. ↗

Notice

Continued from the preceding page. ↘

<Applicable to Part Number KCM/KC3/KCA>

Series	Chip Dimension Code (L×W)	Body Size (L×W)	a	b	c
KCM/KC3 (Except 5C)	55	6.1×5.3	2.6 to 3.2	2.4 to 2.7	5.5 to 5.6
KCM (5C only)	55	6.1×5.1	3.2 to 4.0	2.0 to 2.4	5.5 to 5.7
KCA	55	6.1×5.1	3.2 to 4.0	2.0 to 2.4	5.5 to 5.7

(in mm)

<Applicable to beyond Rated Voltage of 200VDC>

2-2. Dimensions of Slit (Example)

Preparing the slit helps flux cleaning and resin coating on the back of the capacitor.

However, the length of the slit design should be as short as possible to prevent mechanical damage in the capacitor.

A longer slit design might receive more severe mechanical stress from the PCB.

Recommended slit design is shown in the Table.

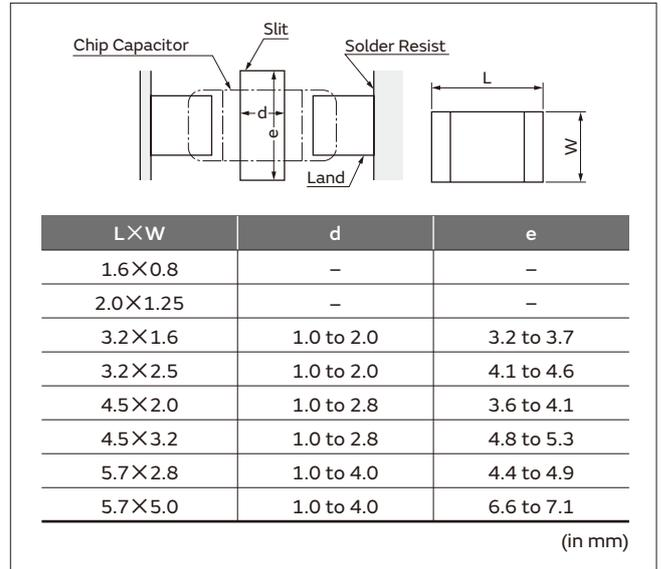

<Applicable to NFM Series>

Legend: Land Pattern + Solder Resist, Land Pattern, Solder Resist (in mm)

Series	Land Dimensions
NFM21HC	<p>● Reflow Soldering</p> <p>NFM18HC Small diameter thru hole $\phi 0.2\text{-}\phi 0.3$</p> <p>NFM21HC Small diameter thru hole $\phi 0.4$</p>
	<p>● Reflow Soldering Chip mounting side</p> <p>NFM31HK*1 Small diameter thru hole $\phi 0.4$</p> <p>10mm or more (in case of 10A)</p> <p>*1 For large current design, width of signal land pattern should be wider not less than 1mm per 1A (1mm/A). For example, in case of 10A, signal land pattern width should be 10mm or more. (1mm/A*10A=10mm)</p>
NFM31HK	<p>● Flow Soldering Chip mounting side</p> <p>NFM31HK*1 Small diameter thru hole $\phi 0.4$</p> <p>10mm or more (in case of 10A)</p> <p>*1 For large current design, width of signal land pattern should be wider not less than 1mm per 1A (1mm/A). For example, in case of 10A, signal land pattern width should be 10mm or more. (1mm/A*10A=10mm)</p>

Continued on the following page. ↗

Notice

Continued from the preceding page. ↘

3. Board Design

When designing the board, keep in mind that the amount of strain which occurs will increase depending on the size and material of the board.

[Relationship with amount of strain to the board thickness, length, width, etc.]

$$\epsilon = \frac{3PL}{2Ewh^2} \quad \text{Relationship between load and strain}$$

ϵ : Strain on center of board (μst)
 L: Distance between supporting points (mm)
 w: Board width (mm)
 h: Board thickness (mm)
 E: Elastic modulus of board ($\text{N}/\text{m}^2=\text{Pa}$)
 Y: Deflection (mm)
 P: Load (N)

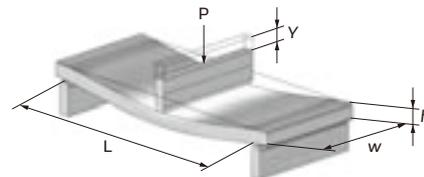

When the load is constant, the following relationship can be established.

- As the distance between the supporting points (L) increases, the amount of strain also increases.
→Reduce the distance between the supporting points.
 - As the elastic modulus (E) decreases, the amount of strain increases.
→Increase the elastic modulus.
 - As the board width (w) decreases, the amount of strain increases.
→Increase the width of the board.
 - As the board thickness (h) decreases, the amount of strain increases.
→Increase the thickness of the board.
- Since the board thickness is squared, the effect on the amount of strain becomes even greater.

2. Item to be confirmed for Flow soldering

If you want to temporarily attach the capacitor to the board using an adhesive agent before soldering the capacitor, first be sure that the conditions are appropriate for affixing the capacitor. If the dimensions of the land, the type of adhesive, the amount of coating, the contact surface area, the curing temperature, or other conditions are inappropriate, the characteristics of the capacitor may deteriorate.

1. Selection of Adhesive

1-1. Depending on the type of adhesive, there may be a decrease in insulation resistance. In addition, there is a chance that the capacitor might crack from contractile stress due to the difference in the contraction rate of the capacitor and the adhesive.

1-2. If there is not enough adhesive, the contact surface area is too small, or the curing temperature or curing time are inadequate, the adhesive strength will be insufficient and the capacitor may loosen or become disconnected during transportation or soldering. If there is too much adhesive, for example if it overflows onto the land, the result could be soldering defects, loss of electrical connection, insufficient curing, or slippage after the capacitor is mounted.

Furthermore, if the curing temperature is too high or the curing time is too long, not only will the adhesive

strength be reduced, but solderability may also suffer due to the effects of oxidation on the terminations (outer electrodes) of the capacitor and the land surface on the board.

(1) Selection of Adhesive

Epoxy resins are a typical class of adhesive.

To select the proper adhesive, consider the following points.

- 1) There must be enough adhesive strength to prevent the component from loosening or slipping during the mounting process.
- 2) The adhesive strength must not decrease when exposed to moisture during soldering.
- 3) The adhesive must have good coatability and shape retention properties.
- 4) The adhesive must have a long pot life.
- 5) The curing time must be short.
- 6) The adhesive must not be corrosive to the exterior of the capacitor or the board.
- 7) The adhesive must have good insulation properties.
- 8) The adhesive must not emit toxic gases or otherwise be harmful to health.
- 9) The adhesive must be free of halogenated compounds.

Continued on the following page. ↗

Notice

Continued from the preceding page. ↘

(2) Use the following illustration as a guide to the amount of adhesive to apply.

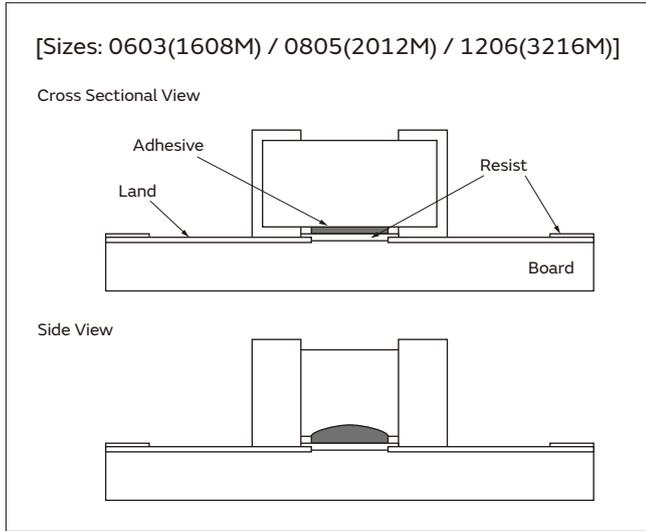

<Applicable to NFM Series>

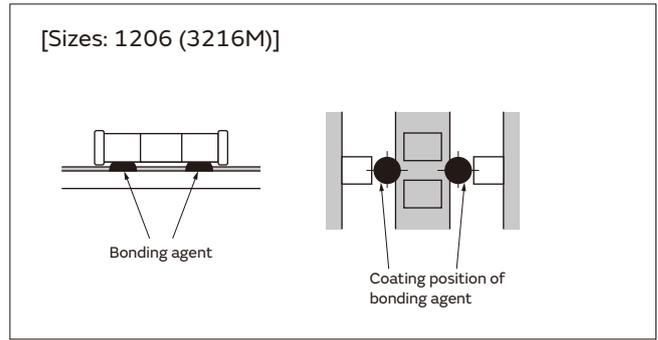

2. Flux

- 2-1. An excessive amount of flux generates a large quantity of flux gas, which can cause a deterioration of solderability, so apply flux thinly and evenly throughout. (A foaming system is generally used for flow soldering.)
- 2-2. Flux containing too high a percentage of halide may cause corrosion of the terminations unless there is sufficient cleaning. Use flux with a halide content of 0.1% max.
- 2-3. Strong acidic flux can corrode the capacitor and degrade its performance.

Please check the quality of capacitor after mounting.

3. Leaching of the terminations

- Set temperature and time to ensure that leaching of the termination does not exceed 25% of the chip end area as a single chip (full length of the edge A-B-C-D shown at right) and 25% of the length A-B shown as mounted on substrate.

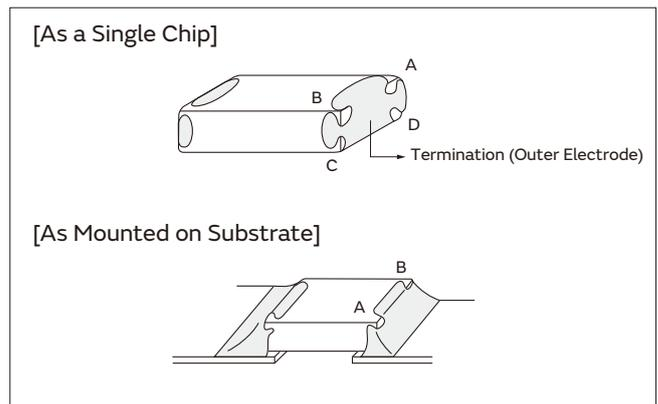

3. Reflow Soldering

The flux in the solder paste contains halogen-based substances and organic acids as activators. Strong acidic flux can corrode the capacitor and degrade its performance. Please check the quality of capacitor after mounting.

Continued on the following page. ↗

GRT Series
 GCM Series
 GC3 Series
 GCJ Series
 GCQ Series
 GCD Series
 GCE Series
 NFM Series
 KCM Series
 KC3 Series
 KCA Series
 GCB Series
 GCG Series
 Notice

Notice

Continued from the preceding page. ↘

4. Washing

1. Please evaluate the capacitor using actual cleaning equipment and conditions to confirm the quality, and select the solvent for cleaning.

5. Coating

1. A crack may be caused in the capacitor due to the stress of the thermal contraction of the resin during curing process.
The stress is affected by the amount of resin and curing contraction.
Select a resin with low curing contraction.
The difference in the thermal expansion coefficient between a coating resin or a molding resin and the capacitor may cause the destruction and deterioration of the capacitor such as a crack or peeling, and lead to the deterioration of insulation resistance or dielectric breakdown.
Select a resin for which the thermal expansion coefficient is as close to that of the capacitor as possible.
A silicone resin can be used as an under-coating to buffer against the stress.

2. Unsuitable cleaning may leave residual flux or other foreign substances, causing deterioration of electrical characteristics and the reliability of the capacitors.

2. Select a resin that is less hygroscopic.
Using hygroscopic resins under high humidity conditions may cause the deterioration of the insulation resistance of a capacitor.
An epoxy resin can be used as a less hygroscopic resin.
3. The halogen system substance and organic acid are included in coating material, and a chip corrodes by the kind of Coating material.
Do not use strong acid type.

Other

1. Transportation

1. The performance of a capacitor may be affected by the conditions during transportation.
 - 1-1. The capacitors shall be protected against excessive temperature, humidity, and mechanical force during transportation.
 - Mechanical condition
Transportation shall be done in such a way that the boxes are not deformed and forces are not directly passed on to the inner packaging.
 - 1-2. Do not apply excessive vibration, shock, or pressure to the capacitor.
 - (1) When excessive mechanical shock or pressure is applied to a capacitor, chipping or cracking may occur in the ceramic body of the capacitor.
 - (2) When the sharp edge of an air driver, a soldering iron, tweezers, a chassis, etc. impacts strongly on the surface of the capacitor, the capacitor may crack and short-circuit.
 - 1-3. Do not use a capacitor to which excessive shock was applied by dropping, etc.
A capacitor dropped accidentally during processing may be damaged.

2. Characteristics Evaluation in the Actual System

1. Evaluate the capacitor in the actual system, to confirm that there is no problem with the performance and specification values in a finished product before using.
2. Since a voltage dependency and temperature dependency exists in the capacitance of high dielectric type ceramic capacitors, the capacitance may change depending on the operating conditions in the actual system. Therefore, be sure to evaluate the various characteristics, such as the leakage current and noise absorptivity, which will affect the capacitance value of the capacitor.
3. In addition, voltages exceeding the predetermined surge may be applied to the capacitor by the inductance in the actual system. Evaluate the surge resistance in the actual system as required.

<Applicable to NFM Series>

4. The effects of noise suppression can vary depending on the usage conditions, including differences in the circuit or IC to be used, the type of noise, the shape of the pattern to be mounted, and the mounting location. Be sure to verify the effect on the actual device in advance.

GRT Series

GCM Series

GC3 Series

GCJ Series

GCQ Series

GCD Series

GCE Series

NFM Series

KCM Series

KC3 Series

KCA Series

GCB Series

GCG Series

Notice

Design Support Tool "SimSurfing"

<https://ds.murata.co.jp/simsurfing/index.html>

This is the latest tool to get the electrical characteristics for Capacitors, Inductors, and EMI Suppression Filters, and to simulate Thermistors' behavior !

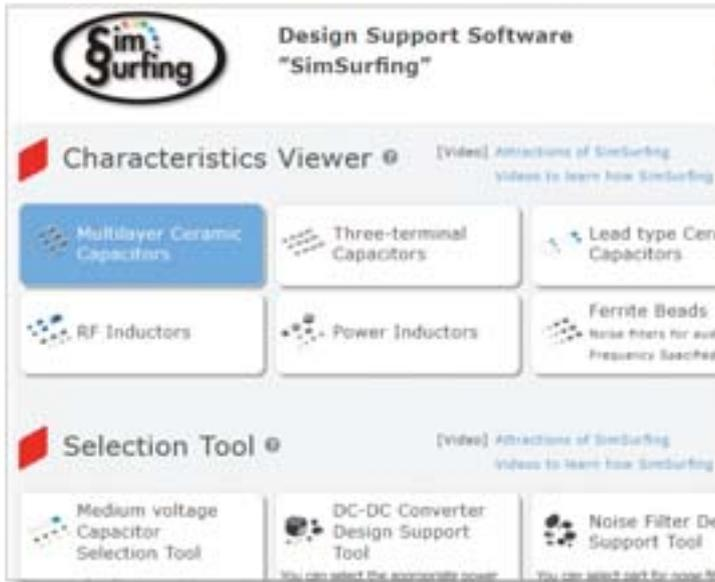

■ Characteristics viewer

You can easily search and download the following data for Multilayer Ceramic Capacitors, Polymer Capacitors, EMI Suppression Filters (Three-terminal Capacitors, Ferrite Beads) and Power/RF Inductors.

■ Components performance simulator

You can search by the simulation on simple circuits for Thermistors.

■ Selection tool

You can select Medium voltage Capacitors and Power Inductors according to conditions of use.

* Medium voltage: Rated Voltage 250V and over

■ Search tool

You can search the Murata timing device (CERALOCK® and crystal units) that is most suitable for your IC and access information about the recommended circuit constant setting.

■ Usage example of "Multilayer Ceramic Capacitors"

1 Select the products

- (1) By performance/type
- (2) By part number

2 Show graph

Click each button on each tab of [Basic], [S-parameter] and [Detailed].

3 Data download

- Click each purple button in this area.
- Click "CSV output" button.

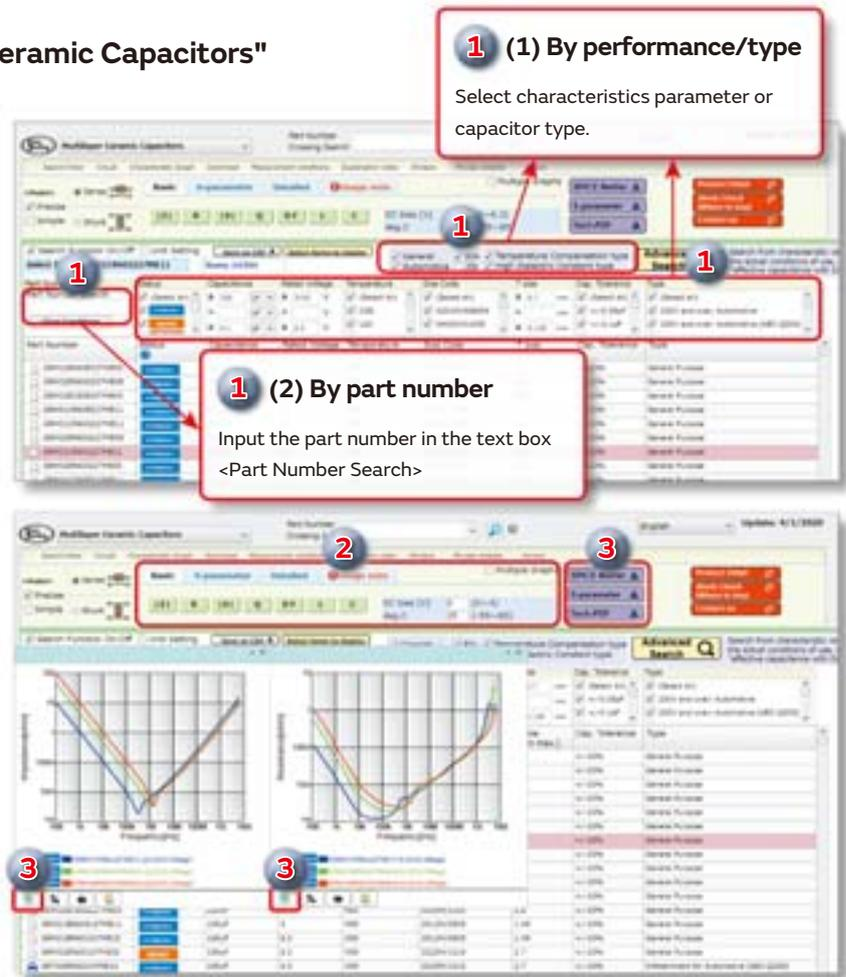

* Images are as of May 2020. Be assured that this software will be updated frequently.

<https://ds.murata.co.jp/simsurfing/index.html>

Web page Introduction



Search by Part Number

<https://www.murata.com/search/productsearch?cate=cgsubCeramicCapacitors>

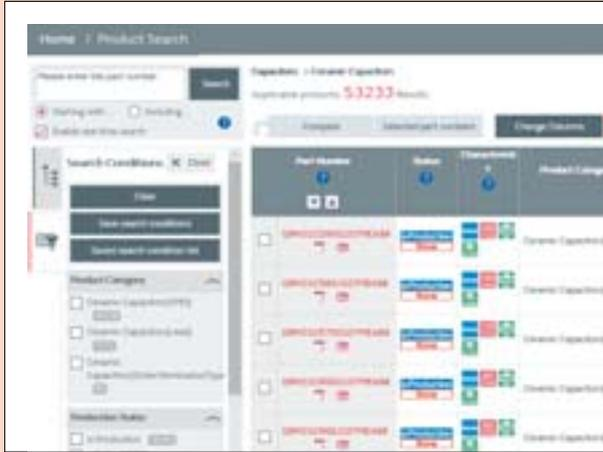

You can search for capacitors by specifying the alphanumeric characters in the part number. The packing codes shown contain the substitute character "#". If you enter the official packing code, part numbers that contain that packing code will be matched.



Search by Specifications

<https://www.murata.com/search/productsearch?cate=luCeramicCapacitorsSMD#spec>

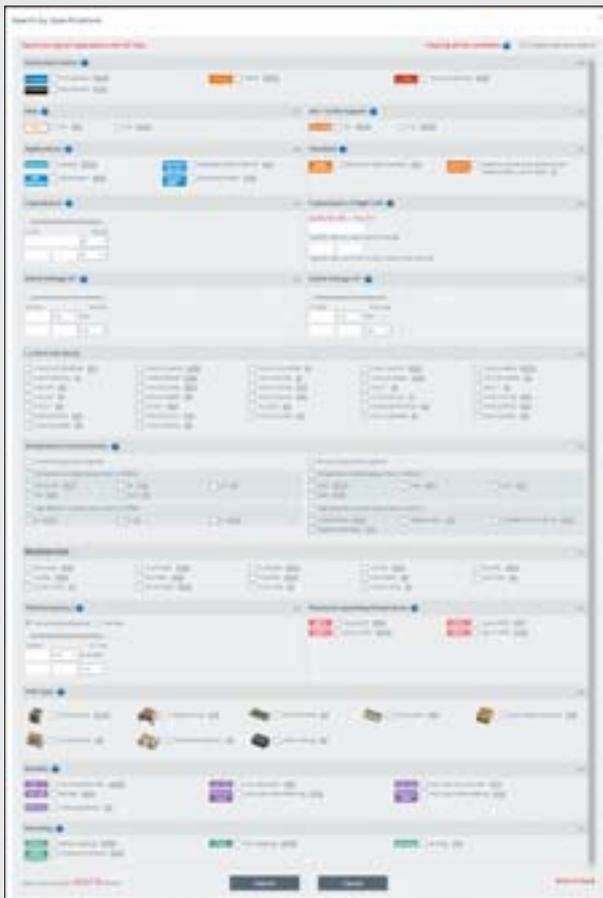

You can search for SMD, lead type, or screw termination type capacitors by indicating specifications such as application, capacitance, rated voltage, or temperature characteristics.

You can narrow your search by entering values of ranges, and by specifying product characteristics.

The items for narrowing searches are linked, so specifying one condition causes selectable options for the other items to allow input only of conditions that match the relevant part numbers.



Search in the Lineups

<https://www.murata.com/products/capacitor/mlcc/lineup>

You can search for capacitors by specifying the series lineup.

You can also confirm items such as characteristics and applications on each series page.



Capacitance chart in Series page.

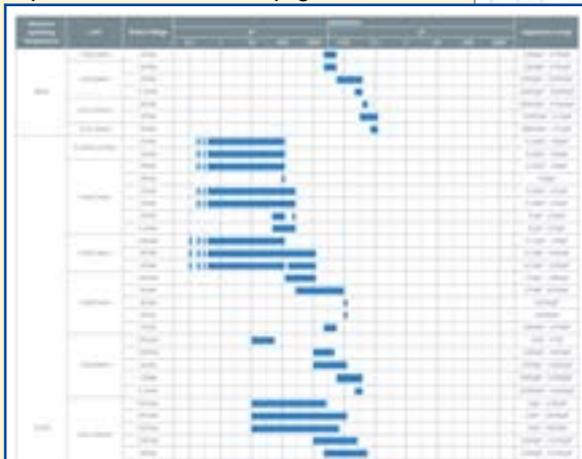

[Search result]

Compares the characteristics of the checked part numbers.

Displays the number of hits for the current search conditions in real time.

Click the ▲ mark for each item to switch between ascending and descending display.

Click a product name to display a details page listing more in-depth information (→ P44).

You can download detailed spec sheets.

For some products it is possible to request a free sample.

Icons enable you to check the status and characteristics of products at a glance.

You narrow the search results to match the selected condition in real time.

You can confirm the current conditions for narrowing the search results.

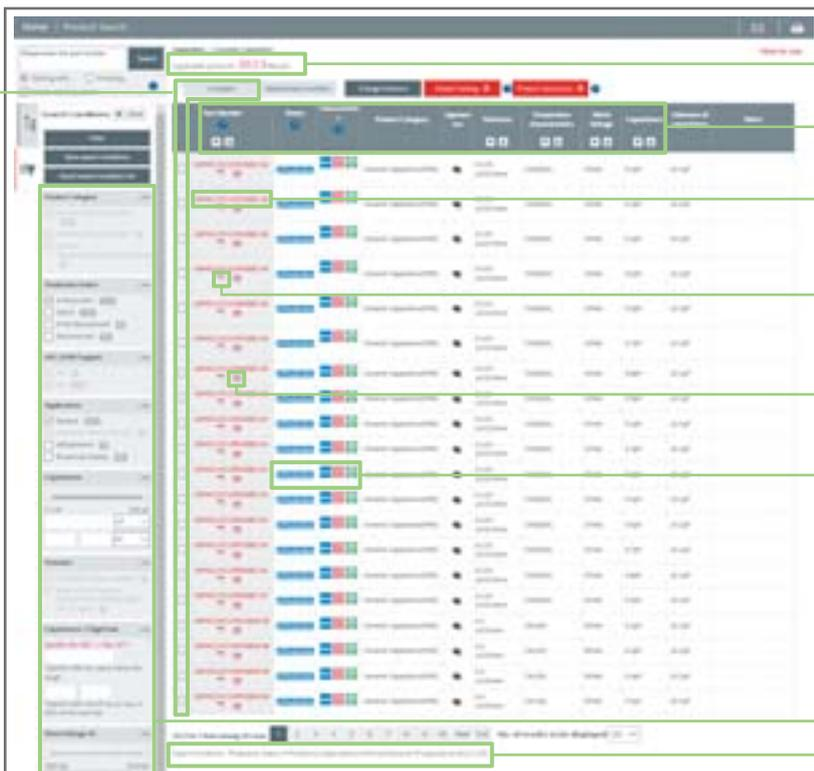

Global Locations

For details please visit www.murata.com



⚠ Note

1 Export Control

For customers outside Japan:

No Murata products should be used or sold, through any channels, for use in the design, development, production, utilization, maintenance or operation of, or otherwise contribution to (1) any weapons (Weapons of Mass Destruction [nuclear, chemical or biological weapons or missiles] or conventional weapons) or (2) goods or systems specially designed or intended for military end-use or utilization by military end-users.

For customers in Japan:

For products which are controlled items subject to the "Foreign Exchange and Foreign Trade Law" of Japan, the export license specified by the law is required for export.

2 Please contact our sales representatives or product engineers before using the products in this catalog for the applications listed below, which require especially high reliability for the prevention of defects which might directly damage a third party's life, body or property, or when one of our products is intended for use in applications other than those specified in this catalog.

- ① Aircraft equipment
- ② Aerospace equipment
- ③ Undersea equipment
- ④ Power plant equipment
- ⑤ Medical equipment
- ⑥ Transportation equipment (vehicles, trains, ships, etc.)
- ⑦ Traffic signal equipment
- ⑧ Disaster prevention / crime prevention equipment
- ⑨ Data-processing equipment
- ⑩ Application of similar complexity and/or reliability requirements to the applications listed above

3 Product specifications in this catalog are as of May 2020. They are subject to change or our products in it may be discontinued without advance notice. Please check with our sales representatives or product engineers before ordering. If there are any questions, please contact our sales representatives or product engineers.

4 Please read rating and ⚠CAUTION (for storage, operating, rating, soldering, mounting and handling) in this catalog to prevent smoking and/or burning, etc.

5 This catalog has only typical specifications. Therefore, please approve our product specifications or transact the approval sheet for product specifications before ordering.

6 Please note that unless otherwise specified, we shall assume no responsibility whatsoever for any conflict or dispute that may occur in connection with the effect of our and/or a third party's intellectual property rights and other related rights in consideration of your use of our products and/or information described or contained in our catalogs. In this connection, no representation shall be made to the effect that any third parties are authorized to use the rights mentioned above under licenses without our consent.

7 No ozone depleting substances (ODS) under the Montreal Protocol are used in our manufacturing process.

Murata Manufacturing Co., Ltd.

www.murata.com

muRata
INNOVATOR IN ELECTRONICS