

# INTERCONNECTS

## SERIES 800 & 801 • .100" GRID (.030" DIA. PINS), STRAIGHT & RIGHT ANGLE HEADERS AND SOCKETS • SINGLE ROW STRIPS

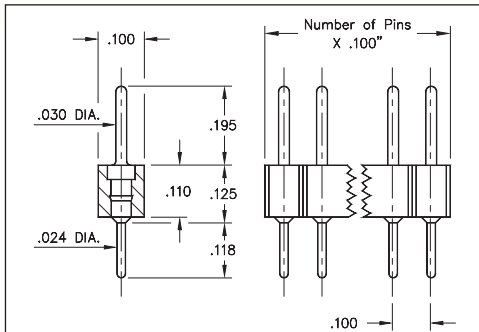

FIG. 1

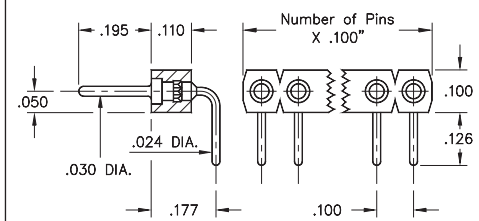

FIG. 2

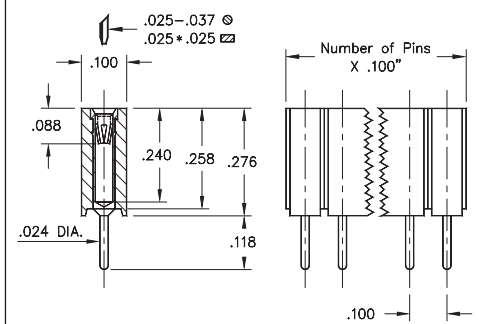

FIG. 3

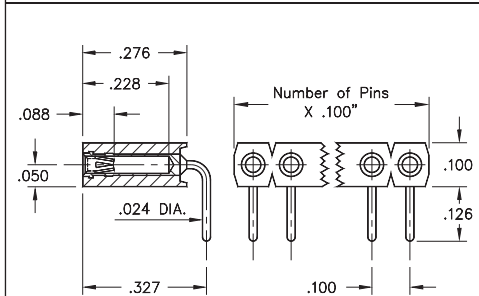
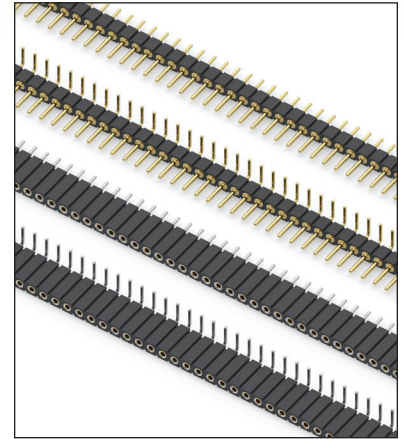

FIG. 4

- Pin interconnects available with straight MM #7007 or right angle MM #5005 solder tails. See page 215 for details
- Sockets are available with straight MM #1304 or right angle MM #1305 soldertails. See pages 177 and 179 for details
- MM #1304 and MM #1305 receptacles use Hi-Rel, 6-finger BeCu #47 contact rated at 4.5 amps. Receptacles accept .030" diameter and .025" square pins. See page 256 for details
- Insulators are high temperature thermoplastic, suitable for all soldering operations



### ORDERING INFORMATION

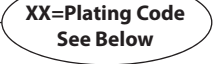



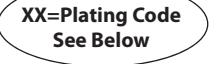
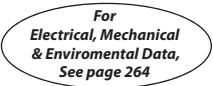

FIG. 1	Series 800...10-001		Straight Pin Header	
		800-XX-0	-10-001000	01-64
Specify number of pins				
FIG. 2	Series 800...20-001		Right Angle Pin Header	
		800-XX-0	-20-001000	02-64
Specify number of pins				
  				
SPECIFY PLATING CODE XX=				
Pin Plating 				
	10	90	40	
	10 μ" Au	200 μ" Sn/Pb	200 μ" Sn	

FIG. 3	Series 801...10-001		Straight Socket				
		801-XX-0	-10-001000	01-50			
Specify number of pins							
FIG. 4	Series 801...20-001		Right Angle Socket				
		801-XX-0	-20-001000	01-50			
Specify number of pins							
  							
SPECIFY PLATING CODE XX=							
Sleeve (Pin) 							
Contact (Clip) 							
	91	93	99	41	43	44	47
	200 μ" Sn/Pb	200 μ" Sn/Pb	200 μ" Sn/Pb	200 μ" Sn	200 μ" Sn	200 μ" Sn	200 μ" Sn
	10 μ" Au	30 μ" Au	100 μ" Sn/Pb	10 μ" Au	30 μ" Au	100 μ" Sn	Au Flash

★ 44 Plating Non-Standard



# Mouser Electronics

Authorized Distributor

Click to View Pricing, Inventory, Delivery & Lifecycle Information:

## Mill-Max:

[801-99-050-20-001000](#) [801-99-050-10-001000](#) [801-99-036-10-001000](#) [801-93-036-10-001000](#) [800-90-064-20-001000](#) [800-90-064-10-001000](#) [800-90-020-20-001000](#) [800-90-020-10-001000](#) [800-10-020-20-001000](#) [800-10-020-10-001000](#) [800-10-064-20-001000](#) [800-90-010-20-001000](#) [800-10-002-10-001000](#) [801-93-050-10-001000](#) [801-93-003-10-001000](#) [801-93-001-10-001000](#) [801-93-014-10-001000](#) [800-10-012-10-001000](#) [800-10-016-10-001000](#) [800-10-010-10-001000](#) [801-93-011-20-001000](#) [801-93-010-10-001000](#) [801-93-011-10-001000](#) [801-93-004-20-001000](#) [801-93-002-10-001000](#) [801-93-050-20-001000](#) [801-99-036-20-001000](#) [801-93-020-10-001000](#) [801-43-036-20-001000](#) [801-43-036-10-001000](#) [800-40-064-20-001000](#) [800-40-064-10-001000](#) [800-40-020-20-001000](#) [800-40-020-10-001000](#) [801-41-020-10-001000](#) [800-10-004-20-001000](#) [800-10-064-10-001000](#) [800-10-008-10-001000](#) [800-10-002-20-001000](#) [801-93-036-20-001000](#) [801-43-050-20-001000](#) [801-43-050-10-001000](#) [800-40-015-20-001000](#) [800-90-040-10-001000](#) [800-10-014-10-001000](#)