

2.5 MM SIGNAL DOUBLE LOCK CONNECTORS

Quick Reference Guide

The 2.5 mm signal double lock (2.5 SDL) connectors are compact, single row connectors available in both wire-to-wire and wire-to-board configurations. The signal double lock connector system consists of plug and cap housings for wire termination, optional double lock plates, crimp contacts and PC board pin headers in both standard and high profile versions. The signal double lock accepts 26-20 AWG wire with insulation diameters up to 1.8 mm and is rated up to 3 Amps per line. Signal double lock connectors are now available in material meeting the Glow Wire test according to IEC 60335-1 5th Edition: Household and Similar Appliances — Safety (750°C, no flame) and UL 94 V-0.

FEATURES & BENEFITS

- Discrete wire interconnect available in 2-13 position wire-to-board and 2-10 position wire-to-wire
- Audible click when contact is fully inserted into the housing
- Polarizing ribs on plug housing allows proper mating
- Solder tail kink along with the polarization peg (boss) feature, secures the header on the board during the solder process
- Board-mounted headers are compatible with resin or conformal coatings — no drain holes
- Multiple colors available for ease of connector identification during assembly and maintenance
- UL recognized, CSA certified and TUV approved
- Choice of V-0 rated material or GWT and V-0 rated material

PRODUCT APPLICATIONS

- Household appliances
- Gaming
- Vending
- Garage door openers
- Security systems
- Industrial controls
- HVAC system controls
- Fan modules
- Business equipment

2.5 mm Signal Double Lock Connectors

Quick Reference Guide

CONTACTS

Wire Range		Wire Insulation Dia. mm	Tab	Receptacle	Applicator Part Numbers			
AWG	mm ²		Strip Form	Strip Form	Automatic	Semiautomatic		Extraction Tool
						K press	K press	
26-22	0.12-0.35	0.93-1.50	917765-1	917684-1	680403-1	680403-2	680403-3	234605-1
22-20	0.30-0.53	1.4-1.80	917764-1	917683-1	680404-1	680404-2	680404-3	

For more information, see Application Specification 114-5203 & Instruction Sheet 411-5737

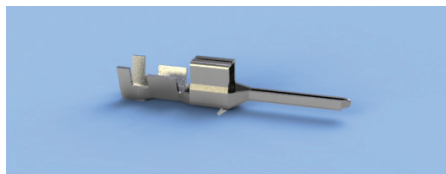

Tab

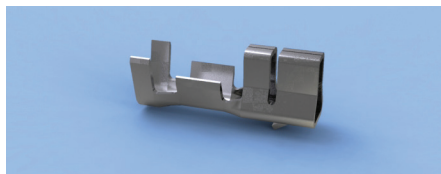

Receptacle

The signal double lock contacts are phosphor bronze with pre-tin plating. The receptacle contact gets loaded into the plug housings and the tab contact gets loaded into the cap housings.

CAP HOUSINGS

No. of Pos.		V-O Material Base Part No. & Available Colors (Part No. Suffix) ^{1,5}					GWT & V-O Material Part No.	Double Lock Plate Part No.
		Natural	Red	Yellow	Blue	Black		
		Natural	Red	Yellow	Blue	Black	Natural	Natural
2	316086	-1	-2	-4	-6	-9	5-316086-1	917698-1
3	316087	-1		-4		-9	5-316087-1	917699-1
4	316088	-1	-2	-4		-9	5-316088-1	917700-1
5	316089	-1	-2				5-316089-1	917701-1
6	316090	-1					5-316090-1	917702-1
7	316091	-1				-9		917703-1
8	316092	-1					5-316092-1	917704-1
10	316094	-1		-4			5-316094-1	917706-1

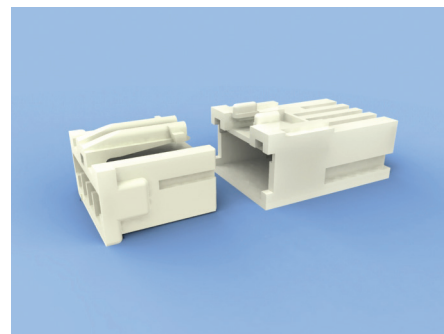

The signal double lock's latch on the plug housing and innerlocking cavity on the cap housings helps prevent unintentional disengagement and offers a snag-free connection.

PLUG HOUSINGS

No. of Pos.		V-O Material Base Part No. & Available Colors (Part No. Suffix) ^{1,5}						GWT & V-O Material Part No.	Double Lock Plate Part No.
		Natural	Red	Yellow	Green	Blue	Black		
		Natural	Red	Yellow	Green	Blue	Black	Natural	Natural
2	917686	-1	-2	-4	-5	-6	-9	5-917686-1	917698-1
3	917687	-1	-2	-4		-6	-9	5-917687-1	917699-1
4	917688	-1	-2	-4			-9	5-917688-1	917700-1
5	917689	-1	-2			-6		5-917689-1	917701-1
6	917690	-1	-2	-4		-6	-9	5-917690-1	917702-1
7	917691	-1	-2	-4			-9	5-917691-1	917703-1
8	917692	-1				-6		5-917692-1	917704-1
9	917693	-1	-2	-4				5-917693-1	917705-1
10	917694	-1		-4				5-917694-1	917706-1
11	917695	-1						5-917695-1	917707-1
12	917696	-1	-2					5-917696-1	917708-1
13	917697	-1	-2					5-917697-1	917709-1

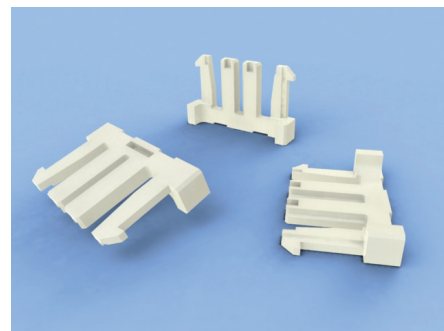

A double lock plate is available for both plug and cap housings to ensure positive loading and to help prevent contact back-out.

Notes:

- When ordering all housings and headers, use base part number and desired color code as the suffix. Housings meeting Glow Wire Test and V-O are only available in Natural.
- When ordering loose piece headers, use the prefix 2- to indicate the option of no polarization peg (boss).
- When ordering radial tape-mounted headers, use the prefix 3- to indicate the option with a polarization leg (boss).
Example: 2-917785-2 is a 7 position, red loose piece header with no polarization peg (boss).
- Available in a natural color only.
- Color Key Code: -1 Natural, -2 Red, -4 Yellow, -5 Green, -6 Blue, -9 Black

2.5 mm Signal Double Lock Connectors

Quick Reference Guide

VERTICAL POST HEADERS: STANDARD PROFILE—GLOW WIRE TEST AND V-0 MATERIAL

No. of Pos	Loose Piece Base Part No. & Available Colors (Part No. Suffix) ^{1,2,5}						Radial Tape Base Part No. & Available Colors (Part No. Suffix) ^{1,3,5}						Pack Qty.
		Natural	Red	Yellow	Blue	Black		Natural	Red	Yellow	Blue	Black	
2	917780	-1	-2			-9	917894	-1			-6	-9	900
3	917781	-1	-2			-9	917895	-1	-2		-6		900
4	917782	-1	-2	-4		-9	917896	-1					450
5	917783	-1	-2		-6		917897	-1	-2				450
6	917784	-1	-2			-9	917898	-1					450
7	917785	-1	-2	-4			917899	-1	-2	-4			450
8	917786	-1			-6		917800	-1					450
9	917787	-1	-2										
10	917788	-1											
11	917789	-1											
12	917790	-1	-2										
13	917791	-1	-2										

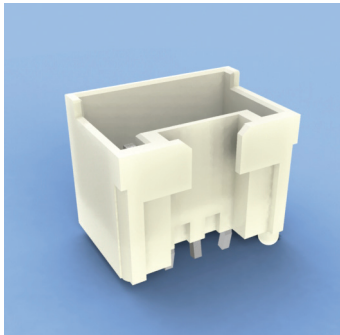

The solder tail of the loose-piece pin header features kinks to secure the connector on the PC board until the soldering process is complete.

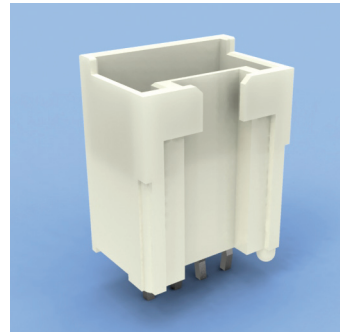

The high profile type header is designed specifically for resin coated boards typically used for waterproof protection in the manufacture of home appliance PCBs. This header is designed to mate with the standard signal double lock plug housings.

Signal double lock headers are available packaged on radial tape for use with radial mounting machines.

VERTICAL POST HEADERS: HIGH PROFILE – GLOW WIRE TEST AND V-0 MATERIAL

No. of Pos	Loose Piece Base Part No. & Available Colors (Part No. Suffix) ^{1,2,5}							Radial Tape Part Number ^{3,4}	Pack Qty.
		Natural	Red	Yellow	Green	Blue	Black		
2	917722	-1	-2	-4	-5	-6	-9	316221-1	900
3	917723	-1						316222-1	900
4	917724	-1						316223-1	450
5	917725	-1		-4		-6		316224-1	450
6	917726	-1						316225-1	450
7	917727	-1						316226-1	450
8	917728	-1						316227-1	450
9	917729	-1							
10	917730	-1							
11	917731	-1							
12	917732	-1							
13	917733	-1							

CONNECTOR KITS PROVIDED BY WALDOM ELECTRONICS

Kit Part Number	Description
2110850-1	Signal Double Lock Connector Kit

Note: Design kits are designed and assembled by Waldom Electronics and are available for purchase through your local distributor.

2.5 mm Signal Double Lock Connectors

Quick Reference Guide

Questions that will help you better select the product that you need:

What are the current and voltage requirements for your application?

The signal double lock connector system has a maximum current rating of 3 Amps per line and is rated for 50 Volts AC/DC and 250 VAC.

What are the wire type and size requirements?

The signal double lock connector system is approved for use with 26-20 AWG wire with a wire insulation range between 0.93 mm and 1.8 mm.

What are the number of positions and available space?

The signal double lock connector system is available in 2-13 position wire-to-board and 2-10 position wire-to-wire configurations on a 2.5 mm pitch. The overall mated length of the free-hanging system is 22.6 mm and the maximum height with the standard profile header is 13.7 mm while the maximum height with the high-profile header is 19.2 mm.

What are the flammability requirements for your application?

Signal double lock connectors are offered with various housings rated UL 94 V-0, and meeting the Glow Wire Test according to IEC 60335-1 5th edition.

What are the operating temperature requirements?

The signal double lock connector system has a maximum operating temperature of 105°C. For more information regarding operating temperatures refer to Product Specification 108-5459.

Is contact back-out a concern? Do you need confirmation that the contacts are seated?

The signal double lock connector system offers an optional double lock plate. The purpose of the double lock plate is to allow the contacts to be fully seated in the housing.

Do you need to differentiate this connector from other connectors in the application?

The signal double lock connector system offers multiple options of colored housings for ease of connector identification during manufacturing and assembly.

What is the benefit of choosing high-profile over standard-profile headers?

The signal double lock connector system offers high profile headers for applications where there will be additional processing or resin coating of the PCB's during the manufacturing process.

What is the benefit of choosing headers with a polarization peg (boss)?

The signal double lock connector system offers headers with or without polarization pegs. The purpose of this feature is to polarize the headers to the PCB so the header can not be placed on the PCB in the wrong orientation. For more information regarding PCB layout please refer to the header product drawing.

TE TECHNICAL SUPPORT CENTER

USA:	+1 (800) 522-6752
Canada:	+1 (905) 475-6222
Mexico:	+52 (0) 55-1106-0800
Latin/S. America:	+54 (0) 11-4733-2200
Germany:	+49 (0) 6251-133-1999
UK:	+44 (0) 800-267666
France:	+33 (0) 1-3420-8686
Netherlands:	+31 (0) 73-6246-999
China:	+86 (0) 400-820-6015

Part numbers in this brochure are RoHS Compliant*, unless marked otherwise.

*as defined www.te.com/leadfree

te.com

TE Connectivity, TE Connectivity (logo) and Every Connection Counts are trademarks. All other logos, products and/or company names referred to herein might be trademarks of their respective owners.

The information given herein, including drawings, illustrations and schematics which are intended for illustration purposes only, is believed to be reliable. However, TE Connectivity makes no warranties as to its accuracy or completeness and disclaims any liability in connection with its use. TE Connectivity's obligations shall only be as set forth in TE Connectivity's Standard Terms and Conditions of Sale for this product and in no case will TE Connectivity be liable for any incidental, indirect or consequential damages arising out of the sale, resale, use or misuse of the product. Users of TE Connectivity products should make their own evaluation to determine the suitability of each such product for the specific application.

© 2017 TE Connectivity Ltd. family of companies All Rights Reserved.

1773458-3 11/17 Revised

Mouser Electronics

Authorized Distributor

Click to View Pricing, Inventory, Delivery & Lifecycle Information:

[TE Connectivity:](#)

[316087-1](#)