

AVX

A KYOCERA GROUP COMPANY

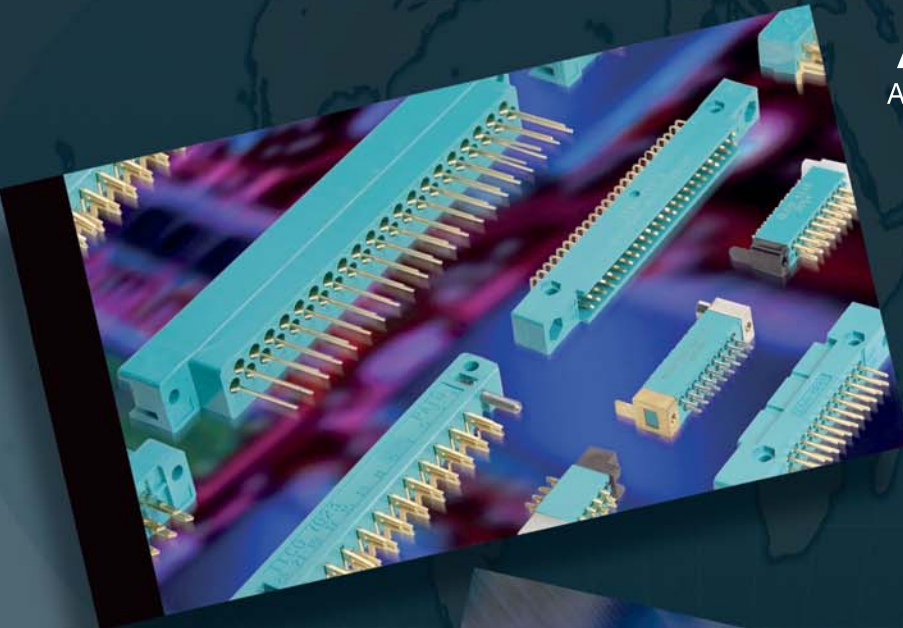

AVX Varicon

<Version 13.10>

The Varicon Range.....	2
Introduction to Varicon.....	3

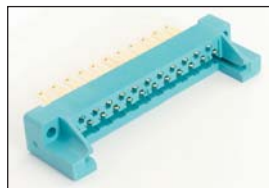

Series 7008
Page 6



Tools
Page 26

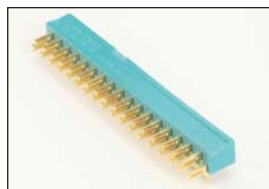

Series 7022
Page 8

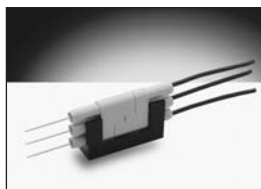

Series 8020
Page 27

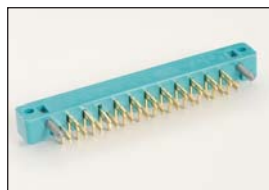

Series 7023
Page 9

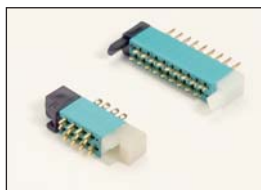

Series 8218
Page 28

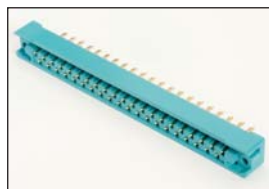

Series 7024
Page 10



Series 8219
Page 30

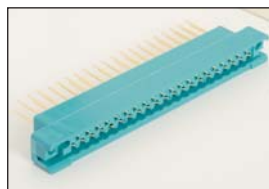

Series 7038
Page 12

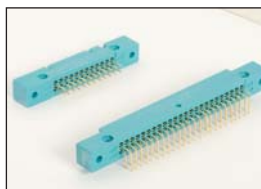

Series 8223
Page 32



Series 8016
Page 14

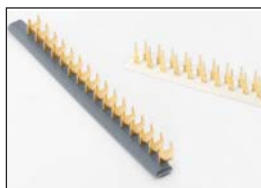

Contact Strips
Page 34



Series 8017
Page 24

The Varicon Range



Pitch	Number of Contacts	Body Style	Termination Types	Current Rating (Amps)	Series Number
0.050"	2 to 152	Plugs and Receptacles	Staggered, Fixed: Solder, Eyelet	5	8218
0.050"	18, 30, 36, 42, 54, 72	Plugs and Receptacles	Staggered, Fixed: Straight & Right Angle Solder, Eyelet	5	8219
0.075" x 0.130" & 0.075" x 0.150"	20, 38, 56, 90, 120 75, 100, 130	Plugs and Receptacles	Staggered, Removable: Taper Tab, Eyelet, Wire Wrap, Crimp	8	8016 8017
0.100"	17, 23, 29, 35, 41	Receptacles	Same as series 7024	8	7008
0.100"	17, 23, 29, 35, 41, 47	Plugs	Staggered, Fixed: Solder	6	7022
0.100"	17, 23, 29, 35, 41, 47	Receptacles	Staggered, Fixed: Solder	6	7023
0.100"	17, 23, 29, 35, 41	Receptacles	Staggered, Fixed: Solder, Taper Tab, Eyelet, Wire Wrap, Bus Line	8	7024
0.100"	17, 23, 29, 35, 41, 47	Receptacles	Staggered, Removable: Taper Tab, Eyelet, Wire Wrap, Crimp	8	7038
0.100"	24, 48, 72, 96	Plugs and Receptacles	Square Grid Dual Row, Fixed: Straight and Right Angle Solder, Eyelet, Wire Wrap, Crimp Wrappable Removable	5	8223
0.200"	2, 3	Plugs and Receptacles	In-line Fixed: Solder Crimp	8.5	8020

Introduction

AVX's Varicon product range is available as two-piece input / output and board level connectors (intermateable plugs and receptacles). Varicon contacts are also available in strips, on disposable carriers, ready for staking to p.c. cards. They all use the famous, fork-like Varicon® (fixed) or Varilok® (insertable / removable) hermaphroditic contact design.

VARICON DESIGN ADVANTAGES

AVX's hermaphroditic Varicon contact utilizes a fork-like design incorporating four large mating surfaces that are coined to achieve exceptional hardness and smoothness. The mating surfaces are wedged together by the spring-like design of the contact and by the innate properties of the contact material. The Varicon contact has proven its reliability in innumerable applications and with over one-million contacts being produced daily, billions of successful, trouble-free operating hours have been logged.

FEATURES

- Four intimate contact areas, electrically parallel
- High current carrying capability, excellent heat dissipation
- Self-cleaning, wiping action burnishes contacting surfaces reducing constrictive resistance
- Low contact resistance 3 to 4 milliohms
- Stable in vibration and adverse environments
- High contact normal pressure achieved at low stress levels

HIGH RELIABILITY

The mating surfaces provide a gas-tight connection and resists corrosion caused by adverse environments. This seal is made possible by the spring-like properties of the Varicon contact and by the smoothness of the coined mating surfaces. After being mated for years, the contacts still retain clean, unoxidized mating surfaces.

LOW RESISTANCE

Because of the spring-like properties of the Varicon contact, both sides of the contact are always under considerable pressure when mated. Their sliding and wiping action burnishes the surfaces in a self-cleaning action reducing any constrictive resistance. The low contact resistance remains a permanent feature of the Varicon contact even after thousands of mating and unmating cycles.

HIGH CURRENT CAPACITY

The low contact resistance contributes substantially to Varicon's high current-carrying capacity. Also, its heat-dissipating characteristics are enhanced by its flat configuration.



SHOCK AND VIBRATION RESISTANCE

Should external forces cause any decrease in contact pressure between two of the four mating surfaces, it is automatically compensated by redistributing the contact pressure between the other two mating surfaces.

ECONOMY

Varicon contacts are stamped from sheet stock instead of screw-machined. Consequently, this production method not only increases the production capacity but decreases production cost as there is little waste.

VERSATILITY

The Varicon concept can be used in a card-mounted plug that mates with a receptacle, or Varicon contacts can be staked directly to a pc board and soldered into place. This latter method eliminates the need for a conventional plug reducing the cost of the connection system while retaining the proven reliability of the Varicon interconnection.

CONTACT TYPES

Two basic sizes of our Varicon contact are available: standard and miniature Varicon. And each size has two major variations: the fixed Varicon contact and the Varilok insertable / removable version. The standard size is rated at 8 amps and has a withdrawal force range of 2 to 16 ounces per contact. The miniature size is specifically for high density applications and is rated at 5 amps with a withdrawal force of 2 to 8 ounces per contact. (For exact specifications, check the individual series listing.)



Miniature Varicon®



Standard Varicon®

Introduction

CONTACT MATERIAL

The primary contact material used is phosphor bronze. The electrical conductivity of copper alloys are extremely good. Within the Varicon concept, the contacts must also perform as springs and these alloys offer the elastic properties and the endurance required by today's rugged applications.

CONTACT PLATING

A nickel underplate of 50 to 100 microinches, followed by a minimum of 10 microinches of gold plate is AVX's standard contact plating. The gold plate prevents the formation of insulating oxide films while the nickel plate provides a hard backing. It, in turn, reduces wear on the gold and prevents diffusion between the gold and base metal. Other plating thicknesses, such as those required by military specifications, can be supplied on request.

VARILOK CRIMP-AND-INSERT CONTACTS

The crimp-termination, insertable / removable Varilok contact offers a solderless connection between wire and contact as well as strain relief for the wire. This contact snaps into the insulator quickly and easily. With our simple tool it can be removed without difficulty, yet it locks securely into place and cannot twist or bend out of alignment.



Loose Varilok Contacts



Reel-Mounted Varilok Contacts

Varilok contacts also are available with wire-wrappable, solder and taper-tab tail configurations. Available loose for small scale production and replacement purposes, the Varilok contact is also supplied on reels for use with fast, economical automatic crimping machines reducing man-hour requirements and production costs in medium and large-scale production runs. Because the contact can be crimped to the wire and installed into the insulator at any point during the manufacturing operation, it offers the user convenience and flexibility. Reels contain 1800 standard contacts or 3000 miniature contacts.

All commercial Varicon products are RoHS compliant.

Introduction

MINI-VARILOK

The Mini-Varilok is half the size of the standard Varilok contact. It's designed for hand or machine crimping to solid or stranded AWG #22 to #30 wire. Its basic features are identical to the standard Varilok however it also incorporates a decreased insertion force and is used for high density applications. Production methods for the Mini-Varilok are the same as the standard Varilok.

CONTACT RETENTION

The Varilok contact, after undergoing five insertion / extraction cycles and being subjected to the vibration and shock tests of MIL-C-28731, still withstands an axial load in excess of 10 pounds (6 for mini-varilok).

WIRE SIZE

The Varilok contact with its open crimp barrel conforms to practically all specifications written for screw-machined contacts with closed crimp barrels. The crimp barrel of the Varilok contact is designed to accommodate wire sizes AWG #18 to #26. It's also possible to crimp together two stranded #22 or smaller wires. The Mini-Varilok accommodates wire sizes AWG #22 to #30. Table I lists the various sizes of wire to which Varilok contacts can be crimped, and indicates the minimum conductor diameter and the maximum insulator diameter that can be accommodated by the contacts. The crimp barrel is also crimped to the wire's insulation for strain relief and the large, overlapping ears of the barrel accommodate a wide range of wire insulation sizes (Table I). For an optimum crimp connection, the insulation is stripped one-eighth inch from the end of the conductor.

**Table I
Wire Sizes
(AWG)**

(Ref: MIL-W-16878/4 – Type E wire)

Single Wire	Varilok	Mini-Varilok	Conductor Diameter (Nominal)	Insulator Diameter (Max. Overall)
#18	Yes	No	.048	.074
#20	Yes	No	.038	.062
#22	Yes	Yes	.030	.054
#24	Yes	Yes	.024	.048
#26	Yes	Yes	.019	.043
#28	No	Yes	.015	.039
#30 (Stranded)	No	Yes	.012	.036

CRIMP CHARACTERISTICS

The illustration shows an enlarged cross-section of a typical Varilok crimp on a #22 stranded wire. No significant voids are visible. The complete deformation of the wire strands indicates optimum contact between the contact barrel and the conductors.

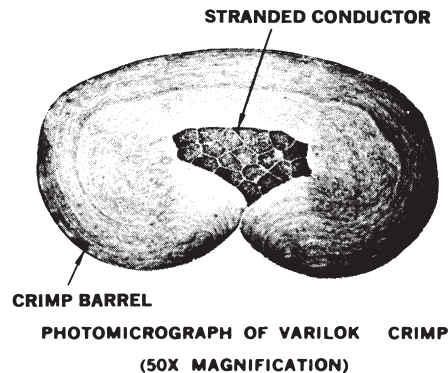

TENSILE STRENGTH

Table II lists the values, in pounds, of tensile strength (wire pull-out force) for Varilok and Mini-Varilok contacts crimped to stranded AWG #18 to #30 wires.

**Table II
Tensile Strength
(In Pounds)**

Wire Size (AWG)	#18	#20	#22	#24	#26	#28	#30
Stranded Wire	40	25	15	10	5	3	1.5

CRIMPING EQUIPMENT

All equipment needed to crimp Varilok and Mini-Varilok contacts is normally available from stock. Crimping equipment for production crimping as well as hand-operated crimping pliers are designed to realize the full electrical, mechanical and economical advantages of the Varilok and Mini-Varilok contact.

Series 7008 – 0.100" Staggered Dual Row

FEATURES

- Available with or without card guides
- Sizes 17, 23, 29, 35, 41
- Wide range of contact terminations
- For 1/16" thick PCB
- Polarization insert
- Mates with Series 7000 and 7022 Plugs

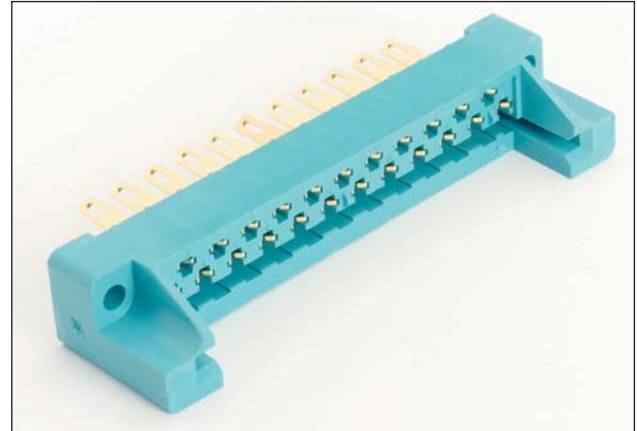

TECHNICAL SPECIFICATIONS

Current Rating:
10 amperes

Contact Resistance:
6 milliohms, maximum

Contact Material and Plating:
Phosphor Bronze per QQ-B-750, Composition A.

Gold, 10 microinches minimum, over nickel, 30 to 100 microinches

Insulator Material:
Diallyl phthalate, glass-filled, flame resistant, per MIL-M-14F, Type SDGF.

Insulation Resistance:
25,000 megohms, minimum

Dielectric Withstanding Voltage:
Sea Level: 2000 Volts rms
3.4" Hg: 675 Volts rms

Insertion/Withdrawal Force:
2 to 16 ounces per contact

Operating Temperature:
-40°C to +125°C

ORDERING CODE

00

7008

017

Number of Contacts
017, 023, 029, 035, 041

146

Contact Code
See table.

001

Variation Code
See table.

141 = 60 7001 06 33	
P.C. Termination for 1/8" Card	
156 = 60 7001 18 13	
Wire wrapping (.026 x .062 x .600")	
163 = 60 7001 19 13	
.098" Base Taper Tab w/Wire Hole	
166 = 60 7001 20 23	
Dual Solder Termination for 2 Wires or Bus Line (.056 x .125" Slot)	

Card Slot	Card Guides	Code
1/16"	Yes	001
	No	002

Connector Description	Availability				
	17	23	29	35	41
With Guides – for 1/16" Card	X	X	X	X	X
Without Guides – for 1/16" Card	X	X	X	X	X

Series 7008 – 0.100" Staggered Dual Row

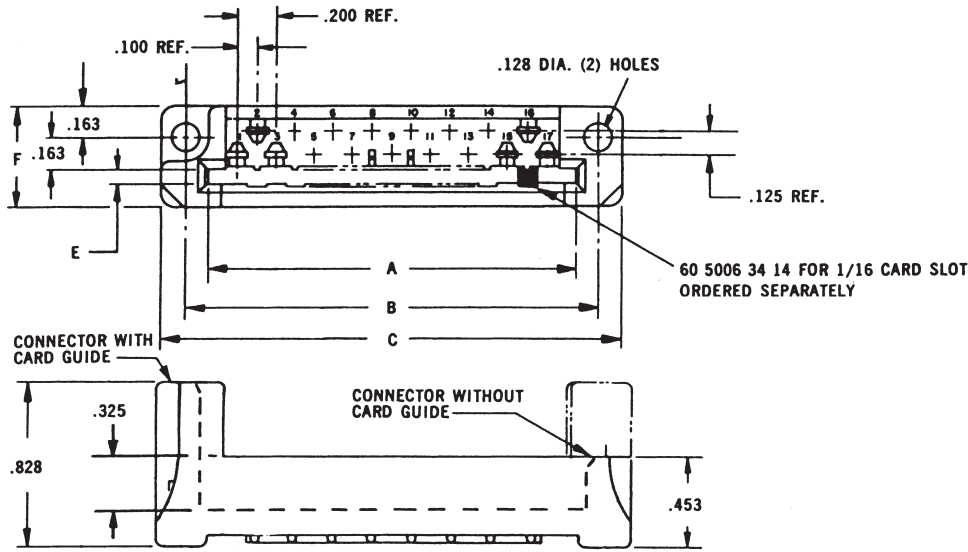

DIMENSIONS:

millimeters (inches)

Number of Contacts	A Bottom	B	C	D	E 1/16" Card	F	G*		H ±.003	L +.010 -.000	N*	
							Con.	N-Con.			Con.	N-Con.
17	1.920 (0.076)	2.134 (0.084)	2.40 (0.094)	1.835 (0.072)	.074 (0.003)	.531 (0.021)	.468 (0.018)	.343 (0.014)	1.600 (0.063)	1.900 (0.075)	.210 (0.008)	.148 (0.006)
23	2.520 (0.099)	2.734 (0.108)	3.00 (0.118)	2.435 (0.096)	.074 (0.003)	.531 (0.021)	.468 (0.018)	.343 (0.014)	2.200 (0.087)	2.500 (0.098)	.210 (0.008)	.148 (0.006)
29	3.120 (0.123)	3.334 (0.131)	3.60 (0.142)	3.035 (0.119)	.074 (0.003)	.531 (0.021)	.468 (0.018)	.343 (0.014)	2.800 (0.110)	3.100 (0.122)	.210 (0.008)	.148 (0.006)
35	3.270 (0.129)	3.934 (0.134)	4.20 (0.165)	3.635 (0.143)	.074 (0.003)	.531 (0.021)	.468 (0.018)	.343 (0.014)	3.400 (0.134)	3.700 (0.146)	.210 (0.008)	.148 (0.006)
41	4.320 (0.170)	4.534 (0.179)	4.80 (0.190)	4.235 (0.167)	.074 (0.003)	.531 (0.021)	.468 (0.018)	.343 (0.014)	4.000 (0.157)	4.300 (0.169)	.210 (0.008)	.148 (0.006)

*N-CON = Non-Conductive Chassis
(1/16" Clearance Around Contacts)

CON = Conductive Chassis
(1/8" Clearance Around Contacts)

P.C. CARD LAYOUT

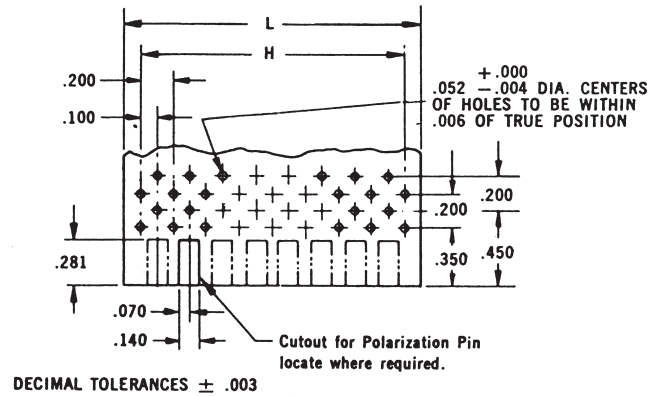
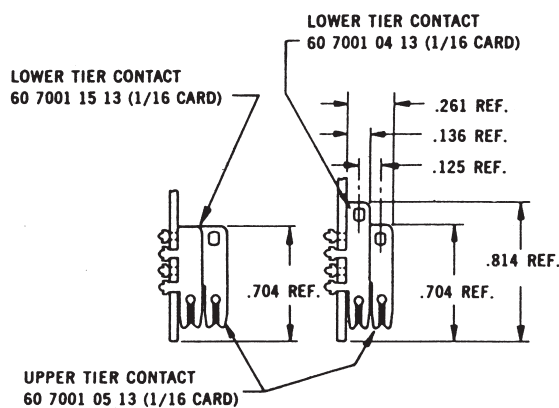

CHASSIS MOUNTING

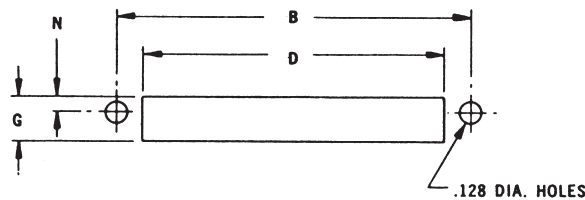

Series 7022 – 0.100" Staggered Dual Row

FEATURES

- Insulator rigidity reduces p.c. card warp
- Insulator maintains exact spacing between contacts
- Reduces cost of card punching operation (fewer holes)
- Reduces cost of contact staking operation (one operation instead of two)
- Reduces assembly time (no plastic strip to remove)
- For 1/16" or 3/32" p.c. card
- Mates with Series 7000 Receptacles with or without card guides

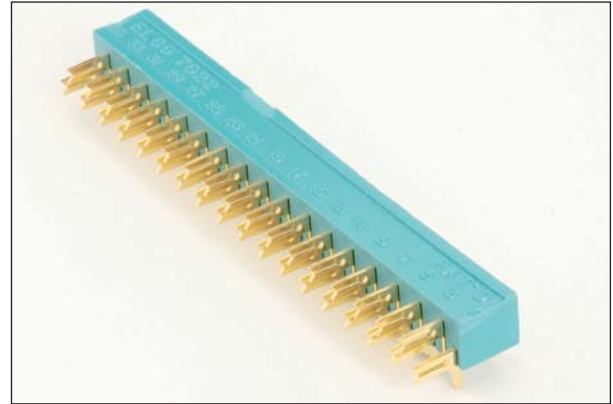

TECHNICAL SPECIFICATIONS

Current Rating:
10 amperes

Contact Resistance:
6 milliohms, maximum

Contact Material and Plating:
Phosphor Bronze per QQ-B-750, Composition A.

Gold, 10 microinches minimum, over nickel, 30 to 100 microinches

Insulator Material:
Diallyl phthalate, glass-filled, per MIL-M-14F, Type SDGF.
Variation 001/002
Thermoplastic Polycarbonate
Variation 003

Insulation Resistance:
25,000 megohms, minimum

Dielectric Withstanding Voltage:
Sea Level: 2000 Volts rms
3.4" Hg: 675 Volts rms

Insertion/Withdrawal Force:
2 to 16 ounces per contact

Operating Temperature:
-40°C to +125°C

ORDERING CODE

00

7022

023

Number of Contacts
017, 023, 029, 035, 041
For Series 7008 receptacle

000

001

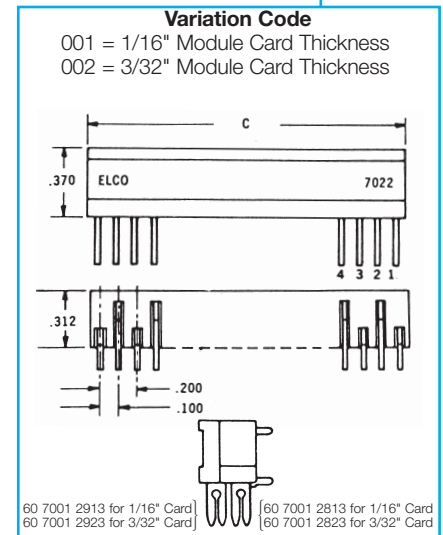

MOUNTING LAYOUT

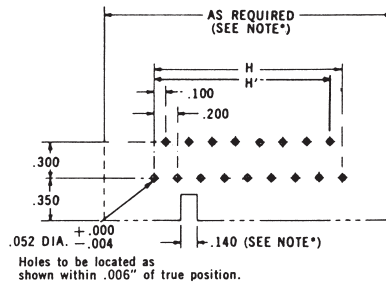

Series 7023 – 0.100" Staggered Dual Row

FEATURES

- Guide pins facilitate mating, ensure correct alignment
- Insulator rigidity reduces p.c. card warp
- Insulator maintains exact spacing between contacts
- Reduces cost of card punching operation (fewer holes)
- Reduces cost of contact staking operation (one operation instead of two)
- Reduces assembly time (no plastic strip to remove)
- For 1/16" or 3/32" p.c. card
- Mates with Series 7024 and 7038 Receptacles

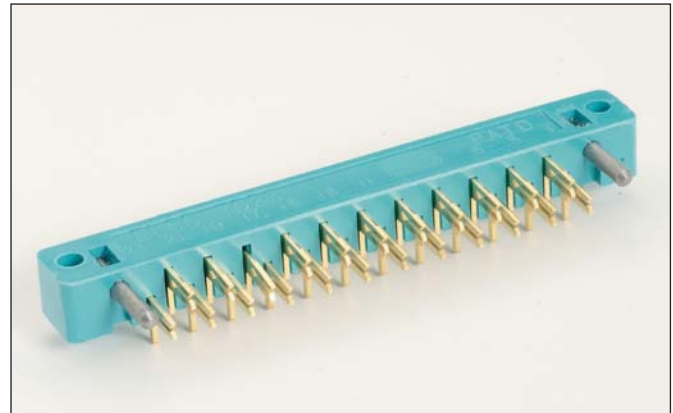

TECHNICAL SPECIFICATIONS

Current Rating:
10 amperes

Contact Resistance:
6 milliohms, maximum

Contact Material and Plating:
Phosphor Bronze per QQ-B-750,
Composition A.

Gold, 10 microinches minimum,
over nickel, 30 to 100 microinches

Insulator Material:
Diallyl phthalate, glass-filled, flame resistant
per MIL-M-14F, Type SDGF.

Variation 001/002/110/111
Thermoplastic Polycarbonate
Variation 003

Insulation Resistance:
25,000 megohms, minimum

Dielectric Withstanding Voltage:
Sea Level: 1800 Volts rms
3.4" Hg: 675 Volts rms

Insertion/Withdrawal Force:
2 to 16 ounces per contact

Operating Temperature:
-40°C to +125°C

ORDERING CODE

00

7023

023

000

001

Number of Contacts
017, 023, 029, 035, 041, 047

MOUNTING LAYOUT

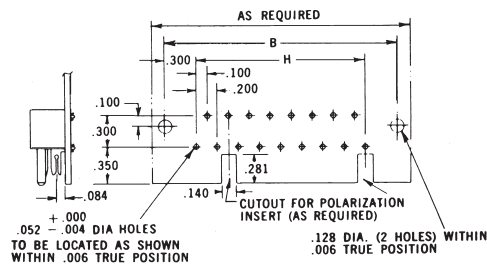

Contacts used in this connector:		
Card	Upper Card Contacts	Lower Card Contacts
1/16"	60 7001 29 13	60 7001 28 13
3/32"	60 7001 29 23	60 7001 28 23

Diallyl Phthalate Glass Filled	
1/16" Card	3/32" Card
001	002
110	111

DIMENSIONS: millimeters (inches)

Number of Contacts	B	C Max.	H
17	2.200 (0.087)	2.470 (0.097)	1.600 (0.063)
23	2.800 (0.110)	3.070 (0.121)	2.200 (0.087)
29	3.400 (0.134)	3.670 (0.144)	2.800 (0.110)
35	4.000 (0.157)	4.270 (0.168)	3.400 (0.134)
41	4.600 (0.181)	4.870 (0.192)	4.000 (0.157)
47	5.200 (0.205)	5.470 (0.215)	4.600 (0.181)

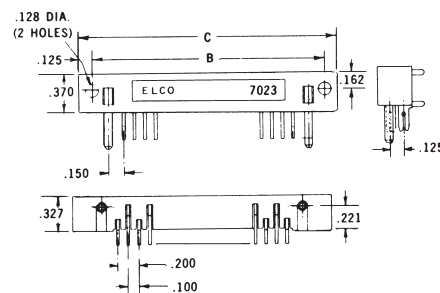

Series 7024 – 0.100" Staggered Dual Row

FEATURES

- Guide sockets facilitate mating, ensure correct alignment
- Open-ended card slot; use with p.c. card of any width
- Wide range of contact terminations
- Sizes 17, 23, 29, 35, 41
- For 1/16" or 3/32" p.c. card
- Mates with Series 7023 Plug

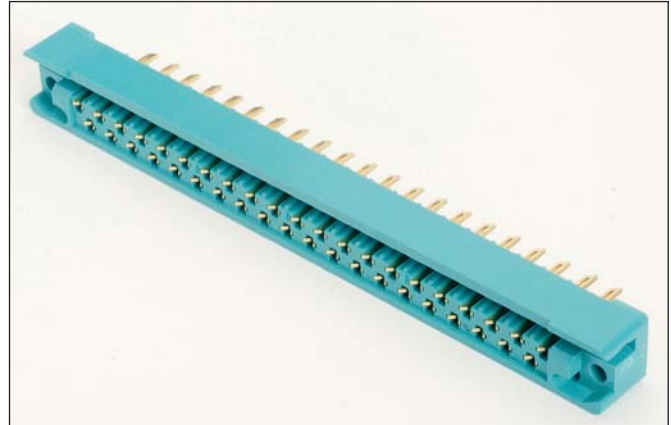

TECHNICAL SPECIFICATIONS

Current Rating:
10 amperes

Contact Resistance:
6 milliohms, maximum

Contact Material and Plating:
Phosphor Bronze per QQ-B-750, Composition A.

Gold, 10 microinches minimum, over nickel, 30 to 100 microinches

Insulator Material:
Diallyl phthalate, glass-filled, flame resistant, per MIL-M-14F, Type SDGF.

Insulation Resistance:
25,000 megohms, minimum

Dielectric Withstanding Voltage:
Sea Level: 1800 Volts rms
3.4" Hg: 675 Volts rms

Insertion/Withdrawal Force:
2 to 16 ounces per contact

Operating Temperature:
-40°C to +120°C

ORDERING CODE

00

7024

023

163

001

Number of Contacts
017, 023, 029, 035, 041

Contact Code
See table.

Variation Code
001 = 1/16" Thick Card
002 = 3/32" Thick Card
110 = 1/16" Thick Card 50 mil Gold
111 = 3/32" Thick Card 50 mil Gold

141 = 60 7001 06 33
P.C. Termination for 1/8" Card



156 = 60 7001 18 13
Wire wrapping (.026 x .062 x .600")



163 = 60 7001 19 13
.098" Base Taper Tab w/Wire Hole



166 = 60 7001 20 23
Dual Solder Termination for 2 Wires or Bus Line
(.056 x .125" Slot)



Connector Description	Availability				
	17	23	29	35	41
For 1/16" Card	X	X	X	X	X
For 3/32" Card	X	X	X	X	X

Series 7024 – 0.100" Staggered Dual Row

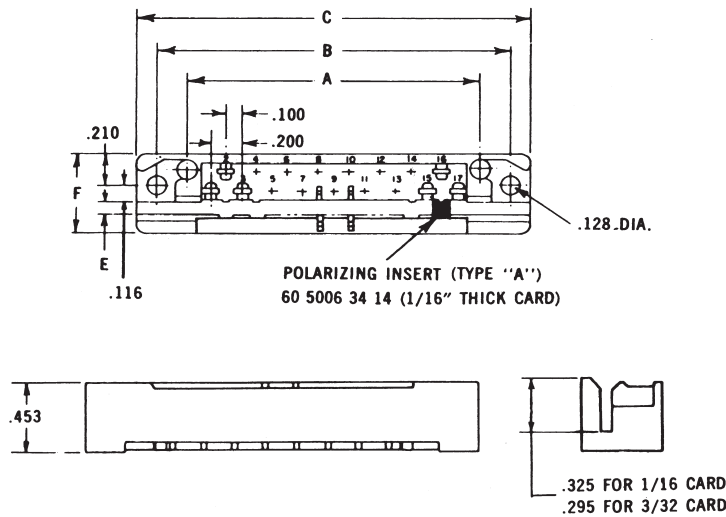

DIMENSIONS:

millimeters (inches)

Number of Contacts	A	B	C Max.	D	E $\pm .003$ / $\pm .002$		F	G††		H	N††	
					1/16" Card	3/32" Card		Con.	N-Con.		Con.	N-Con.
17	1.900 (0.075)	2.300 (0.091)	2.570 (0.101)	1.185 (0.072)	.074 (0.003)	.105 (0.004)	17/32"	.468 (0.018)	.343 (0.014)	1.600 (0.063)	.208 (0.008)	.146 (0.006)
23	2.500 (0.098)	2.900 (0.114)	3.170 (0.125)	2.435 (0.096)	.074 (0.003)	.105 (0.004)	17/32"	.468 (0.018)	.343 (0.014)	2.200 (0.087)	.208 (0.008)	.146 (0.006)
29	3.100 (0.122)	3.500 (0.138)	3.770 (0.148)	3.035 (0.119)	.074 (0.003)	.105 (0.004)	17/32"	.468 (0.018)	.343 (0.014)	2.800 (0.110)	.208 (0.008)	.146 (0.006)
35	3.700 (0.146)	4.100 (0.161)	4.370 (0.172)	3.635 (0.143)	.074 (0.003)	.105 (0.004)	17/32"	.468 (0.018)	.343 (0.014)	3.400 (0.134)	.208 (0.008)	.146 (0.006)
41	4.300 (0.169)	4.700 (0.185)	4.970 (0.196)	4.235 (0.167)	.074 (0.003)	.105 (0.004)	17/32"	.468 (0.018)	.343 (0.014)	4.000 (0.157)	.208 (0.008)	.146 (0.006)

†† N-CON = Non-Conductive Chassis
(1/16" Clearance Around Contacts)

CON = Conductive Chassis
(1/8" Clearance Around Contacts)

MOUNTING LAYOUT

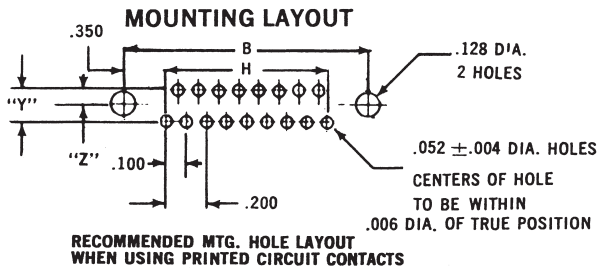

STANDARD CENTERS WHEN "Y" = .125; "Z" = .088

SPECIAL CENTERS WHEN "Y" = .150; "Z" = .100

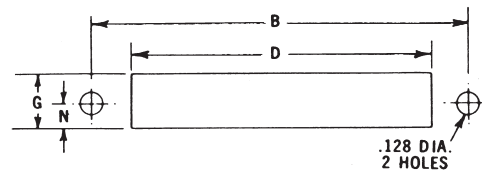

Varicon®

Series 7038 – 0.100"

Staggered Dual Row



FEATURES

- Varilok® contacts are insertable and removable by user
- Crimp, solderless wrap, tapered tab, and wire hole terminations available
- All crimping, insertion, and extraction equipment available (see page 26)
- Guide sockets facilitate mating, ensure correct alignment
- Open-ended card slot; no p.c. card notching necessary
- Mates with Series 7023 Plug

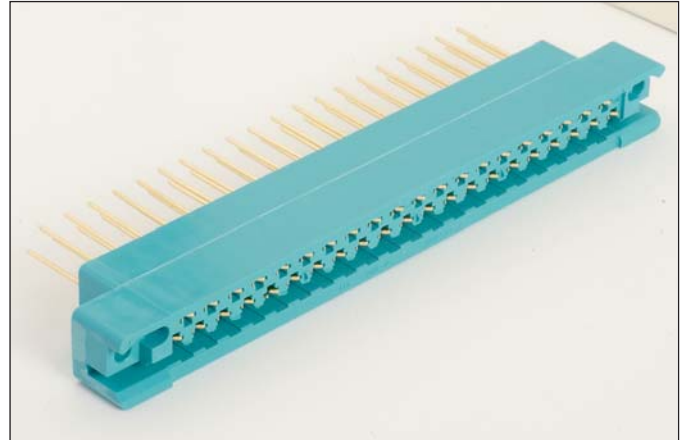

TECHNICAL SPECIFICATIONS

Current Rating:

8 amperes

Contact Resistance:

6 milliohms, maximum

Contact Material and Plating:

Phosphor Bronze

Gold, 10 microinches minimum, over nickel, 50 to 100 microinches

Insulator Material:

Diallyl phthalate, glass-filled, flame resistant, per MIL-M-14F, Type SDGF.

Insulation Resistance:

5,000 megohms, minimum

Dielectric Withstanding Voltage:

Sea Level: 1800 Volts rms

3.4" Hg: 675 Volts rms

Insertion/Withdrawal Force:

2 to 16 ounces per contact

Operating Temperature:

-40°C to +120°C

ORDERING CODE

00

7038

023

000

001

Number of Contacts

017, 023, 029,
035, 041

Contact Code

See table.

Variation Code

001 = 1/16" Thick Card
002 = 3/32" Thick Card
110 = 1/16" Thick Card 50 mil Gold
111 = 3/32" Thick Card 50 mil Gold

217 = 60 8017 05 13	
Wire Hole	
218 = 60 8017 06 13	
Solderless Wrap Tail – .025" x .050" x .567"	
750 = 60 8017 06 23	
Solderless Wrap Tail – .025" x .050" x .760"	
296 = 60 8017 06 33	
Solderless Wrap Tail – .025" x .025" x .580"	
504 = 60 8017 06 63	
Solderless Wrap Tail – .025" x .025" x .170"	
*000 = 60 8017 03 13	
Wire Crimp Tail (Contacts Loose) 18-26 AWG	
*000 = 60 8017 03 23	
Wire Crimp Tail (Contacts on a Reel) 18-26 AWG	

*Order separately by part number, refer to page 25

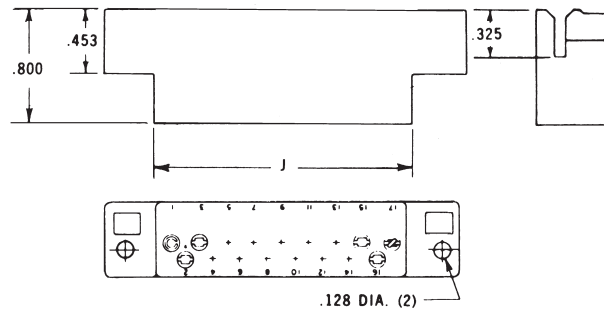
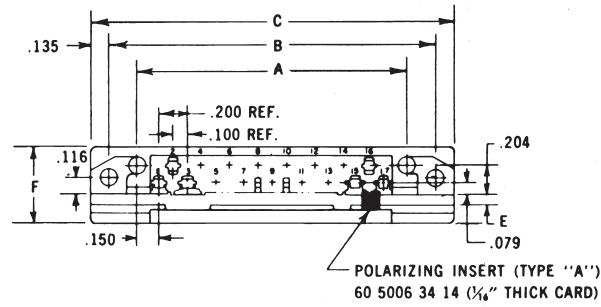

DIMENSIONS:

millimeters (inches)

Number of Contacts	A	B	C Max.	D	E		F	G	J
					1/16" Card	3/32" Card			
17	1.900 (0.075)	2.300 (0.091)	2.570 (0.101)	1.890 (0.075)	.074 (0.003)	.105 (0.004)	17/32"	.571 (0.022)	1.850 (0.073)
23	2.500 (0.099)	2.900 (0.114)	3.170 (0.125)	2.490 (0.098)	.074 (0.003)	.105 (0.004)	17/32"	.571 (0.022)	2.450 (0.096)
29	3.100 (0.122)	3.500 (0.138)	3.770 (0.148)	3.090 (0.121)	.074 (0.003)	.105 (0.004)	17/32"	.571 (0.022)	3.050 (0.120)
35	3.700 (0.146)	4.100 (0.161)	4.370 (0.172)	3.690 (0.145)	.074 (0.003)	.105 (0.004)	17/32"	.571 (0.022)	3.650 (0.144)
41	4.300 (0.169)	4.700 (0.185)	4.970 (0.196)	4.290 (0.169)	.074 (0.003)	.105 (0.004)	17/32"	.571 (0.022)	4.250 (0.167)

MOUNTING LAYOUT

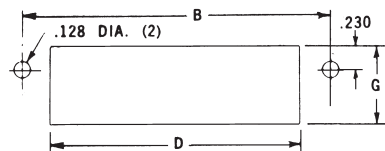

Series 8016 – .075" x .130" x .150" Grid Pattern

FEATURES

- Available in five sizes: 20, 38, 56, 90 and 120 contacts
- Insertable / removable Varilok contacts
- Crimp, solder, solderless wrap, and taper tab terminations
- Exceptional versatility: all hardware can be mounted on plug or receptacle (see ordering code)
- Actuating screw facilitates mating and unmating, locks mated connectors together
- Polarizing hardware can be set to any of six positions at factory; can also be reset by user (see polarizing code)
- Optional cover with top or side cable entry and clamp
- Optional cable strain relief clamp with adjustable strap for large or small cable bundles (fits on sizes 38 and 56)
- Plug and receptacle contacts are protected from mishandling
- Guide pins and sockets ensure correct alignment when mating
- Aluminum covers
- CSA acceptable polyester material



TECHNICAL SPECIFICATIONS

Current Rating:

8 amperes, maximum

Contact Resistance:

6 milliohms, maximum

Contact Material:

Phosphor bronze

Contact Plating:

Gold, 10 microinches min.,
over Nickel,
50-100 microinches

Insulator Material:

Thermoplastic 94V-O glass
filled polyester

Insulation Resistance:

5,000 megohms, min.
(polyester)

Sea Level: 1250 volts RMS

3.4" Hg: 625 volts RMS

Cover and Clamp Material and Finish:

Aluminum with clear chromate under grey
enamel finish

CONNECTORS:

Male



(Exposed Contacts)

Female



(Recessed Contacts)

Male, Jackscrew



001/601 Style

Male, Fixed Nut



002/602 Style

Female, Fixed Nut



007/607 Style

Female, Jackscrew



008/608 Style

COVERS:

Top Opening



Side Opening



**Top/side Opening
(Removable Side Plate)**



CONTACTS:

Crimp



Solder Tab



217 Style

**Wire Wrap
14.4mm**



218 Style

**Wire Wrap
19.3mm**



750 Style

**Wire Wrap
.567**



296 Style

Solder



504 Style

Series 8016 – Rectangular Connector – 20 Contact

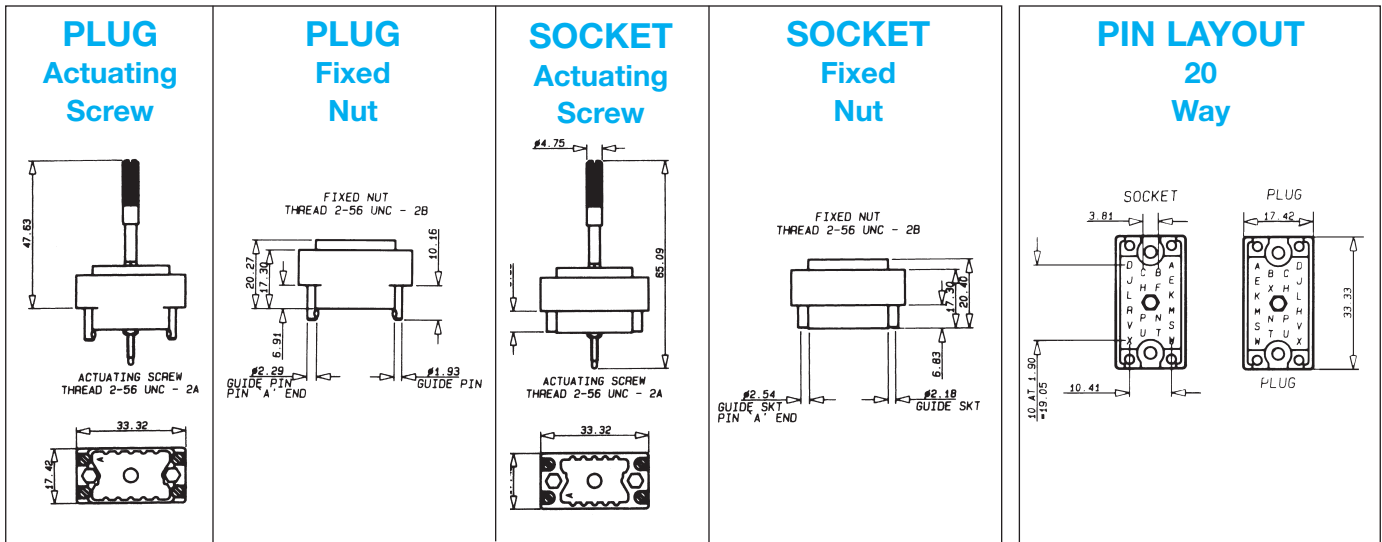

ORDERING CODE



Contact Termination

*000 = Contacts not fitted and ordered separately, see page 25 for full list of options

- 217 = Solder 0.098" x 2.49mm
- 218 = Wire Wrap -
 0.025 x 0.050 x 0.567" / 0.64 x 1.27 x 14.4mm
- 296 = Wire Wrap -
 0.025 x 0.026 x 0.579" / 0.64 x 0.66 x 14.7mm
- 504 = Solder Tail -
- 750 = Wire Wrap -
 0.025 x 0.050 x 0.760" / 0.64 x 1.27 x 19.3mm

*Crimp contacts always ordered separately. See page 25 for details.

RECOMMENDED LAYOUT FOR FRONT CHASSIS MOUNTING & PCB LAYOUT

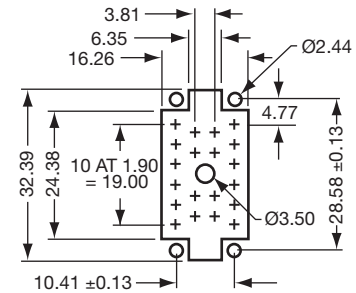

See page 26 for assembly tools.

20 CONTACTS					COVER			
Insulator Body Type	Basic P/N*	Color	Hardware **Thread	No Cover	Top Std Clamp	Side Std Clamp	Actuating Screw	Fixed Nut
Male	00 8016 020 000 XXX	Green	UNC	601	603	604	Y	N
Male	00 8016 020 000 XXX	Green	UNC	602	605	606	N	Y
Male	00 8016 020 000 XXX	Gray	UNC	001	903	904	Y	N
Male	00 8016 020 000 XXX	Gray	UNC	002	905	906	N	Y
Female	00 8016 020 000 XXX	Green	UNC	608	609	610	Y	N
Female	00 8016 020 000 XXX	Green	UNC	607	611	612	N	Y
Female	00 8016 020 000 XXX	Gray	UNC	008	909	910	Y	N
Female	00 8016 020 000 XXX	Gray	UNC	007	911	912	N	Y

*Select the column desired and replace the XXX with the numbers from column.

**United Course Thread

Series 8016 – Rectangular Connector – 38 Contact

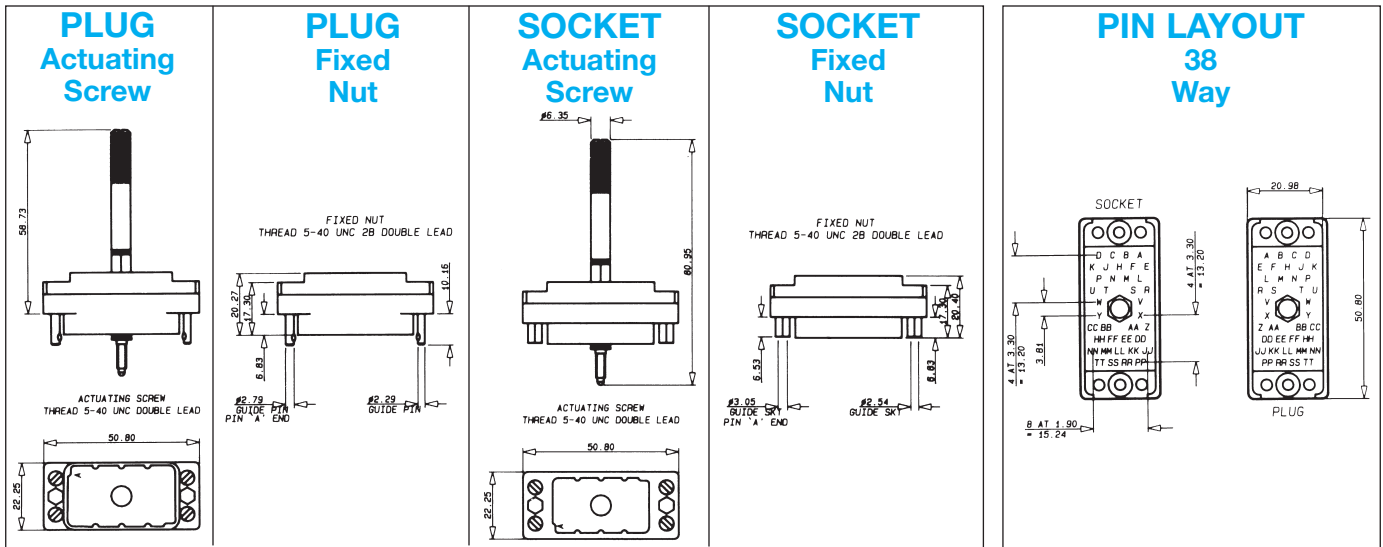

ORDERING CODE



Contact Termination	
*000 = Contacts not fitted and ordered separately, see page 25 for full list of options	
217 = Solder 0.098" x 2.49mm	
218 = Wire Wrap - 0.025 x 0.050 x 0.567" / 0.64 x 1.27 x 14.4mm	
296 = Wire Wrap - 0.025 x 0.026 x 0.579" / 0.64 x 0.66 x 14.7mm	
504 = Solder Tail -	
750 = Wire Wrap - 0.025 x 0.050 x 0.760" / 0.64 x 1.27 x 19.3mm	

*Crimp contacts always ordered separately. See page 25 for details.

RECOMMENDED LAYOUT FOR FRONT CHASSIS MOUNTING & PCB LAYOUT

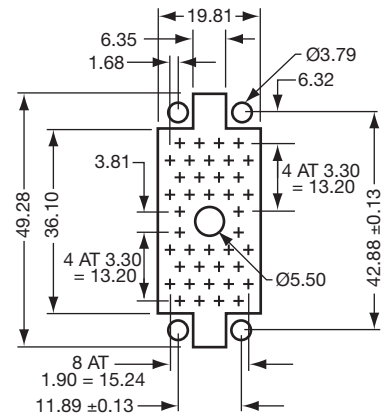

See page 26 for assembly tools.

38 CONTACTS						COVER							
Insulator Body Type	Basic P/N*	Color	Hardware **Thread	No Cover	Top Std Clamp	Side Std Clamp	Top Lge Clamp	Side Lge Clamp	Top EX Lge Clamp	Side EX Lge Clamp	Actuating Screw	Fixed Nut	
Male	00 8016 038 000 XXX	Green	UNC	601	603	604	619	620	631	632	Y	N	
Male	00 8016 038 000 XXX	Green	UNC	602	605	606	621	622	633	634	N	Y	
Male	00 8016 038 000 XXX	Gray	UNC	001	903	904	919	920	931	932	Y	N	
Male	00 8016 038 000 XXX	Gray	UNC	002	905	906	921	922	933	934	N	Y	
Female	00 8016 038 000 XXX	Green	UNC	608	609	610	623	624	635	636	Y	N	
Female	00 8016 038 000 XXX	Green	UNC	607	611	612	625	626	637	638	N	Y	
Female	00 8016 038 000 XXX	Gray	UNC	008	909	910	923	924	935	936	Y	N	
Female	00 8016 038 000 XXX	Gray	UNC	007	911	912	925	926	937	938	N	Y	

*Select the column desired and replace the XXX with the numbers from column.

**United Course Thread

Series 8016 – Rectangular Connector – 56 Contact

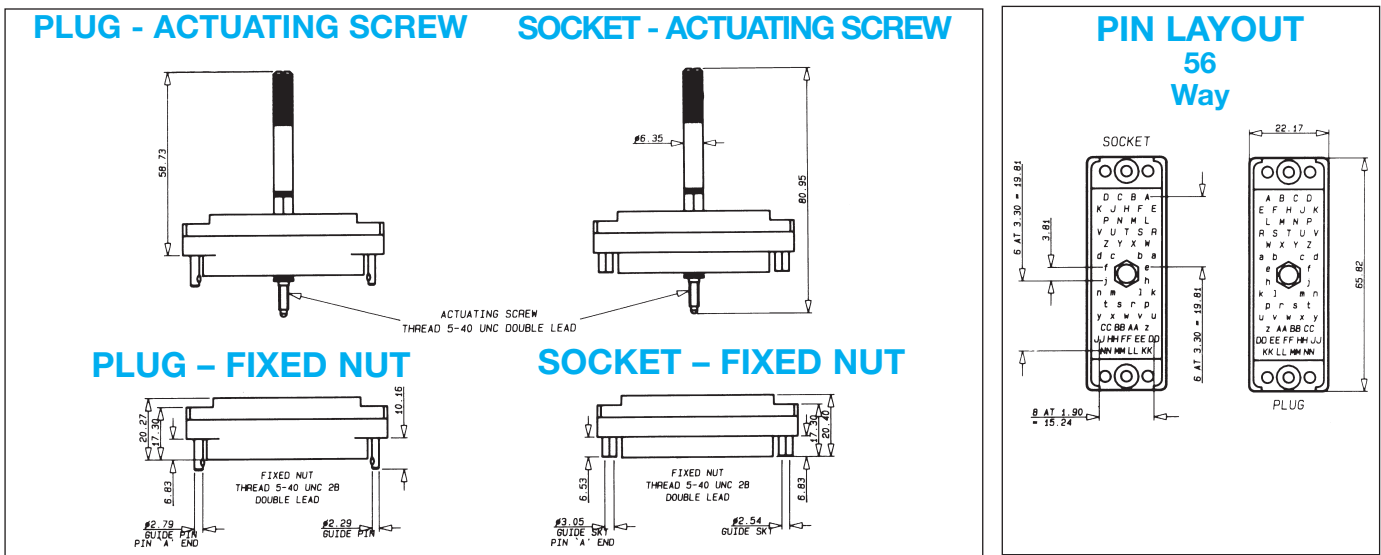

ORDERING CODE



Contact Termination	
*000	= Contacts not fitted and ordered separately, see page 25 for full list of options
217	= Solder 0.098" x 2.49mm
218	= Wire Wrap – 0.025 x 0.050 x 0.567" / 0.64 x 1.27 x 14.4mm
296	= Wire Wrap – 0.025 x 0.026 x 0.579" / 0.64 x 0.66 x 14.7mm
504	= Solder Tail –
750	= Wire Wrap – 0.025 x 0.050 x 0.760" / 0.64 x 1.27 x 19.3mm

*Crimp contacts always ordered separately.
See page 25 for details.

RECOMMENDED LAYOUT FOR FRONT CHASSIS MOUNTING & PCB LAYOUT

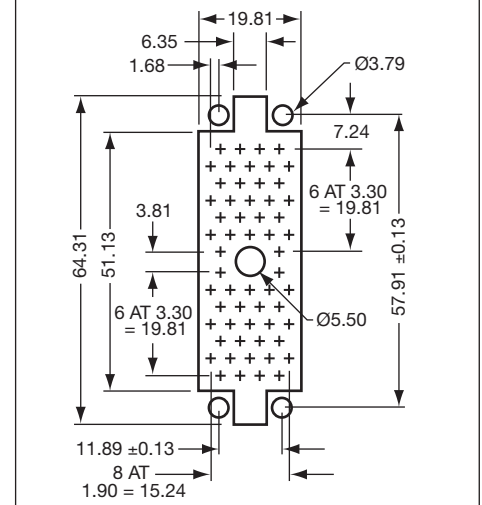

See page 26 for assembly tools.

56 CONTACTS						
Insulator Body Type	Basic P/N*	Color	Hardware **Thread	No Cover	Actuating Screw	Fixed Nut
Male	00 8016 056 000 XXX	Green	UNC	601	Y	N
Male	00 8016 056 000 XXX	Green	UNC	602	N	Y
Male	00 8016 056 000 XXX	Gray	UNC	001	Y	N
Male	00 8016 056 000 XXX	Gray	UNC	002	N	Y
Female	00 8016 056 000 XXX	Green	UNC	608	Y	N
Female	00 8016 056 000 XXX	Green	UNC	607	N	Y
Female	00 8016 056 000 XXX	Gray	UNC	008	Y	N
Female	00 8016 056 000 XXX	Gray	UNC	007	N	Y

*Select the column desired and replace the XXX with the numbers from column.
**United Course Thread

Series 8016 – Rectangular Connector – 90 Contact

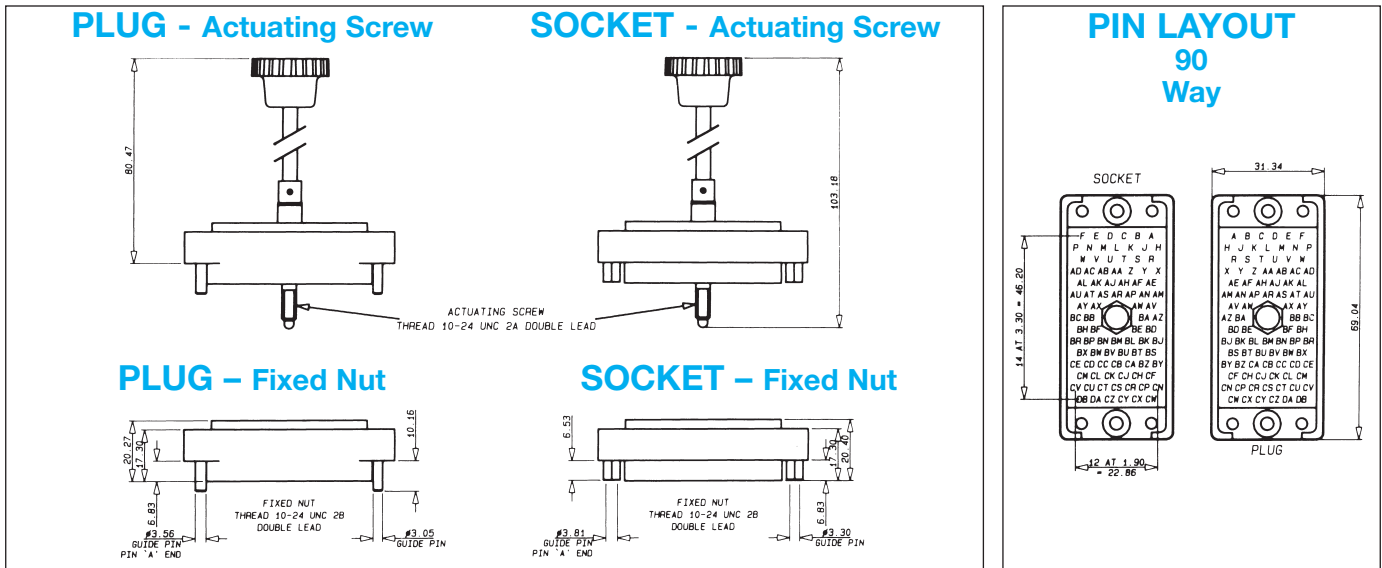

ORDERING CODE



Contact Termination

*000 = Contacts not fitted and ordered separately, see page 25 for full list of options

217 = Solder 0.098" x 2.49mm

218 = Wire Wrap –
0.025 x 0.050 x 0.567" / 0.64 x 1.27 x 14.4mm

296 = Wire Wrap –
0.025 x 0.026 x 0.579" / 0.64 x 0.66 x 14.7mm

504 = Solder Tail –

750 = Wire Wrap –
0.025 x 0.050 x 0.760" / 0.64 x 1.27 x 19.3mm

*Crimp contacts always ordered separately. See page 25 for details.

RECOMMENDED LAYOUT FOR FRONT CHASSIS MOUNTING & PCB LAYOUT

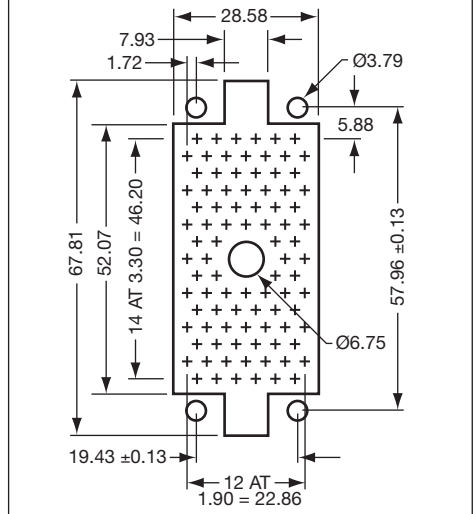

See page 26 for assembly tools.

90 CONTACTS					COVER				Actuating Screw	Fixed Nut
Insulator Body Type	Basic P/N*	Color	Hardware **Thread	No Cover	Top Lge Clamp	Side Lge Clamp	Top EX Lge Clamp	Side EX Lge Clamp		
Male	00 8016 090 000 XXX	Green	UNC	601	603	604	631	632	Y	N
Male	00 8016 090 000 XXX	Green	UNC	602	605	606	633	634	N	Y
Male	00 8016 090 000 XXX	Gray	UNC	001	903	904	931	932	Y	N
Male	00 8016 090 000 XXX	Gray	UNC	002	905	906	933	934	N	Y
Female	00 8016 090 000 XXX	Green	UNC	608	609	610	635	636	Y	N
Female	00 8016 090 000 XXX	Green	UNC	607	611	612	637	638	N	Y
Female	00 8016 090 000 XXX	Gray	UNC	008	909	910	935	936	Y	N
Female	00 8016 090 000 XXX	Gray	UNC	007	911	912	937	938	N	Y

*Select the column desired and replace the XXX with the numbers from column.

**United Course Thread

Series 8016 – Rectangular Connector – 120 Contact

PLUG - ACTUATING SCREW SOCKET - ACTUATING SCREW

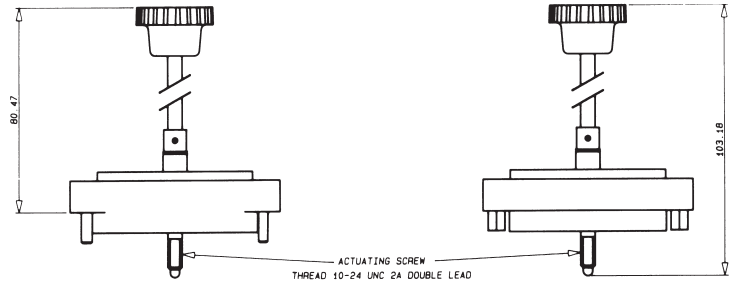

PLUG – Fixed Nut

SOCKET – FIXED NUT

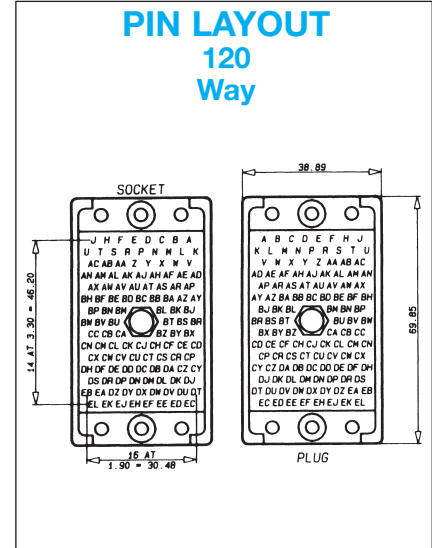
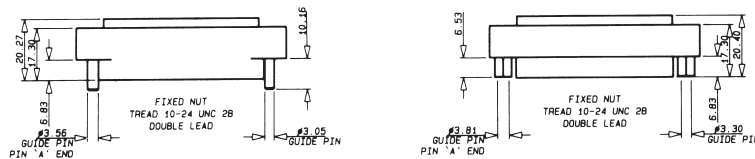

ORDERING CODE



Contact Termination	
*000 = Contacts not fitted and ordered separately, see page 25 for full list of options	
217 = Solder 0.098" x 2.49mm	
218 = Wire Wrap – 0.025 x 0.050 x 0.567" / 0.64 x 1.27 x 14.4mm	
296 = Wire Wrap – 0.025 x 0.026 x 0.579" / 0.64 x 0.66 x 14.7mm	
504 = Solder Tail –	
750 = Wire Wrap – 0.025 x 0.050 x 0.760" / 0.64 x 1.27 x 19.3mm	

*Crimp contacts always ordered separately. See page 25 for details.

RECOMMENDED LAYOUT FOR FRONT CHASSIS MOUNTING & PCB LAYOUT

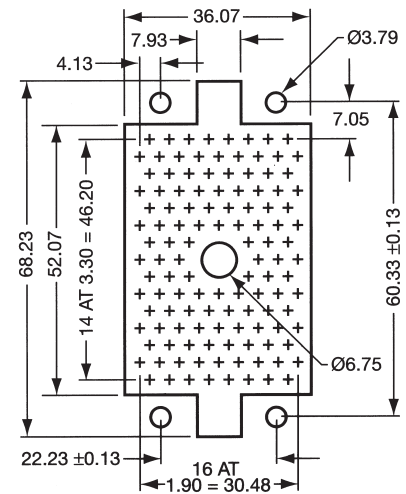

See page 26 for assembly tools.

120 CONTACTS					COVER			
Insulator Body Type	Basic P/N*	Color	Hardware **Thread	No Cover	Top Lge Clamp	Side Lge Clamp	Actuating Screw	Fixed Nut
Male	00 8016 120 000 XXX	Green	UNC	601	603	604	Y	N
Male	00 8016 120 000 XXX	Green	UNC	602	605	606	N	Y
Male	00 8016 120 000 XXX	Gray	UNC	001	N/A	N/A	Y	N
Male	00 8016 120 000 XXX	Gray	UNC	002	N/A	N/A	N	Y
Female	00 8016 120 000 XXX	Green	UNC	608	609	610	Y	N
Female	00 8016 120 000 XXX	Green	UNC	607	611	612	N	Y
Female	00 8016 120 000 XXX	Gray	UNC	008	N/A	N/A	Y	N
Female	00 8016 120 000 XXX	Gray	UNC	007	N/A	N/A	N	Y

*Select the column desired and replace the XXX with the numbers from column.

**United Course Thread

Series 8016 Covers

Part Number	For Size	Hardware Threads	Cable Entrance	Clamp Type	Size mm (inches)
30 8016 9829 00 000	20	Metric	Side	Standard	11.53 (0.454) Dia
30 8016 9831 00 000	20	Metric	Top	Standard	11.53 (0.454) Dia
30 8016 0200 00 415	20	UNC	45	Standard	5 x 10 (0.197 x 0.394) min
30 8016 9821 00 000	38	Metric	Side	Standard	16.51 x 12.70 (0.650 x 0.500)
30 8016 9822 00 000	38	Metric	Top	Standard	16.51 x 12.70 (0.650 x 0.500)
30 8016 9825 00 000	38	Metric	Side	Large	16.51 x 15.44 (0.650 x 0.608)
30 8016 9826 00 000	38	Metric	Top	Large	16.51 x 15.44 (0.650 x 0.608)
30 8016 9838 00 000	38	Metric	Side	Ex-Large	20.83 x 15.60 (0.820 x 0.614)
30 8016 9839 00 000	38	Metric	Top	Ex-Large	20.83 x 15.60 (0.820 x 0.614)
30 8016 0560 00 413	56	UNC	Top/Side	Standard	6 x 14 (0.236 x 0.551) min
30 8016 9832 00 000	90	Metric	Side	Large	20.32 (0.800) Dia
30 8016 9833 00 000	90	Metric	Top	Large	20.32 (0.800) Dia
30 8016 9843 00 000	90	Metric	Side	Ex-Large	25.40 x 20.32 (1.00 x 0.800)
30 8016 9844 00 000	90	Metric	Top	Ex-Large	25.40 x 20.32 (1.00 x 0.800)
30 8016 9834 00 000	120	Metric	Side	Large	20.32 x 27.43 (0.800 x 1.080)
30 8016 9835 00 000	120	Metric	Top	Large	20.32 x 27.43 (0.800 x 1.080)

Series 8016 Covers

CLAMPING AND COVER DIMENSIONS OPTIONAL REMOVABLE SIDE PLATE COVER 20 CONTACTS

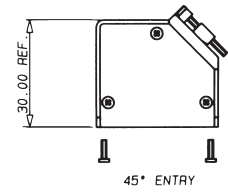
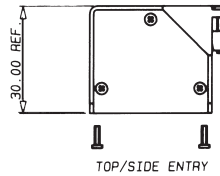
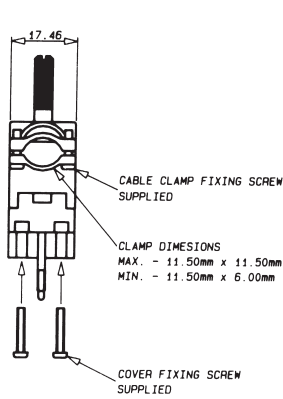
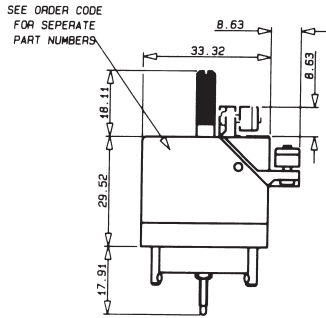

Part Number	Opening
308016020000413	Side/Top
308016020000415	45°

CLAMP	
Minimum Size	Maximum Size
5 x 10 (0.197 x 0.394)	10 x 10 (0.394 x 0.394)
5 x 10 (0.197 x 0.394)	10 x 10 (0.394 x 0.394)

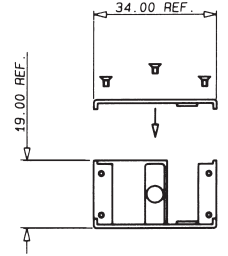

38 CONTACTS

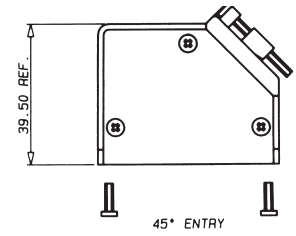
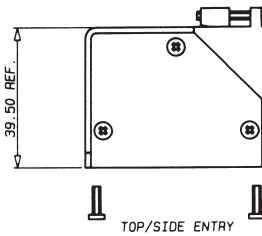
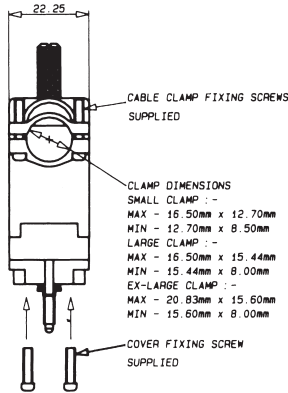
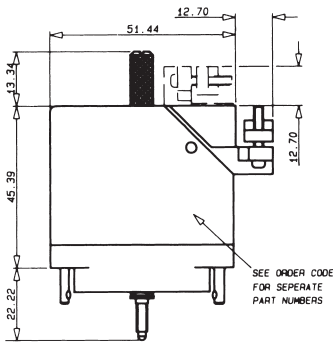

Part Number	Opening
308016038000413	Side/Top
308016038000415	45°

CLAMP	
Minimum Size	Maximum Size
6 x 14 (0.236 x 0.551)	17 x 14 (0.669 x 0.551)
6 x 14 (0.236 x 0.551)	17 x 14 (0.669 x 0.551)

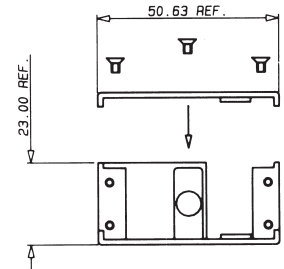

56 CONTACTS

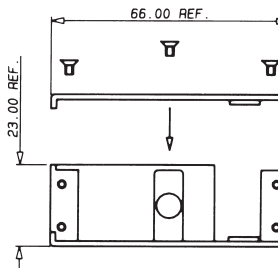
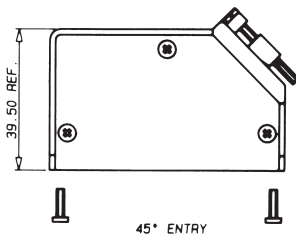

Part Number	Opening
308016056000413	Side/Top

CLAMP	
Minimum Size	Maximum Size
6 x 14 (0.236 x 0.551)	17 x 14 (0.669 x 0.551)
6 x 14 (0.236 x 0.551)	17 x 14 (0.669 x 0.551)

CLAMPING AND COVER DIMENSIONS

90 CONTACTS

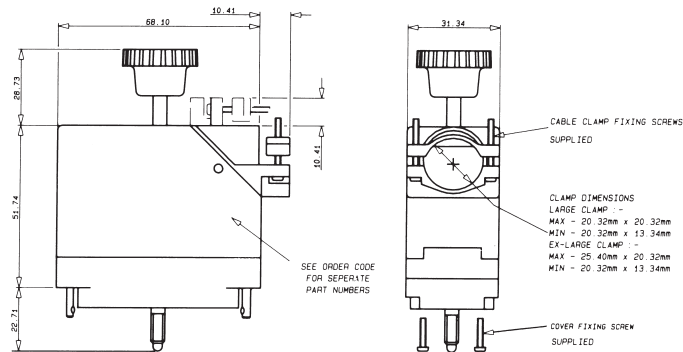

120 CONTACTS

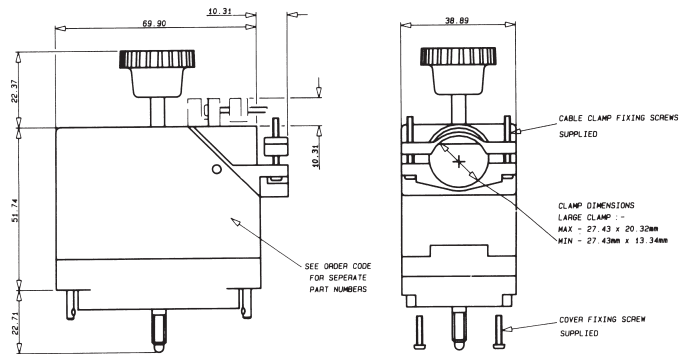

See page 21 for part numbers

75/100/130 CONTACTS

Plug with Actuating Screw 001

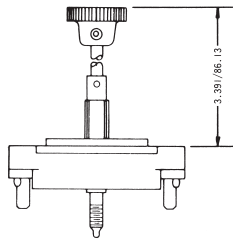

Receptacle with Fixed Nut 007

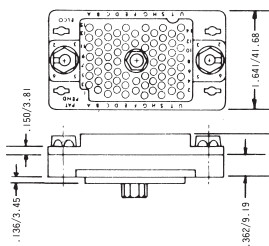

Plug with Fixed Screw 002

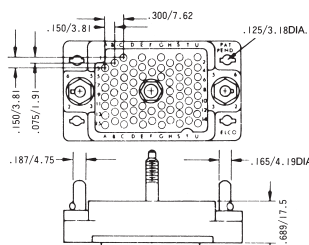

Receptacle with Actuating Nut 008

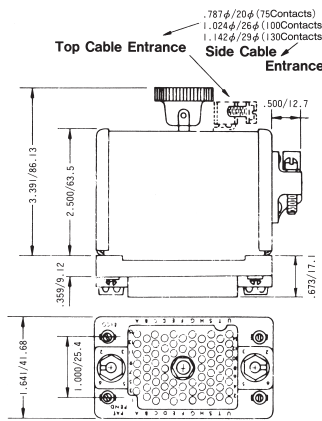

75 CONTACTS

Plug

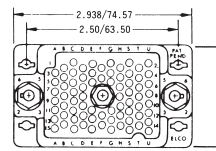

Receptacle

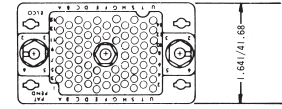

100 CONTACTS

Plug

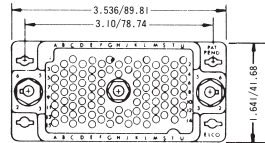

Receptacle

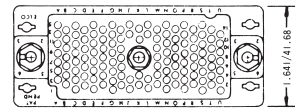

130 CONTACTS

Plug

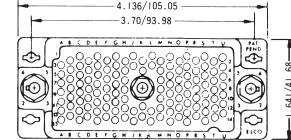

Receptacle

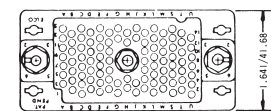

ORDERING CODE



RECOMMENDED CHASSIS LAYOUT

Layout for Front Chassis Mounting

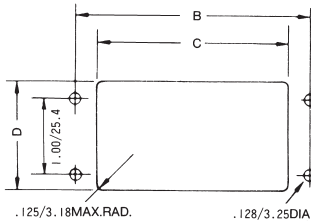

Layout for Back Chassis Mounting

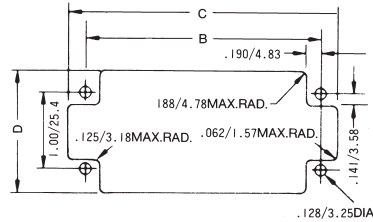

All Tolerances $\pm .005 \pm .127$

No. of Pos.	Front Chassis Mtg.			Back Chassis Mtg.		
	B	C	D	B	C	D
75	2.500/63.50	1.953/49.61	1.437/36.50	2.500/63.50	2.953/75.00	1.656/42.06
100	3.100/78.74	2.546/64.67	1.437/36.50	3.100/78.74	3.562/90.47	1.656/42.06
130	3.700/93.98	3.156/80.16	1.437/36.50	3.700/93.98	4.156/105.56	1.656/42.06

Dimensions inches/mm

VARIATION CODE

Insulator Body Type	Variation Code No.	Cover & Cable Entrance	Actuating Screw	Fixed Screw
Plug	001	No	Yes	No
	002	No	No	Yes
	003	Top	Yes	No
	004	Side	Yes	No
	005	Top	No	Yes
	006	Side	No	Yes

Insulator Body Type	Variation Code No.	Cover & Cable Entrance	Fixed Nut	Actuating Nut
Receptacle	007	No	Yes	No
	008	No	No	Yes
	009	Top	Yes	No
	010	Side	Yes	No
	011	Top	No	Yes
	012	Side	No	Yes







CONNECTOR PLUG AND RECEPTACLE COMBINATIONS

Plug \ Receptacle	Receptacle					
	007	008	009	010	011	012
001						
002						
003						
004						
005						
006						

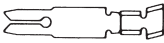
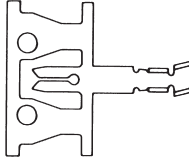
Loose Contacts

Varilok® connectors can be specified as either fully loaded, to include the connector body and a variety of pre-loaded contact termination types or the empty body and a selection

of separately specified and ordered contacts. The table below details the various loose contacts available.

Contact Style	Description	Plating Specification	Order Code
 <p>* Ordered separately</p>	Crimp Contact Loose	0.25µM Gold All Over (Standard) 0.25µM Gold Nose & Tail (Optional)	60 8017 0313 00 339 60 8017 0313 00 042
 <p>Ordered separately</p>	Crimp Contact End Carrier (1800 Contacts per reel)	0.25µM Gold All Over (Standard) 0.25µM Gold Nose & Tail (Optional) 0.25µM Gold All Over (Standard) 0.25µM Gold Nose & Tail (Optional)	60 8017 0323 99 339 60 8017 0323 99 042 60 8017 0323 00 339** 60 8017 0323 00 042**
<p>Tail Section – 2.49 x 0.61 (0.098 x 0.024)</p>  <p>* If fitted type 217</p>	Solder Tag Contact	0.25µM Gold All Over (Standard)	60 8017 0513 00 339
<p>Tail Section – 1.27 x 0.63 (0.025 x 0.005)</p>  <p>If fitted type 218</p>	14.4mm Maxiwrap Contact	0.25µM Gold All Over (Standard)	60 8017 0613 00 339
<p>Tail Section – 1.27 x 0.63 (0.025 x 0.005)</p>  <p>If fitted type 750</p>	19.3mm Maxiwrap Contact	0.25µM Gold All Over (Standard)	60 8017 0623 00 339
<p>Tail Section – 0.635 x 0.63 (0.025 x 0.005)</p>  <p>If fitted type 296</p>	14.0 Miniwrap Contact	0.25µM Gold All Over (Standard)	60 8017 0633 00 339
<p>Tail Section – 0.635 x 0.63 (0.025 x 0.005)</p>  <p>* If fitted type 504</p>	4.3mm PC Solder Contact for ø 1.00 mm P.T.H.	0.25µM Gold All Over (Standard)	60 8017 0663 00 339

* Indicates standard contact

Plating code 343 = 0.50 µm Gold all over

** Order code to be used when purchasing through a USA source.

CONNECTOR POLARIZATION

Varicon® 8016 Series connectors are designed with an integral polarizing system to ensure in high density environments that the correct halves are mated together.

As a factory standard, male plugs are set to the code PG1G1, with the female receptacles being set to the opposite matching code RS1S1.

Customers who need to change the standard polarization to another position can do so by ordering the connectors with the required polarization (eg: PG1G4 or RS2S5, etc) When ordering a different polarization from normal, the polarization is called out at the end of the part number (Ex: 00 8016 056 000 601PG2G4, etc).

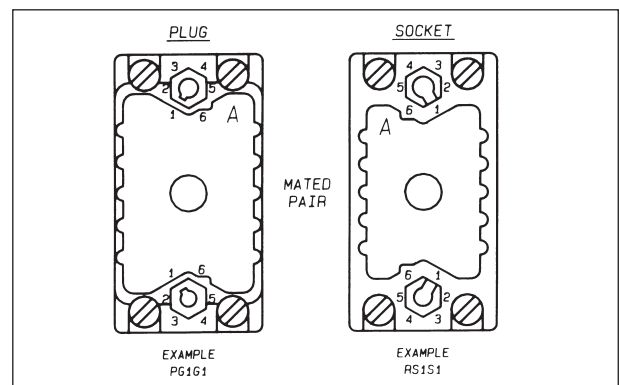

ORDERING CODE

P
Type of Connector Half
Plug = P
Socket = R

G
Location Side (Large Dia.)
Guide Pin = G
Guide Socket = S

1
Positions
1 through 6

G
Location Side (Small Dia.)
Guide Pin = G
Guide Socket = S

1
Positions
1 through 6

Tools

CONTACT INSERTION TOOLS

These are small hand tools which provide a positive method for inserting contacts into the rear of the insulator by applying pressure on the contacts directly to the end of the insulation crimp.

Tool	Contact Capability	Connector Series
06 1742 0400 00 000	Varilok®	
	No. 60 8017 Contact Family	7038, 8016, 8017, 8020



HAND CRIMP TOOLS

This tool is designed for hand crimping of contacts. The tool is well suited for maintenance, model shop, laboratory and small scale production purposes. Two crimping cavities are available; Upper Cavity will crimp wire 18-20 AWG and the Lower Cavity will crimp wire 22-26 AWG.



Part No.	Contact Capability	Wire Type & Size
06 7852 0100 00 000 (Standard)	Varilok®	Stranded AWG
	No. 60 8017 0313	No. 18-26
06 7852 7002 01 000 (Blue Handle)	Varilok®	Stranded AWG
	No. 60 8017 0313	No. 18-26
06 7858 01 000 0000	Mini Varilok®	Stranded AWG
	No. 60 8216 0313	No. 22-30

CONTACT EXTRACTION TOOLS

This tool is designed to extract contacts from the front of the insulator quickly and easily, without damage to either contacts or insulator.



Tool	Contact Capability	Connector Series
06 1877 0400 00 000	Varilok®	
	No. 60 8017 Contact Family	7038, 8016, 8017, 8020
06 7699 01 000 0000	Mini Varilok®	
	No. 60 8216 Contact Family	8223

Series 8020 – Cable Connector

APPLICATION

In line connection of 2 or 3 wire of 18-26 AWG, insulation ϕ 1.03 mm to 1.88 mm.

FEATURES AND BENEFITS

- 2 and 3 position in single row
- Uses identical molding for plug and socket
- Uses identical contact for plug and socket
- Uses standard Varicon 8016 contacts
- Uses standard Varicon Crimping Tools, Contact Extraction Tools and Insertion Tools
- Has combined nylon mounting and locking clip common to both sizes
- Contacts for both solder and crimp termination

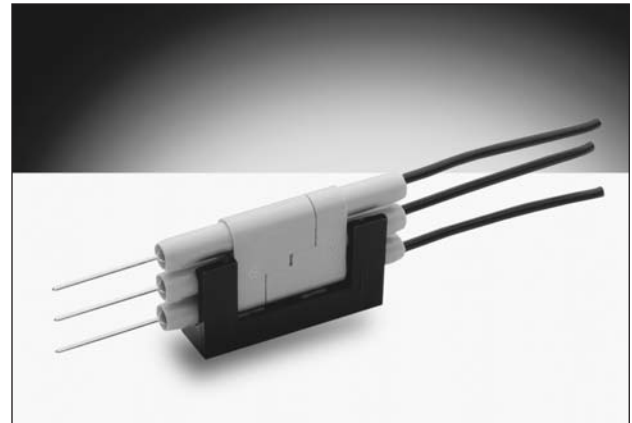

TECHNICAL SPECIFICATIONS

Contact:

Single row of 2 or 3 Varilok contacts

Contact Rating:

8.5 amperes

Insulation Resistance:

5,000 megohms (min)

Configuration:

On a 0.200 inch pitch, 5.08 mm

Contact Resistance:

6 milliohms (max)

Voltage Proof:

2,500 volts R.M.S. Sea Level

CONNECTOR DIMENSIONS (mm)

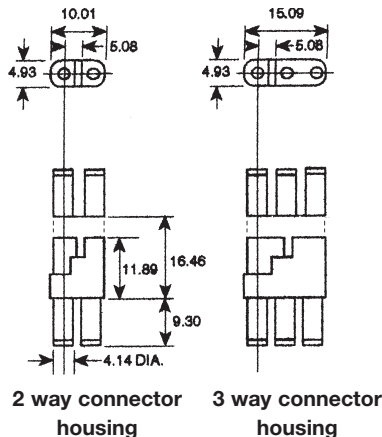

LOCKING CLIP DIMENSIONS (mm)

P/N 608020321000000

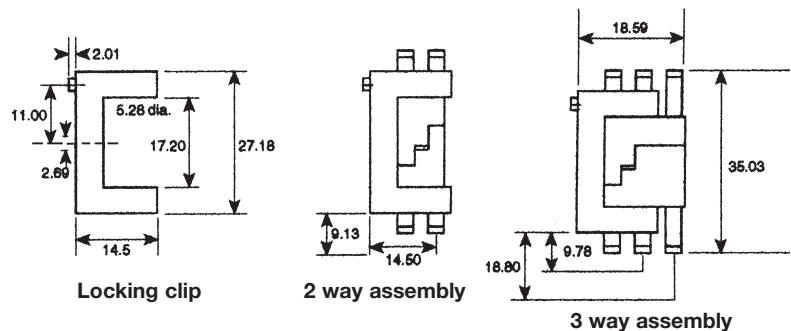

ORDERING CODE FOR COMPLETE CONNECTORS WITH NON-CRIMP CONTACTS FITTED

00	8020	002	217	001
Prefix	Series Number	Number of Contacts	*Contact Termination	Variation Code
		002 = Two way 003 = Three way	000 = Crimp Contacts (Ordered Separately) 217 = Solder Tag 218 = Wire Wrap (0.61 x 1.27 x 14.4mm) 296 = Mini Wire Wrap (0.61 x 0.66 x 4.73mm) 504 = Solder Tail (0.61 x 0.66 x 4.32mm)	

*Contact terminations should be insulated because they may protrude from the insulator.

NB: See page 25 for details of contacts.

ORDERING CODE FOR HOUSINGS AND CRIMP CONTACTS

Description	Part Number	Description	Part Number
2 way connector: Housing only	60-8020-3117-00-000	0.25 μ M Gold reeled crimp contacts (gold all over)	60-8017-0323-99-339
3 way connector: Housing only	60-8020-3317-00-000	0.25 μ M Gold reeled crimp contacts (selective)	60-8017-0323-99-042
0.25 μ M Gold loose crimp contacts (gold all over)	60-8017-0313-00-339	NB: See page 25 for details of crimp contacts	
0.25 μ M Gold loose crimp contacts (selective)	60-8017-0313-00-042	Locking clip	60-8020-3210-00-000

Series 8218 – 0.050" Staggered Dual Row

FEATURES

- High contact density
- For parallel or perpendicular p.c. card mounting
- High mounting density (.050" centers, minimum)
- Nylon end sections for mounting and card guidance
- Mounting hardware supplied with connector
- Mates with 8219 Series

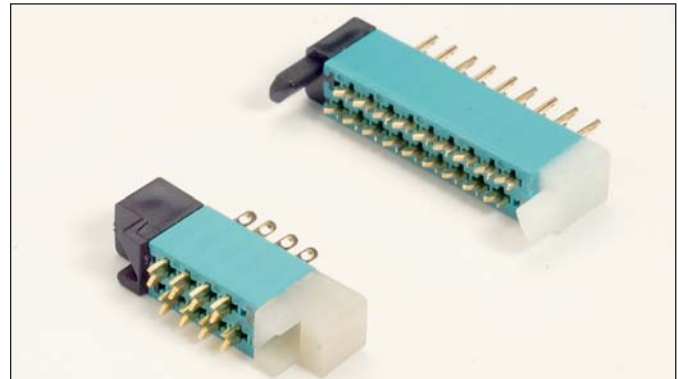

TECHNICAL SPECIFICATIONS

Current Rating:

5 amperes, maximum

Contact Resistance:

0.005 ohm, maximum

Contact Material and Plating:

Phosphor Bronze
nickel plate, 30 to 50 microinches followed by
gold plate, 10 to 20 microinches

Insulator Material:

Diallyl phthalate, glass-filled, flame resistant,
end guides: nylon

Insulation Resistance:

5,000 megohms, minimum

Dielectric Withstanding Voltage:

Sea Level: 1000 Volts rms
3.4" Hg: 500 Volts rms

Insertion/Withdrawal Force:

2 to 16 ounces per contact

ORDERING CODE

00

8218

076

000

001

Number of Contacts

002 to 076 for connectors
without center guide

Contact Code

Variation Code

001 = Receptacle
002 = Plug-Card
005 = Plug-Board

with keying pins

011 = Receptacle
012 = Plug-Card/pin
inserted in
odd position
013 = Plug-Card/pin
inserted in even
position
017 = Plug-Board

with keying holes

021 = Receptacle
022 = Plug-Card/pin
inserted in
odd position
023 = Plug-Card/pin
inserted in even
position
027 = Plug-Board

Variant 002 right angled contacts

000 = 60 8200 16 33 P.C. Tail

000 = 60 8200 16 63 P.C. Tail

Variants 001 and 005

722 = 60 8200 16 13 Wire Hole Tail

736 = 60 8200 16 33 P.C. Tail (X = 9/32", Y = 1/4")

753 = 60 8200 16 53 P.C. Tail (X = 1/8", Y = 3/32")

771 = 60 8200 16 63 P.C. Tail (X = 31/64", Y = 29/64")

Series 8218 – 0.050" Staggered Dual Row

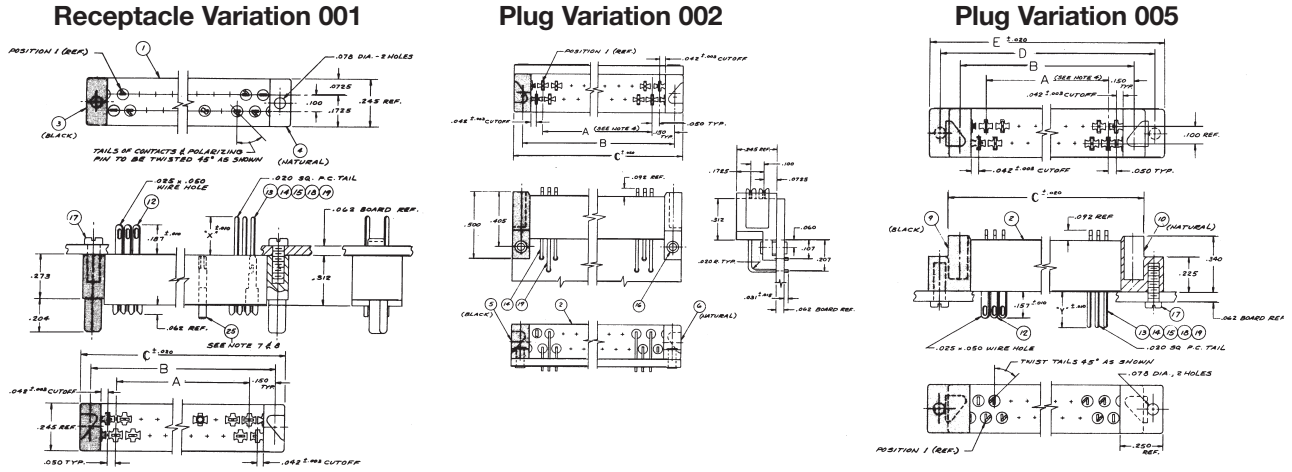

RECEPTACLE 001 – MATES WITH PLUGS 002 AND 005

MOUNTING LAYOUT

Variation 001 and 005

Variation 002

Minimum Center to Center Spacing for Adjustment Plugs

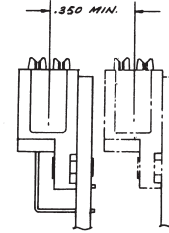
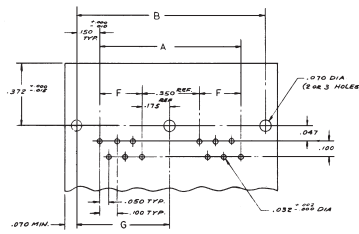
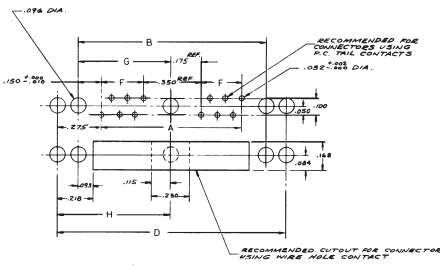

DIMENSIONS

(inches)

A	B	C	D	E
(No. of contacts x 0.050") - 0.050"	"A" dimension + 0.300"	"A" dimension + 0.440"	"A" dimension + 0.550"	"A" dimension + 0.690"

POLARIZATION

Keying Ordering No.
60-8218-4715-00-152



Determine polarization pin location from views.

P = Specify location by contact # where polarizing pin must be inserted.

H = Specify location by contact # where contact must be omitted for mating.

Typical Example: 00-8218-024-721-001-P17 (polarizing pin mtd. in position 17)
00-8218-024-721-005-H17 (polarizing hole is in position 17)

Series 8219 – 0.050" Staggered Dual Row

FEATURES

- For p.c. card-to-card applications
- High contact density
- Low withdrawal force contacts
- Rugged, color coded end guides
- Parallel or perpendicular p.c. board mounting
- Mates with Series 8218

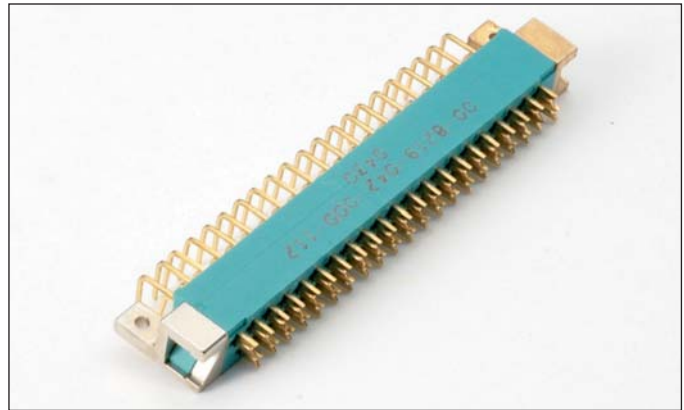

TECHNICAL SPECIFICATIONS

Current Rating:

5 amperes, maximum

Contact Resistance:

6 milliohms, maximum

Contact Material and Plating:

Phosphor Bronze

Gold, 10 microinches minimum,
over nickel, 50 to 100 microinches

Insulator Material:

Diallyl phthalate, glass-filled, flame resistant per MIL-M-14F, Type SDGF.

Guidance Hardware:

Left hand guides: Metal, gold color
Right hand guides: Metal, silver color

Insulation Resistance:

5,000 megohms, minimum

Dielectric Withstanding Voltage:

Sea Level: 1000 Volts rms

3.4" Hg: 500 Volts rms

Insertion/Withdrawal Force:

2 to 8 ounces per contact

ORDERING CODE

00

8219

042

722

001

Number of Contacts
018, 030, 036, 042, 054, 072

Contact Code
(see below)

Variation Code

For Variation = 001			For Variation = 002																						
Code No.	Contact Type	"X" Dim.	Code No.	Contact Type																					
722	Wire hole tail	.187	000	P. C. solder tails formed																					
721	P. C. solder tail	.250	722	Wire hole tail unformed																					
736	P. C. solder tail	.281	For Variation = 005 <table border="1"> <thead> <tr> <th>Code No.</th> <th>Contact Type</th> <th>"Y" Dim.</th> </tr> </thead> <tbody> <tr> <td>722</td> <td>Wire hole tail</td> <td>.157</td> </tr> <tr> <td>721</td> <td>P. C. solder tail</td> <td>.219</td> </tr> <tr> <td>736</td> <td>P. C. solder tail</td> <td>.250</td> </tr> <tr> <td>737</td> <td>P. C. solder tail</td> <td>.531</td> </tr> <tr> <td>753</td> <td>P. C. solder tail</td> <td>.093</td> </tr> <tr> <td>771</td> <td>P. C. solder tail</td> <td>.453</td> </tr> </tbody> </table>		Code No.	Contact Type	"Y" Dim.	722	Wire hole tail	.157	721	P. C. solder tail	.219	736	P. C. solder tail	.250	737	P. C. solder tail	.531	753	P. C. solder tail	.093	771	P. C. solder tail	.453
Code No.	Contact Type	"Y" Dim.																							
722	Wire hole tail	.157																							
721	P. C. solder tail	.219																							
736	P. C. solder tail	.250																							
737	P. C. solder tail	.531																							
753	P. C. solder tail	.093																							
771	P. C. solder tail	.453																							
737	P. C. solder tail	.562																							
753	P. C. solder tail	.125																							
771	P. C. solder tail	.484																							

Without Keying	
001	= Receptacle
002	= Plug, parallel board mounting
005	= Plug, perpendicular board mounting

NOTE: Connector is supplied with mounting screws or eyelets, as applicable (see drawings).

Contact Factory for Special Variations.

POLARIZING SYSTEM

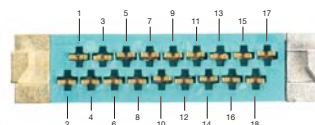

When Keying is ordered with part number, the Key is installed at the factory.

Series 8219 – 0.050" Staggered Dual Row

RECEPTACLE - VARIATION 001

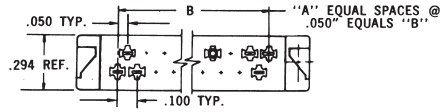
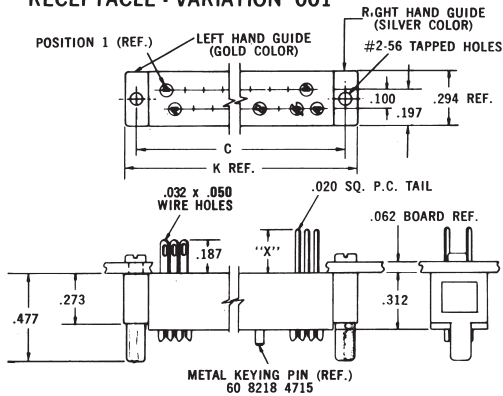

DIMENSIONS:

millimeters (inches)

Number of Contacts	A	B	C	Ref. D	E	F	G	Ref. K
18	17	.850 (0.033)	1.150 (0.045)	1.290 (0.051)	1.400 (0.055)	1.540 (0.061)	.964 (0.038)	1.300 (0.051)
30	29	1.450 (0.057)	1.750 (0.069)	1.890 (0.075)	2.000 (0.079)	2.140 (0.084)	1.564 (0.061)	1.900 (0.075)
36	35	1.750 (0.069)	2.050 (0.080)	2.190 (0.086)	2.300 (0.091)	2.440 (0.096)	1.864 (0.073)	2.220 (0.087)
42	41	2.050 (0.080)	2.350 (0.093)	2.490 (0.098)	2.600 (0.102)	2.740 (0.108)	2.164 (0.085)	2.500 (0.098)
54	53	2.650 (0.104)	2.950 (0.116)	3.090 (0.122)	3.200 (0.126)	3.340 (0.131)	2.764 (0.109)	3.100 (0.122)
72	71	3.550 (0.140)	3.850 (0.152)	3.990 (0.157)	4.100 (0.161)	4.240 (0.167)	3.664 (0.144)	4.000 (0.157)

RECEPTACLE 001 MATES WITH PLUGS 002 AND 005

PLUG - VARIATION 002

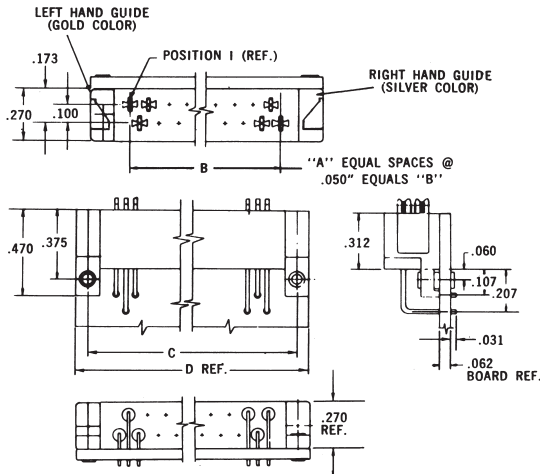

PLUG - VARIATION 005

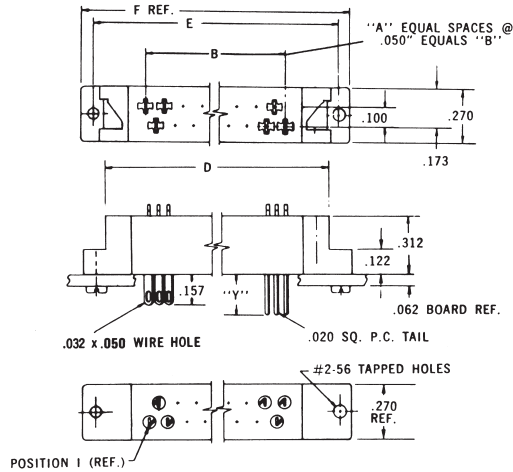

MOUNTING LAYOUTS

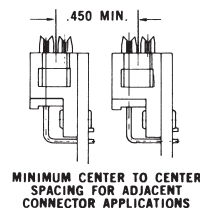
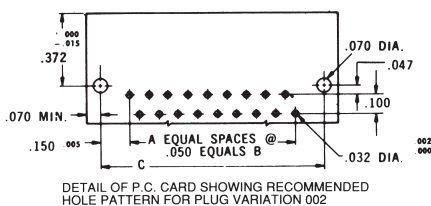
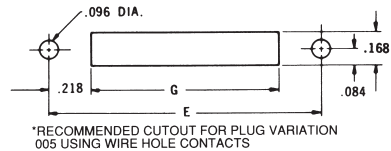
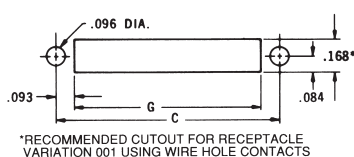
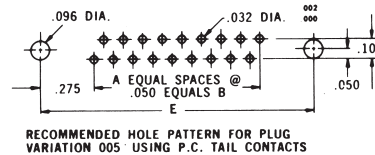
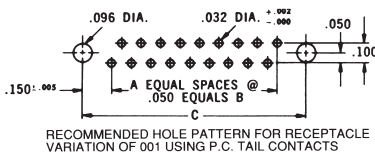

*When used in metal panel with Code Contact 722 cut out diam. Is .210".

Series 8223 – 0.100" Dual Row Square Grid

FEATURES

- Wide range of contact terminations including wire wrapping, P.C. solder tail, wire hole, wire crimp
- For 1/16", 3/32" P.C. card
- Polarity and keying are built into the connector body to prevent mismatching
- Perpendicular or parallel connector mounting
- Proven Varicon® contact reliability
- Protected male; recessed female contacts

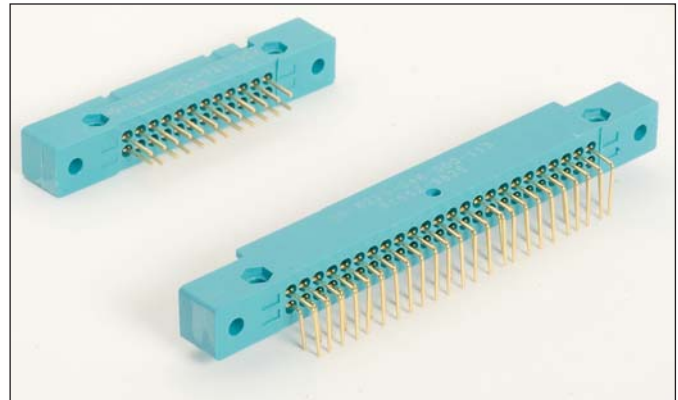

TECHNICAL SPECIFICATIONS CONTACTS

Current Rating:
5 amperes with 22 AWG wire

Contact Resistance:
6 milliohms, maximum

Contact Material and Plating:
Phosphor Bronze
Nickel plate, 50 to 100 micro-inches, followed by gold plate.
10 microinches minimum

INSULATORS

Material:
Diallyl Phthalate, glass-filled, flame resistant, per MIL-M-14-F, Type SDGF

Insulation Resistance:
5,000 megohms, minimum

Dielectric Withstanding Voltage:
Sea Level: 1,000 Volts rms

Insertion/Withdrawal Force:
2 to 8 ounces per contact

ORDERING CODE

00

8223

024

000

001

Number of Contacts
024, 048, 072 & 096

Contact Code

Variation Code

Use three digit code number when contacts are to be factory installed. If contacts are to be supplied loose, or contact tails to be formed, use three zeros (000) in contact code section. Note that the wire crimp tail contacts can only be ordered as separate items by part numbers.

Code	Profile	Description	Part No.	H Dim.	Board Thk.	Fig.
000		Coined Tail Formed 90° after installing (Max. 0236 Diag.)	60 8223 0223 60 8223 0213	.080	.062	1
000		Coined Tail Formed 90° after installing (Max. 0236 Diag.)	60 8223 0243 60 8223 0253	.093		1
722		Wire Hole Tail (.032 x .050)	60 8200 1613	.162		3
721		P.C. Tail .020 Sq.	60 8200 1623	.228		4
736		P.C. Tail .020 Sq.	60 8200 1633	.259		4
737		P.C. Tail .020 Sq.	60 8200 1643	.541		4
753		P.C. Tail .020 Sq.	60 8200 1653	.103		4
771		P.C. Tail .020 Sq.	60 8200 1663	.462		4
000		Crimp Contact (Reel 3000) 22-30 AWG	60 8216 0323			5
000		Crimp Contact (Loose) 22-30 AWG	60 8216 0313			5
491		Wrappable/Removable Contact (.025 Sq.)	60 8216 0413	.560		6

Insulator Type	Variation	Contact Style	Cover	Bracket	Accessories			Refer To Figure	Board Thickness
					Guide Pins Sockets (R)				
					Keying	Threaded Locking	Lkg. Kyg.		
Male (Exposed Contacts)	001	Formed Contact Terminal			X			1	.080 2.03 .062 1.57
	002	PC Terminal			X			2	
		Wire Hole Terminal			X			3	
		PC Straight Terminal			X			4	
		Crimp Contact			X			5	
003	Wrappable Removable			X			6		
Female (Exposed Contacts)	004	Formed Contact Terminal			X			1	.093 2.36
	901	Formed Contact Terminal			X			1	.080 2.03 .062 1.57
		PC Terminal			X			2	
		Wire Hole Terminal			X			3	
		PC Straight Terminal			X			4	
	902	Crimp Contact			X			5	
	903	Wrappable Removable			X			6	
	904	Formed Contact Terminal			X			1	.093 2.36

Series 8223 – 0.100" Dual Row Square Grid

MALE INSULATORS

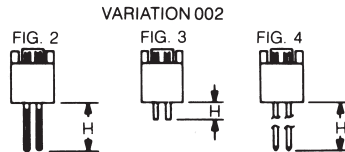
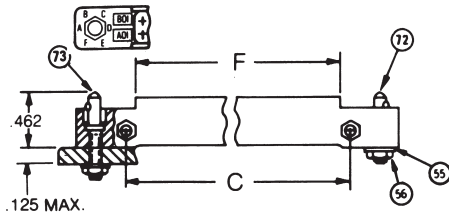
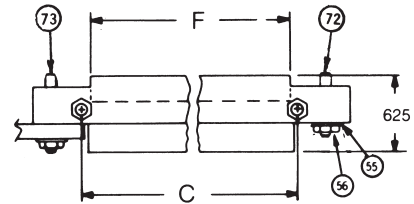
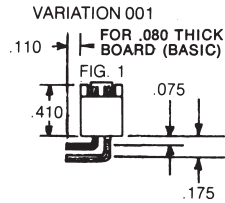
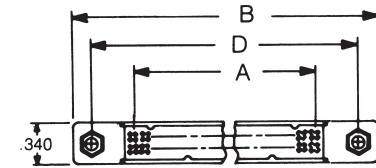

CRIMP TYPE

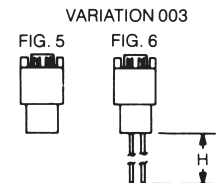

FEMALE INSULATORS

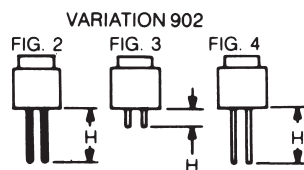
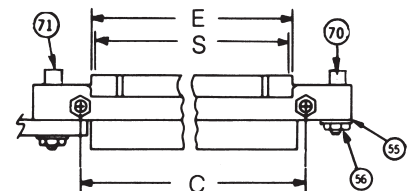
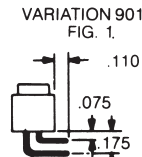
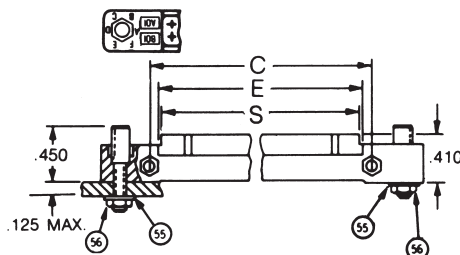

CRIMP TYPE

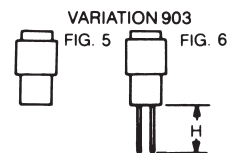

MOUNTING LAYOUT

Panel for Figures 2, 3, & 4

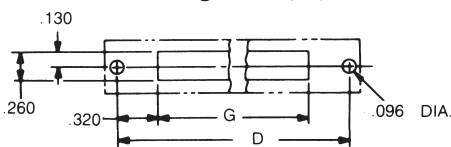

Panel for Figures 5 & 6

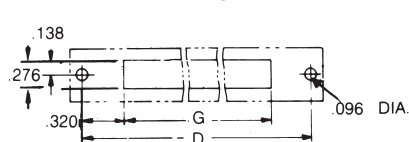

P.C. Board for Figure 1

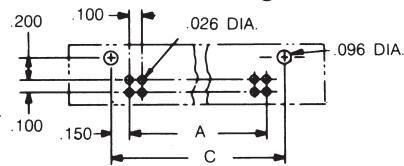

P.C. Board for Figures 2, 3, & 4

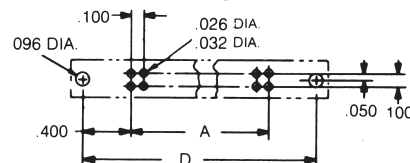

MOUNTING HARDWARE

(See drawings for correct assembly of hardware. Hardware shown is supplied with each board mounted connector.)

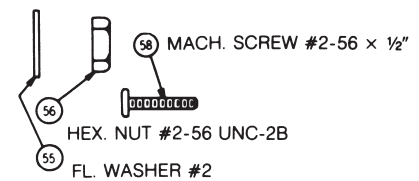

KEY TO DIAGRAMS

No. of Contacts	A	B	C	D	E	F	G	H	S
24	1.1	2.2	1.4	1.9	1.27	1.252	1.26	Pg. 26	1.236
48	2.3	3.4	2.6	3.1	2.47	2.452	2.46	Pg. 26	2.436
72	3.5	4.6	3.8	4.3	3.67	3.652	3.66	Pg. 26	3.636
96	4.7	5.8	5.0	5.5	4.87	4.852	4.86	Pg. 26	4.836

Item	Size	Part # Unified Thread
55	#2	90-0502-0031-11-053
56	#2-5	90-0602-0121-11-053
58	#2-5	90-0902-0136-11-053

Item	Size	Part #
70	#2-5	60-8223-4562-11-062
71	#2-5	60-8223-4522-11-062
72	#2-5	60-8223-4662-11-062
73	#2-5	60-8223-4662-11-062

Contact Strip

FEATURES

- Contacts supplied imbedded in vinyl strips, correctly spaced and ready for insertion and staking into p.c. card
- For 1/16" thick p.c. cards
- Mates with Series 7000 Receptacles

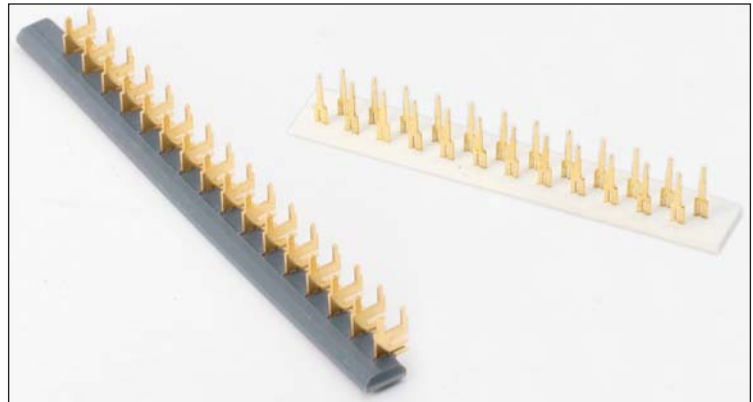

TECHNICAL SPECIFICATIONS

Current Rating:
10 amperes

Contact Resistance:
6 milliohms, maximum

Contact Material and Plating:
Phosphor Bronze per QQ-B-750, Composition A.

†Gold, 10 microinches minimum, over nickel, 30 to 100 microinches

Insertion/Withdrawal Force:
2 to 16 ounces per contact

ORDERING CODE

02
Contacts on Plastic Strips

000
Number of Contacts on Strip
.100 ? = 120 max
.125 ? = 90 max
.150 ? = 80 max
.200 ? = 60 max

147
Type of Contact

5
Contact Pattern
How the contacts are set on the plastic

200
Contact Spacing
100 = .100
125 = .125
150 = .150
200 = .200

000
Variation
Plating
Marking
Other

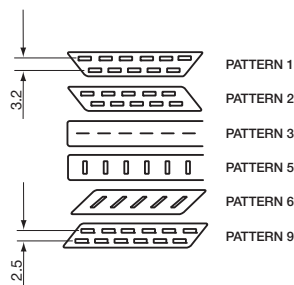

Contact Strip

Contact Code	Loose Contact Part Number	For Card Thickness	Silhouette	Available Pattern	Application	Fig #
013	60 5001 1913 00 339	1/16" (0.0625)			Module Card Contact	
014	60 5001 1923 00 339	3/32" (0.09375)			Module Card Contact	
135	60 7001 0413 00 339	1/16" (0.0625)			Lower Tier w/Wire Hole	
137	60 7001 0513 00 339	1/16" (0.0625)			Upper Tier w/Wire Hole	
147	60 7001 1513 00 339	1/16" (0.0625)			Lower Tier	
323	60 8240 0213 00 339	1/16" (0.0625)			Base Card Contact	5, 6
327	60 8240 0243 00 339	3/32" (0.09375)			Base Card Contact	5, 6
332	60 8240 0313 00 339	1/16" (0.0625)			Module Card Contact	

Varicon® Contact Strip Perpendicular Cards – Pad Spacing .200"

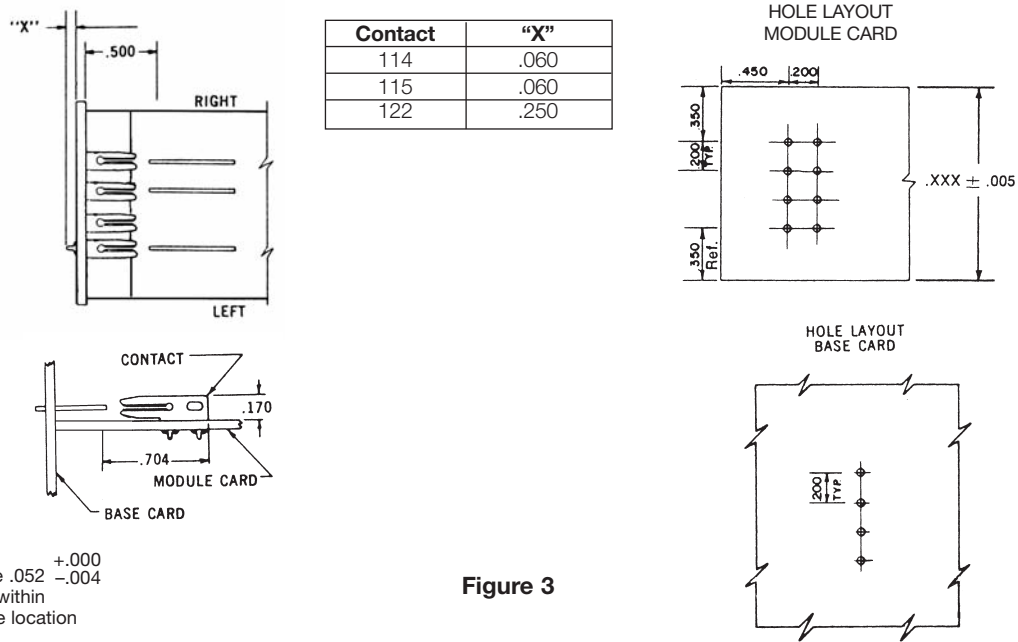

Figure 3

Tandem Cards – Pad Spacings .125"/.150"/.200"

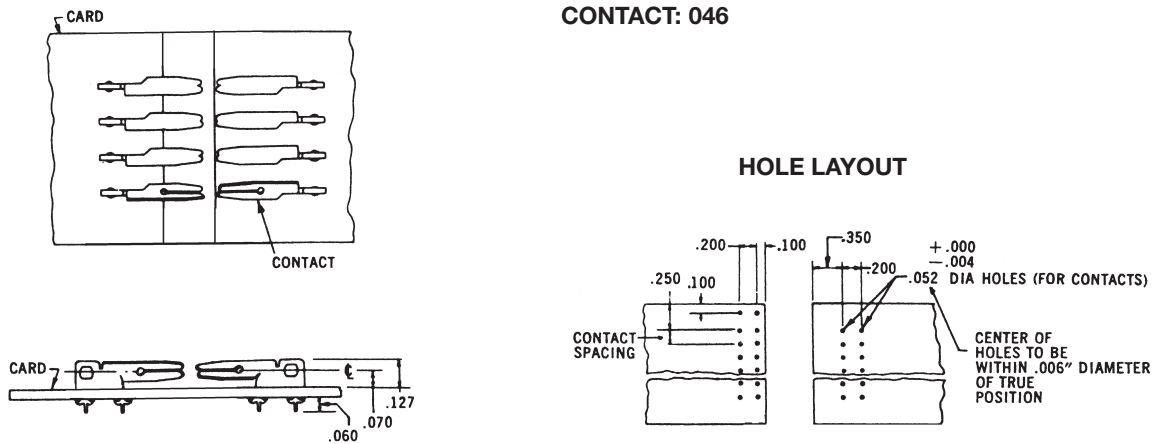

Figure 4

TECHNICAL SPECIFICATIONS

Contacts:

Contacts on .125", .150" or .200" Centers
Contacts supplied on disposable plastic
carrier strips.

- .200" spacing with a max. of 60 contacts.
- .150" spacing with a max. of 80 contacts.
- .125" spacing with a max. of 90 contacts.

Contact Resistance:

0.006 Ohm, maximum

Contact Material and Plating:

Phosphor Bronze

Gold, 50 microinches minimum,
over nickel, 50 to 100 microinches

Insertion/Withdrawal Force:

2 to 16 ounces per contact

Current Rating:

8 amperes



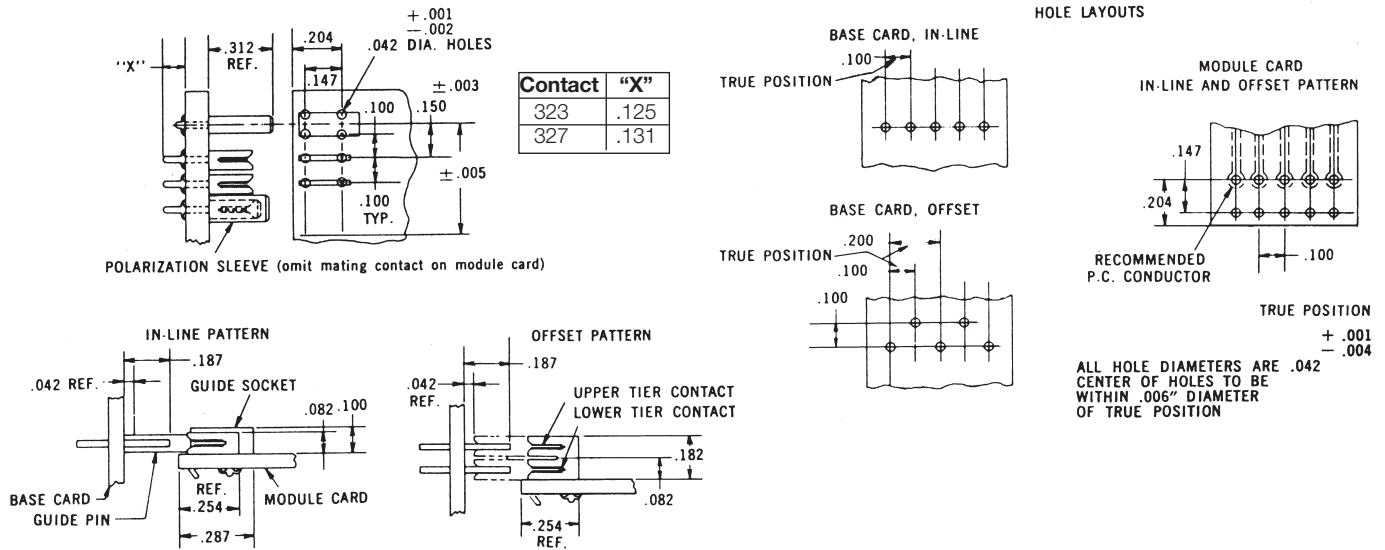

Figure 5

TECHNICAL SPECIFICATIONS

Contacts:

Supplied on disposable plastic carrier strips

Current Rating:

5 amperes

Contact Resistance:

0.006 Ohm, maximum

Contact Material and Plating:

Phosphor Bronze

†Gold, 50 microinches minimum,
over nickel, 50 to 100 microinches

Insertion/Withdrawal Force:

2 to 16 ounces per contact

Parallel Cards – .213" Between Cards

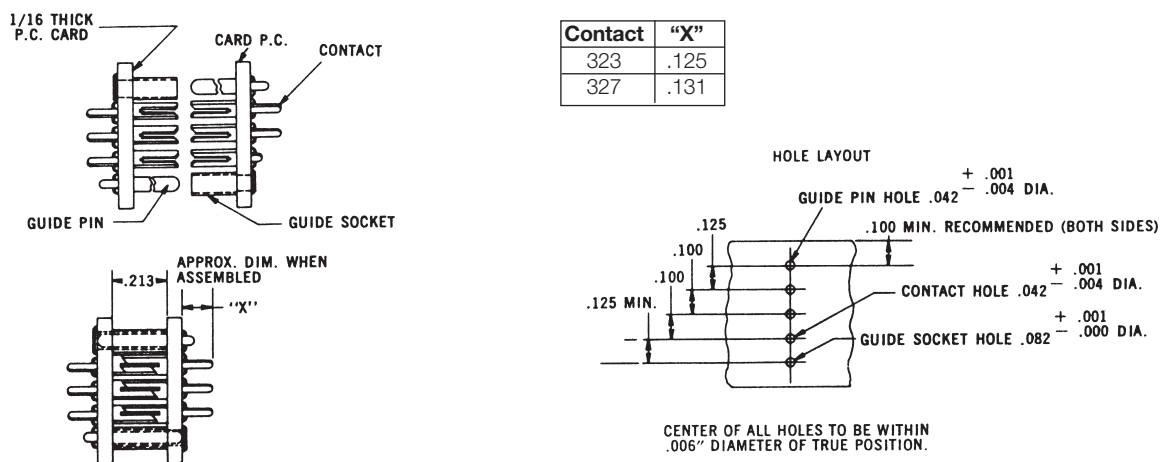
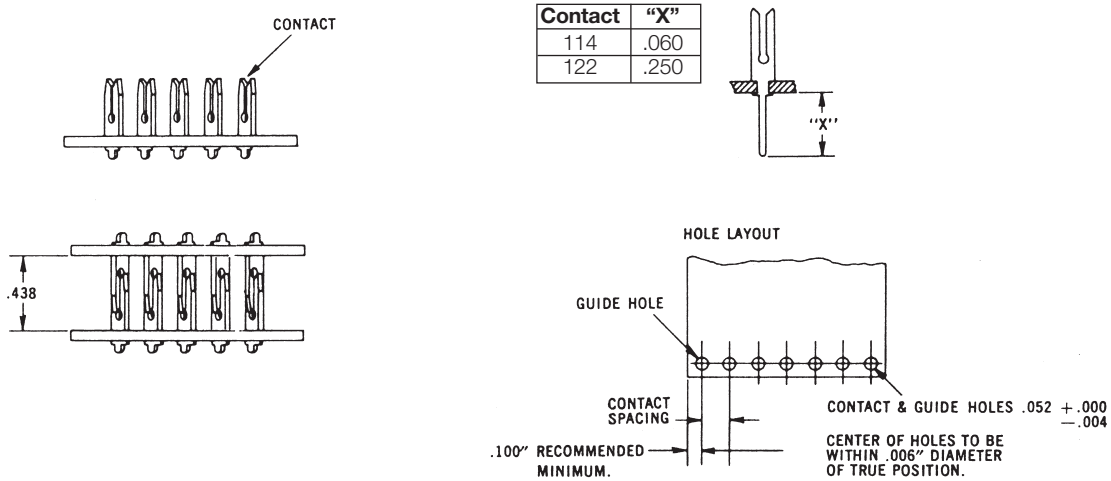

Figure 6

Varicon® Contact Strip – Technical Parallel Cards – .438" Between Cards



Contact	"X"
114	.060
122	.250

Figure 1

TECHNICAL SPECIFICATIONS

Contacts:
Supplied on disposable plastic carrier strips

Current Rating:
8 amperes

Contact Resistance:
0.006 Ohm, maximum

Contact Material and Plating:
Phosphor Bronze
Gold, 50 microinches minimum,
over nickel, 50 to 100 microinches

Insertion/Withdrawal Force:
2 to 16 ounces per contact

- Contacts – Contacts are available on four spacings; each spacing has a corresponding maximum number of contacts. Fewer contacts can be ordered.
 - .200" spacing with a max. of 60 contacts per strip
 - .150" spacing with a max. of 80 contacts per strip
 - .125" spacing with a max. of 90 contacts per strip

Perpendicular Cards – Pad Spacing .100"

FEATURES

- For 1/16" and 3/32" thick p.c. cards
- Contacts supplied imbedded in vinyl strips, correctly spaced and ready for insertion and staking into p.c. card
- Complete set of plug contacts supplied on two disposable plastic strips, one for upper-tier contacts, the other for lower-tier contacts
- Efficient and economical installation equipment includes staking and strip removal tools for all applications

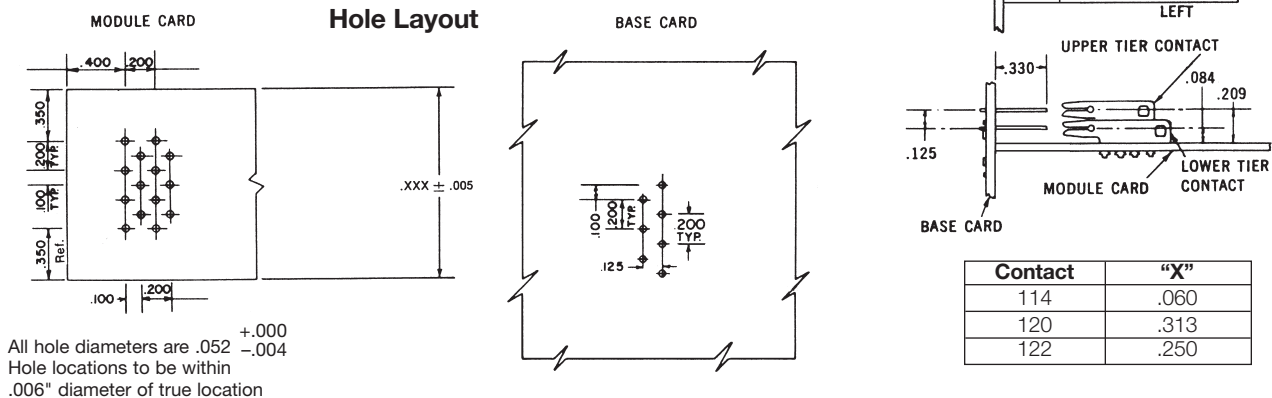

Contact	"X"
114	.060
120	.313
122	.250

Figure 2



Connector Short Form

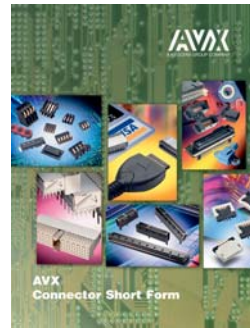

DIN41612 / EN60603-2 Connectors



FFC/FPC Connectors



Memory Card Components

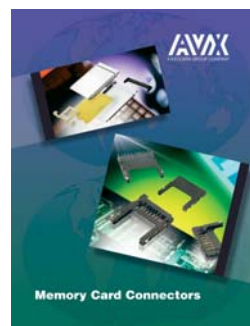

PASSIVES

Capacitors

- Multilayer Ceramic
- Tantalum
- Microwave
- Glass
- Film
- Power Film
- Power Ceramic
- Ceramic Disc
- Trimmer
- BestCap™

Resistors

- Arrays

Timing Devices

- Resonators
- Oscillators
- Crystals

Filters

- EMI
- SAW
- Dielectric

Thin Film

- Inductors
- Fuses
- Capacitors
- Couplers
- Baluns
- Filters

Integrated Passive Components

- Low Inductance Chip Arrays
- Capacitor Arrays
- Dual Resonance Chips
- Custom IPCs

Voltage Suppressors, Varistors and Thermistors

Acoustical Piezos

CONNECTORS

- 2mm Hard-Metric for CompactPCI®

- Automotive Connectors

- Board to Board Connectors – SMT and Through-Hole

- Card Edge

- Compression

- Custom Designed Connectors

- Customized Backpanel, Racking and Harnessing Services

- DIN 41612 Connectors

- FFC/FPC Connectors

- Insulation Displacement Connectors

- I/O Connectors

- Memory Card Connectors
CF, PCMCIA, SD, MMC

- MOBO™, I/O, Board to Board and Battery Connectors

- Press-fit Connectors

- Varicon®

- Wire to Board, Crimp or IDC

**For more information please visit
our website at**

<http://www.avx.com>

NOTICE: Specifications are subject to change without notice. Contact your nearest AVX Sales Office for the latest specifications. All statements, information and data given herein are believed to be accurate and reliable, but are presented without guarantee, warranty, or responsibility of any kind, expressed or implied. Statements or suggestions concerning possible use of our products are made without representation or warranty that any such use is free of patent infringement and are not recommendations to infringe any patent. The user should not assume that all safety measures are indicated or that other measures may not be required. Specifications are typical and may not apply to all applications.

© AVX Corporation

AMERICAS

AVX Greenville, SC
Tel: 864-967-2150

AVX Northwest, WA
Tel: 360-699-8746

AVX Midwest, IN
Tel: 317-861-9184

AVX Mid/Pacific, CA
Tel: 408-988-4900

AVX Northeast, MA
Tel: 617-479-0345

AVX Southwest, CA
Tel: 949-859-9509

AVX Canada
Tel: 905-238-3151

AVX South America
Tel: +55-11-4688-1960

EUROPE

AVX Limited, England
Tel: +44-1276-697000

AVX S.A.S., France
Tel: +33-1-69-18-46-00

AVX GmbH, Germany
Tel: +49-0811-95949-0

AVX SRL, Italy
Tel: +39-02-614-571

AVX Czech Republic
Tel: +420-57-57-57-521

AVX/ELCO UK
Tel: +44-1638-675000

ELCO Europe GmbH
Tel: +49-2741-299-0

AVX S.A., Spain
Tel: +34-91-63-97-197

AVX Benelux
Tel: +31-187-489-337

ASIA-PACIFIC

**AVX/Kyocera (S) Pte Ltd.,
Singapore**
Tel: +65-6286-7555

**AVX/Kyocera, Asia, Ltd.,
Hong Kong**
Tel: +852-2363-3303

**AVX/Kyocera Yuhan Hoesa,
South Korea**
Tel: +82-2785-6504

**AVX/Kyocera HK Ltd.,
Taiwan**
Tel: +886-2-2656-0258

**AVX/Kyocera (M) Sdn Bhd,
Malaysia**
Tel: +60-4228-1190

**AVX/Kyocera International
Trading Co. Ltd.,
Shanghai**
Tel: +86-21-3255 1933

**AVX/Kyocera Asia Ltd.,
Shenzen**
Tel: +86-755-3336-0615

**AVX/Kyocera International
Trading Co. Ltd.,
Beijing**
Tel: +86-10-6588-3528

**AVX/Kyocera India
Liaison Office**
Tel: +91-80-6450-0715

ASIA-KED (KYOCERA Electronic Devices)

KED Hong Kong Ltd.
Tel: +852-2305-1080/1223

**KED Hong Kong Ltd.
Shenzen**
Tel: +86-755-3398-9600

**KED Company Ltd.
Shanghai**
Tel: +86-21-3255-1833

**KED Hong Kong Ltd.
Beijing**
Tel: +86-10-5869-4655

KED Taiwan Ltd.
Tel: +886-2-2950-0268

**KED Korea Yuhan Hoesa,
South Korea**
Tel: +82-2-783-3604/6126

**KED (S) Pte Ltd.
Singapore**
Tel: +65-6509-0328

**Kyocera Corporation
Japan**
Tel: +81-75-604-3449

Contact:



Mouser Electronics

Authorized Distributor

Click to View Pricing, Inventory, Delivery & Lifecycle Information:

AVX:

[008016020000608](#) [008016038000601](#) [008016038000608](#) [008016056000608](#) [008016120000608](#)
[008016120000001](#) [008016120000007](#) [008016120000008](#) [008016038000002](#) [008016038000008](#) [008016020000007](#)
[008016020000001](#) [008016090000002](#) [008016090000008](#) [008016090000001](#) [008016056000001](#)
[608017032300339](#) [608216031300343](#) [608017031300339](#) [008223096491101](#) [608218471500152](#) [008026075000715](#)
[008219018000112](#) [061877040000000](#) [067852010000000](#) [008223024721107](#) [008219018753111](#)
[008223048722009M](#) [008016056000610](#) [008016056000604](#) [008218054000002](#) [008129006610001](#)
[608223466200062](#) [608017000000000](#) [020140135200000](#) [020243279200100](#) [067698010000000](#)
[208014264000100S](#) [608216000000000](#)