

THIS DRAWING IS UNPUBLISHED. RELEASED FOR PUBLICATION
 © COPYRIGHT - By - ALL RIGHTS RESERVED.

REVISIONS				
P	LTR	DESCRIPTION	DATE	APVD
D1		REVISED PER ECR-16-010647	08OCT16	O.C D.Z

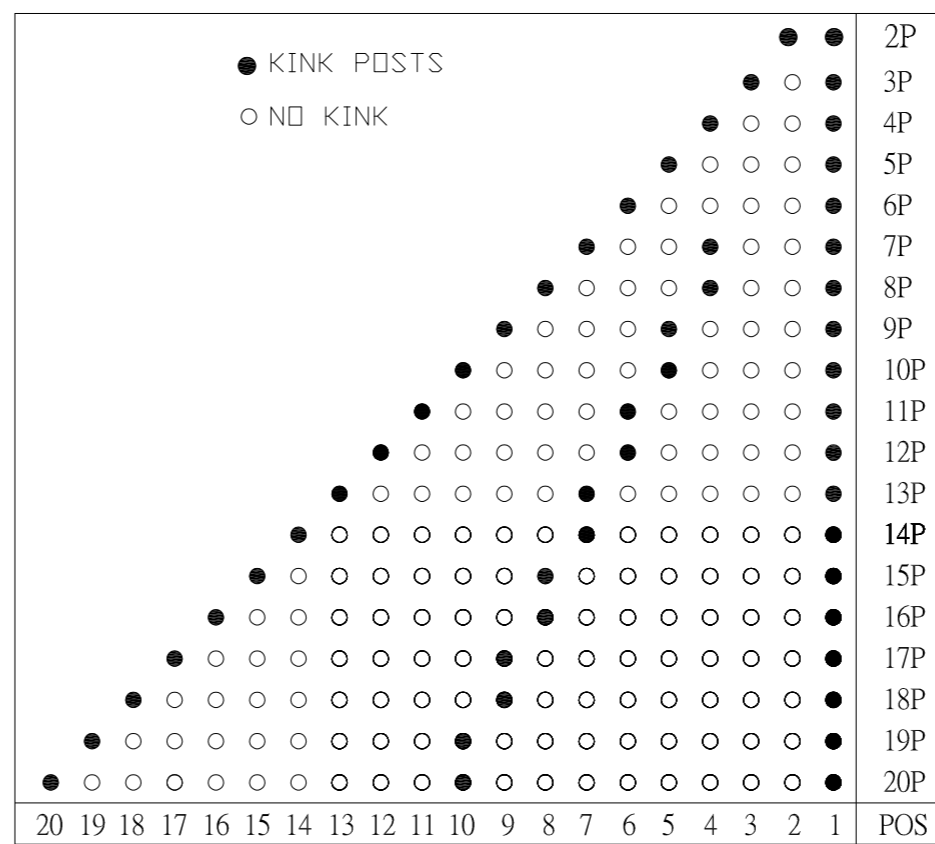
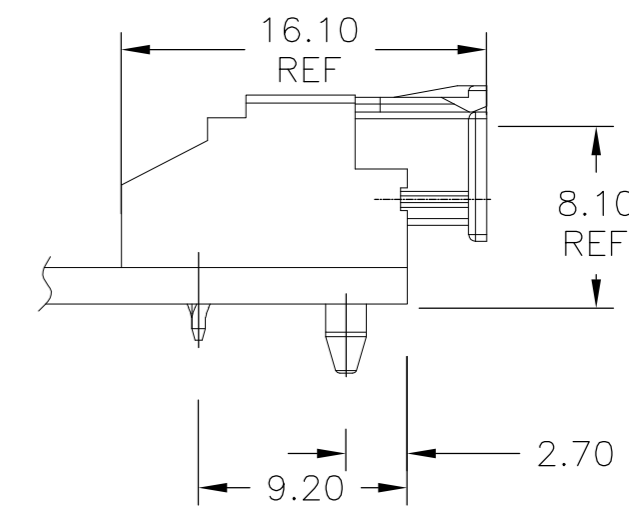
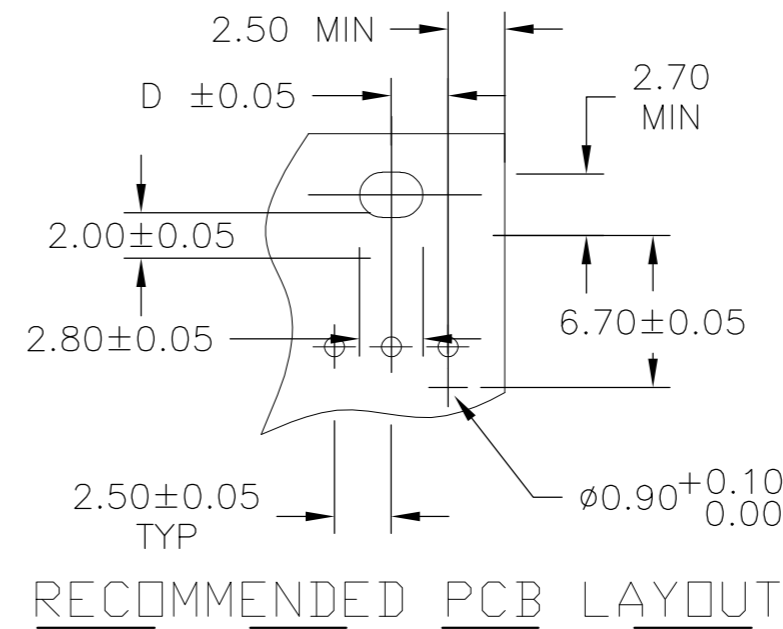
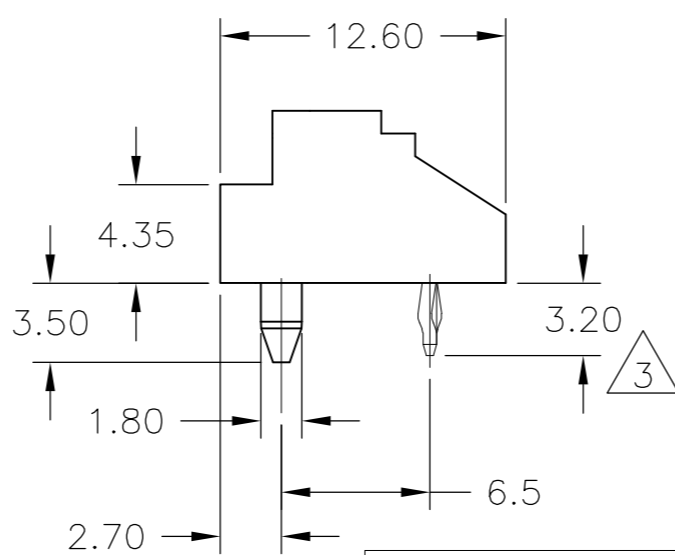
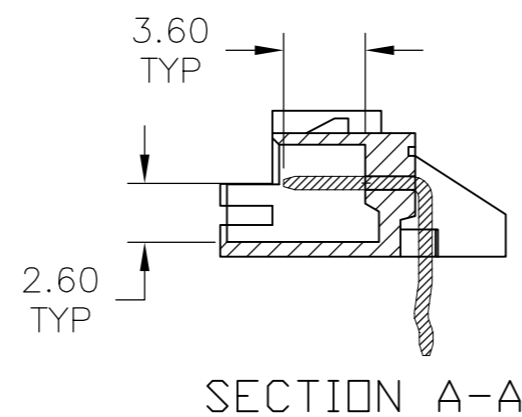
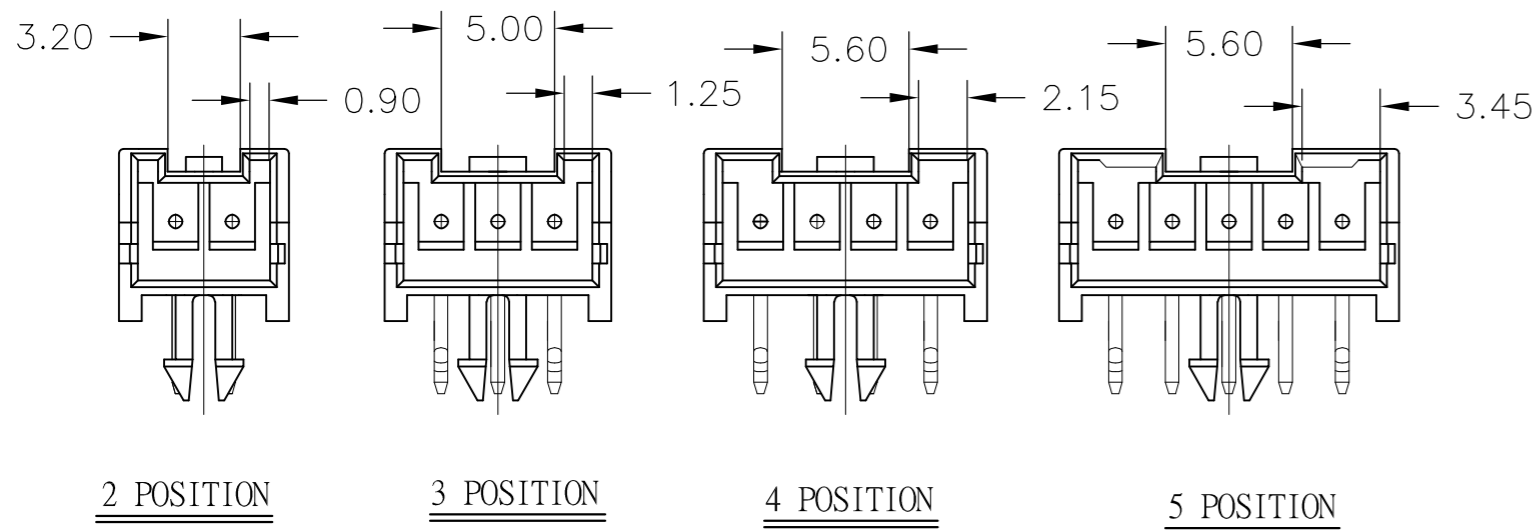
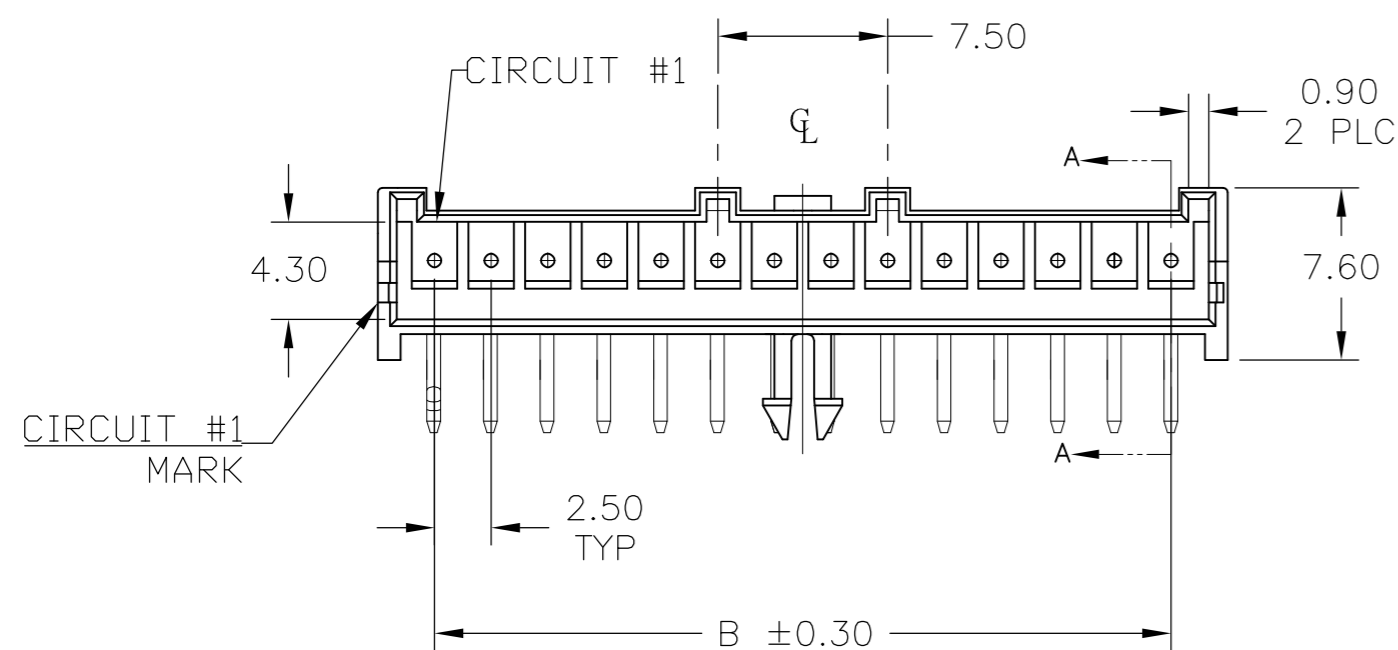
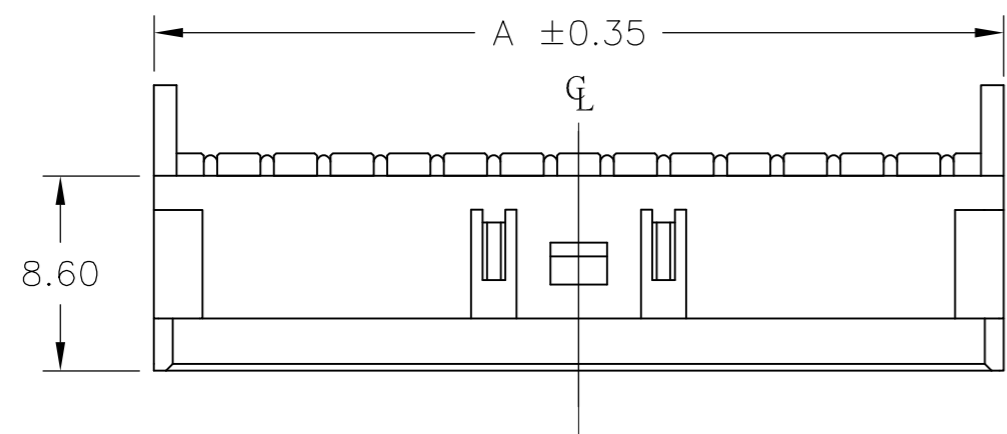
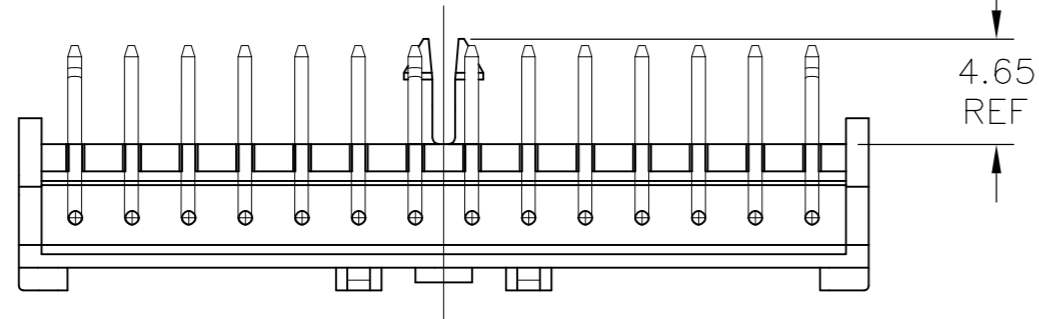

- 1 MATERIAL,
HOUSING: NYLON 94VO, WHITE.
CONTACT: COPPER ALLOY
- 2 FINISH: CONTACT: BRIGHT TIN OVER
NICKEL UNDERPLATED OVER ALL
- 3 CONTACT SOLDER TAIL KINK DIRECTION
(BOARDLOCK). OUTER POSITIONS KINK FRONT,
INSIDE POSITION KINK BACK.

31.25	47.50	52.50	20	2-1744426-0
28.75	45.00	50.00	19	1-1744426-9
26.25	42.50	47.50	18	1-1744426-8
23.75	40.00	45.00	17	1-1744426-7
21.25	37.50	42.50	16	1-1744426-6
18.75	35.00	40.00	15	1-1744426-5
16.25	32.50	37.50	14	1-1744426-4
15.00	30.00	35.00	13	1-1744426-3
13.75	27.50	32.50	12	1-1744426-2
12.50	25.00	30.00	11	1-1744426-1
11.25	22.50	27.50	10	1-1744426-0
10.00	20.00	25.00	9	1744426-9
8.75	17.50	22.50	8	1744426-8
7.50	15.00	20.00	7	1744426-7
6.25	12.50	17.50	6	1744426-6
5.00	10.00	15.00	5	1744426-5
3.75	7.50	12.50	4	1744426-4
2.50	5.00	10.00	3	1744426-3
1.25	2.50	7.50	2	1744426-2
DIM C	DIM B	DIM A	POS	PART NO.

THIS DRAWING IS A CONTROLLED DOCUMENT.

DWN	JR RUTH	09JAN2012
CHK	SAM MACE	09JAN12
APVD	SAM MACE	09JAN12
PRODUCT SPEC	108-2418	
APPLICATION SPEC	114-13315	
WEIGHT	0	
CUSTOMER DRAWING		

TE Connectivity

NAME: -
 HEADER HOUSING ASSEMBLY, EP 2.5 RIGHT ANGLE

SIZE	CAGE CODE	DRAWING NO	RESTRICTED TO
A2	00779	C=1744426	-

SCALE: N/A SHEET: 1 OF 1 REV: D1

Mouser Electronics

Authorized Distributor

Click to View Pricing, Inventory, Delivery & Lifecycle Information:

[TE Connectivity:](#)

[1744426-6](#)