

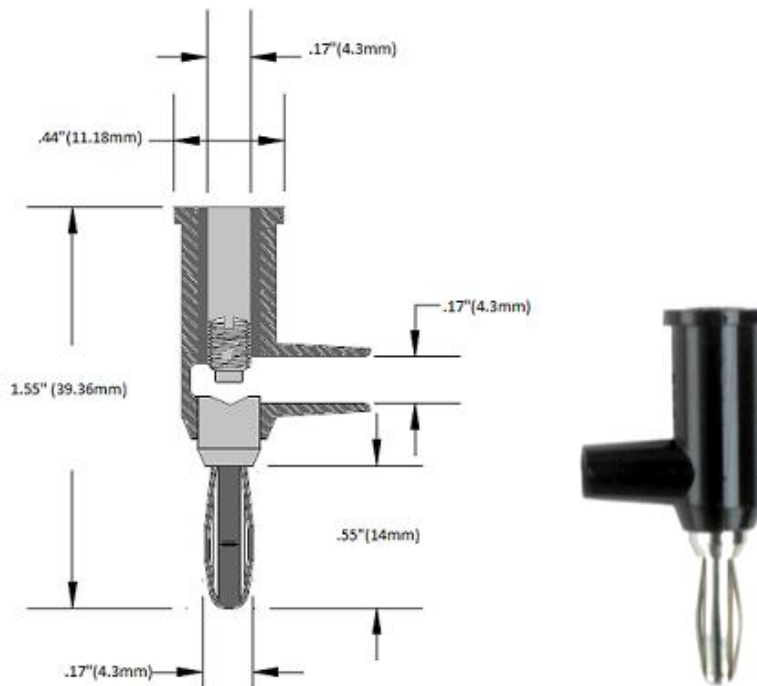

BU-P1825-*
(SOLDERLESS STACKABLE BANANA PLUG)



DESCRIPTION:

- Solderless, stackable, standard 4mm banana plug designed for various applications.
- For all types of wire 22 to 18 AWG. with insulation OD's less than .17" (4 mm)
- Easily field serviceable.
- Wire enters through side hole and is secured with setscrew.

MATERIALS:

Banana Plug: Nickel Plated Beryllium Copper
Insulation: Polypropylene

RATINGS:

15 AMPS
Hand free testing to 5000 VRMS
Max Temp: +122°F (50°C)

STANDARD COLORS: BU-P1825- * {* indicates color: -0 BLACK; -2 RED}

Mouser Electronics

Authorized Distributor

Click to View Pricing, Inventory, Delivery & Lifecycle Information:

[Mueller Electric:](#)

[BU-P1825-0](#)