

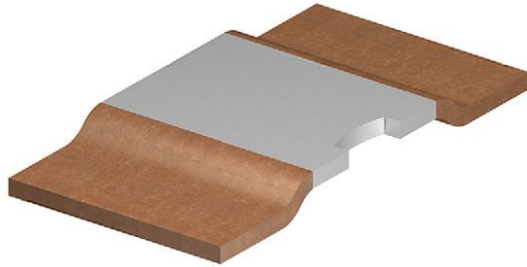

Power Metal Strip® Resistors, High Temperature (275 °C), Low Value (down to 0.0002 Ω), Surface Mount



FEATURES

- Ideal for all types of current sensing, voltage division and pulse applications including switching and linear power supplies, instruments, power amplifiers
- Proprietary processing technique produces extremely low resistance values, down to 0.0002 Ω
- Specially selected and stabilized materials allow for high temperature derating (to +275 °C)
- Sulfur resistance by construction that is unaffected by high sulfur environments
- All welded construction
- Solid metal iron-chrome or manganese-copper alloy resistive element with low TCR (< 20 ppm/°C)
- Very low inductance (< 5 nH)
- Low thermal EMF (< 3 μV/°C)
- AEC-Q200 qualified available ⁽¹⁾
- Material categorization: for definitions of compliance please see www.vishay.com/doc?99912



DESIGN SUPPORT TOOLS AVAILABLE



Note

⁽¹⁾ Flame retardance test may not be applicable to some resistor technologies

STANDARD ELECTRICAL SPECIFICATIONS						
GLOBAL MODEL	SIZE	POWER RATING <i>P</i> _{70 °C} W	TOLERANCE %	RESISTANCE VALUE RANGE Ω	RESISTANCE VALUES CURRENTLY AVAILABLE ⁽¹⁾ Ω	WEIGHT (typical) g/1000 pieces
WSLT3921	3921	3.0	1.0, 5.0	0.2m to 4m	0.2m, 0.3m, 0.5m, 0.7m, 1m, 1.5m, 2m, 2.5m, 3m, 4m	281
WSLT5931	5931	5.0	1.0, 5.0	0.3m to 3m	0.1m, 0.2m, 0.3m, 0.5m, 1m, 2m, 3m	398

Note

⁽¹⁾ Other values may be available, contact factory

GLOBAL PART NUMBER INFORMATION																	
Global Part Numbering: WSLT39212L000FEA (WSLT3921, 0.002 Ω, ± 1 %) (visit www.vishay.net Vishay Dale parts numbering manual for all options)																	
W	S	L	T	3	9	2	1	2	L	0	0	0	F	E	A		
GLOBAL MODEL (7 digits)			RESISTANCE VALUE ⁽¹⁾ (5 digits)			TOLERANCE CODE (1 digit)		PACKAGING CODE ⁽²⁾ (2 digits)				SPECIAL ⁽³⁾ (up to 2 digits)					
WSLT3921 WSLT5931			L = mΩ 2L000 = 0.002 Ω			F = ± 1.0 % J = ± 5.0 %		EA = lead (Pb)-free, tape/reel EK = lead (Pb)-free, bulk				Reserved for future specials					

Notes

- ⁽¹⁾ WSL Marking (www.vishay.com/doc?30327)
- ⁽²⁾ Packaging code: EB (lead (Pb)-free) and TB (tin / lead) are non-standard packaging codes designating 1000 piece reels. These non-standard packaging codes are identical to our standard EA (lead (Pb)-free) and TA (tin / lead), except that they have a package quantity of 1000 pieces
- ⁽³⁾ Follow link for customization capabilities: www.vishay.com/doc?48163

TECHNICAL SPECIFICATIONS		
PARAMETER	UNIT	RESISTOR CHARACTERISTICS
Component temperature coefficient (including terminal) ⁽¹⁾ TCR measured from -55 °C to 150 °C	ppm/°C	± 175 for 0.2 mΩ to < 1 mΩ
		± 75 for 1 mΩ to 4 mΩ
Element TCR ⁽²⁾	ppm/°C	< 20
Operating temperature range	°C	-65 to +275
Maximum working voltage ⁽³⁾	V	$(P \times R)^{1/2}$

Notes

- (1) Component TCR - total TCR that includes the TCR effects of the resistor element and the copper terminal
- (2) Element TCR - only applies to the alloy used for the resistor element; refer to item 1 in the construction illustration on the following page
- (3) Maximum working voltage - the WSL is not voltage sensitive, but is limited by power / energy dissipation and is also not ESD sensitive

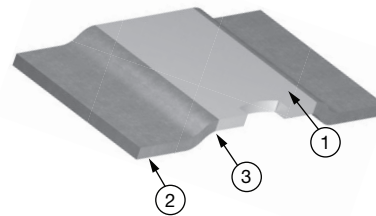
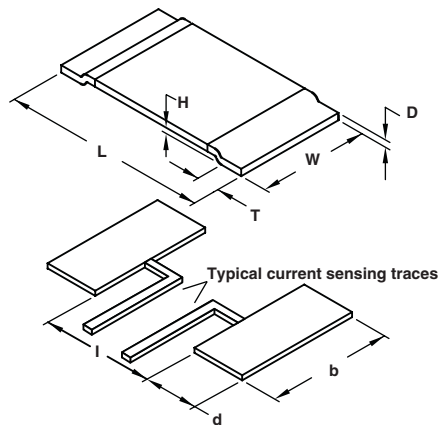
DIMENSIONS

- 1) Resistive element: Fe-Cr (element material used is dependent on resistance value)
- 2) Terminal: Solid copper
- 3) Terminal / element weld

Notes

- 3D models available: 3921 model www.vishay.com/doc?30315; 5931 model www.vishay.com/doc?30317
- Surface mount solder profile recommendations: www.vishay.com/doc?31052

MODEL	DIMENSIONS in inches (millimeters)			
	L	W	H	T
WSLT3921	0.394 ± 0.010 (10.0 ± 0.254)	0.205 ± 0.010 (5.20 ± 0.254)	0.020 (0.5)	0.080 ± 0.010 (2.00 ± 0.254)
WSLT5931	0.591 ± 0.010 (15.0 ± 0.254)	0.305 ± 0.010 (7.75 ± 0.254)	0.020 (0.5)	0.157 ± 0.010 (4.00 ± 0.254)

MODEL	SOLDER PAD DIMENSIONS in inches (millimeters)		
	d	b	I
WSLT3921	0.106 ± 0.010 (2.70 ± 0.254)	0.244 ± 0.010 (6.20 ± 0.254)	0.220 ± 0.005 (5.60 ± 0.13)
WSLT5931	0.205 ± 0.010 (5.20 ± 0.254)	0.344 ± 0.010 (8.75 ± 0.254)	0.220 ± 0.005 (5.60 ± 0.13)

GLOBAL MODEL	RESISTANCE VALUE (mΩ)	TYPICAL THERMAL RESISTANCE (°C/W)	"D" THICKNESS (Inches)	ELEMENT MATERIAL
WSLT3921	0.2	2.7	0.0560	Mn-Cu
WSLT3921	0.5	5.8	0.0300	Mn-Cu
WSLT3921	0.7	6.3	0.0205	Mn-Cu
WSLT3921	1.0	10.9	0.0150	Mn-Cu
WSLT3921	2.0	12.0	0.0270	Fe-Cr
WSLT3921	3.0	20.7	0.0170	Fe-Cr
WSLT3921	4.0	22.8	0.0130	Fe-Cr
WSLT5931	0.3	3.5	0.0300	Mn-Cu
WSLT5931	0.5	5.7	0.0180	Mn-Cu
WSLT5931	1.0	7.2	0.0330	Fe-Cr
WSLT5931	2.0	13.2	0.0155	Fe-Cr
WSLT5931	3.0	19.3	0.0105	Fe-Cr



DERATING - AMBIENT TEMPERATURE

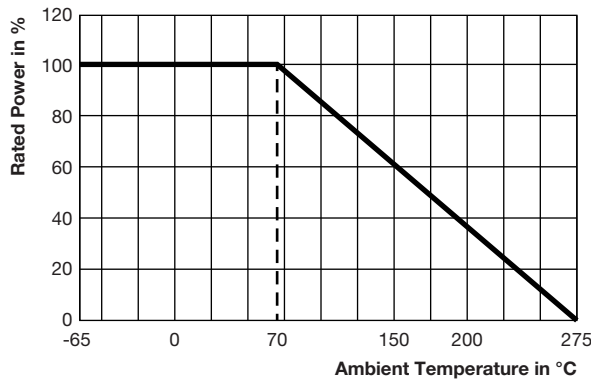

PULSE CAPABILITY

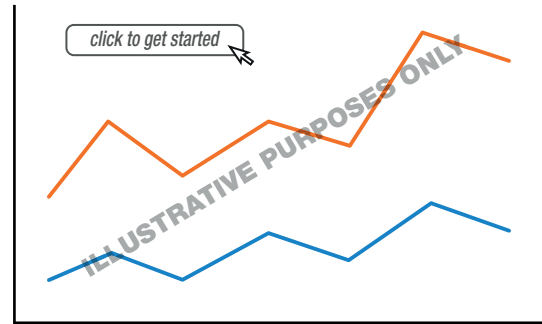

www.vishay.com/resistors/power-metal-strip-calculator

DERATING - TERMINAL TEMPERATURE

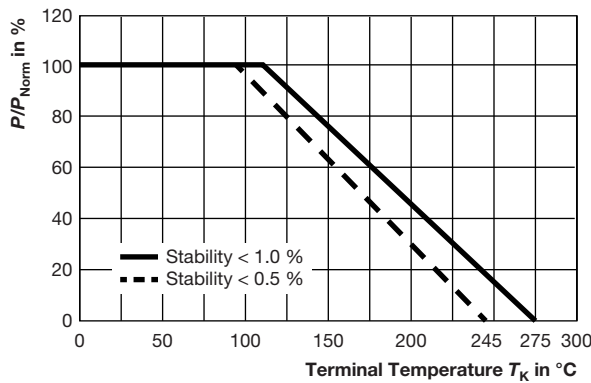

Example: WSLT3921 0.0005 Ω

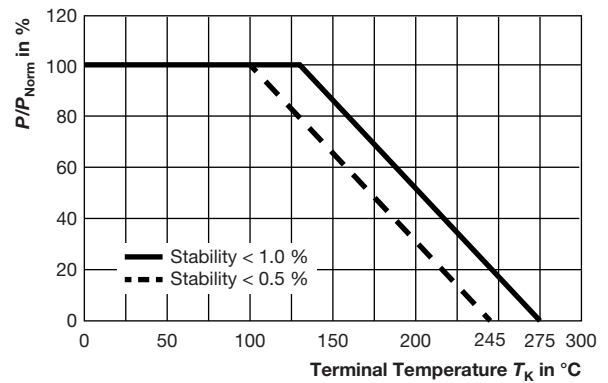

Example: WSLT5931 0.0005 Ω

PERFORMANCE		
TEST	CONDITIONS OF TEST	TEST LIMITS
Thermal shock	-55 °C to +150 °C, 1000 cycles, 15 min at each extreme	$\pm 1.0\% + 0.0005\ \Omega$
Short time overload	5x rated power for 5 s	$\pm 0.5\% + 0.0005\ \Omega$
Low temperature storage	-65 °C for 24 h	$\pm 0.5\% + 0.0005\ \Omega$
High temperature exposure	1000 h at +275 °C	$\pm 1.0\% + 0.0005\ \Omega$
Bias humidity	+85 °C, 85 % RH, 10 % bias, 1000 h	$\pm 0.5\% + 0.0005\ \Omega$
Mechanical shock	100 g's for 6 ms, 5 pulses	$\pm 0.5\% + 0.0005\ \Omega$
Vibration	Frequency varied 10 Hz to 2000 Hz in 1 min, 3 directions, 12 h	$\pm 0.5\% + 0.0005\ \Omega$
Load life	1000 h at +70 °C, 1.5 h "ON", 0.5 h "OFF"	$\pm 1.0\% + 0.0005\ \Omega$
Resistance to solder heat	3x at 250 °C $\pm 5\ \text{°C}$ for 30 s $\pm 5\ \text{s}$	$\pm 0.5\% + 0.0005\ \Omega$
Moisture resistance	MIL-STD-202, method 106, 0 % power, 7a and 7b not required	$\pm 0.5\% + 0.0005\ \Omega$

PACKAGING				
MODEL	REEL			
	TAPE WIDTH	DIAMETER	PIECES/REEL	CODE
WSLT3921	16 mm/embossed plastic	330 mm/13"	3000	EA
WSLT5931	24 mm/embossed plastic	330 mm/13"	1500	EA

Note

- Embossed carrier tape per EIA-481



Disclaimer

ALL PRODUCT, PRODUCT SPECIFICATIONS AND DATA ARE SUBJECT TO CHANGE WITHOUT NOTICE TO IMPROVE RELIABILITY, FUNCTION OR DESIGN OR OTHERWISE.

Vishay Intertechnology, Inc., its affiliates, agents, and employees, and all persons acting on its or their behalf (collectively, "Vishay"), disclaim any and all liability for any errors, inaccuracies or incompleteness contained in any datasheet or in any other disclosure relating to any product.

Vishay makes no warranty, representation or guarantee regarding the suitability of the products for any particular purpose or the continuing production of any product. To the maximum extent permitted by applicable law, Vishay disclaims (i) any and all liability arising out of the application or use of any product, (ii) any and all liability, including without limitation special, consequential or incidental damages, and (iii) any and all implied warranties, including warranties of fitness for particular purpose, non-infringement and merchantability.

Statements regarding the suitability of products for certain types of applications are based on Vishay's knowledge of typical requirements that are often placed on Vishay products in generic applications. Such statements are not binding statements about the suitability of products for a particular application. It is the customer's responsibility to validate that a particular product with the properties described in the product specification is suitable for use in a particular application. Parameters provided in datasheets and / or specifications may vary in different applications and performance may vary over time. All operating parameters, including typical parameters, must be validated for each customer application by the customer's technical experts. Product specifications do not expand or otherwise modify Vishay's terms and conditions of purchase, including but not limited to the warranty expressed therein.

Except as expressly indicated in writing, Vishay products are not designed for use in medical, life-saving, or life-sustaining applications or for any other application in which the failure of the Vishay product could result in personal injury or death. Customers using or selling Vishay products not expressly indicated for use in such applications do so at their own risk. Please contact authorized Vishay personnel to obtain written terms and conditions regarding products designed for such applications.

No license, express or implied, by estoppel or otherwise, to any intellectual property rights is granted by this document or by any conduct of Vishay. Product names and markings noted herein may be trademarks of their respective owners.