



The Infinite Bandwidth Company™

MIC5212

Dual 500mA LDO Regulator

Final

General Description

The MIC5212 is a dual linear voltage regulator with very-low dropout voltage (typically 10mV at light loads and 350mV at 500mA), very-low ground current (225µA at 10mA output), and better than 1% initial accuracy.

Both regulator outputs can supply up to 500mA at the same time as long as each regulator's maximum junction temperature is not exceeded.

Key features include current limiting, overtemperature shut-down, and protection against reversed battery.

The MIC5212 is available in a fixed 3.3V/2.5V output voltage configuration. Other voltages are available; contact Micrel for details.

Features

- Fused lead frame SOIC-8
- Up to 500mA per regulator output
- Low quiescent current
- Low dropout voltage
- Tight load and line regulation
- Low temperature coefficient
- Current and thermal limiting
- Reversed input polarity protection

Applications

- Hard disk drives
- CD R/W
- Bar code scanners
- SMPS post regulator/DC-to-DC modules
- High-efficiency linear power supplies

Ordering Information

Part Number	Voltage	Accuracy	Junction Temp. Range*	Package
MIC5212-SJBM	3.3V/2.5V	1.0%	-40°C to +125°C	8-lead SOIC

Other voltages available. Contact Micrel for details.

Typical Application

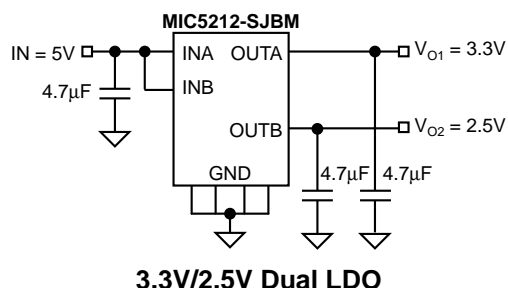

Pin Configuration

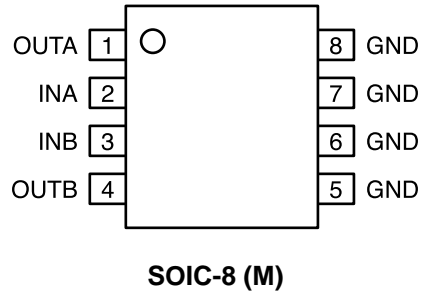

Pin Description

Pin Number	Pin Name	Pin Function
1	OUTA	Regulator A Output
2	INA	Regulator A Input
3	INB	Regulator B Input
4	OUTB	Regulator B Output
5, 6, 7, 8	GND	Ground

Absolute Maximum Ratings (Note 1)

Supply Input Voltage (V_{IN} A or B)	-20V to +20V
Power Dissipation (P_D)	Internally Limited
Storage Temperature Range	-60°C to +150°C
Lead Temperature (soldering, 5 sec.)	260°C

Operating Ratings (Note 2)

Supply Input Voltage (V_{IN})	2.5V to 16V
Junction Temperature (T_J)	-40°C to +125°C
Thermal Resistance (θ_{JA})	Note 3

Electrical Characteristics

Regulator A and B $V_{IN} = V_{OUT} + 1V$; $I_L = 100\mu A$; $C_L = 4.7\mu F$; $T_J = 25^\circ C$, **bold** values indicate $-40^\circ C \leq T_J \leq +125^\circ C$; unless noted.

Symbol	Parameter	Conditions	Min	Typical	Max	Units
V_O	Output Voltage Accuracy	variation from specified V_{OUT}	-1 -2		1 2	% %
$\Delta V_O / \Delta T$	Output Voltage Temperature Coefficient	Note 4		40		ppm/°C
$\Delta V_O / V_O$	Line Regulation	$V_{IN} = V_{OUT} + 1V$ to 16V		0.009	0.05 0.1	% / V % / V
$\Delta V_O / V_O$	Load Regulation	$I_L = 0.1mA$ to 500mA, Note 5		0.05	0.7 1.0	% %
$V_{IN} - V_O$	Dropout Voltage, Note 6 (per regulator)	$I_L = 150mA$ $I_L = 500mA$		175 350	275 350 500 600	mV mV mV mV
I_{GND}	Ground Pin Current, Note 7 (per regulator)	$I_L = 150mA$ $I_L = 500mA$		1.5 12	2.5 3.0 20 25	mA mA mA mA
PSRR	Ripple Rejection	$f = 120Hz$, $I_L = 150mA$		75		dB5
I_{LIMIT}	Current Limit	$V_{OUT} = 0V$		750	1000	mA
	Spectral Noise Density	$V_{OUT} = 2.5V$, $I_{OUT} = 50mA$, $C_{OUT} = 2.2\mu F$		500		nV/ \sqrt{Hz}

Note 1. Exceeding the absolute maximum rating may damage the device.

Note 2. The device is not guaranteed to function outside its operating rating.

Note 3. Absolute maximum ratings indicate limits beyond which damage to the component may occur. Electrical specifications do not apply when operating the device outside of its operating ratings. The maximum allowable power dissipation is a function of the maximum junction temperature, $T_{J(max)}$, the junction-to-ambient thermal resistance, θ_{JA} , and the ambient temperature, T_A . The maximum allowable power dissipation at any ambient temperature is calculated using: $P_{D(max)} = (T_{J(max)} - T_A) \div \theta_{JA}$. Exceeding the maximum allowable power dissipation will result in excessive die temperature, and the regulator will go into thermal shutdown. The θ_{JA} of the 8-lead SOIC (M) is 63°C/W mounted on a PC board (see "Thermal Considerations" section for further details).

Note 4. Output voltage temperature coefficient is defined as the worst case voltage change divided by the total temperature range.

Note 5. Regulation is measured at constant junction temperature using low duty cycle pulse testing. Parts are tested for load regulation in the load range from 0.1mA to 500mA. Changes in output voltage due to heating effects are covered by the thermal regulation specification.

Note 6. Dropout voltage is defined as the input to output differential at which the output voltage drops 2% below its nominal value measured at 1V differential.

Note 7. Ground pin current is the regulator quiescent current plus pass transistor base current. The total current drawn from the supply is the sum of the load current plus the ground pin current.

Typical Characteristics

**MIC5212-3.3 PSRR
150mA Load**

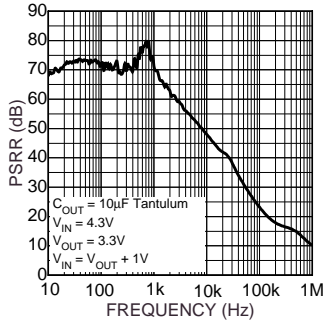

**MIC5212 PSRR
500mA Load**

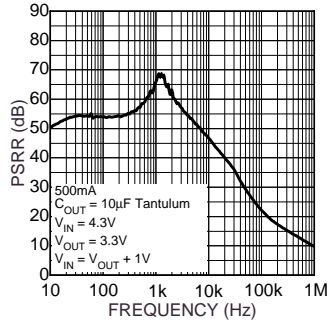

**MIC5212-2.5 PSRR
150mA Load**

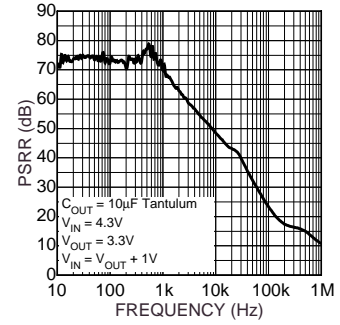

**MIC5212-2.5 PSRR
500mA Load**

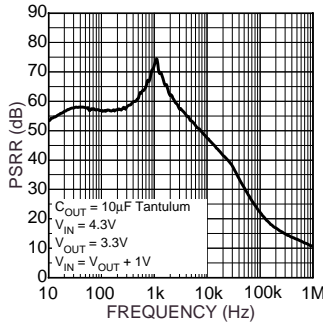

**Ground Current
vs. Temperature**

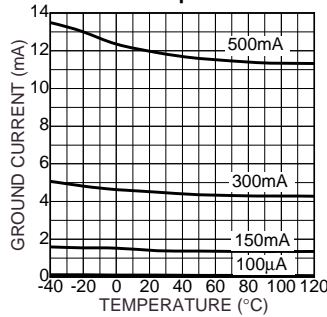

**S/C Current
vs. Temperature**

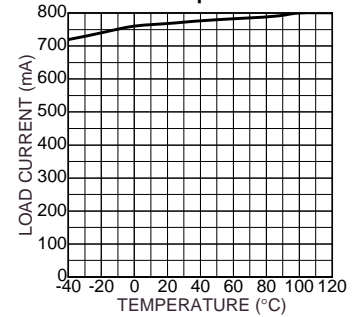

**Output Voltage
vs. Temperature**

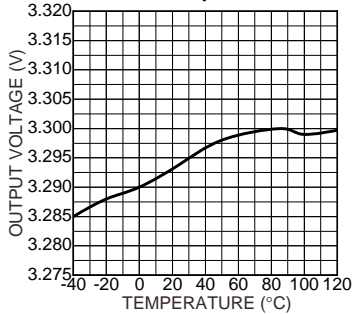

**Dropout Voltage
vs. Temperature**

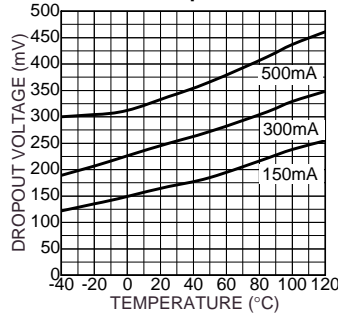

**Dropout Voltage
vs. Load Current**

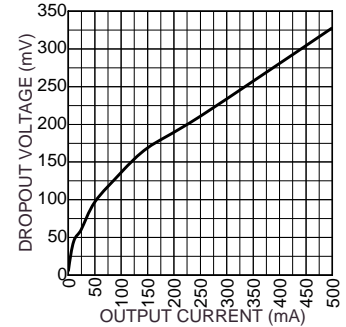

**Ground Current
vs. Load**

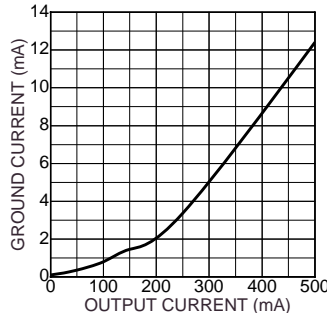

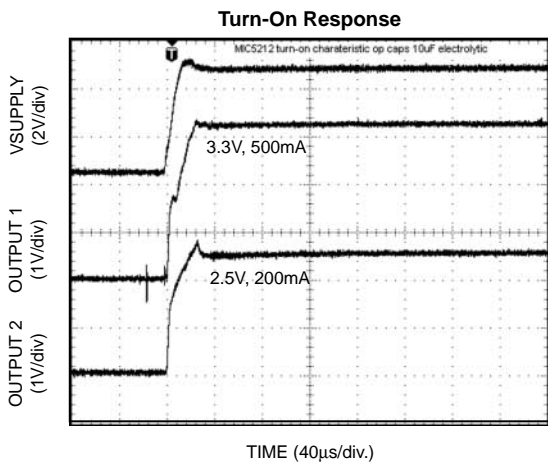
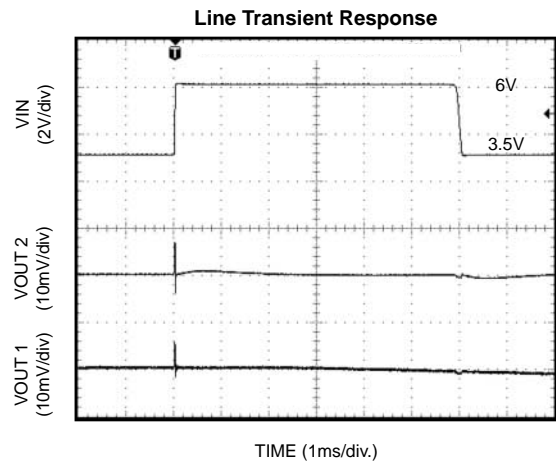
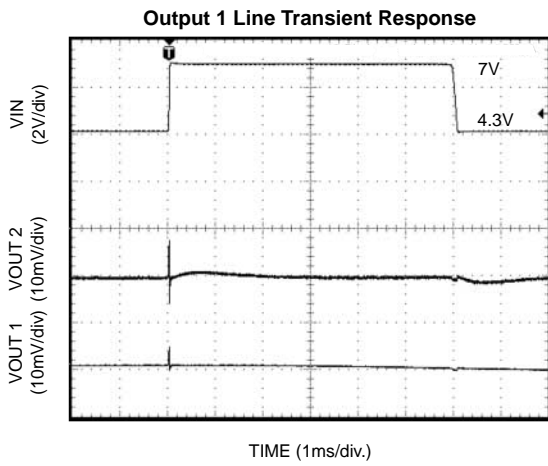
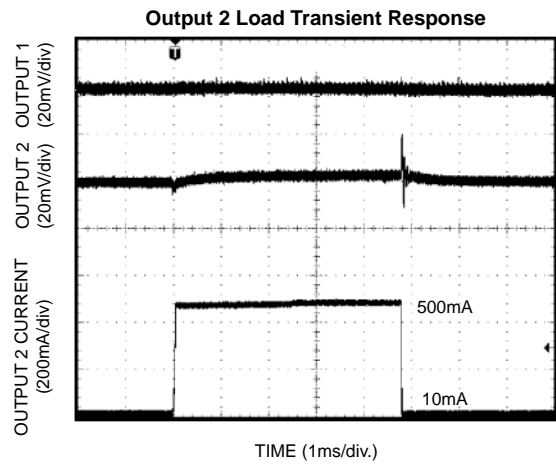
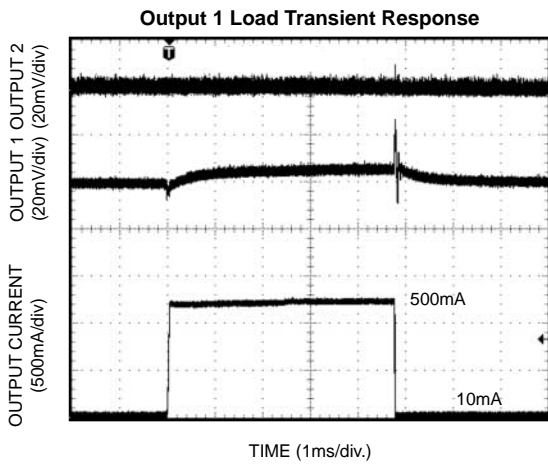

Functional Diagram

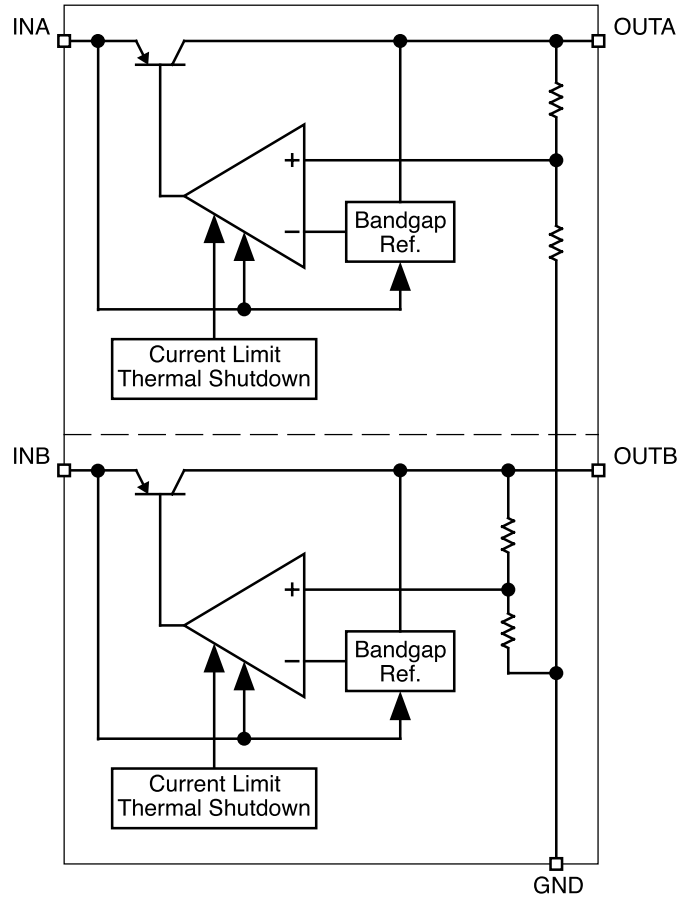

Applications Information

Input Capacitor

A 1 μ F capacitor should be placed from IN to GND if there is more than 10 inches of wire between the input and the AC filter capacitor or if a battery is used as the input.

Output Capacitor

An output capacitor is required between OUT and GND to prevent oscillation. 1.0 μ F minimum is recommended. Larger values improve the regulator's transient response. The output capacitor value may be increased without limit.

The output capacitor should have an ESR (Effective Series Resistance) of about 5 Ω or less and a resonant frequency above 1MHz. Ultra-low-ESR capacitors may cause a low-amplitude oscillation and/or underdamped transient response. Most tantalum or aluminum electrolytic capacitors are adequate; film types will work, but are more expensive. Since many aluminum electrolytic capacitors have electrolytes that freeze at about -30°C , solid tantalum capacitors are recommended for operation below -25°C .

At lower values of output current, less output capacitance is required for output stability. The capacitor can be reduced to 0.47 μ F for current below 10mA or 0.33 μ F for currents below 1mA.

No-Load Stability

The MIC5212 will remain stable and in regulation with no load (other than the internal voltage divider) unlike many other voltage regulators. This is especially important in CMOS RAM keep-alive applications.

Dual-Supply Operation

When used in dual supply systems where the regulator load is returned to a negative supply, the output voltage must be diode clamped to ground.

Power SO-8 Thermal Characteristics

One of the secrets of the MIC5212's performance is its power SO-8 package featuring half the thermal resistance of a standard SO-8 package. Lower thermal resistance means more output current or higher input voltage for a given package size.

Lower thermal resistance is achieved by joining the four ground leads with the die attach paddle to create a single-piece electrical and thermal conductor. This concept has been used by MOSFET manufacturers for years, proving very reliable and cost effective for the user.

Thermal resistance consists of two main elements, θ_{JC} (junction-to-case thermal resistance) and θ_{CA} (case-to-ambient thermal resistance). See Figure 1. θ_{JC} is the resistance from the die to the leads of the package. θ_{CA} is the resistance from the leads to the ambient air and it includes θ_{CS} (case-to-sink thermal resistance) and θ_{SA} (sink-to-ambient thermal resistance).

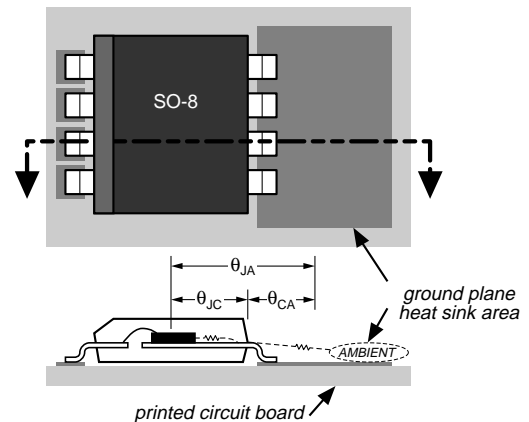

Figure 1. Thermal Resistance

Using the power SO-8 reduces the θ_{JC} dramatically and allows the user to reduce θ_{CA} . The total thermal resistance, θ_{JA} (junction-to-ambient thermal resistance) is the limiting factor in calculating the maximum power dissipation capability of the device. Typically, the power SO-8 has a θ_{JC} of $20^{\circ}\text{C}/\text{W}$, this is significantly lower than the standard SO-8 which is typically $75^{\circ}\text{C}/\text{W}$. θ_{CA} is reduced because pins 5 through 8 can now be soldered directly to a ground plane which significantly reduces the case-to-sink thermal resistance and sink to ambient thermal resistance.

Low dropout linear regulators from Micrel are rated to a maximum junction temperature of 125°C. It is important not to exceed this maximum junction temperature during operation of the device. To prevent this maximum junction temperature from being exceeded, the appropriate ground plane heat sink must be used.

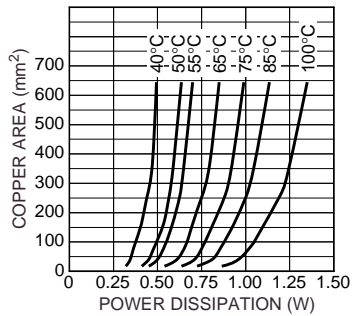

Figure 2. Copper Area vs. Power-SO Power Dissipation (ΔT_{JA})

Figure 2 shows copper area versus power dissipation with each trace corresponding to a different temperature rise above ambient.

From these curves, the minimum area of copper necessary for the part to operate safely can be determined. The maximum allowable temperature rise must be calculated to determine operation along which curve.

$$\Delta T = T_{J(max)} - T_{A(max)}$$

$$T_{J(max)} = 125^{\circ}\text{C}$$

$$T_{A(max)} = \text{maximum ambient operating temperature}$$

For example, the maximum ambient temperature is 50°C, the ΔT is determined as follows:

$$\Delta T = 125^{\circ}\text{C} - 50^{\circ}\text{C}$$

$$\Delta T = 75^{\circ}\text{C}$$

Using Figure 2, the minimum amount of required copper can be determined based on the required power dissipation. Power dissipation in a linear regulator is calculated as follows:

$$P_D = (V_{IN1} - V_{OUT1}) \times I_{OUT1} + V_{IN1} \times I_{GND1} + (V_{IN2} - V_{OUT2}) \times I_{OUT2} + V_{IN2} \times I_{GND2}$$

With a common 5V input, a 3.3V, 300mA output on LDO 1 and a 2.5V, 150mA output on LDO 2, power dissipation is as follows:

$$P_D = (5V - 3.3V) \times 300\text{mA} + 5V \times 5\text{mA} + (5V - 2.5V) \times 150\text{mA} + 5V \times 1.8\text{mA}$$

$$P_D = 0.919\text{W}$$

From Figure 2, the minimum amount of copper required to operate this application at a ΔT of 75°C is 500mm².

Quick Method

Determine the power dissipation requirements for the design along with the maximum ambient temperature at which the device will be operated. Refer to Figure 3, which shows safe operating curves for three different ambient temperatures: 25°C, 50°C and 85°C. From these curves, the minimum amount of copper can be determined by knowing the maximum power dissipation required. If the maximum ambient temperature is 50°C and the power dissipation is as above, 920mW, the curve in Figure 3 shows that the required area of copper is 500mm².

The θ_{JA} of this package is ideally 63°C/W, but it will vary depending upon the availability of copper/ground plane to which it is attached.

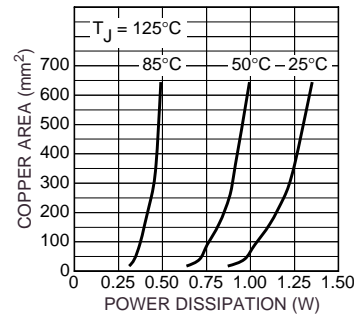
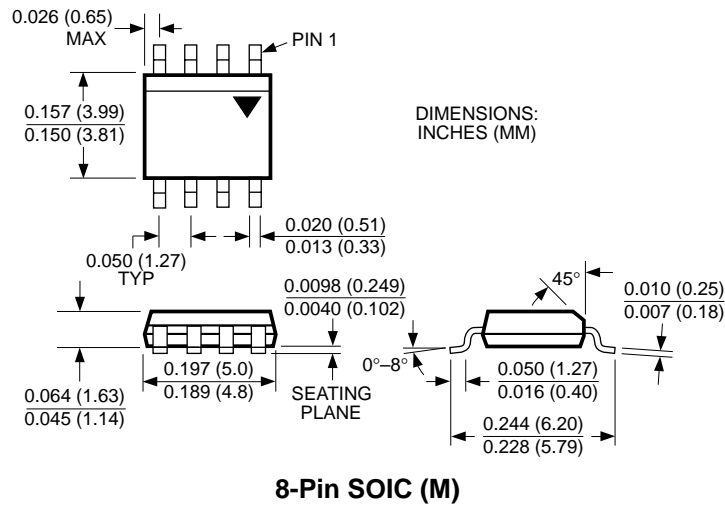

Figure 3. Copper Area vs. Power-SO Power Dissipation (T_A)

Package Information



MICREL, INC. 1849 FORTUNE DRIVE SAN JOSE, CA 95131 USA

TEL + 1 (408) 944-0800 FAX + 1 (408) 944-0970 WEB <http://www.micrel.com>

The information furnished by Micrel in this datasheet is believed to be accurate and reliable. However, no responsibility is assumed by Micrel for its use. Micrel reserves the right to change circuitry and specifications at any time without notification to the customer.

Micrel Products are not designed or authorized for use as components in life support appliances, devices or systems where malfunction of a product can reasonably be expected to result in personal injury. Life support devices or systems are devices or systems that (a) are intended for surgical implant into the body or (b) support or sustain life, and whose failure to perform can be reasonably expected to result in a significant injury to the user. A Purchaser's use or sale of Micrel Products for use in life support appliances, devices or systems is at Purchaser's own risk and Purchaser agrees to fully indemnify Micrel for any damages resulting from such use or sale.

© 2003 Micrel, Incorporated.

Mouser Electronics

Authorized Distributor

Click to View Pricing, Inventory, Delivery & Lifecycle Information:

[Micrel:](#)

[MIC5212-SJYM TR](#)

[Microchip:](#)

[MIC5212-SJYM](#)