

Loc		DIST		REVISIONS			
P	LTR	DESCRIPTION	DATE	DWN	APVD		
AD	00	AM3	REVISED PER ECO-11-004587	11MAR11	RK	HMR	

- FOR ADDITIONAL SPECIFICATIONS SEE AMP PRODUCT SPEC 108-7532.
- SWITCH SHOWN IN OPEN POSITION.
- ALL CHARACTERS AND ROCKERS ARE WHITE, HOUSING IS BLUE.
- STAMPING WILL VARY ON 2 AND 3 POSITION SIDES DUE TO SPACE RESTRICTIONS.

△5 .315 DIMENSION APPLIES AT TERMINAL TIPS.
 TERMINALS ARE .300^{+.010}-.000 AT MOUNTING SURFACE.
 △6 STRIPPABLE TRANSPARENT SEAL, SEE FIG 1.

△7	OBSOLETE	FIG 6				
			1.08	10	6-435640-1	
			.58	5	6-435640-0	
	△	FIG 7	.48	4	5-435640-9	
			.88	8	5-435640-8	
			.98	9	5-435640-7	
	△	FIG 5	.68	6	5-435640-6	
			.58	5	5-435640-5	
			.48	4	5-435640-4	
		FIG 2	.88	8	5-435640-3	
		FIG 5	.88	8	5-435640-2	
			1.08	10	5-435640-1	
		FIG 3	.88	8	5-435640-0	
			.88	8	4-435640-9	
			.58	5	4-435640-8	
		NONE	1.08	10	4-435640-7	
			1.28	12	4-435640-3	
			1.08	10	4-435640-1	
			.98	9	4-435640-0	
			.88	8	3-435640-9	
			.78	7	3-435640-8	
			.68	6	3-435640-7	
			.58	5	3-435640-6	
			.48	4	3-435640-5	
			.38	3	3-435640-4	
			.28	2	3-435640-3	
		FIG 4	1.28	12	3-435640-2	
			.38	3	3-435640-0	
			.28	2	2-435640-9	
		FIG 2	.78	7	2-435640-2	
			1.08	10	435640-7	
			.98	9	435640-6	
			.88	8	435640-5	
			.68	6	435640-4	
			.58	5	435640-3	
			.48	4	435640-2	
			.78	7	435640-1	
		TOP MARKING				
		PROTECTIVE SEAL	A	NO OF POSN		
					PART NO.	

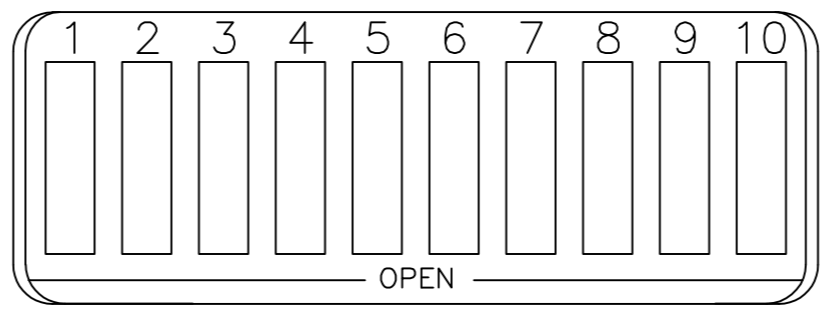
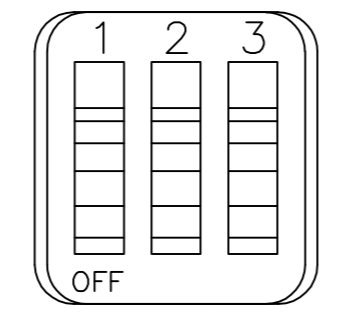
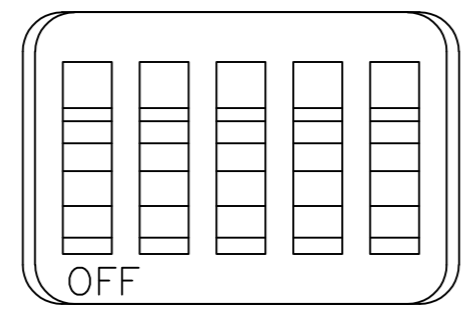
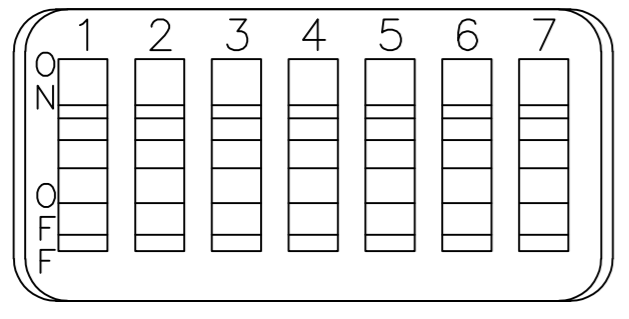
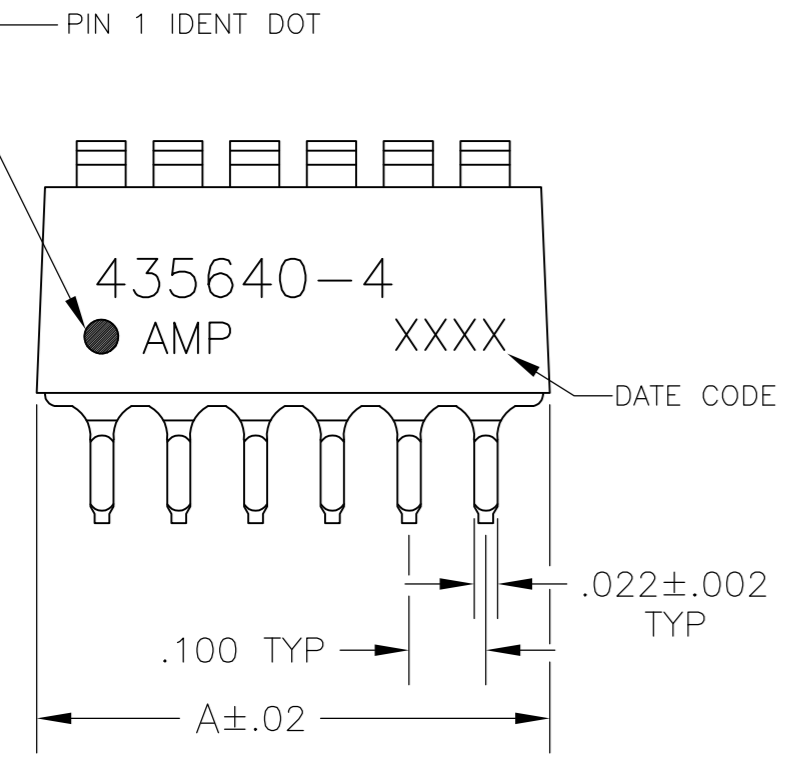
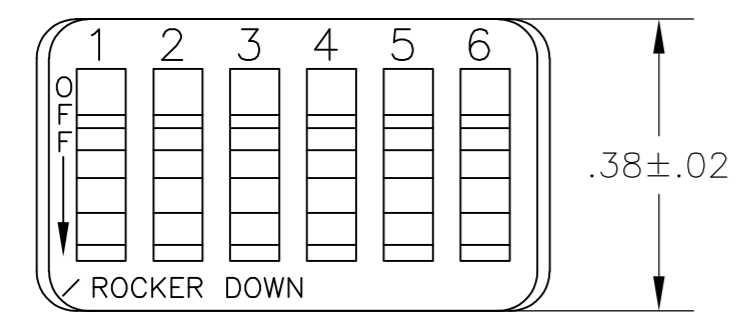
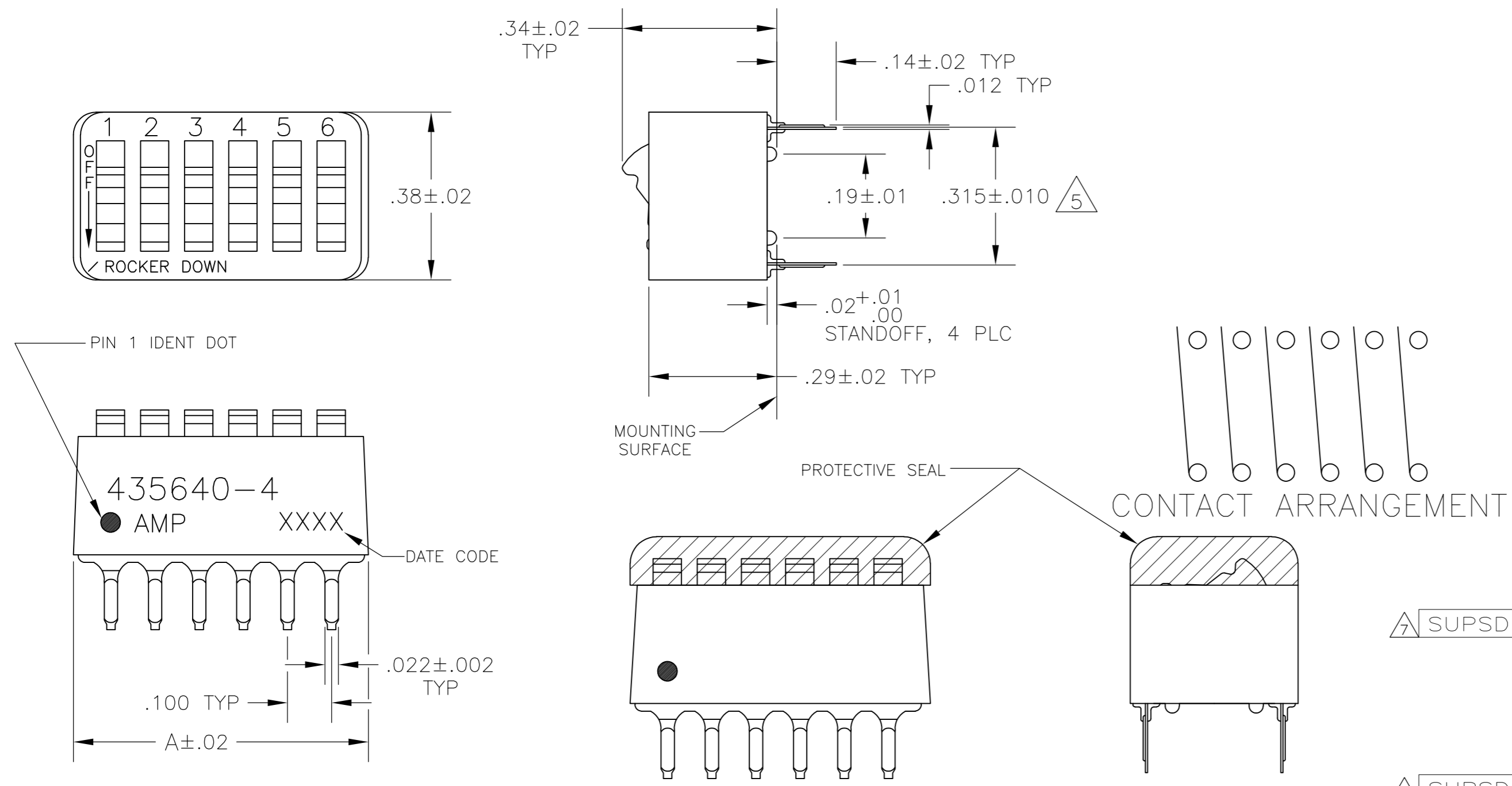

FIG 2

FIG 3

FIG 4

FIG 5

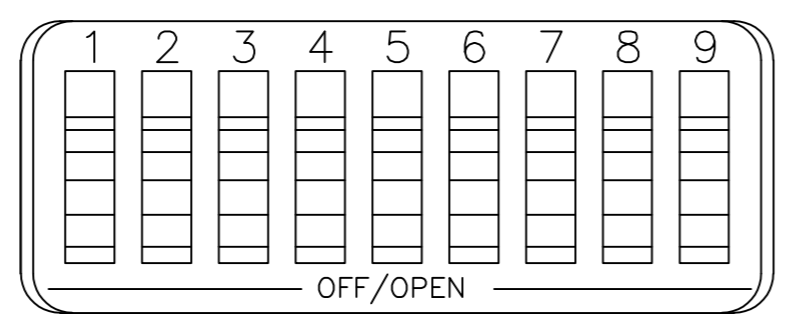
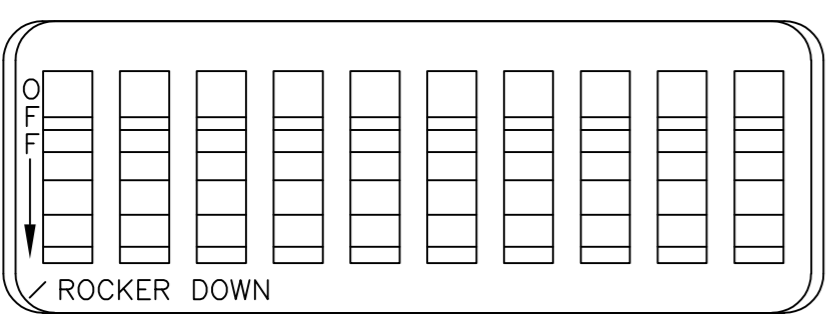

FIG 6

FIG 7

△7 OBSOLETE PARTS: OBSOLETE CIS STREAMLINING PER D.RENAUD/D.SINISI

THIS DRAWING IS A CONTROLLED DOCUMENT.		DWN R.TALLEY 15NOV89		
DIMENSIONS: INCHES		CHK R.L.MILLER 06MARGO		
TOLERANCES UNLESS OTHERWISE SPECIFIED:		APVD H.LEITER 06MARGO	NAME	
0 PLC ± -		PRODUCT SPEC	SWITCH ASSY, DIP, TYPE C, 7100 SERIES, SPST, STANDARD	
1 PLC ± -		APPLICATION SPEC	SIZE A2	CAGE CODE 00779
2 PLC ± -		WEIGHT -	DRAWING NO C=435640	RESTRICTED TO -
3 PLC ± .005			SCALE 4:1	SHEET 1 of 1
4 PLC ± -			REV AM3	
ANGLES ± -				
FINISH				
CONTACTS: PLATED .000030 MIN GOLD IN CONTACT AREA OVER .000050 MIN NICKEL				
MATERIAL: HOUSING & ROCKERS; POLYESTER CONTACTS; COPPER ALLOY				

Mouser Electronics

Authorized Distributor

Click to View Pricing, Inventory, Delivery & Lifecycle Information:

[TE Connectivity:](#)

[5-435640-1](#)