

# NL17SV02

## Single 2-Input NOR Gate

The NL17SV02 is an ultra-high performance 2-Input NOR gate manufactured in 0.35  $\mu\text{m}$  technology, with excellent performance down to 0.9 V. This device is ideal for extremely high speed and high-drive applications. Additionally, limitations of board space are no longer a constraint. The very small SOT-553 makes this device fit most tight designs and spaces.

### Features

- Extremely High Speed:  $t_{PD} = 1.0 \text{ ns (Typ) @ } V_{CC} = 3.3 \text{ V}$
- Designed for 0.9 to 3.6 V Operation
- Overvoltage Tolerance (OVT)\* Input Pins Permits Logic Translation
- Balanced  $\pm 24 \text{ mA}$  Output Drive @  $V_{CC} 3.3 \text{ Volts}$
- Near Zero Static Supply Current
- Ultra-Tiny SOT-553 5 Pin Package only 1.6 x 1.6 x 0.6 mm
- These Devices are Pb-Free and are RoHS Compliant

### Typical Applications

- Cellular
- Digital Camera
- PDA
- Digital Video

### Industry Leadership

- Functionally Similar to NC7SV02 and SN74AUC1G02

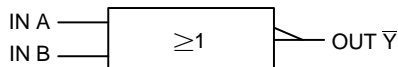

Figure 1. Logic Symbol

### FUNCTION TABLE

Inputs		Output
A	B	$\bar{Y}$
L	L	H
L	H	L
H	L	L
H	H	L



ON Semiconductor®

<http://onsemi.com>

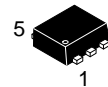

SOT-553  
CASE 463B

### MARKING DIAGRAM

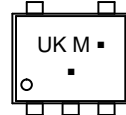

UK = Specific Device Code

M = Date Code

■ = Pb-Free Package

(Note: Microdot may be in either location)

### PIN DIAGRAM

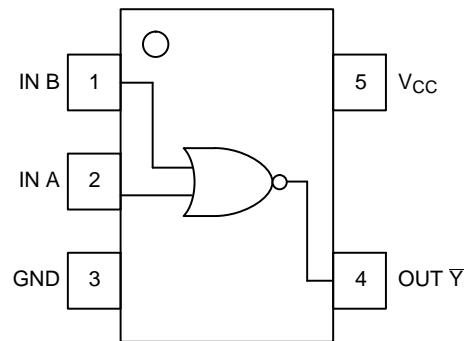

### PIN ASSIGNMENT

PIN #	FUNCTION
1	IN B
2	IN A
3	GND
4	OUT $\bar{Y}$
5	$V_{CC}$

### ORDERING INFORMATION

Device	Package	Shipping†
NL17SV02XV5T2G	SOT-553 (Pb-Free)	4000 Tape & Reel (178 mm)

†For information on tape and reel specifications, including part orientation and tape sizes, please refer to our Tape and Reel Packaging Specifications Brochure, BRD8011/D.

\*Overvoltage Tolerance (OVT) enables input pins to function outside (higher) of their operating voltages, with no damage to the devices or to signal integrity.

# NL17SV02

## MAXIMUM RATINGS

Symbol	Rating	Value	Units
V <sub>CC</sub>	DC Supply Voltage	-0.5 to +4.6	V
V <sub>I</sub>	DC Input Voltage	-0.5 to +4.6	V
V <sub>O</sub>	DC Output Voltage	-0.5 to V <sub>CC</sub> +0.5	V
I <sub>IK</sub>	DC Input Diode Current V <sub>IN</sub> < 0 V	-50	mA
I <sub>OK</sub>	DC Output Diode Current V <sub>OUT</sub> < 0 V V <sub>OUT</sub> > V <sub>CC</sub>	-50 +50	mA
I <sub>O</sub>	DC Output Sink Current	±50	mA
I <sub>CC</sub>	DC Supply Current per Supply Pin	±50	mA
I <sub>GND</sub>	DC Ground Current per Ground Pin	±50	mA
T <sub>STG</sub>	Storage Temperature Range	-65 to +150	°C
T <sub>L</sub>	Lead Temperature, 1.0 mm from Case for 10 seconds	260	°C
T <sub>J</sub>	Junction Temperature Under Bias	+150	°C
θ <sub>JA</sub>	Thermal Resistance (Note 1)	250	°C/W
P <sub>D</sub>	Power Dissipation in Still Air at 85°C	250	mW
MSL	Moisture Sensitivity	Level 1	
F <sub>R</sub>	Flammability Rating Oxygen index: 28 to 34	UL 94 V-0 @ 0125 in	
V <sub>ESD</sub>	ESD Withstand Voltage Human Body Model (Note 2) Machine Model (Note 3)	3000 200	V

Stresses exceeding those listed in the Maximum Ratings table may damage the device. If any of these limits are exceeded, device functionality should not be assumed, damage may occur and reliability may be affected.

1. Measured with minimum pad spacing on an FR4 board, using 10 mm-by-1 inch, 2 ounce copper trace no air flow.
2. Tested to EIA/JESD22-A114-A.
3. Tested to EIA/JESD22-A115-A.

## RECOMMENDED OPERATING CONDITIONS

Symbol	Parameter	Min	Max	Units
V <sub>CC</sub>	Positive DC Supply Voltage	0.9	3.6	V
V <sub>IN</sub>	Digital Input Voltage	0	3.6	V
V <sub>out</sub>	Output Voltage	0	V <sub>CC</sub>	V
I <sub>OH</sub> /I <sub>OL</sub>	Output Current V <sub>CC</sub> = 3.0 V to 3.6 V V <sub>CC</sub> = 2.3 V to 2.7 V V <sub>CC</sub> = 1.65 V to 1.95 V V <sub>CC</sub> = 1.4 V to 1.6 V V <sub>CC</sub> = 1.1 V to 1.3 V V <sub>CC</sub> = 0.9 V		±24 ±18 ±6 ±4 ±2 ±0.1	mA
t <sub>A</sub>	Operating Temperature Range. All Package Types	-40	+85	°C
t <sub>r</sub> , t <sub>f</sub>	Input Rise or Fall Time V <sub>CC</sub> = 3.3V ± 0.3 V	0	10	nS/V

Functional operation above the stresses listed in the Recommended Operating Ranges is not implied. Extended exposure to stresses beyond the Recommended Operating Ranges limits may affect device reliability.

# NL17SV02

## DC CHARACTERISTICS – Digital Section (Voltages Referenced to GND)

Symbol	Parameter	Condition	V <sub>CC</sub>	T <sub>A</sub> = 25°C		T <sub>A</sub> = -40 to 85°C		Units
				Min	Max	Min	Max	
V <sub>IH</sub>	High Level Input Voltage		0.90 1.10 ≤ V <sub>CC</sub> ≤ 1.30 1.40 ≤ V <sub>CC</sub> ≤ 1.60 1.65 ≤ V <sub>CC</sub> ≤ 1.95 2.30 ≤ V <sub>CC</sub> ≤ 2.70 2.70 ≤ V <sub>CC</sub> ≤ 3.60	0.65 x V <sub>CC</sub> 0.65 x V <sub>CC</sub> 0.65 x V <sub>CC</sub> 0.65 x V <sub>CC</sub> 1.6 2.0		0.65 x V <sub>CC</sub> 0.65 x V <sub>CC</sub> 0.65 x V <sub>CC</sub> 0.65 x V <sub>CC</sub> 1.6 2.0		V
V <sub>IL</sub>	Low Level Input Voltage		0.90 1.10 ≤ V <sub>CC</sub> ≤ 1.30 1.40 ≤ V <sub>CC</sub> ≤ 1.60 1.65 ≤ V <sub>CC</sub> ≤ 1.95 2.30 ≤ V <sub>CC</sub> ≤ 2.70 2.70 ≤ V <sub>CC</sub> ≤ 3.60		0.35 x V <sub>CC</sub> 0.35 x V <sub>CC</sub> 0.35 x V <sub>CC</sub> 0.35 x V <sub>CC</sub> 0.7 0.8		0.35 x V <sub>CC</sub> 0.35 x V <sub>CC</sub> 0.35 x V <sub>CC</sub> 0.35 x V <sub>CC</sub> 0.7 0.8	V
V <sub>OH</sub>	High Level Output Voltage	I <sub>OH</sub> = -100 μA	0.90 1.10 ≤ V <sub>CC</sub> ≤ 1.30 1.40 ≤ V <sub>CC</sub> ≤ 1.60 1.65 ≤ V <sub>CC</sub> ≤ 1.95 2.30 ≤ V <sub>CC</sub> ≤ 2.70 2.70 ≤ V <sub>CC</sub> ≤ 3.60	V <sub>CC</sub> - 0.1 V <sub>CC</sub> - 0.1 V <sub>CC</sub> - 0.2 V <sub>CC</sub> - 0.2 V <sub>CC</sub> - 0.2 V <sub>CC</sub> - 0.2		V <sub>CC</sub> - 0.1 V <sub>CC</sub> - 0.1 V <sub>CC</sub> - 0.2 V <sub>CC</sub> - 0.2 V <sub>CC</sub> - 0.2 V <sub>CC</sub> - 0.2		V
		I <sub>OH</sub> = -2.0 mA	1.10 ≤ V <sub>CC</sub> ≤ 1.30	0.75 x V <sub>CC</sub>		0.75 x V <sub>CC</sub>		
		I <sub>OH</sub> = -4.0 mA	1.40 ≤ V <sub>CC</sub> ≤ 1.60	0.75 x V <sub>CC</sub>		0.75 x V <sub>CC</sub>		
		I <sub>OH</sub> = -6.0 mA	1.65 ≤ V <sub>CC</sub> ≤ 1.95 2.30 ≤ V <sub>CC</sub> ≤ 2.70	1.25 2.0		1.25 2.0		
		I <sub>OH</sub> = -12 mA	2.30 ≤ V <sub>CC</sub> ≤ 2.70 2.70 < V <sub>CC</sub> ≤ 3.60	1.8 2.2		1.8 2.2		
		I <sub>OH</sub> = -18 mA	2.30 ≤ V <sub>CC</sub> ≤ 2.70 2.70 < V <sub>CC</sub> ≤ 3.60	1.7 2.4		1.7 2.4		
		I <sub>OH</sub> = -24 mA	2.70 ≤ V <sub>CC</sub> ≤ 3.60	2.2		2.2		
V <sub>OL</sub>	Low Level Output Voltage	I <sub>OL</sub> = 100 μA	0.90 1.10 ≤ V <sub>CC</sub> ≤ 1.30 1.40 ≤ V <sub>CC</sub> ≤ 1.60 1.65 ≤ V <sub>CC</sub> ≤ 1.95 2.30 ≤ V <sub>CC</sub> ≤ 2.70 2.70 ≤ V <sub>CC</sub> ≤ 3.60		0.1 0.1 0.2 0.2 0.2 0.2		0.1 0.1 0.2 0.2 0.2 0.2	V
		I <sub>OL</sub> = 2.0 mA	1.10 ≤ V <sub>CC</sub> ≤ 1.30		0.25 x V <sub>CC</sub>		0.25 x V <sub>CC</sub>	
		I <sub>OL</sub> = 4.0 mA	1.40 ≤ V <sub>CC</sub> ≤ 1.60		0.25 x V <sub>CC</sub>		0.25 x V <sub>CC</sub>	
		I <sub>OL</sub> = 6.0 mA	1.65 ≤ V <sub>CC</sub> ≤ 1.95		0.3		0.3	
		I <sub>OL</sub> = 12 mA	2.30 ≤ V <sub>CC</sub> ≤ 2.70 2.70 < V <sub>CC</sub> ≤ 3.60		0.4 0.4		0.4 0.4	
		I <sub>OL</sub> = 18 mA	2.30 ≤ V <sub>CC</sub> ≤ 2.70 2.70 < V <sub>CC</sub> ≤ 3.60		0.6 0.4		0.6 0.4	
		I <sub>OL</sub> = 24 mA	2.70 ≤ V <sub>CC</sub> ≤ 3.60		0.55		0.55	
I <sub>IN</sub>	Input Leakage Current	0 = V <sub>I</sub> = 3.6 V	0.90 to 3.60		±0.1		±0.9	μA
I <sub>OFF</sub>	Power Off Leakage Current		0		1		5	μA
I <sub>CC</sub>	Quiescent Supply Current	V <sub>I</sub> = V <sub>CC</sub> or GND	0.90 to 3.60		0.9		5	μA

# NL17SV02

## AC CHARACTERISTICS (Input $t_r = t_f = 3.0$ nS)

Symbol	Parameter	-40°C		25°C			85°C		Units
		Condition	V <sub>CC</sub>	Min	Typ	Max	Min	Max	
T <sub>PHL</sub> , T <sub>PLH</sub>	Propagation Delay	C <sub>L</sub> = 15 pF, R <sub>L</sub> = 1.0 MΩ	0.90		13				nS
		C <sub>L</sub> = 15 pF, R <sub>L</sub> = 2.0 kΩ	1.10 ≤ V <sub>CC</sub> ≤ 1.30 1.40 ≤ V <sub>CC</sub> ≤ 1.60	3.0 1.0	6.0 3.2	15 8.7	1.0 1.0	18.6 9.7	nS
		C <sub>L</sub> = 30 pF, R <sub>L</sub> = 500 Ω	1.65 ≤ V <sub>CC</sub> ≤ 1.95 2.30 ≤ V <sub>CC</sub> ≤ 2.70 2.70 ≤ V <sub>CC</sub> ≤ 3.60	1.0 0.8 0.7	2.0 1.2 1.0	6.0 4.1 3.3	1.0 0.7 0.6	6.8 4.7 4.0	nS
C <sub>IN</sub>	Input Capacitance		0		2.0				pF
C <sub>OUT</sub>	Output Capacitance		0		4.5				pF
C <sub>PD</sub>	Power Dissipation Capacitance	V <sub>I</sub> = 0 V or V <sub>CC</sub> F = 10 MHz	0.90 to 3.60		20				pF

## DEVICE JUNCTION TEMPERATURE VERSUS TIME TO 0.1% BOND FAILURES

Junction, Temperature °C	Time, Hours	Time, Years
80	1,032,200	117.8
90	419,300	47.9
100	178,700	20.4
110	79,600	9.4
120	37,000	4.2
130	17,800	2.0
140	8,900	1.0

# NL17SV02

## PACKAGE DIMENSIONS

### SOT-553, 5 LEAD CASE 463B ISSUE C

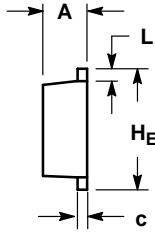
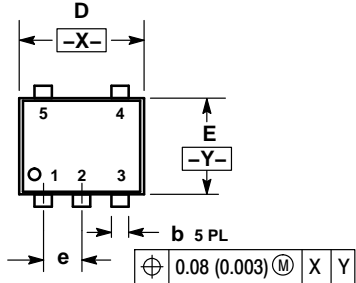

#### NOTES:

1. DIMENSIONING AND TOLERANCING PER ANSI Y14.5M, 1982.
2. CONTROLLING DIMENSION: MILLIMETERS
3. MAXIMUM LEAD THICKNESS INCLUDES LEAD FINISH THICKNESS. MINIMUM LEAD THICKNESS IS THE MINIMUM THICKNESS OF BASE MATERIAL.

DIM	MILLIMETERS			INCHES		
	MIN	NOM	MAX	MIN	NOM	MAX
A	0.50	0.55	0.60	0.020	0.022	0.024
b	0.17	0.22	0.27	0.007	0.009	0.011
c	0.08	0.13	0.18	0.003	0.005	0.007
D	1.55	1.60	1.65	0.061	0.063	0.065
E	1.15	1.20	1.25	0.045	0.047	0.049
e	0.50 BSC			0.020 BSC		
L	0.10	0.20	0.30	0.004	0.008	0.012
HE	1.55	1.60	1.65	0.061	0.063	0.065

### RECOMMENDED SOLDERING FOOTPRINT\*

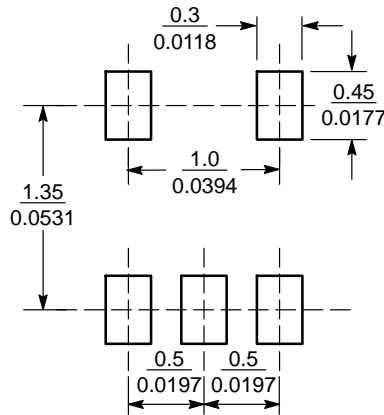

SCALE 20:1 (mm/inches)

\*For additional information on our Pb-Free strategy and soldering details, please download the ON Semiconductor Soldering and Mounting Techniques Reference Manual, SOLDERRM/D.

ON Semiconductor and  are registered trademarks of Semiconductor Components Industries, LLC (SCILLC). SCILLC owns the rights to a number of patents, trademarks, copyrights, trade secrets, and other intellectual property. A listing of SCILLC's product/patent coverage may be accessed at [www.onsemi.com/site/pdf/Patent-Marking.pdf](http://www.onsemi.com/site/pdf/Patent-Marking.pdf). SCILLC reserves the right to make changes without further notice to any products herein. SCILLC makes no warranty, representation or guarantee regarding the suitability of its products for any particular purpose, nor does SCILLC assume any liability arising out of the application or use of any product or circuit, and specifically disclaims any and all liability, including without limitation special, consequential or incidental damages. "Typical" parameters which may be provided in SCILLC data sheets and/or specifications can and do vary in different applications and actual performance may vary over time. All operating parameters, including "Typicals" must be validated for each customer application by customer's technical experts. SCILLC does not convey any license under its patent rights nor the rights of others. SCILLC products are not designed, intended, or authorized for use as components in systems intended for surgical implant into the body, or other applications intended to support or sustain life, or for any other application in which the failure of the SCILLC product could create a situation where personal injury or death may occur. Should Buyer purchase or use SCILLC products for any such unintended or unauthorized application, Buyer shall indemnify and hold SCILLC and its officers, employees, subsidiaries, affiliates, and distributors harmless against all claims, costs, damages, and expenses, and reasonable attorney fees arising out of, directly or indirectly, any claim of personal injury or death associated with such unintended or unauthorized use, even if such claim alleges that SCILLC was negligent regarding the design or manufacture of the part. SCILLC is an Equal Opportunity/Affirmative Action Employer. This literature is subject to all applicable copyright laws and is not for resale in any manner.

### PUBLICATION ORDERING INFORMATION

#### LITERATURE FULFILLMENT:

Literature Distribution Center for ON Semiconductor  
P.O. Box 5163, Denver, Colorado 80217 USA  
Phone: 303-675-2175 or 800-344-3860 Toll Free USA/Canada  
Fax: 303-675-2176 or 800-344-3867 Toll Free USA/Canada  
Email: [orderlit@onsemi.com](mailto:orderlit@onsemi.com)

N. American Technical Support: 800-282-9855 Toll Free  
USA/Canada  
Europe, Middle East and Africa Technical Support:  
Phone: 421 33 790 2910  
Japan Customer Focus Center  
Phone: 81-3-5817-1050

ON Semiconductor Website: [www.onsemi.com](http://www.onsemi.com)

Order Literature: <http://www.onsemi.com/orderlit>

For additional information, please contact your local Sales Representative

# Mouser Electronics

Authorized Distributor

Click to View Pricing, Inventory, Delivery & Lifecycle Information:

[ON Semiconductor:](#)

[NL17SV02XV5T2G](#)