

DESCRIPTION: FEMALE - DIP SOLDER / MACHINED - PREMIUM

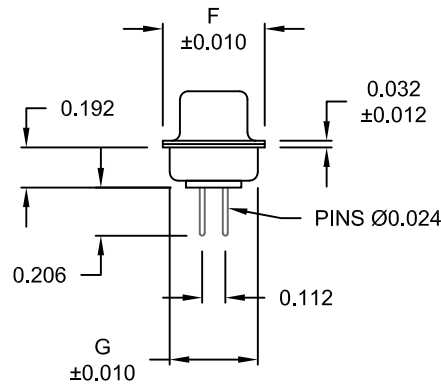
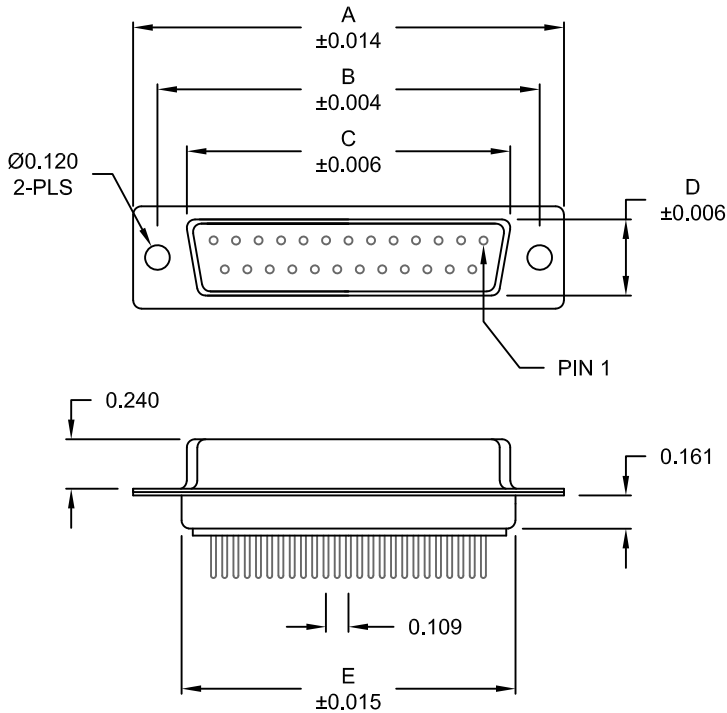

No. OF PINS	DIMENSIONS						
	A	B	C	D	E	F	G
9	1.213	0.984	0.642	0.315	0.760	0.496	0.429
	30.80	24.99	16.30	8.00	19.30	12.60	10.90
15	1.541	1.312	0.969	0.315	1.083	0.496	0.429
	39.15	33.32	24.60	8.00	27.51	12.60	10.90
25	2.088	1.852	1.512	0.315	1.630	0.496	0.429
	53.04	47.04	38.40	8.00	41.40	12.60	10.90
37	2.729	2.500	2.157	0.315	2.276	0.496	0.429
	69.32	63.50	54.80	8.00	57.81	12.60	10.90
50	2.635	2.406	2.059	0.425	2.182	0.598	0.535
	66.93	61.11	52.30	10.80	55.42	15.20	13.60

172-YYY-212RYY1

SERIES \_\_\_\_\_  
 POSITIONS \_\_\_\_\_  
 009 \_\_\_\_\_  
 015 \_\_\_\_\_  
 025 \_\_\_\_\_  
 037 \_\_\_\_\_  
 050 \_\_\_\_\_  
 GENDER \_\_\_\_\_  
 2 = FEMALE  
 TERMINATION \_\_\_\_\_  
 1 = DIP SOLDER  
 SHELL PLATING \_\_\_\_\_  
 2 = TIN  
 RoHS COMPLIANT \_\_\_\_\_  
 HARDWARE OPTIONS \_\_\_\_\_  
 00 = NO HARDWARE  
 01 = .065" CLINCH NUT (BOARD SIDE)  
 02 = .250" CLINCH NUT (BOARD SIDE)  
 03 = .250" CLINCH NUT (MOUNTING SIDE)  
 05 = .237" 4-40 BOARD LOCK  
 90 = .237" 4-40 BOARD LOCK  
 FOR 0.093" BOARD MAX.  
 91 = .237" 4-40 SPACER/ BOARD LOCK  
 92 = .237" 4-40 SPACER/ BOARD LOCK  
 FOR 0.093" BOARD MAX.  
 PLATING OPTIONS \_\_\_\_\_  
 1 = GOLD FLASH  
 2 = 30MICRO-INCH GOLD

**MATERIAL:**

SHELL: STEEL, TIN  
 INSULATOR: UL 94V-O RATED, PA6T  
 PROCESS TEMP.: 260°C  
 CONTACT: BRASS (FLOATING CONTACTS)

**ELECTRICAL:**

CURRENT RATING: 5 AMPS  
 CONTACT RESISTANCE: 15 mOhms Max.  
 INSULATION RESISTANCE: 1,000 MOhms Min.  
 VOLTAGE: 500VAC FOR 1 MINUTE  
 TEMPERATURE: -50° C TO 100° C

DO NOT SCALE FROM DRAWING



THESE DRAWINGS AND SPECIFICATIONS ARE THE PROPERTY OF NorComp AND SHALL NOT BE REPRODUCED, COPIED OR USED AS THE BASIS FOR THE MANUFACTURE OF SALE OF APPARATUS WITHOUT WRITTEN PERMISSION.

DRAWN: PAM JENKINS		DATE: 09-12-05	
SCALE: NTS	SHEET 1	OF 3	REV 18
DWG NO. 172-YYY-212RYY1			

RoHS COMPLIANT

NorComp

DESCRIPTION: PCB LAYOUT - STANDARD "D" - MALE & FEMALE

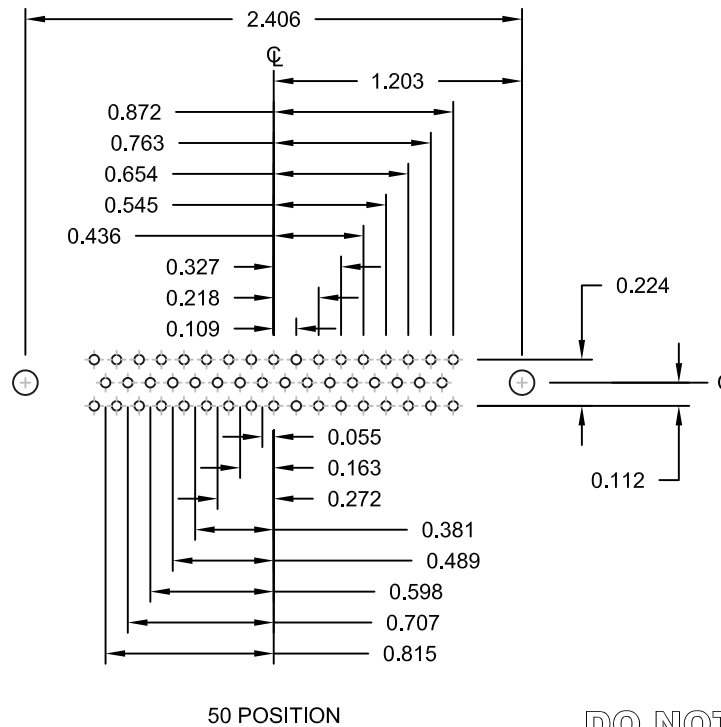
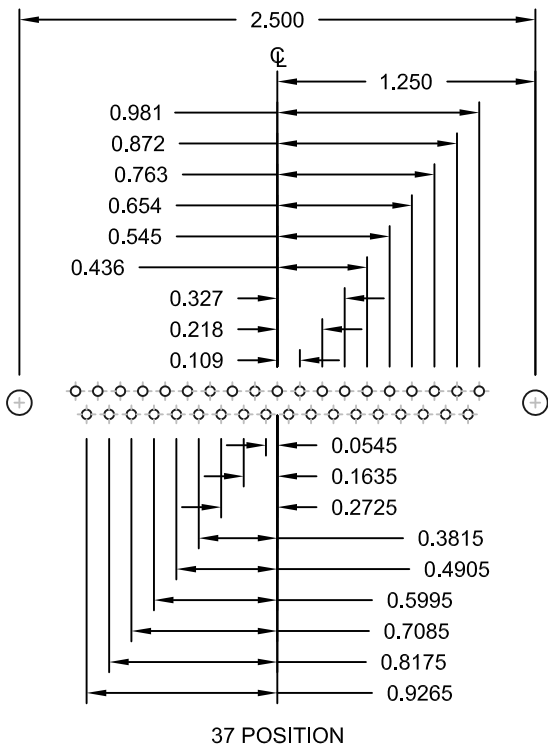
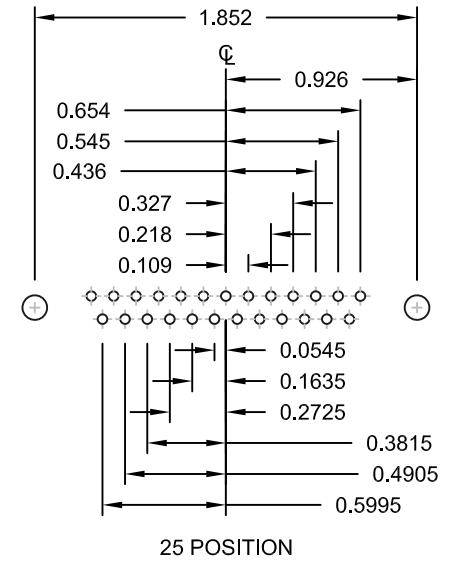
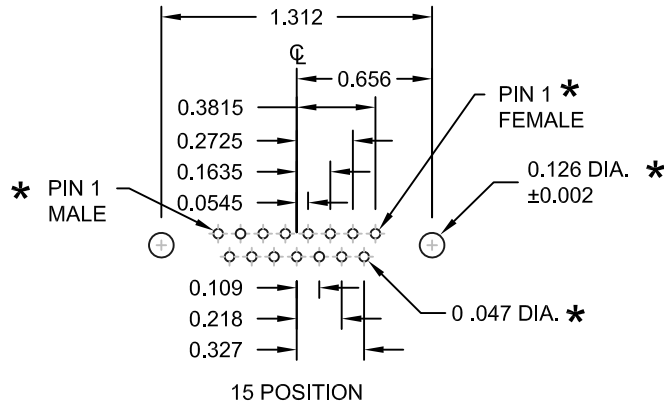
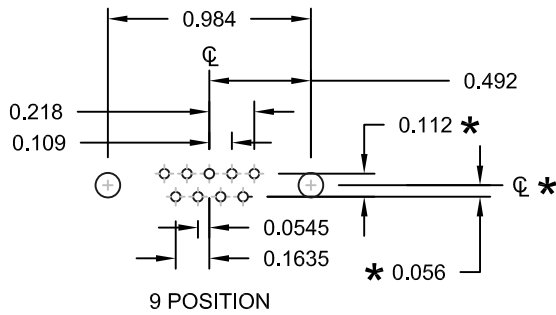

\* TYP. ON ALL SIZES

DO NOT SCALE FROM DRAWING

	THESE DRAWINGS AND SPECIFICATIONS ARE THE PROPERTY OF NorComp AND SHALL NOT BE REPRODUCED, COPIED OR USED AS THE BASIS FOR THE MANUFACTURE OF SALE OF APPARATUS WITHOUT WRITTEN PERMISSION.		DRAWN: <b>PAM JENKINS</b>	DATE: 09-12-05
	NorComp		SCALE: NTS	SHEET 2 OF 3
DWG NO. 172-YYY-212RYY1				

DESCRIPTION: CLINCH NUT HARDWARE

ALL CLINCH-NUTS ARE 4-40 INTERNAL THREADS

TOLERANCE:  
ALL DIMENSIONS ARE ±0.010

01X ..... 0.065" (BOARD SIDE) - CN1

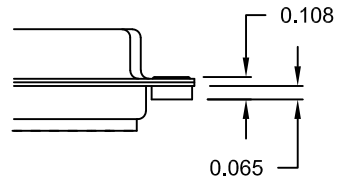

02X ..... 0.250" (BOARD SIDE) - CN2

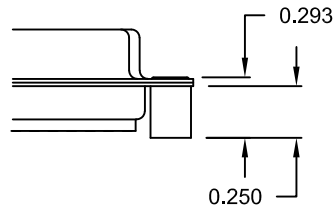

03X..... 0.250" (MATING SIDE) - CN8

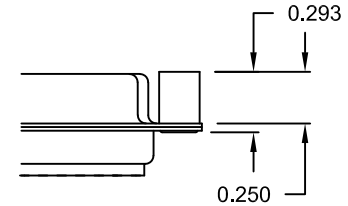

05X ..... 0.237" (BOARD SIDE) - CN10

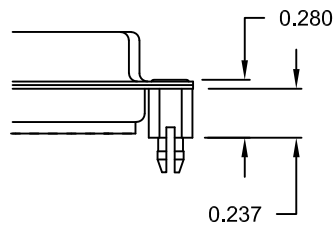

91X ..... 0.237" (BOARD SIDE) - 0.197 MATING SIDE - CN10/SFISO4404

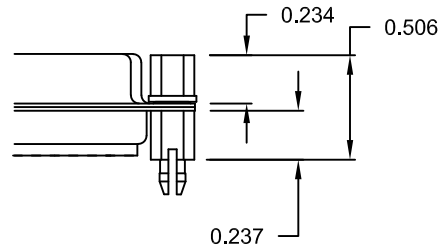

NOTE: 4-40 FEMALE SCREW LOCK IS REMOVABLE

90X ..... 0.237" (BOARD SIDE) - CN10-237-093

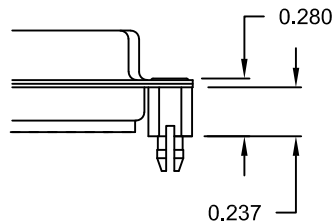

92X ..... 0.237" BOARD SIDE  
0.197 MATING SIDE  
CN10-237-093/SFISO4404

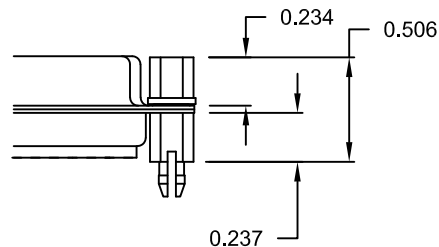

NOTE: 4-40 FEMALE SCREW LOCK IS REMOVABLE

NOTE: 90 & 92 OPTION FOR 0.093" MAX. BOARD THICKNESS

DO NOT SCALE FROM DRAWING



THESE DRAWINGS AND SPECIFICATIONS ARE THE PROPERTY OF NorComp AND SHALL NOT BE REPRODUCED, COPIED OR USED AS THE BASIS FOR THE MANUFACTURE OF SALE OF APPARATUS WITHOUT WRITTEN PERMISSION.

DRAWN: PAM JENKINS		DATE: 09-12-05	
SCALE: NTS	SHEET 3	OF 3	REV 18
DWG NO. 172-YYY-212RYY1			

RoHS COMPLIANT

NorComp