

# Hermetic Infrared Emitting Diode

## OP230 Series



### Features:

- Focused and non-focused optical light pattern
- Enhanced temperature range
- TO-46 hermetically sealed package
- Mechanically and spectrally matched to other Optek devices
- Choice of power ranges
- Choice of narrow or wide irradiance pattern



### Description:

Each device in this series is a gallium aluminum arsenide (GaAlAs) infrared emitting diode, mounted in a hermetic metal TO-46 housing. The gallium aluminum arsenide feature provides a higher radiated output than gallium arsenide at the same forward current.

Each **OP231**, **OP232**, **OP233**, **OP234** and **OP235** device is lensed to provide a narrow beam angle (18°) between half power points. The 890 nm wavelength closely matches the spectral response of silicon phototransistors, while the narrow beam angle – combined with the specified radiant intensity of the OP231 series – facilitates easy design in beam interrupt applications in conjunction with the OP800 or OP598 series photosensors. *The OP231 series is mechanically and spectrally matched to OP800, OP593 and OP598 phototransistors.*

Each **OP231W**, **OP232W**, **OP233W**, **OP234W** and **OP235W** device is lensed to provide a wide beam angle (50°) between half power points. The 890 nm wavelength closely matches the spectral response of silicon photo-transistors, while the wide beam angle provides relatively even illumination over a large area. *The OP231W is mechanically and spectrally matched to the OP800WSL and OP830SL series devices.*

Please refer to Application Bulletins 208 and 210 for additional design information and reliability (degradation) data.

Custom electrical, wire and cabling and connectors are available. Contact your local representative or OPTEK for more information.

### Applications:

- Non-contact reflective object sensor
- Assembly line automation
- Machine automation
- Machine safety
- End of travel sensor
- Door sensor

Ordering Information				
Part Number	LED Peak Wavelength	Output Power (mW/cm <sup>2</sup> ) Min / Max	Total Beam Angle	Lead Length
<b>OP231</b>	890 nm	1.5 / NA	18°	0.50"
<b>OP232</b>		2.0 / 6.0		
<b>OP233</b>		3.0 / NA		
<b>OP234</b>		5.0 / NA		
<b>OP235</b>		6.0 / NA		
<b>OP231W</b>	890 nm	1.5 / NA	50°	
<b>OP232W</b>		3.5 / 7.0		
<b>OP233W</b>		5.0 / NA		
<b>OP234W</b>		5.0 / NA		
<b>OP235W</b>	850 nm	6.0 / NA		

### General Note

TT Electronics reserves the right to make changes in product specification without notice or liability. All information is subject to TT Electronics' own data and is considered accurate at time of going to print.

OPTEK Technology, Inc.  
1645 Wallace Drive, Carrollton, TX 75006 | Ph: +1 972 323 2200  
www.optekinc.com | www.ttelectronics.com

# Hermetic Infrared Emitting Diode

## OP230 Series



### OP231, OP232, OP233, OP234, OP235

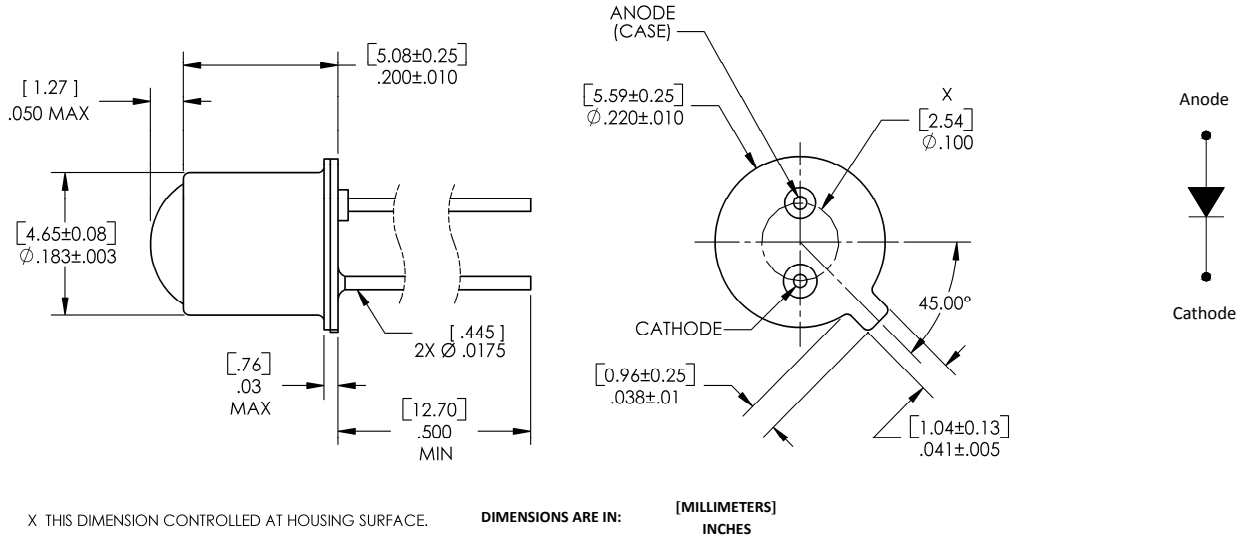

### OP231W, OP232W, OP233W, OP234W, OP235W

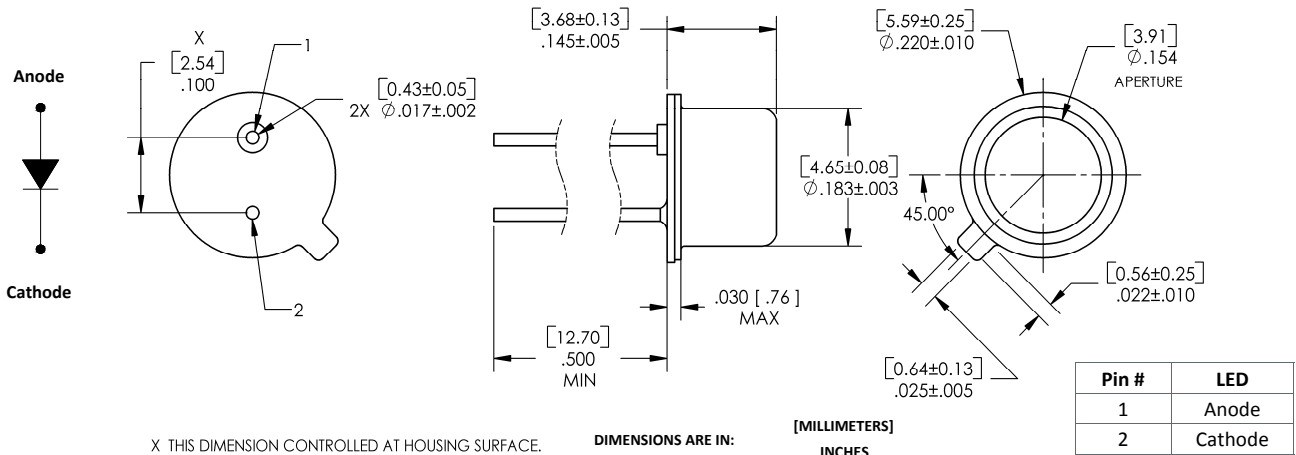

### Absolute Maximum Ratings (T<sub>A</sub>=25°C unless otherwise noted)

Storage Temperature Range	-65° C to +150° C
Operating Temperature Range	-65° C to +125° C
Reverse Voltage	2.0 A
Continuous Forward Current	100 mA
Peak Forward Current	10.0 A
Lead Soldering Temperature [1/16 inch (1.6 mm) from case for 5 seconds with soldering iron]	260° C <sup>(1)(2)</sup>
Power Dissipation	200 mW <sup>(3)</sup>

General Note  
 TT Electronics reserves the right to make changes in product specification without notice or liability. All information is subject to TT Electronics' own data and is considered accurate at time of going to print.

OPTEK Technology, Inc.  
 1645 Wallace Drive, Carrollton, TX 75006 | Ph: +1 972 323 2200  
[www.optekinc.com](http://www.optekinc.com) | [www.ttelectronics.com](http://www.ttelectronics.com)

# Hermetic Infrared Emitting Diode

## OP230 Series



### Electrical Characteristics ( $T_A = 25^\circ\text{C}$ unless otherwise noted)

SYMBOL	PARAMETER	MIN	TYP	MAX	UNITS	TEST CONDITIONS
--------	-----------	-----	-----	-----	-------	-----------------

#### Input Diode

$E_{E(APTa)}$	Apertured Radiant Incidence					
	OP231	1.5	-	-	mW/ cm <sup>2</sup>	OP231 Series $I_F = 100\text{ mA}^{(3)(4)}$ Aperture = 0.250" Distance = 1.429"
	OP232	2.0	-	6.0		
	OP233	3.0	-	-		
	OP234	5.0	-	-		
	OP235	6.0	-	-		
	OP231W	1.5	-	-	mW/ cm <sup>2</sup>	OP231W Series $I_F = 100\text{ mA}^{(3)(4)}$ Aperture = 0.250" Distance = 0.466"
	OP232W	3.5	-	7.0		
	OP233W	5.0	-	-		
	OP234W	5.0	-	-		
OP235W	6.0	-	-			
$P_O$	Radiant Power Output				mW	$I_F = 100\text{ mA}^{(3)(4)}$
	OP231	-	6.0	-		
	OP232	-	8.0	-		
	OP233	-	10.0	-		
$V_F$	Forward Voltage	-	-	2.0	V	$I_F = 100\text{ mA}^{(3)}$
$I_R$	Reverse Current	-	-	100	$\mu\text{A}$	$V_R = 2.0\text{ V}$
$\lambda_P$	Wavelength at Peak Emission				nm	$I_F = 10\text{ mA}$
	OP231, OP232, OP233	-	890	-		
	OP234, OP235	-	850	-		
$\beta$	Spectral Bandwidth between Half Power Points	-	80	-	nm	$I_F = 10\text{ mA}$
$\Delta\lambda_P/\Delta T$	Spectral Shift with Temperature	-	+0.30	-	nm/ $^\circ\text{C}$	$I_F = \text{Constant}$
$\theta_{HP}$	Emission Angle at Half Power Points				Degree	$I_F = 100\text{ mA}$
	OP231 - OP235	-	18	-		
	OP231W - OP231W	-	50	-		
$t_r$	Output Rise Time	-	500	-	ns	$I_{F(PK)} = 100\text{ mA}$ , $PW = 10\text{ }\mu\text{s}$ , and D.C. = 10.0%
$t_f$	Output Fall Time	-	250	-	ns	

#### Notes:

1. RMA flux is recommended. Duration can be extended to 10 seconds maximum when flow soldering.
2. Derate linearly 2.0 mW/ $^\circ\text{C}$  above 25 $^\circ\text{C}$ .
3. Measurement made with 100  $\mu\text{s}$  pulse measured at the trailing edge of the pulse with a duty cycle of 0.1% and an  $I_F = 100\text{ mA}$ .
4. For the OP231 series,  $E_{E(APT)}$  is a measurement of the average radiant intensity within the cone formed by the measurement surface, a radius of 1.429" (36.30 mm) measured from the lens side of the tab to the sensing surface and a sensing surface of 0.250" (6.35 mm) in diameter forming a 10 $^\circ$  cone. For the OP231W series,  $E_{E(APT)}$  is a measurement of the average radiant intensity within the cone formed by the measurement surface, a radius of 0.466" (11.84 mm) measured from the lens side of the tab to the sensing surface and a sensing surface of 0.250" (6.35 mm) in diameter forming a 10 $^\circ$  cone.  $E_{E(APT)}$  is not necessarily uniform within the measured area.

#### General Note

TT Electronics reserves the right to make changes in product specification without notice or liability. All information is subject to TT Electronics' own data and is considered accurate at time of going to print.

OPTEK Technology, Inc.  
1645 Wallace Drive, Carrollton, TX 75006 | Ph: +1 972 323 2200  
www.optekinc.com | www.ttelectronics.com

# Hermetic Infrared Emitting Diode

## OP230 Series



OP231, OP232, OP233 (including "W" devices)

Forward Voltage vs Forward Current vs Temperature

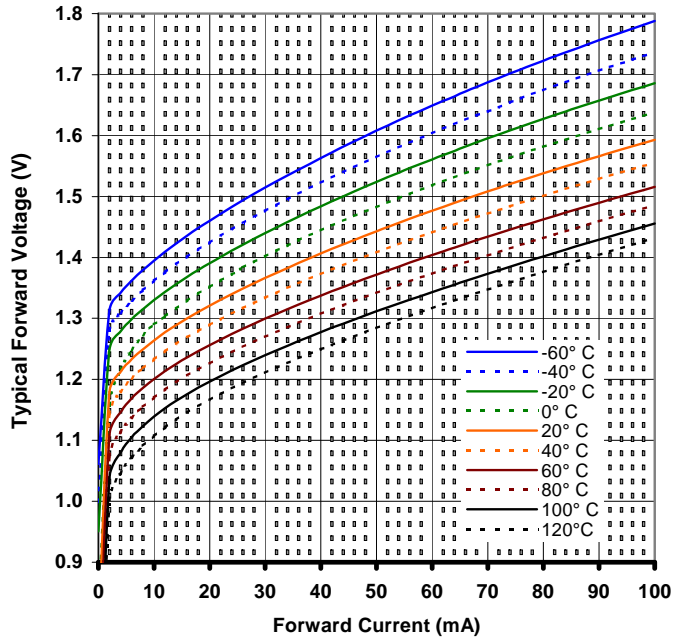

Optical Power vs  $I_F$  vs Temperature

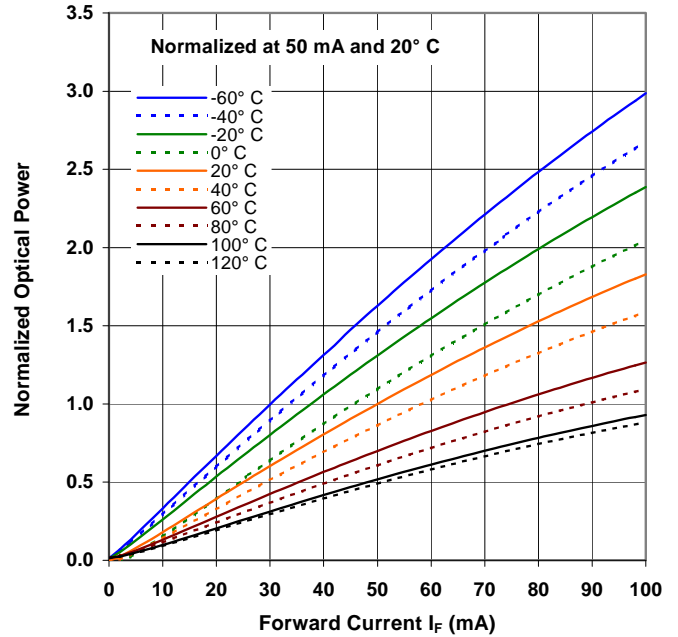

Distance vs Output Power vs Forward Current

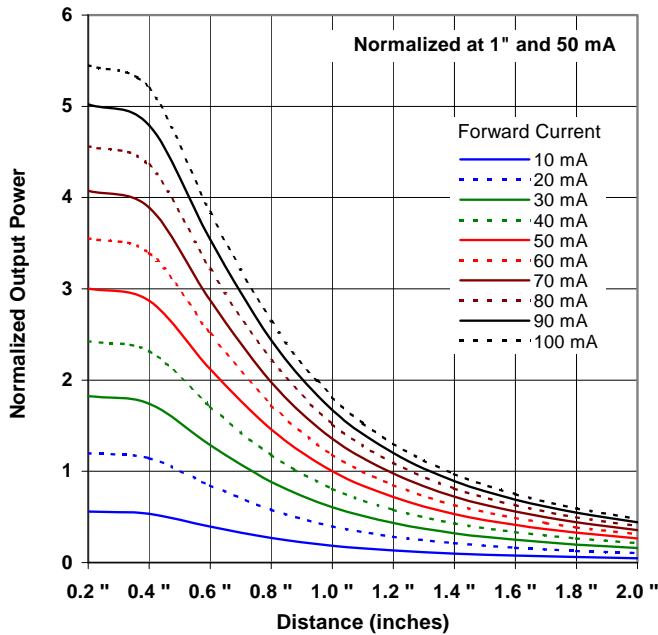

Relative Radiant Intensity vs. Angular Displacement

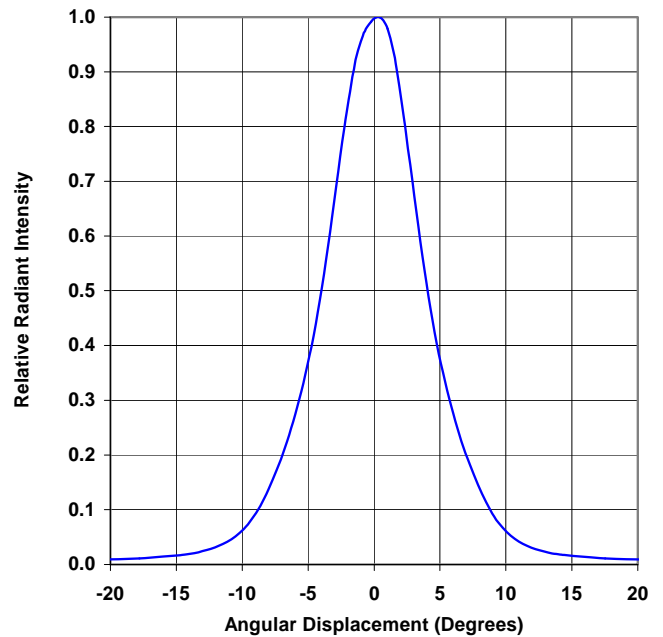

General Note  
 TT Electronics reserves the right to make changes in product specification without notice or liability. All information is subject to TT Electronics' own data and is considered accurate at time of going to print.

OPTEK Technology, Inc.  
 1645 Wallace Drive, Carrollton, TX 75006 | Ph: +1 972.323.2200  
[www.optekinc.com](http://www.optekinc.com) | [www.ttelectronics.com](http://www.ttelectronics.com)

# Hermetic Infrared Emitting Diode

## OP230 Series



### OP234, OP234W

Forward Voltage vs Forward Current vs Temperature

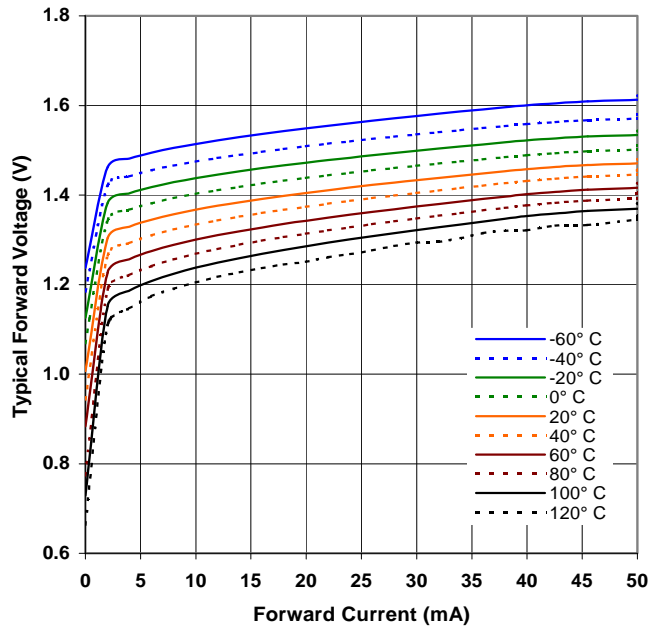

Optical Power vs Forward Current vs Temperature

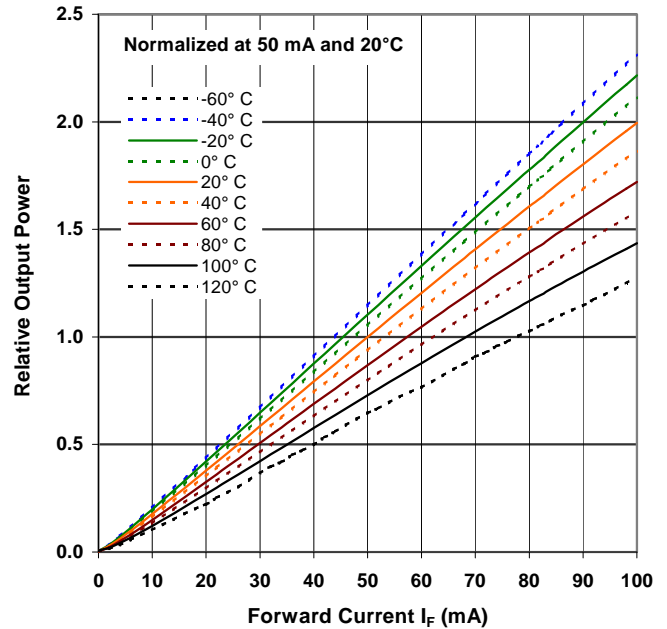

Distance vs Output Power vs Forward Current

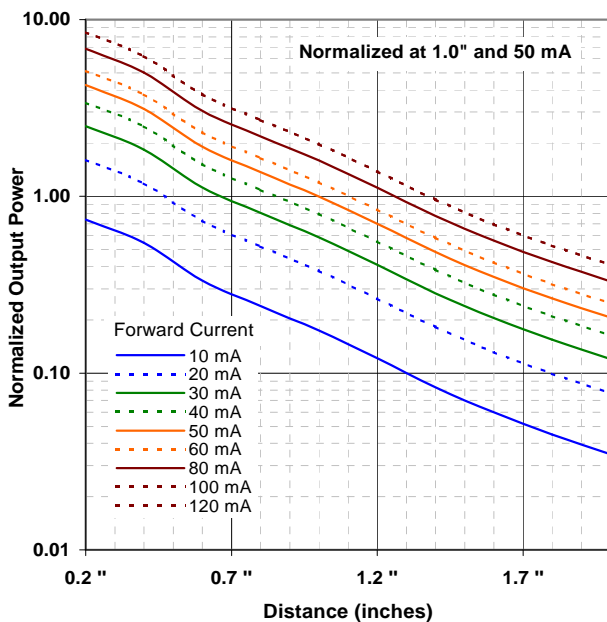

Relative Radiant Intensity vs Angular Displacement

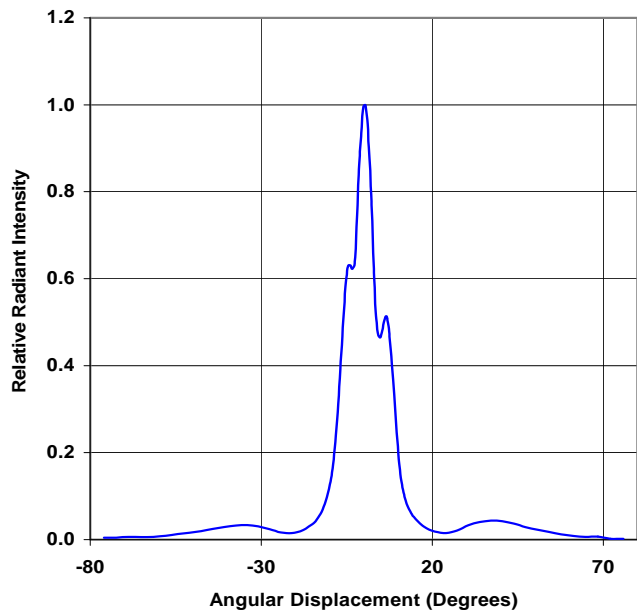

General Note  
 TT Electronics reserves the right to make changes in product specification without notice or liability. All information is subject to TT Electronics' own data and is considered accurate at time of going to print.

OPTEK Technology, Inc.  
 1645 Wallace Drive, Carrollton, TX 75006 | Ph: +1 972 323 2200  
[www.optekinc.com](http://www.optekinc.com) | [www.ttelectronics.com](http://www.ttelectronics.com)

# Hermetic Infrared Emitting Diode

## OP230 Series



### OP235, OP235W

Forward Voltage vs Forward Current vs Temperature

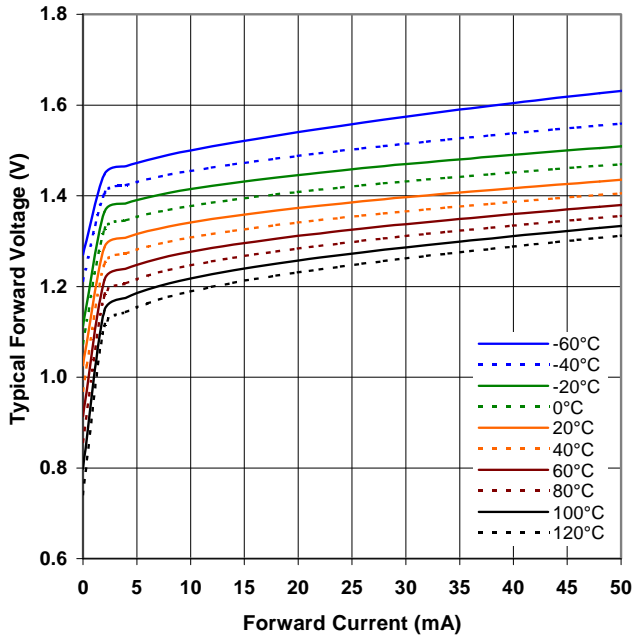

Optical Power vs Forward Current vs Temperature

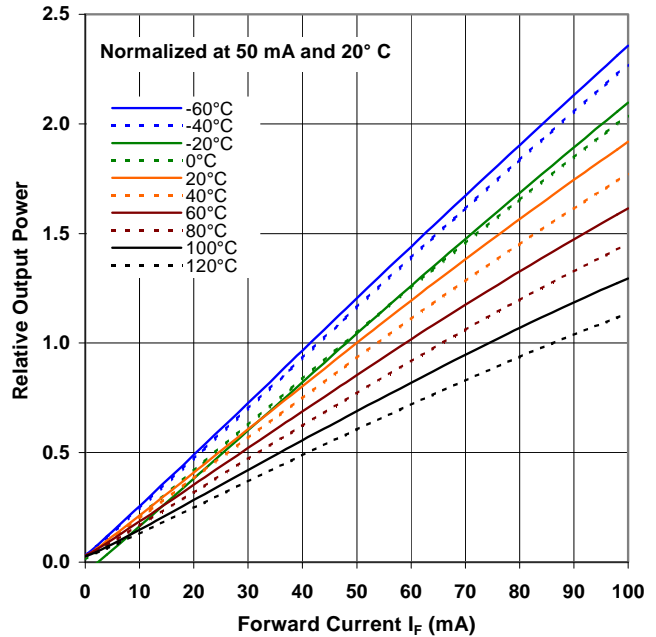

Distance vs Output Power vs Forward Current

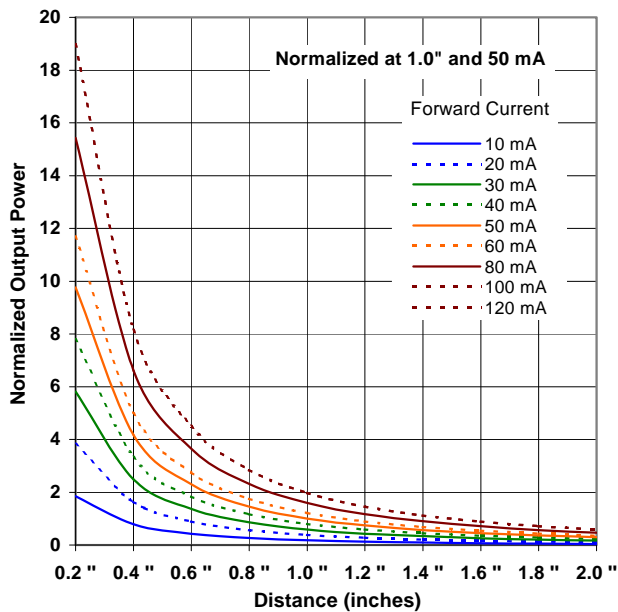

General Note  
 TT Electronics reserves the right to make changes in product specification without notice or liability. All information is subject to TT Electronics' own data and is considered accurate at time of going to print.

OPTEK Technology, Inc.  
 1645 Wallace Drive, Carrollton, TX 75006 | Ph: +1 972.323.2200  
[www.optekinc.com](http://www.optekinc.com) | [www.ttelectronics.com](http://www.ttelectronics.com)

# Mouser Electronics

Authorized Distributor

Click to View Pricing, Inventory, Delivery & Lifecycle Information:

[TT Electronics:](#)

[OP231](#) [OP231W](#) [OP232](#) [OP232W](#) [OP233](#) [OP233W](#) [OP234](#) [OP234W](#) [OP235](#) [OP235W](#)