

THIS DOCUMENT IS THE PROPERTY OF
KEYSTONE ELECTRONICS CORP. AND
SHALL NOT BE REPRODUCED, DISTRIBUTED
OR USED AS A BASIS FOR MANUFACTURE
WITHOUT PRIOR WRITTEN PERMISSION
FROM KEYSTONE ELECTRONICS CORP.

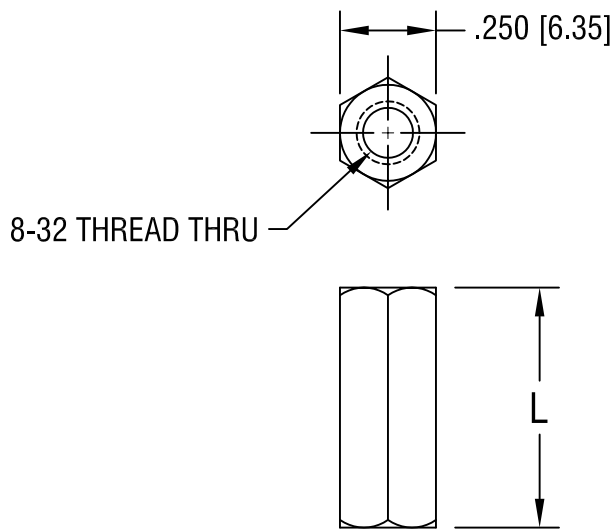

PART NO.	'L' DIM.
1827	.625 [15.88]
1828	.875 [22.23]

KEYSTONE ELECTRONICS CORP.			
ASTORIA, N.Y. 11105-2017			
PART NAME			
THREADED HEX STANDOFF			
MATERIAL			
ALUMINUM			
FINISH		DRN BY	DATE
CLEAR IRIDITE		BOONE	3.11.98
		APP'D	SCALE
		LN	2X
TOLERANCES	INCH [MM]	CODE	DWG NO.
DECIMAL	$\pm .005$ [± 0.15]	C/M	1827-1828
ANGULAR	$\pm 1^\circ$		
UNLESS OTHERWISE SPECIFIED			

DATE	DESCRIPTION	REV.

Mouser Electronics

Authorized Distributor

Click to View Pricing, Inventory, Delivery & Lifecycle Information:

[Keystone Electronics:](#)

[1828](#)