

- Generation V Technology
- Ultra Low On-Resistance
- Dual P Channel MOSFET
- Surface Mount
- Available in Tape & Reel
- Dynamic dv/dt Rating
- Fast Switching
- Lead-Free

HEXFET® Power MOSFET

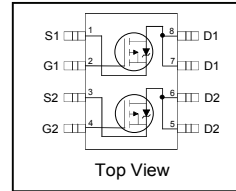

V_{DS}	-55V
$R_{DS(on)}$ max.	0.105Ω
I_D	-3.4A

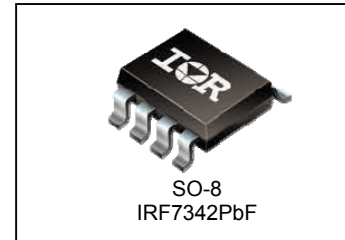

G	D	S
Gate	Drain	Source

Description

Fifth Generation HEXFETs from International Rectifier utilize advanced processing techniques to achieve extremely low on-resistance per silicon area. This benefit, combined with the fast switching speed and ruggedized device design that HEXFET Power MOSFETs are well known for, provides the designer with an extremely efficient and reliable device for use in a wide variety of applications.

The SO-8 has been modified through a customized lead frame for enhanced thermal characteristics and multiple-die capability making it ideal in a variety of power applications. With these improvements, multiple devices can be used in an application with dramatically reduced board space. The package is designed for vapor phase, infra red, or wave soldering techniques. Power dissipation of greater than 0.8W is possible in a typical PCB mount application.

Base part number	Package Type	Standard Pack		Orderable Part Number
		Form	Quantity	
IRF7342PbF	SO-8	Tape and Reel	4000	IRF7342PbF

Absolute Maximum Ratings			
Symbol	Parameter	Max.	Units
V_{DS}	Drain-Source Voltage	-55	V
$I_D @ T_A = 25^\circ\text{C}$	Continuous Drain Current, $V_{GS} @ -10\text{V}$	-3.4	A
$I_D @ T_A = 70^\circ\text{C}$	Continuous Drain Current, $V_{GS} @ -10\text{V}$	-2.7	
I_{DM}	Pulsed Drain Current ①	-27	
$P_D @ T_A = 25^\circ\text{C}$	Maximum Power Dissipation	2.0	W
$P_D @ T_A = 70^\circ\text{C}$	Maximum Power Dissipation	1.3	
	Linear De rating Factor	0.016	mW/°C
V_{GS}	Gate-to-Source Voltage	± 20	V
V_{GSM}	Gate-to-Source Voltage Single Pulse $t_p < 10\mu\text{s}$	30	
E_{AS}	Single Pulse Avalanche Energy (Thermally Limited) ②	114	mJ
dv/dt	Peak Diode Recovery dv/dt ③	5.0	V/ns
T_J T_{STG}	Operating Junction and Storage Temperature Range	-55 to + 150	°C

Thermal Resistance

Symbol	Parameter	Typ.	Max.	Units
$R_{\theta JA}$	Junction-to-Ambient ④	—	62.5	°C/W

Electrical Characteristics @ T_J = 25°C (unless otherwise specified)

	Parameter	Min.	Typ.	Max.	Units	Conditions
V _{(BR)DSS}	Drain-to-Source Breakdown Voltage	-55	—	—	V	V _{GS} = 0V, I _D = -250μA
ΔV _{(BR)DSS} /ΔT _J	Breakdown Voltage Temp. Coefficient	—	-0.054	—	V/°C	Reference to 25°C, I _D = -1mA
R _{DS(on)}	Static Drain-to-Source On-Resistance	—	0.095	0.105	Ω	V _{GS} = -10V, I _D = -3.4A ④
		—	0.150	0.170		V _{GS} = -4.5V, I _D = -2.7A ④
V _{GS(th)}	Gate Threshold Voltage	-1.0	—	—	V	V _{DS} = V _{GS} , I _D = -250μA
g _{fs}	Forward Trans conductance	3.3	—	—	S	V _{DS} = -10V, I _D = -3.1A
I _{DSS}	Drain-to-Source Leakage Current	—	—	-2.0	μA	V _{DS} = -55V, V _{GS} = 0V
		—	—	-25		V _{DS} = -55V, V _{GS} = 0V, T _J = 55°C
I _{GSS}	Gate-to-Source Forward Leakage	—	—	-100	nA	V _{GS} = -20V
	Gate-to-Source Reverse Leakage	—	—	100		V _{GS} = 20V
Q _g	Total Gate Charge	—	26	38	nC	I _D = -3.1A
Q _{gs}	Gate-to-Source Charge	—	3.0	4.5		V _{DS} = -44V
Q _{gd}	Gate-to-Drain ('Miller') Charge	—	8.4	13		V _{GS} = -10V, See Fig.10 ④
t _{d(on)}	Turn-On Delay Time	—	14	22	ns	V _{DD} = -28V
t _r	Rise Time	—	10	15		I _D = -1.0A
t _{d(off)}	Turn-Off Delay Time	—	43	64		R _G = 6.0Ω
t _f	Fall Time	—	22	32		R _D = 16Ω ④
C _{iss}	Input Capacitance	—	690	—	pF	V _{GS} = 0V
C _{oss}	Output Capacitance	—	210	—		V _{DS} = -25V
C _{rss}	Reverse Transfer Capacitance	—	86	—		f = 1.0MHz, See Fig.9

Diode Characteristics

	Parameter	Min.	Typ.	Max.	Units	Conditions
I _S	Continuous Source Current (Body Diode)	—	—	-2.0	A	MOSFET symbol showing the integral reverse p-n junction diode. 
I _{SM}	Pulsed Source Current (Body Diode) ①	—	—	-27		
V _{SD}	Diode Forward Voltage	—	—	-1.2	V	T _J = 25°C, I _S = -2.0A, V _{GS} = 0V ④
t _{rr}	Reverse Recovery Time	—	54	80	ns	T _J = 25°C, I _F = -2.0A,
Q _{rr}	Reverse Recovery Charge	—	85	130	nC	di/dt = 100A/μs ④

Notes:

- ① Repetitive rating; pulse width limited by max. junction temperature. (See Fig. 11)
- ② Starting T_J = 25°C, L = 20mH, R_G = 25Ω, I_{AS} = -3.4A. (See Fig. 8)
- ③ I_{SD} ≤ -3.4A, di/dt ≤ 150A/μs, V_{DD} ≤ V_{(BR)DSS}, T_J ≤ 150°C.
- ④ Pulse width ≤ 300μs; duty cycle ≤ 2%.
- ⑤ When mounted on 1" square copper board, t ≤ 10sec.

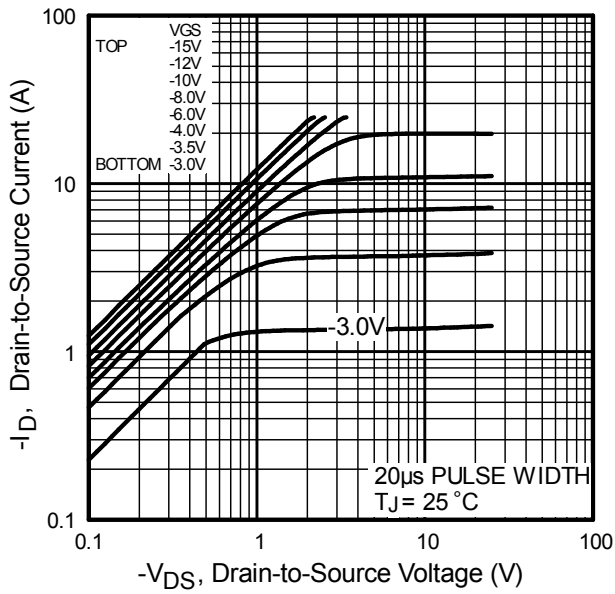
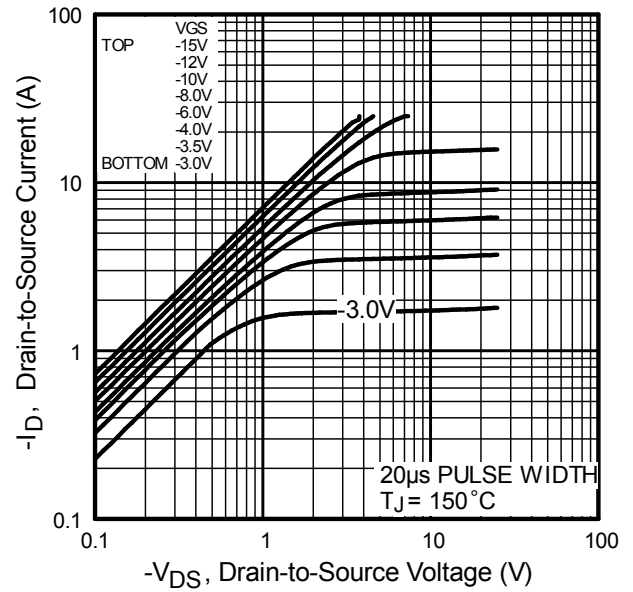
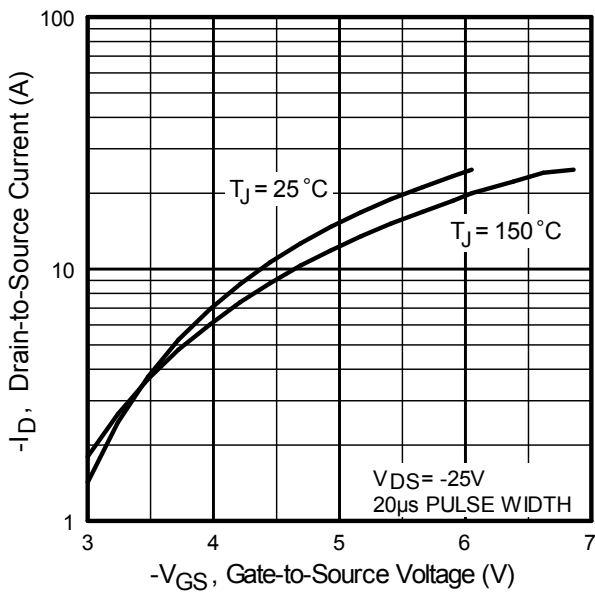
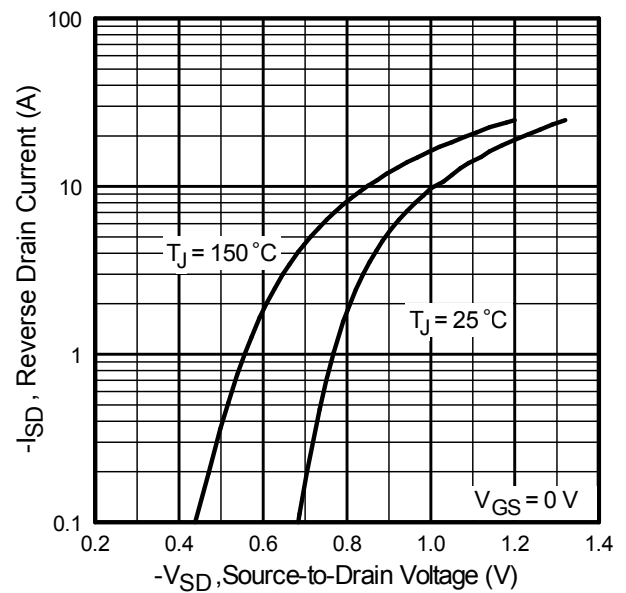
Fig. 1 Typical Output Characteristics

Fig. 2 Typical Output Characteristics

Fig. 3 Typical Transfer Characteristics

Fig. 4 Typical Source-Drain Diode Forward Voltage

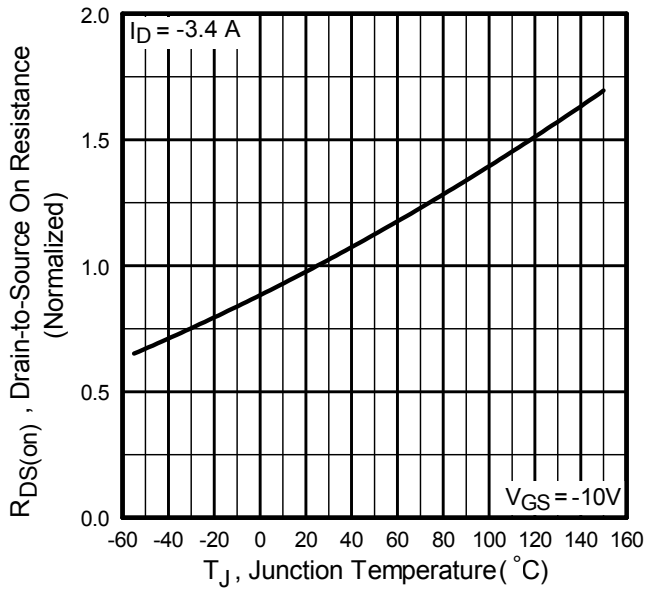

Fig 5. Normalized On-Resistance Vs. Temperature

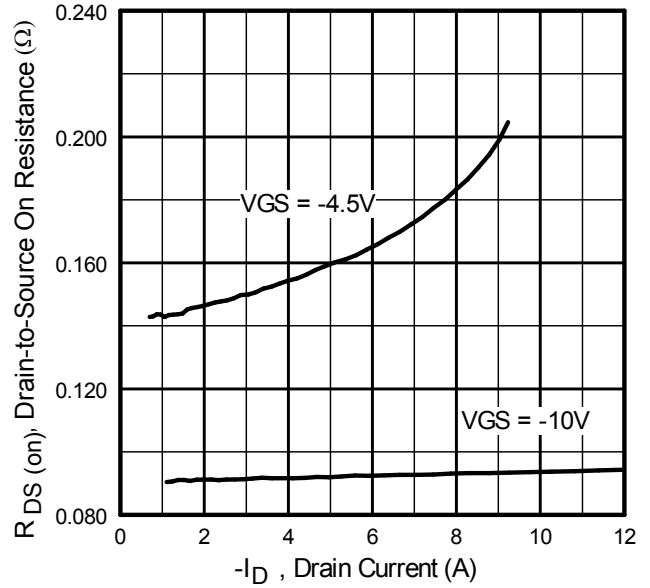

Fig 6. Typical On-Resistance Vs. Drain Current

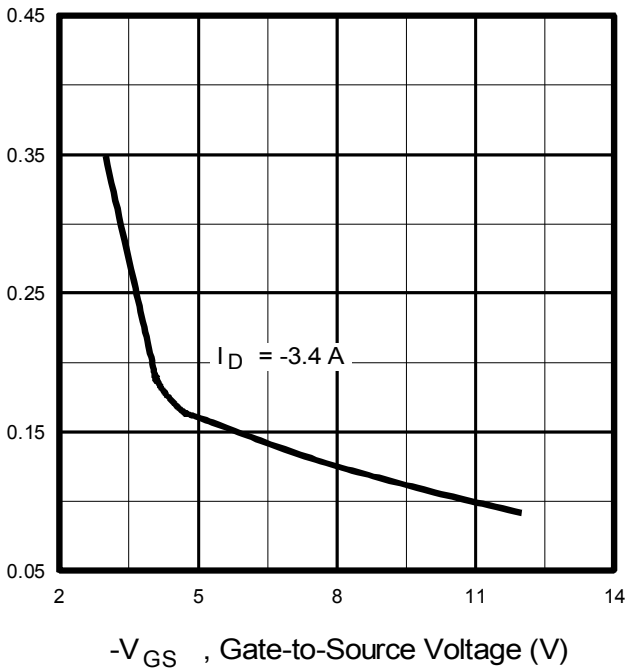

Fig 7. Typical On-Resistance Vs. Gate Voltage

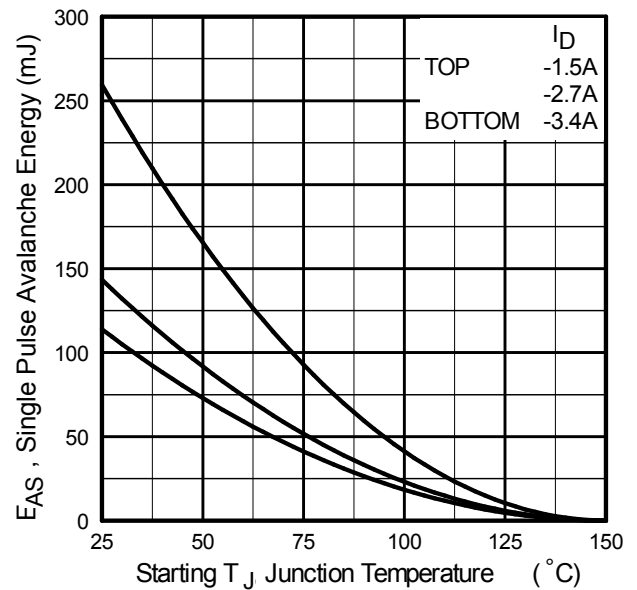

Fig 8. Maximum Avalanche Energy

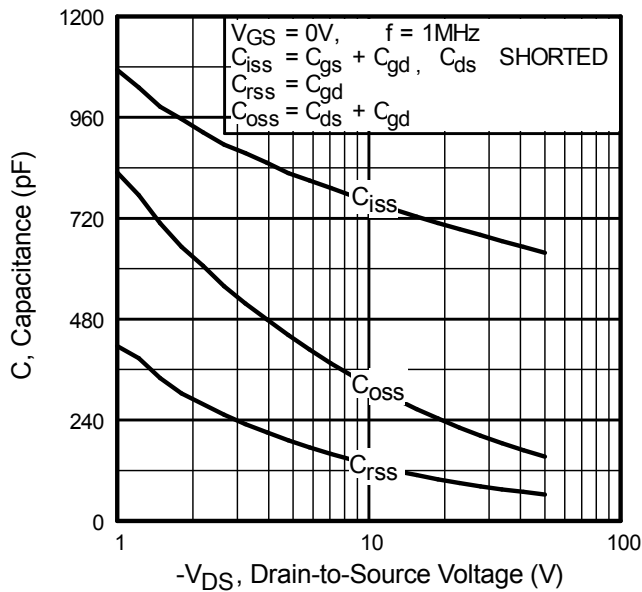

Fig 9. Typical Capacitance Vs. Drain-to-Source Voltage

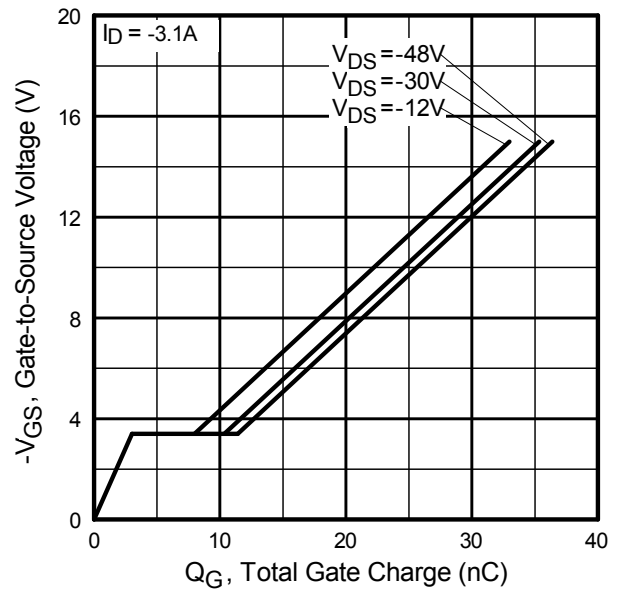

Fig 10. Typical Gate Charge Vs. Gate-to-Source Voltage

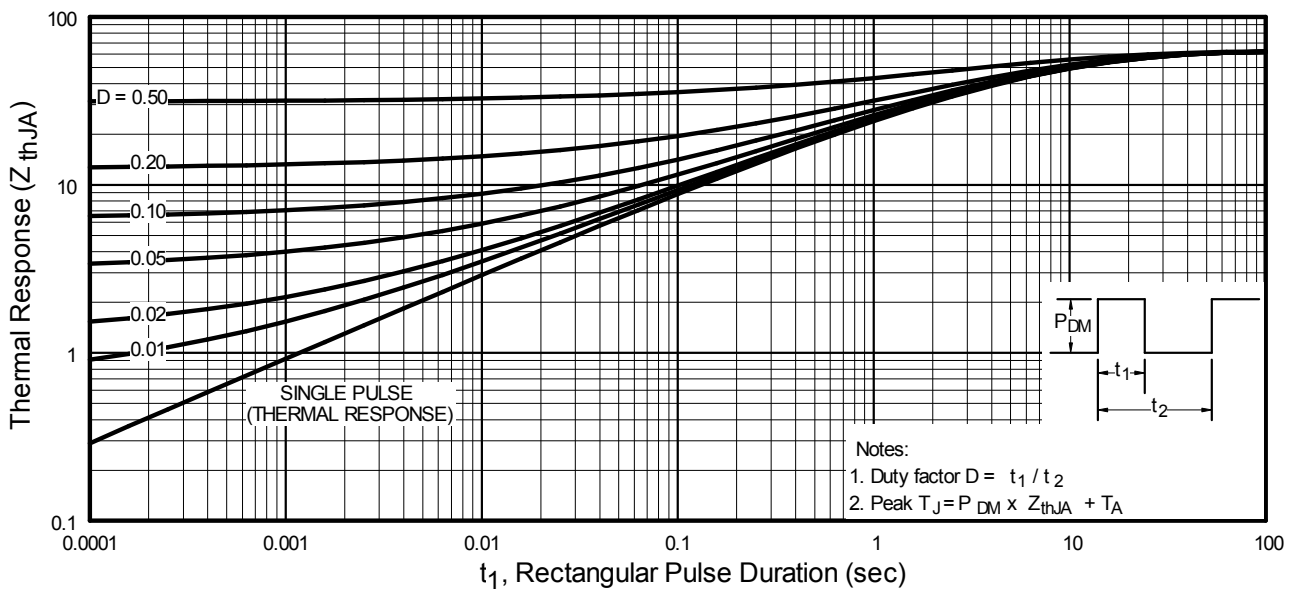
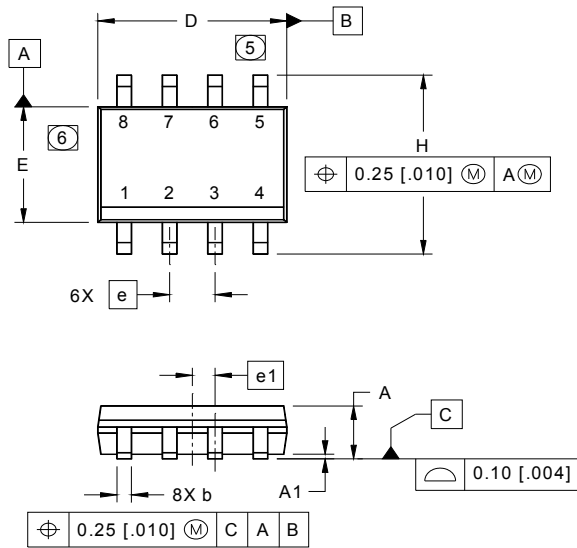
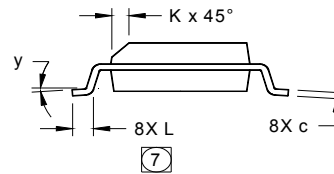

Fig 11. Maximum Effective Transient Thermal Impedance, Junction-to-Ambient

SO-8 Package Outline (Dimensions are shown in millimeters (inches))



DIM	INCHES		MILLIMETERS	
	MIN	MAX	MIN	MAX
A	.0532	.0688	1.35	1.75
A1	.0040	.0098	0.10	0.25
b	.013	.020	0.33	0.51
c	.0075	.0098	0.19	0.25
D	.189	.1968	4.80	5.00
E	.1497	.1574	3.80	4.00
e	.050 BASIC		1.27 BASIC	
e 1	.025 BASIC		0.635 BASIC	
H	.2284	.2440	5.80	6.20
K	.0099	.0196	0.25	0.50
L	.016	.050	0.40	1.27
y	0°	8°	0°	8°



- NOTES:
1. DIMENSIONING & TOLERANCING PER ASME Y14.5M-1994.
 2. CONTROLLING DIMENSION: MILLIMETER
 3. DIMENSIONS ARE SHOWN IN MILLIMETERS [INCHES].
 4. OUTLINE CONFORMS TO JEDEC OUTLINE MS-012AA.
 5. DIMENSION DOES NOT INCLUDE MOLD PROTRUSIONS. MOLD PROTRUSIONS NOT TO EXCEED 0.15 [0.006].
 6. DIMENSION DOES NOT INCLUDE MOLD PROTRUSIONS. MOLD PROTRUSIONS NOT TO EXCEED 0.25 [0.010].
 7. DIMENSION IS THE LENGTH OF LEAD FOR SOLDERING TO A SUBSTRATE.

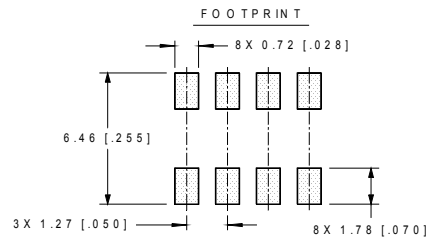

SO-8 Part Marking Information

EXAMPLE: THIS IS AN IRF7101 (MOSFET)

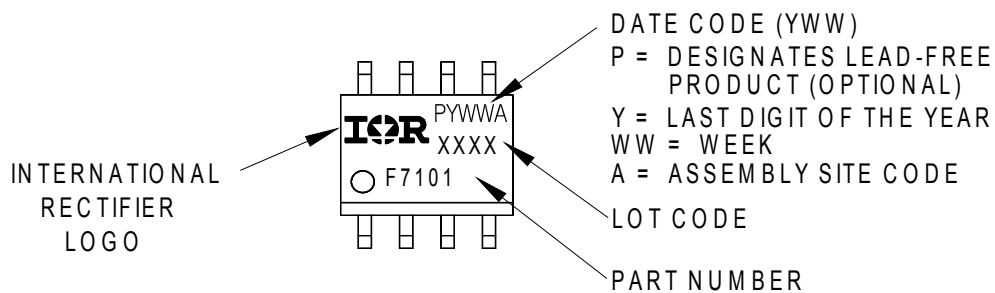

Note: For the most current drawing please refer to Infineon's web site www.infineon.com

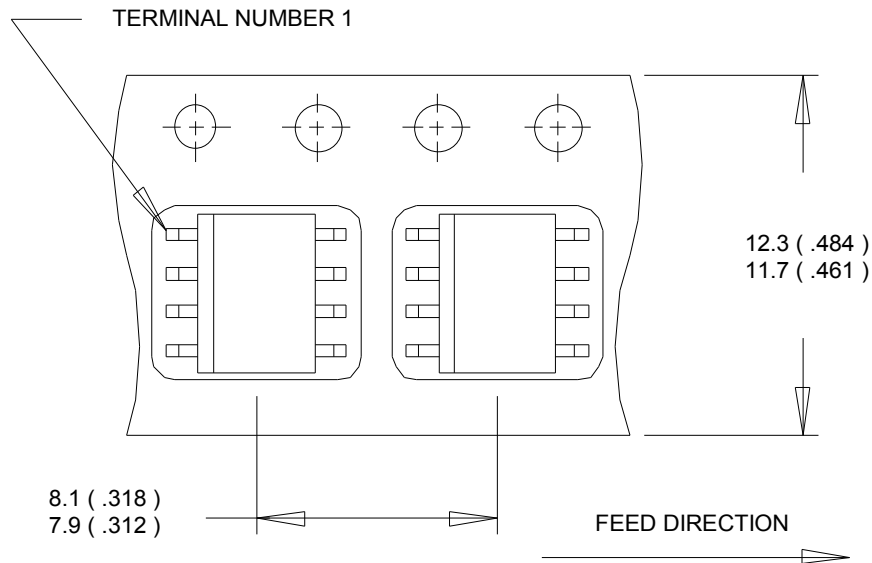
SO-8 Tape and Reel (Dimensions are shown in millimeters (inches))

NOTES:

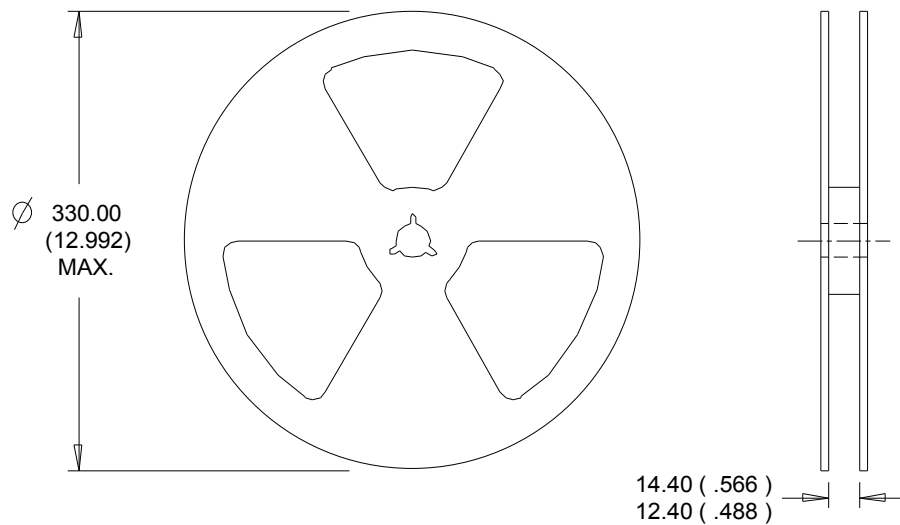
1. CONTROLLING DIMENSION : MILLIMETER.
2. ALL DIMENSIONS ARE SHOWN IN MILLIMETERS(INCHES).
3. OUTLINE CONFORMS TO EIA-481 & EIA-541.

NOTES :

1. CONTROLLING DIMENSION : MILLIMETER.
2. OUTLINE CONFORMS TO EIA-481 & EIA-541.

Note: For the most current drawing please refer to Infineon's web site www.infineon.com

Qualification Information†

Qualification Level	Consumer	
Moisture Sensitivity Level	SO-8	MSL1 (per JEDEC J-STD-020D) ^{††}
RoHS Compliant	Yes	

† Qualification standards can be found at Infineon’s web site www.infineon.com

†† Applicable version of JEDEC standard at the time of product release.

Revision History

Date	Comments
05/26/2016	<ul style="list-style-type: none"> Updated datasheet with corporate template Added disclaimer on last page.

Trademarks of Infineon Technologies AG

μHVIC™, μIPM™, μPFC™, AU-ConvertIR™, AURIX™, C166™, CanPAK™, CIPOS™, CIPURSE™, CoolDP™, CoolGaN™, COOLiR™, CoolMOS™, CoolSET™, CoolSiC™, DAVE™, DI-POL™, DirectFET™, DrBlade™, EasyPIM™, EconoBRIDGE™, EconoDUAL™, EconoPACK™, EconoPIM™, EiceDRIVER™, eupec™, FCOS™, GaNpowIR™, HEXFET™, HITFET™, HybridPACK™, iMOTION™, IRAM™, ISOFACE™, IsoPACK™, LEDriviR™, LITIX™, MIPAQ™, ModSTACK™, my-d™, NovalithIC™, OPTIGA™, OptiMOS™, ORIGA™, PowIRaudio™, PowIRStage™, PrimePACK™, PrimeSTACK™, PROFET™, PRO-SiL™, RASIC™, REAL3™, SmartLEWIS™, SOLID FLASH™, SPOC™, StrongIRFET™, SupIRBuck™, TEMPFET™, TRENCHSTOP™, TriCore™, UHVIC™, XHP™, XMC™

Trademarks updated November 2015

Other Trademarks

All referenced product or service names and trademarks are the property of their respective owners.

Edition 2016-04-19
Published by
Infineon Technologies AG
81726 Munich, Germany

© 2016 Infineon Technologies AG.
All Rights Reserved.

Do you have a question about this document?
Email: erratum@infineon.com

Document reference
ifx1

IMPORTANT NOTICE

The information given in this document shall in no event be regarded as a guarantee of conditions or characteristics (“**Beschaffungsgarantie**”).

With respect to any examples, hints or any typical values stated herein and/or any information regarding the application of the product, Infineon Technologies hereby disclaims any and all warranties and liabilities of any kind, including without limitation warranties of non-infringement of intellectual property rights of any third party.

In addition, any information given in this document is **subject to customer’s compliance with its obligations** stated in this document and any applicable legal requirements, norms and standards concerning customer’s products and any use of the product of Infineon Technologies in **customer’s applications**.

The data contained in this document is exclusively intended for technically trained staff. It is the **responsibility of customer’s technical departments** to evaluate the suitability of the product for the intended application and the completeness of the product information given in this document with respect to such application.

For further information on the product, technology, delivery terms and conditions and prices please contact your nearest Infineon Technologies office (www.infineon.com).

Please note that this product is not qualified according to the AEC Q100 or AEC Q101 documents of the Automotive Electronics Council.

WARNINGS

Due to technical requirements products may contain dangerous substances. For information on the types in question please contact your nearest Infineon Technologies office.

Except as otherwise explicitly approved by Infineon Technologies in a written document signed by authorized representatives of Infineon Technologies, **Infineon Technologies’ products may not be used** in any applications where a failure of the product or any consequences of the use thereof can reasonably be expected to result in personal injury.

Mouser Electronics

Authorized Distributor

Click to View Pricing, Inventory, Delivery & Lifecycle Information:

[Infineon:](#)

[IRF7342PBF](#) [IRF7342TRPBF](#)