

Typical unit

### FEATURES

- 600 KHz operation
- 4.5-14 Vdc input voltage range
- Programmable output voltage from 0.591-6.0 VDC
- Drives up to 200  $\mu$ F ceramic capacitive loads
- High power conversion efficiency at 93%
- Outstanding thermal derating performance
- Over temperature and over current protection
- On/Off control
- SIP, 0.41 x 0.65 x 0.4 inches (10.4 x 16.5 x 10.2 mm).
- Certified to UL/EN/IEC 60950-1 safety standards, 2nd edition
- RoHS-6 hazardous substance compliance

### PRODUCT OVERVIEW

The OKR-T/3 series are miniature SIP non-isolated Point-of-Load (PoL) DC/DC power converters measuring only 0.41 x 0.65 x 0.22 inches (10.4 x 16.5 x 5.6 mm). The wide input range is 4.5 to 14 Volts DC. Based on 600 KHz synchronous buck topology, the high power conversion efficient Point of Load (PoL) module features programmable output voltage and On/Off control, under voltage lock out (UVLO), overcurrent and over temperature protections. These units are certified to UL/EN/ IEC 60950-1 safety standards (2nd edition) and RoHS-6 hazardous substance compliance.

Figure 1. Connection Diagram

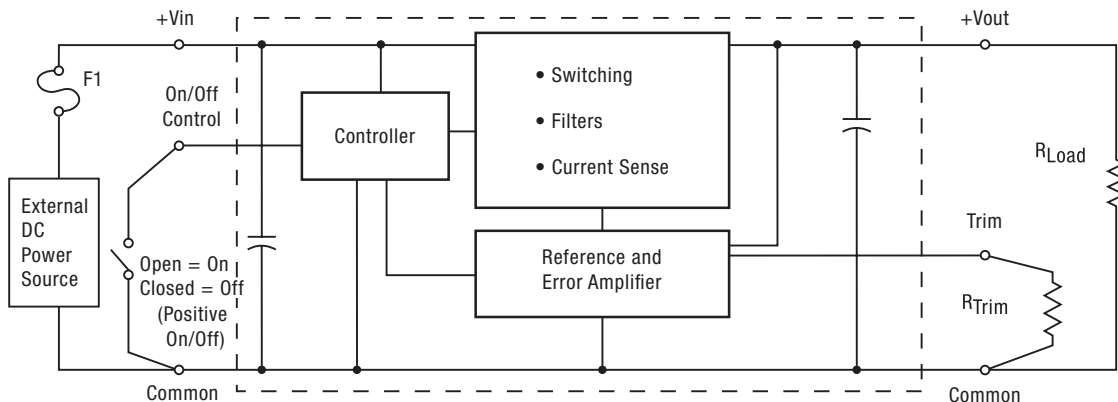

**Performance Specifications Summary and Ordering Guide**

ORDERING GUIDE														
Root Model	Output						Input				Efficiency		Package	
	V <sub>OUT</sub> (Volts)	I <sub>OUT</sub> (Amps max)	Power (Watts)	R/N (mVp-p)	Regulation (Max.)		V <sub>IN</sub> Nom. (Volts)	Range (Volts)	I <sub>IN</sub> , no load (mA)	I <sub>IN</sub> , full load (Amps)	Min.	Typ.	Case	Pinout
				Max.	Line	Load								
OKR-T/3-W12-C	0.591-6	3	15	25	±0.3%	±1.4%	12	4.5-14	80	1.34	90.75%	93%	C72	P73

- ① For V<sub>out</sub> ≥ 3.3V, V<sub>in</sub> should be ≥ (V<sub>out</sub> ÷ 0.85) + 0.5V.
- ② Ripple and Noise is shown at V<sub>out</sub>=1V. See specs for details.
- ③ All specifications are at nominal line voltage, V<sub>out</sub>=5V and full load, +25°C. unless other-

wise noted. Output capacitors are 1 μF ceramic and 22 μF electrolytic in parallel. Input cap is 22 μF. See detailed specifications. I/O caps are necessary for our test equipment and may not be needed for your application.

**PART NUMBER STRUCTURE**

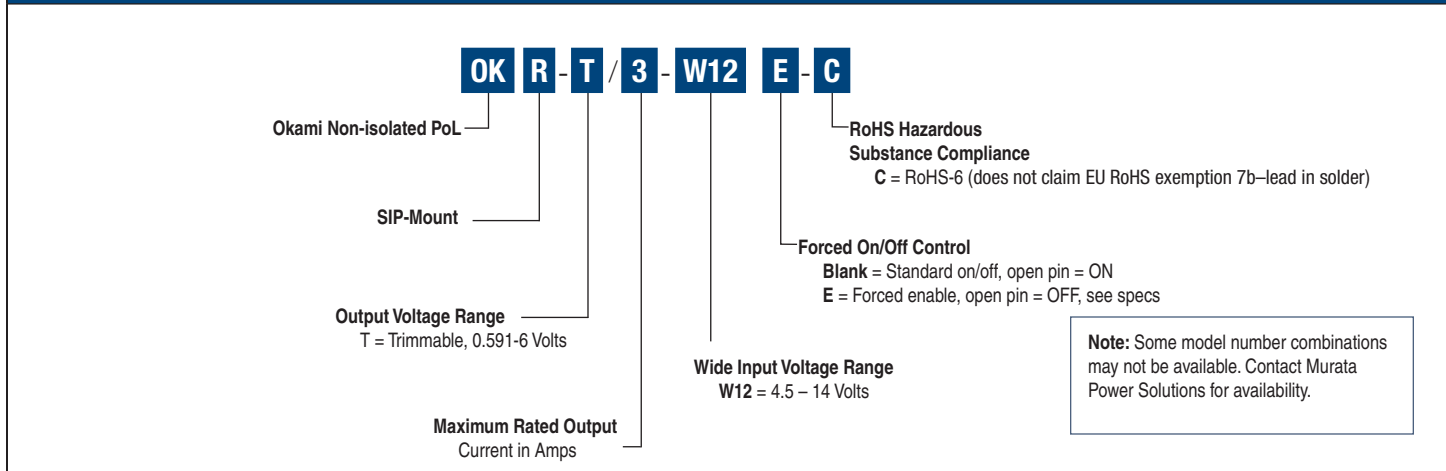

**Product Label**

Because of the small size of these products, the product label contains a character-reduced code to indicate the model number and manufacturing date code. Not all items on the label are always used. Please note that the label differs from the product photograph on page 1. Here is the layout of the label:

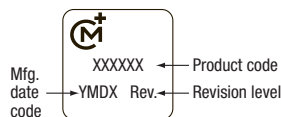

Figure 2. Label Artwork Layout

The label contains three rows of information:

- First row – Murata Power Solutions logo
- Second row – Model number product code (see table)
- Third row – Manufacturing date code and revision level

Model Number	Product Code
OKR-T/3-W12-C	R01103
OKR-T/3-W12E-C	R01103E

The manufacturing date code is four characters:

- First character – Last digit of manufacturing year, example 2009
- Second character – Month code (1 through 9 = Jan-Sep; 0, N, D = Oct, Nov, Dec)
- Third character – Day code (1 through 9 = 1 to 9, 10 = 0 and 11 through 31 = A through Z)
- Fourth character – Manufacturing information

**Performance/Functional Specifications**

All specifications are typical unless noted See Note 1.

Input	
<b>Input Voltage Range</b>	See Ordering Guide.
Recommended External Fuse	6 Amps
<b>Reverse Polarity Protection (Note 9)</b>	None. Use an external fuse.
<b>Isolation</b>	Not isolated. The input and output commons are internally connected.
<b>Start-Up Voltage</b>	4.2 Volts
<b>Undervoltage Shutdown</b>	3.4 Volts
<b>Reflected (Back) Ripple Current (Note 2)</b>	20 mA pk-pk
<b>Internal Input Filter Type</b>	Capacitive
<b>Input Current:</b>	
Full Load Conditions	See Ordering Guide
Inrush Transient	0.4 A <sup>2</sup> Sec.
Shutdown Mode (Off, UV, OT)	5 mA
Output Short Circuit	60 mA
No Load, 5V out	80 mA
Low Line (Vin=Vmin, 5Vout)	2.26 Amps
<b>Remote On/Off Control (Note 5)</b>	<b>[Standard version]</b>
<b>Positive Logic</b>	ON = +2 V. to +Vin max. or open pin OFF = -0.3 to +0.4 V. max. or ground pin
<b>Current</b>	1 mA
<b>Remote On/Off Control</b>	<b>[“E” version]</b>
<b>Positive Logic</b>	ON = +2 V. to +Vin max., 100KΩ pulldown to ground OFF = open pin or -0.3 to +0.4 V. max.
<b>Current</b>	1 mA max.
<b>Turn-on Time:</b>	
Vin on to Vout regulated	6 mSec
Remote On to Vout regulated	6 mSec
Output	
<b>Minimum Loading</b>	No minimum load
<b>Output Current Range</b> (to rated specifications)	0 to 3 Amps
<b>Accuracy (50% load, no trim)</b>	±2 % of Vnom
<b>Temperature Coefficient</b>	±0.02% per °C. of Vout range
<b>Ripple/Noise (20 MHz bandwidth)</b>	See Ordering Guide and note 14
<b>Line/Load Regulation</b>	See Ordering Guide and note 10
<b>Efficiency</b>	See Ordering Guide and performance graphs
<b>Maximum Capacitive Loading</b>	
Cap-ESR=0.001 to 0.015 Ohms	200 μF
Cap-ESR >0.015 Ohms	1000 μF
<b>Current Limit Inception</b> (98% of Vout setting, after warm up)	8 Amps
<b>Short Circuit Mode (Notes 6, 12)</b>	
Short Circuit Current Output	0.6 Amp
Protection Method removal. (Note 8)	Hiccup autorecovery upon overload
Short Circuit Duration (output shorted to ground)	Continuous, no damage
<b>Overvoltage protection</b>	None

Dynamic Characteristics	
<b>Dynamic Load Response (50 to 100% load step, no external caps)</b>	
di/dt = 1 A/μSec	20 μSec to within ±2% of final value
<b>Switching Frequency</b>	600 KHz
Environmental	
<b>Calculated MTBF (Note 4)</b>	
OKR-T/3-W12-C	12,230,400 hours (4a)
OKR-T/3-W12-C	5,273,231 hours (4b)
<b>Operating Temperature Range</b> (Ambient temp., Vout=5 V., vertical mount)	
Full power, see derating curves	-40 to +85 °C.
<b>Operating PC Board Range, no derating</b>	
	-40 to +100 °C.
<b>Storage Temperature Range</b>	
	-55 to +125 °C.
<b>Thermal Protection/Shutdown</b>	
	+130 °C.
<b>Relative Humidity</b>	
	to 85%/+85 °C.
<b>Restriction of Hazardous Substances</b>	
	RoHS-6 (does not claim EU RoHS exemption 7b-lead in solder)
Physical	
<b>Outline Dimensions</b>	See Mechanical Specifications
<b>Weight</b>	0.07 ounces (2 grams)
<b>Safety</b>	
	Certified to UL/cUL 60950-1 CSA-C22.2 No. 60950-1 IEC/EN 60950-1, 2nd edition
Absolute Maximum Ratings	
<b>Input Voltage</b>	
Continuous or transient	15 Volts max.
<b>Output Power</b>	
	15 Watts max.
<b>On/Off Control</b>	
	0 Volts. min. to +Vin. max.
<b>Input Reverse Polarity Protection</b>	
	See Fuse section
<b>Output Current</b>	
	Current-limited. Devices can withstand sustained short circuit without damage.
<b>Storage Temperature</b>	
	-40 to +125 deg. C.

Absolute maximums are stress ratings. Exposure of devices to greater than any of these conditions may adversely affect long-term reliability. Proper operation under conditions other than those listed in the Performance/Functional Specifications Table is not implied or recommended.

CAUTION: This product is not internally fused. To comply with safety agency certifications and to avoid injury to personnel or equipment, the user **must** supply an external fast-blow fuse to the input terminals.

**Notes**

- (1) All specifications are typical unless noted. General conditions for Specifications are +25 deg.C, Vin=nominal, Vout=nominal (no trim installed), full rated load. Adequate airflow must be supplied for extended testing under power.  
All models are tested and specified with external 1µF and 22 µF paralleled output capacitors and a 22 µF external input capacitor. All capacitors are low ESR types. Caps are layout dependent. These capacitors are necessary to accommodate our test equipment and may not be required in your applications. All models are stable and regulate within spec under no-load conditions.
- (2) Input Back Ripple Current is tested and specified over a 5 Hz to 20 MHz bandwidth. Input filtering is Cin=2 x 100 µF, 100V tantalum, Cbus=1000 µF, 100V electrolytic, Lbus=1 µH. All caps are low ESR types.
- (3) Note that Maximum Power Derating curves indicate an average current at nominal input voltage. At higher temperatures and/or lower airflow, the DC/DC converter will tolerate brief full current outputs if the total RMS current over time does not exceed the Derating curve. All Derating curves are presented at sea level altitude. Be aware of reduced power dissipation with increasing altitude.
- (4a) Mean Time Before Failure is calculated using the Telcordia (Belcore) SR-332 Method 1, Case 3, ground fixed conditions, Tpcboard=+25 °C, full output load, natural air convection.
- (4b) Mean Time Before Failure is calculated using the MIL-HDBK-217N2 method, ground benign, +25°C., full output load, natural convection.
- (5) The On/Off Control is normally controlled by a switch or open collector or open drain transistor. But it may also be driven with external logic or by applying appropriate external voltages which are referenced to Input Common.
- (6) Short circuit shutdown begins when the output voltage degrades approximately 2% from the selected setting.
- (7) The outputs are not intended to sink appreciable reverse current.
- (8) “Hiccup” overcurrent operation repeatedly attempts to restart the converter with a brief, full-current output. If the overcurrent condition still exists, the restart current will be removed and then tried again. This short current pulse prevents overheating and damaging the converter. Once the fault is removed, the converter immediately recovers normal operation.
- (9) Input Fusing: If reverse polarity is accidentally applied to the input, to ensure reverse input protection with full output load, always connect an external input fast-blow fuse in series with the +Vin input. Use approximately twice the full input current rating with nominal input voltage.
- (10) Regulation specifications describe the deviation as the line input voltage or output load current is varied from a nominal midpoint value to either extreme.
- (11) CAUTION: Since the converter is mounted on the end by its pins, do not subject it to high vibration, shock or acceleration.
- (12) Output current limit and short circuit protection is non-latching. When the overcurrent fault is removed, the converter will immediately recover.
- (13) Do not exceed maximum power specifications when adjusting the output trim. All published specifications are listed at rated nominal output current using published Derating curves. The maximum power specifications indicate brief operation before overcurrent shutdown occurs. Note particularly that current must be limited at higher output voltage in order to comply with maximum power requirements.
- (14) At zero output current, the output may contain low frequency components which exceed the ripple specification. The output may be operated indefinitely with no load.
- (15) The input and output are not isolated. They share a single COMMON power and signal return.

**Trim Connections**

**Output Voltage Adjustment**

The output voltage may be adjusted over a limited range by connecting an external trim resistor (Rtrim) between the Trim pin and Ground. The Rtrim resistor must be a 1/10 Watt precision metal film type, ±0.5% accuracy or better with low temperature coefficient, ±100 ppm/oC. or better. Mount the resistor close to the converter with very short leads or use a surface mount trim resistor.

In the tables below, the calculated resistance is given. Do not exceed the specified limits of the output voltage or the converter’s maximum power rating when applying these resistors. Also, avoid high noise at the Trim input. However, to prevent instability, you should never connect any capacitors to Trim.

**OKR-T/3-W12**

Output Voltage	Calculated Rtrim (Ω)
6 V.	218.5
5 V.	268
3.3 V.	436
2.5 V.	619
1.8 V.	978
1.5 V.	1300
1.2 V.	1940
1.0 V.	2890
0.591 V.	∞ (open)

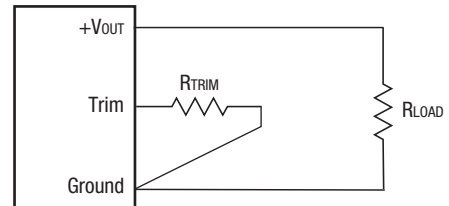

$$R_{TRIM} (k\Omega) = \frac{1.182}{V_{OUT} - 0.591}$$

**Resistor Trim Equation, OKR-T/3-W12 models:**

$$R_{TRIM} (k\Omega) = \frac{1.182}{(V_{OUT} - 0.591)}$$

**OKR-T/3-W12-C PERFORMANCE DATA**

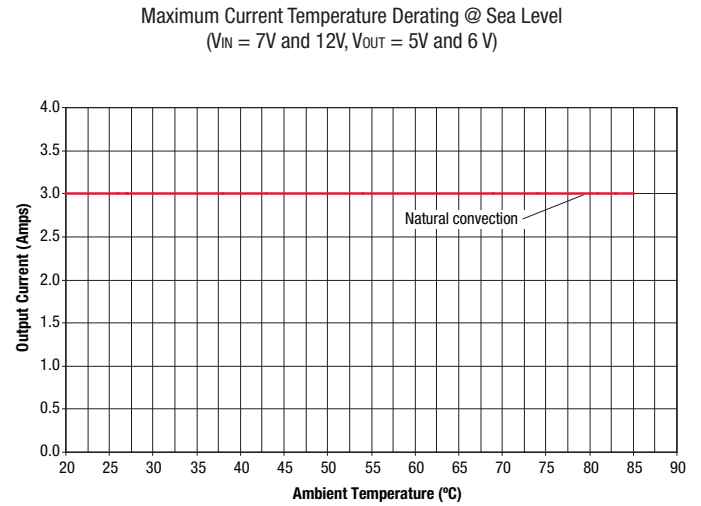
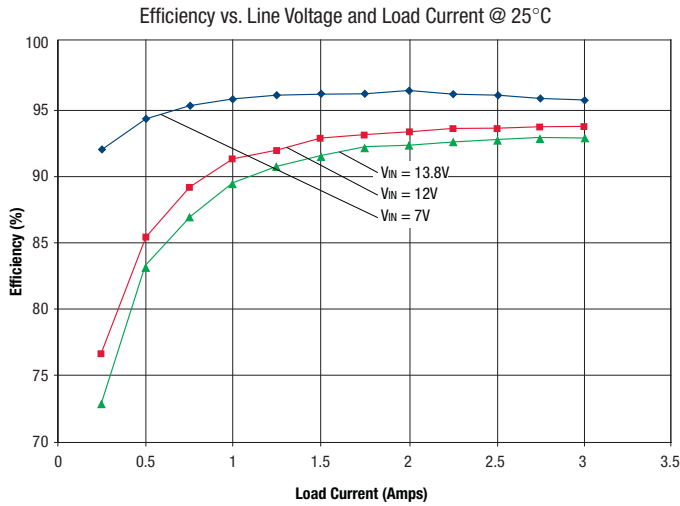

There is no derating for  $V_{out} = 0.591V$  to  $5.5V$  at full load.

**OKR-T/3-W12-C OSCILLOGRAMS –  $V_{out} = 1V$**

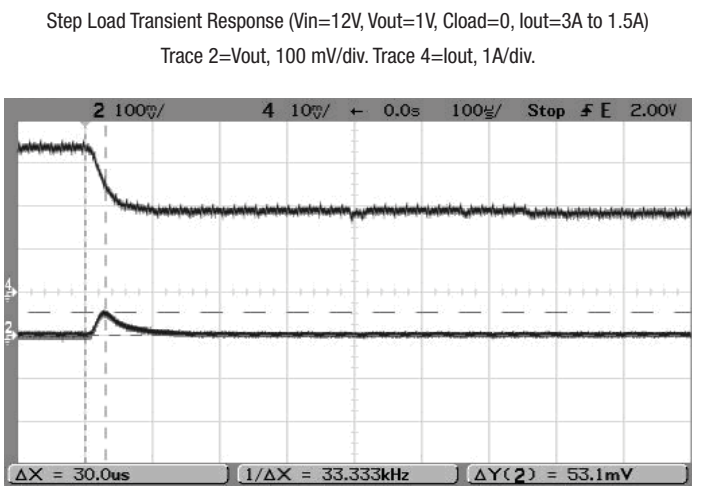
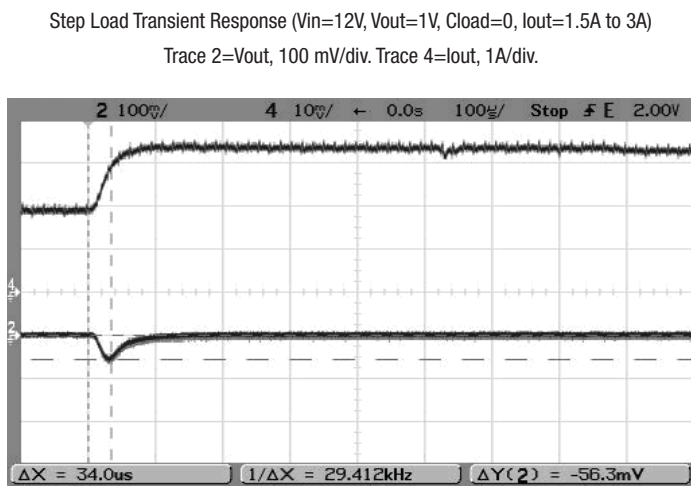
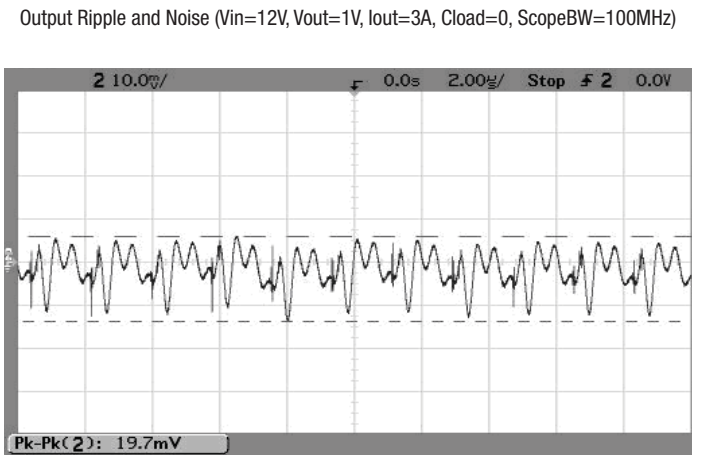
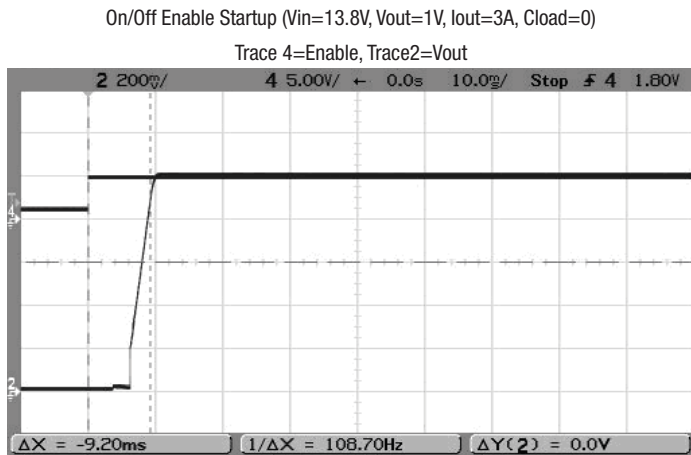

**OKR-T/3-W12-C OSCILLOGRAMS – Vout = 2.5V**

On/Off Enable Startup (Vin=13.8V, Vout=2.5V, Iout=3A, Cload=0)  
Trace 4=Enable, Trace 2=Vout

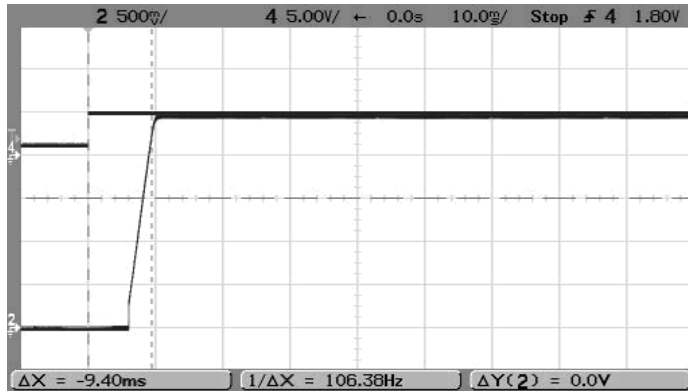

Output Ripple and Noise (Vin=12V, Vout=2.5V, Iout=3A, Cload=0, ScopeBW=100MHz)

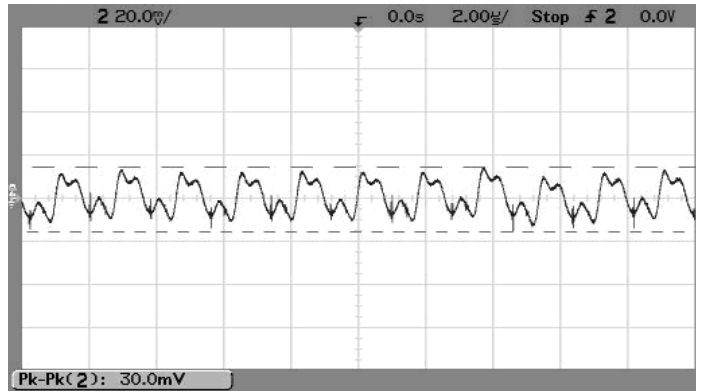

Step Load Transient Response (Vin=12V, Vout=2.5V, Cload=0, Iout=1.5A to 3A)  
Trace 2=Vout, 100 mV/div. Trace 4=Iout, 1A/div.

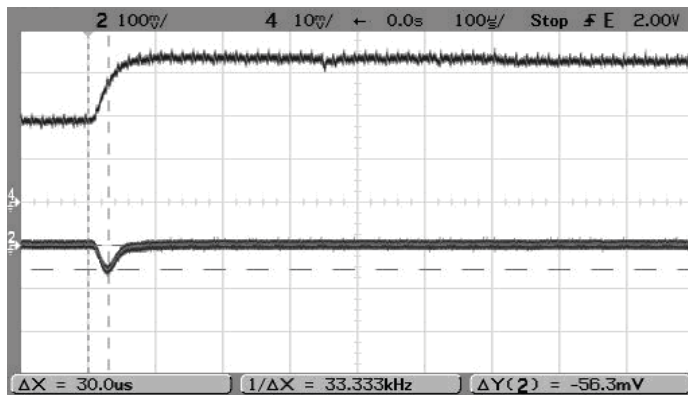

Step Load Transient Response (Vin=12V, Vout=2.5V, Cload=0, Iout=3A to 1.5A)  
Trace 2=Vout, 100 mV/div. Trace 4=Iout, 1A/div.

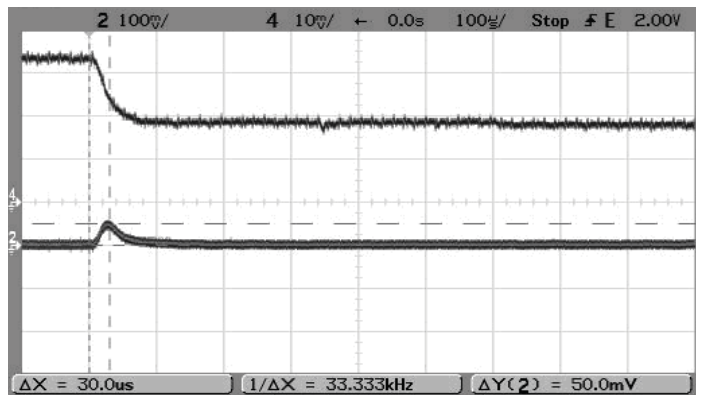

**OKR-T/3-W12-C OSCILLOGRAMS – Vout = 5V**

On/Off Enable Startup (Vin=13.8V, Vout=5V, Iout=3A, Cload=0)  
Trace 4=Enable, Trace2=Vout

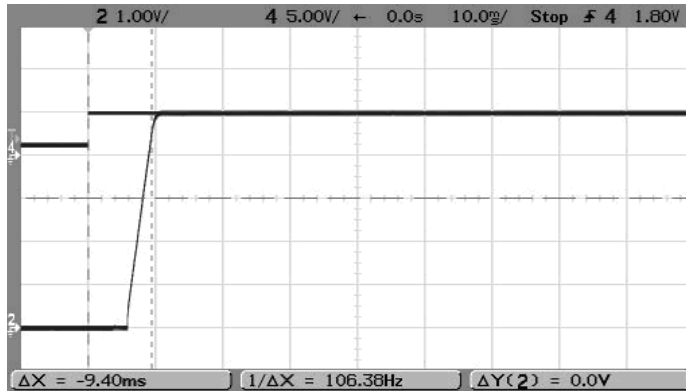

Output Ripple and Noise (Vin=12V, Vout=5V, Iout=3A, Cload=0, ScopeBW=100MHz)

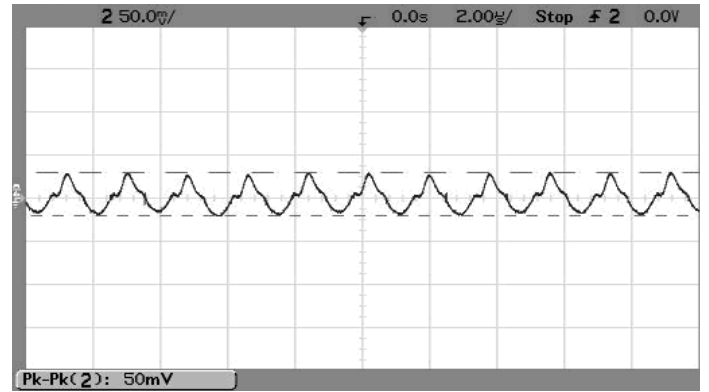

Step Load Transient Response (Vin=12V, Vout=5V, Cload=0, Iout=1.5A to 3A)  
Trace 2=Vout, Trace 4=Iout, 1A/div.

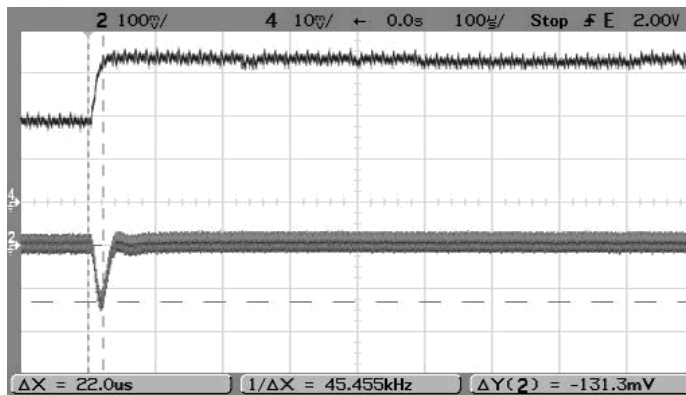

Step Load Transient Response (Vin=12V, Vout=5V, Cload=0, Iout=3A to 1.5A)  
Trace 2=Vout, Trace 4=Iout, 1A/div.

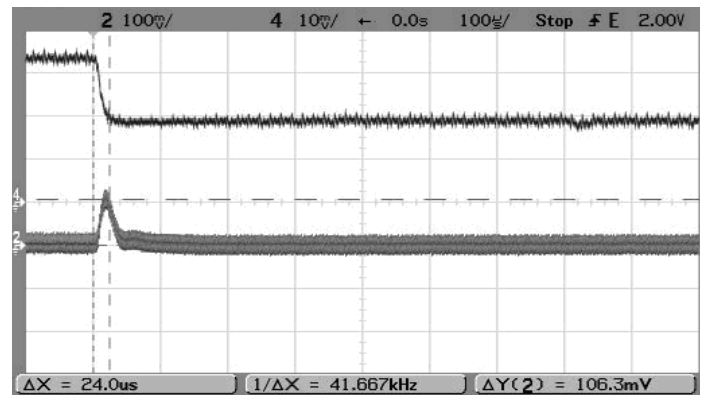

**Soldering Guidelines**

Murata Power Solutions recommends the specifications below when installing these converters. These specifications vary depending on the solder type. Exceeding these specifications may cause damage to the product. Your production environment may differ; therefore please thoroughly review these guidelines with your process engineers.

Wave Solder Operations for through-hole mounted products (THMT)			
For Sn/Ag/Cu based solders:		For Sn/Pb based solders:	
Maximum Preheat Temperature	115° C.	Maximum Preheat Temperature	105° C.
Maximum Pot Temperature	270° C.	Maximum Pot Temperature	250° C.
Maximum Solder Dwell Time	7 seconds	Maximum Solder Dwell Time	6 seconds

**OKR-T/3-W12-C OSCILLOGRAMS – Vout = 1.8V**

Step Load Transient Response (Vin=12V, Vout=1.8V, Cload=5x10µF  
X5R 0805 ceramic, total 50µF, Iout=0A to 3A) Top trace=Vout, Bottom trace=Iout

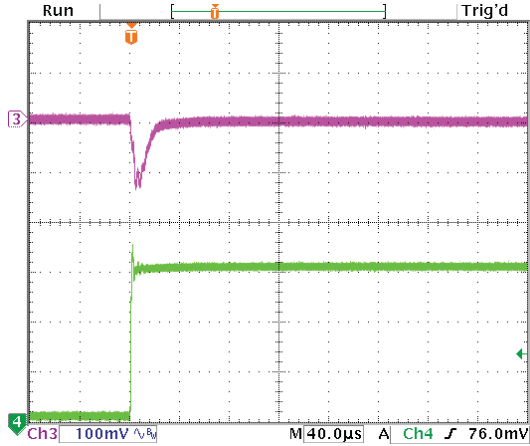

Step Load Transient Response (Vin=12V, Vout=1.8V, Cload=5x10µF  
X5R 0805 ceramic, total 50µF, Iout=3A to 0A) Top trace=Vout, Bottom trace=Iout

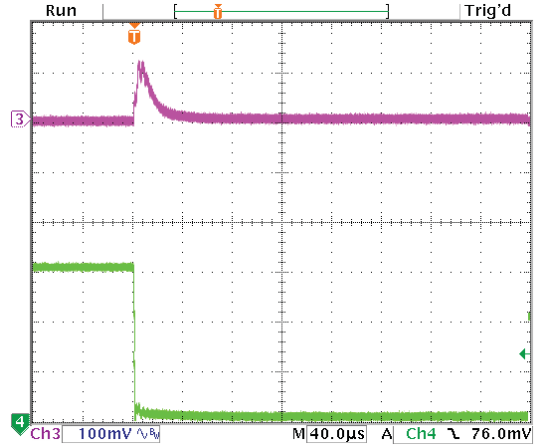

Step Load Transient Response (Vin=4.5V, Vout=1.8V, Cload=5x10µF  
X5R 0805 ceramic, total 50µF, Iout=0A to 3A) Top trace=Vout, Bottom trace=Iout

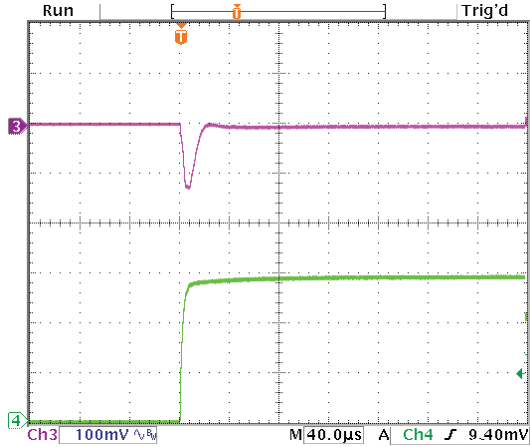

Step Load Transient Response (Vin=4.5V, Vout=1.8V, Cload=5x10µF  
X5R 0805 ceramic, total 50µF, Iout=3A to 0A) Top trace=Vout, Bottom trace=Iout

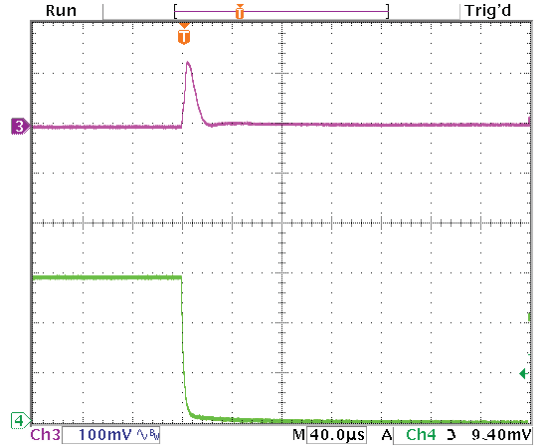

Step Load Transient Response (Vin=12V, Vout=1.8V, Cload=12x10µF  
X5R 0805 ceramic, total 120µF, Iout=0A to 3A) Top trace=Vout, Bottom trace=Iout

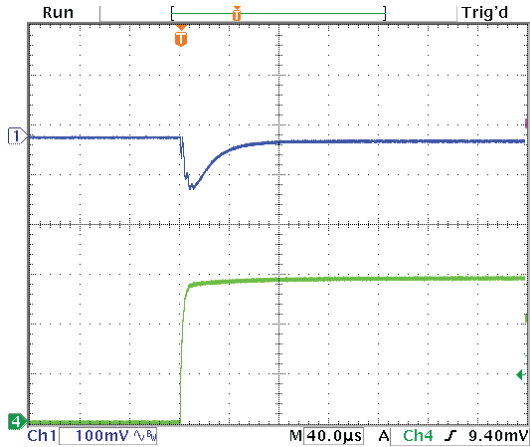

Step Load Transient Response (Vin=12V, Vout=1.8V, Cload=12x10µF  
X5R 0805 ceramic, total 120µF, Iout=3A to 0A) Top trace=Vout, Bottom trace=Iout

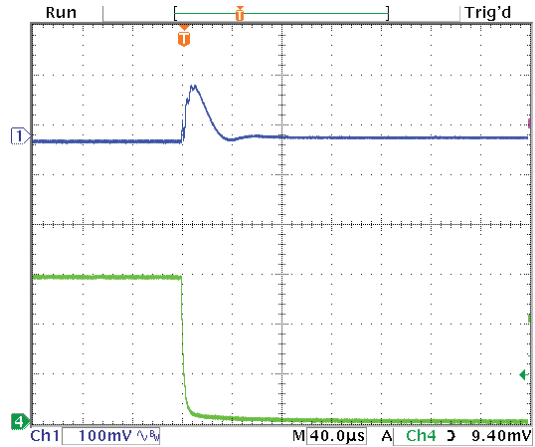



**OKR-T/3-W12-C OSCILLOGRAMS – Vout = 1.8V**

Step Load Transient Response (Vin=4.5V, Vout=1.8V, Cload=12x10µF X5R 0805 ceramic, total 120µF, Iout=0A to 3A) Top trace=Vout, Bottom trace=Iout

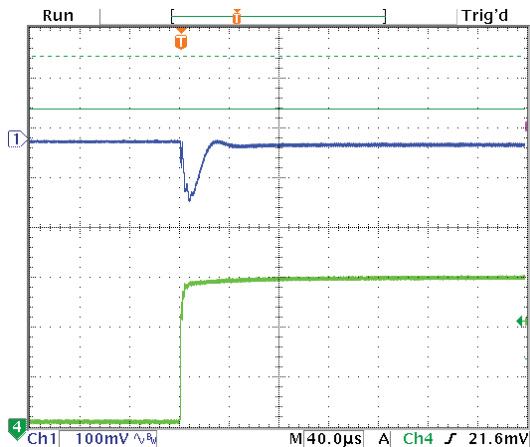

Step Load Transient Response (Vin=4.5V, Vout=1.8V, Cload=12x10µF X5R 0805 ceramic, total 120µF, Iout=3A to 0A) Top trace=Vout, Bottom trace=Iout

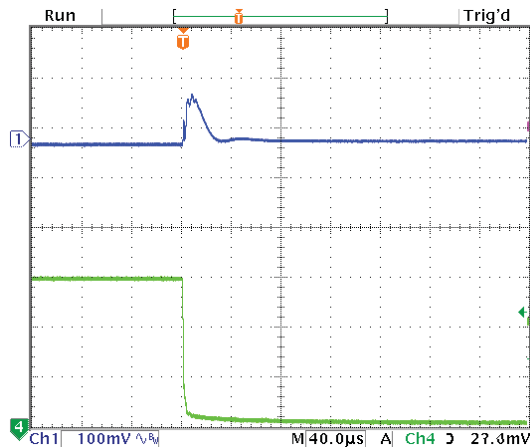

Step Load Transient Response (Vin=4.5V, Vout=1.8V, Cload=10x10µF X5R 0805 ceramic, plus 1x470µF, 7mΩ POSCAP, total 570µF, Iout=0A to 3A) Top trace=Vout, Bottom trace=Iout

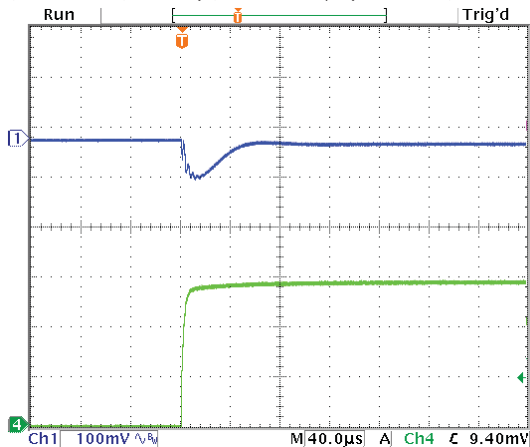

Step Load Transient Response (Vin=4.5V, Vout=1.8V, Cload=10x10µF X5R 0805 ceramic, plus 1x470µF, 7mΩ POSCAP, total 570µF, Iout=3A to 0A) Top trace=Vout, Bottom trace=Iout

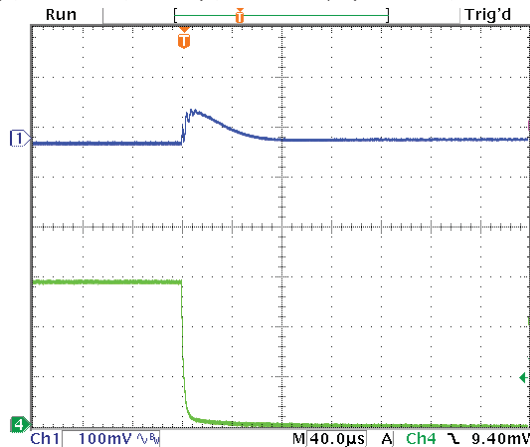

Step Load Transient Response (Vin=12V, Vout=1.8V, Cload=10x10µF X5R 0805 ceramic, plus 1x470µF, 7mΩ POSCAP, total 570µF, Iout=0A to 3A) Top trace=Vout, Bottom trace=Iout

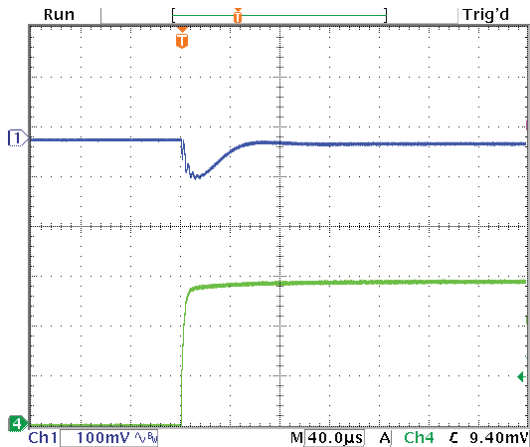

Step Load Transient Response (Vin=12V, Vout=1.8V, Cload=10x10µF X5R 0805 ceramic, plus 1x470µF, 7mΩ POSCAP, total 570µF, Iout=3A to 0A) Top trace=Vout, Bottom trace=Iout

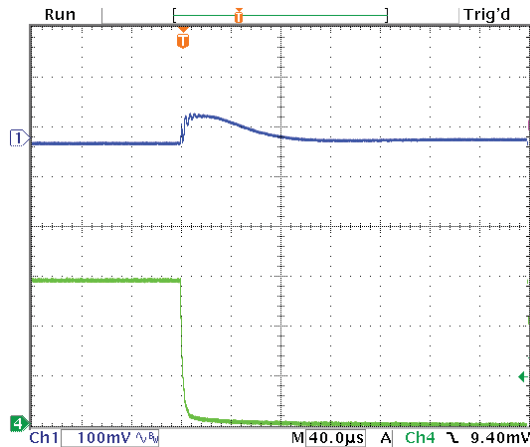

**OKR-T/3-W12-C OSCILLOGRAMS – Vout = 3.3V**

Step Load Transient Response (Vin=12V, Vout=3.3V, Cload=5x10µF  
X5R 0805 ceramic, total 50µF, Iout=0A to 3A) Top trace=Vout, Bottom trace=Iout

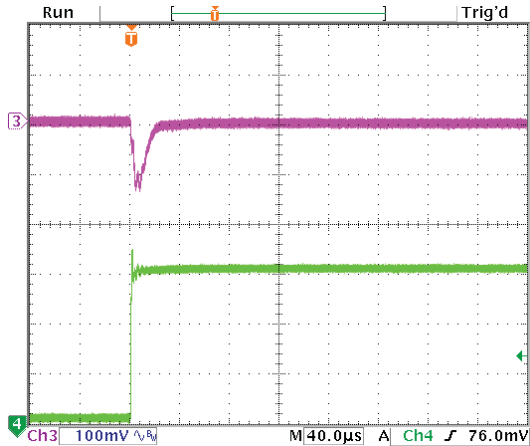

Step Load Transient Response (Vin=12V, Vout=3.3V, Cload=5x10µF  
X5R 0805 ceramic, total 50µF, Iout=3A to 0A) Top trace=Vout, Bottom trace=Iout

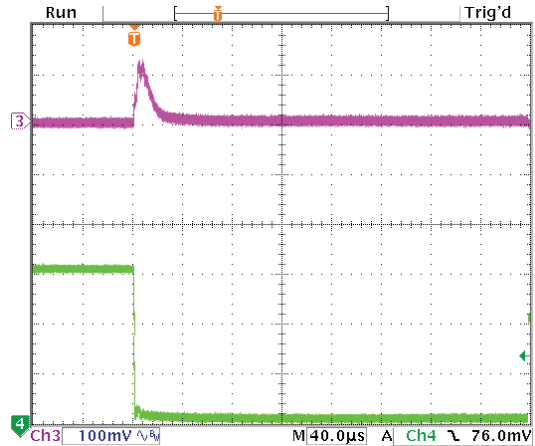

Step Load Transient Response (Vin=5.5V, Vout=3.3V, Cload=5x10µF  
X5R 0805 ceramic, total 50µF, Iout=0A to 3A) Top trace=Vout, Bottom trace=Iout

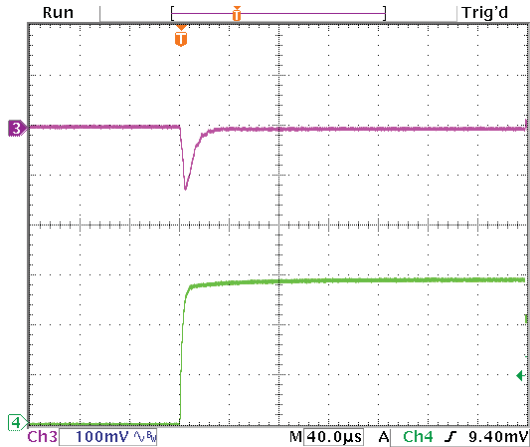

Step Load Transient Response (Vin=5.5V, Vout=3.3V, Cload=5x10µF  
X5R 0805 ceramic, total 50µF, Iout=3A to 0A) Top trace=Vout, Bottom trace=Iout

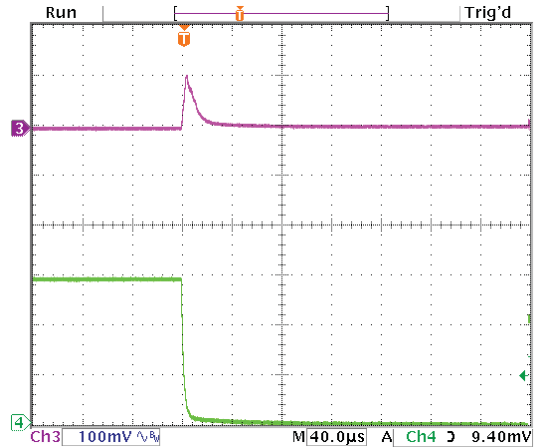

Step Load Transient Response (Vin=12V, Vout=3.3V, Cload=12x10µF  
X5R 0805 ceramic, total 120µF, Iout=0A to 3A) Top trace=Vout, Bottom trace=Iout

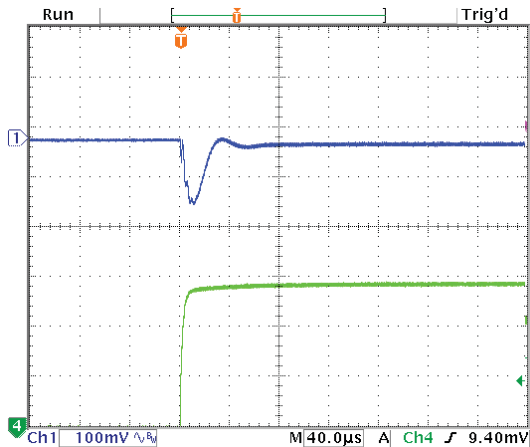

Step Load Transient Response (Vin=12V, Vout=3.3V, Cload=12x10µF  
X5R 0805 ceramic, total 120µF, Iout=3A to 0A) Top trace=Vout, Bottom trace=Iout

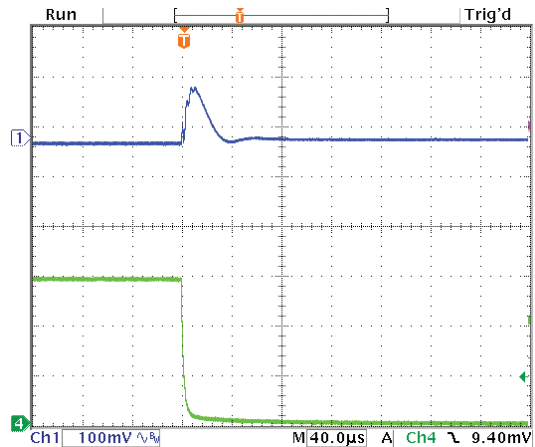

**OKR-T/3-W12-C OSCILLOGRAMS – Vout = 3.3V**

Step Load Transient Response (Vin=5.5V, Vout=3.3V, Cload=12x10µF X5R 0805 ceramic, total 120µF, Iout=0A to 3A) Top trace=Vout, Bottom trace=Iout

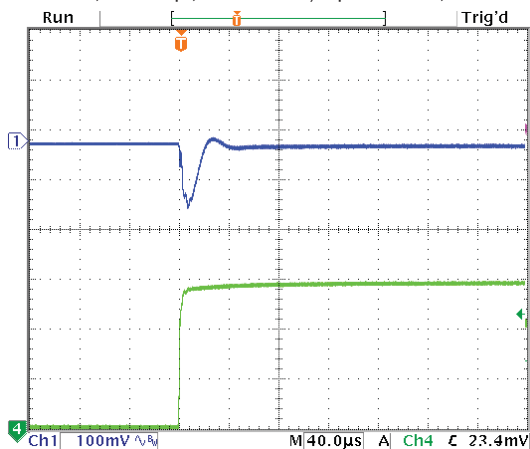

Step Load Transient Response (Vin=5.5V, Vout=3.3V, Cload=12x10µF X5R 0805 ceramic, total 120µF, Iout=3A to 0A) Top trace=Vout, Bottom trace=Iout

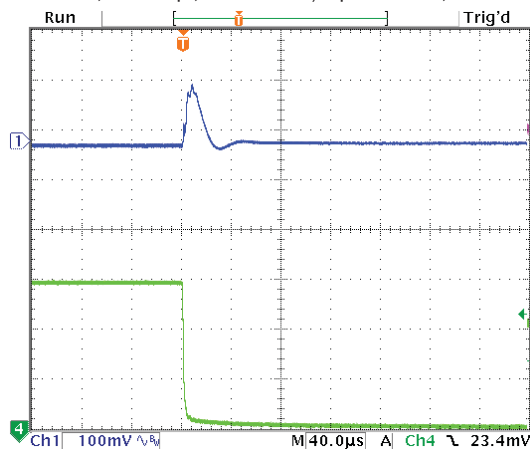

Step Load Transient Response (Vin=5.5V, Vout=3.3V, Cload=10x10µF X5R 0805 ceramic, plus 1x470µF, 7mΩ POSCAP, total 570µF, Iout=0A to 3A) Top trace=Vout, Bottom trace=Iout

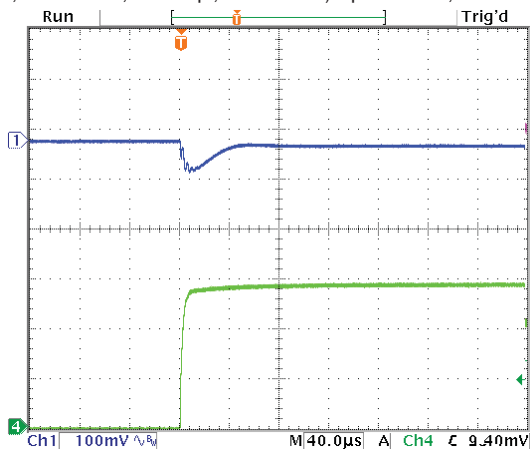

Step Load Transient Response (Vin=5.5V, Vout=3.3V, Cload=10x10µF X5R 0805 ceramic, plus 1x470µF, 7mΩ POSCAP, total 570µF, Iout=3A to 0A) Top trace=Vout, Bottom trace=Iout

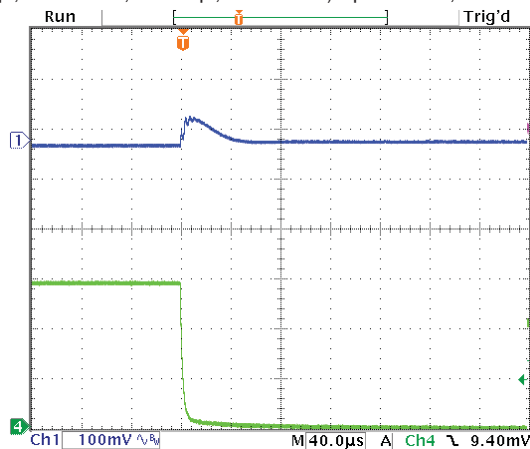

Step Load Transient Response (Vin=12V, Vout=3.3V, Cload=10x10µF X5R 0805 ceramic, plus 1x470µF, 7mΩ POSCAP, total 570µF, Iout=0A to 3A) Top trace=Vout, Bottom trace=Iout

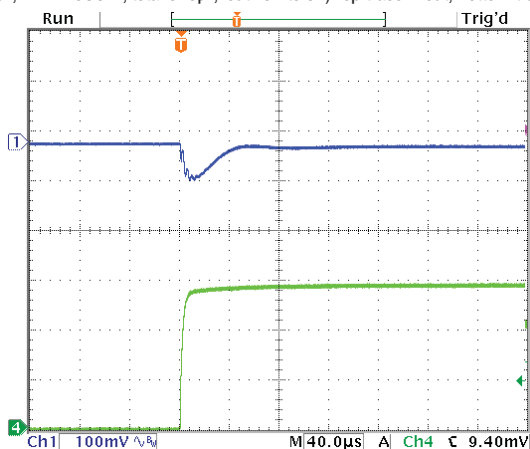

Step Load Transient Response (Vin=12V, Vout=3.3V, Cload=10x10µF 5R 0805 ceramic, plus 1x470µF, 7mΩ POSCAP, total 570µF, Iout=3A to 0A) Top trace=Vout, Bottom trace=Iout

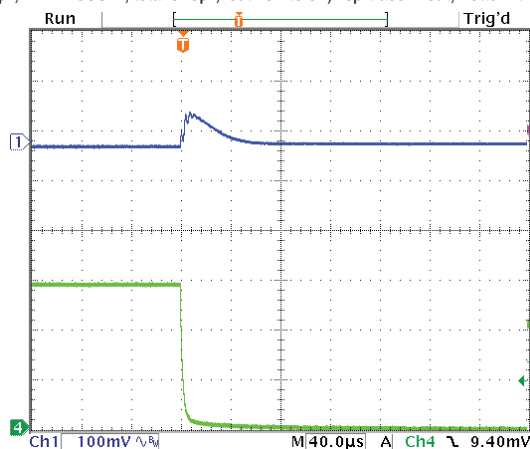

**OKR-T/3-W12-C OSCILLOGRAMS – Vout = 5V**

Step Load Transient Response (Vin=12V, Vout=5V, Cload=5x10µF X5R 0805 ceramic, total 50µF, Iout=0A to 3A) Top trace=Vout, Bottom trace=Iout

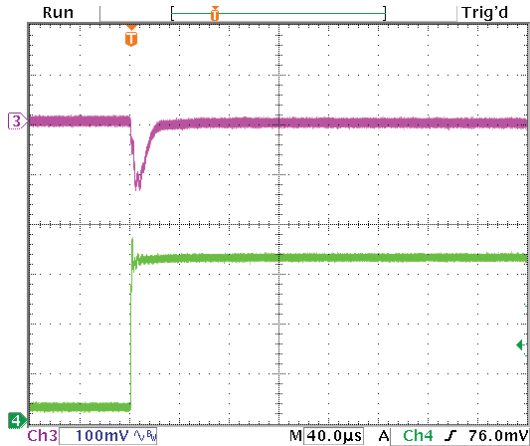

Step Load Transient Response (Vin=12V, Vout=5V, Cload=5x10µF X5R 0805 ceramic, total 50µF, Iout=3A to 0A) Top trace=Vout, Bottom trace=Iout

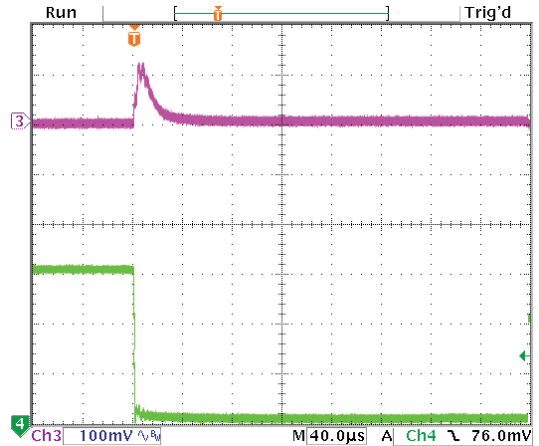

Step Load Transient Response (Vin=7.5V, Vout=5V, Cload=5x10µF X5R 0805 ceramic, total 50µF, Iout=0A to 3A) Top trace=Vout, Bottom trace=Iout

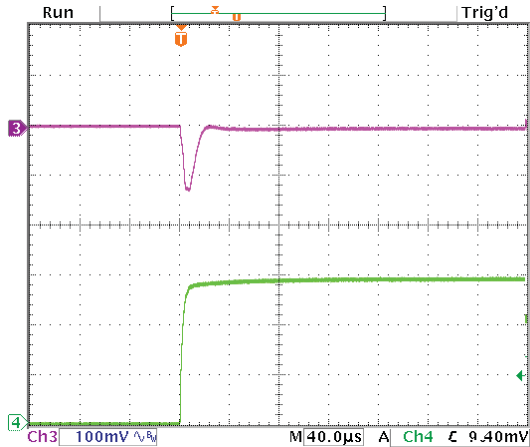

Step Load Transient Response (Vin=7.5V, Vout=5V, Cload=5x10µF X5R 0805 ceramic, total 50µF, Iout=3A to 0A) Top trace=Vout, Bottom trace=Iout

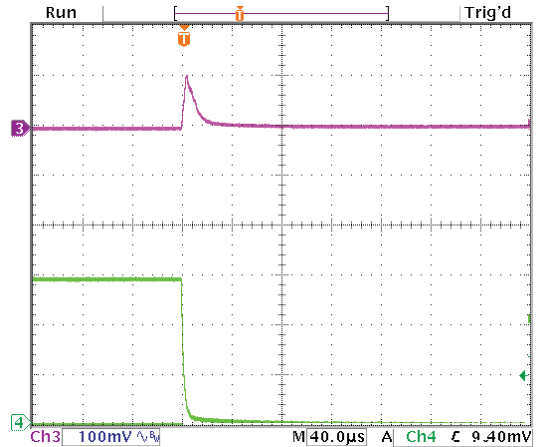

Step Load Transient Response (Vin=12V, Vout=5V, Cload=12x10µF X5R 0805 ceramic, total 120µF, Iout=0A to 3A) Top trace=Vout, Bottom trace=Iout

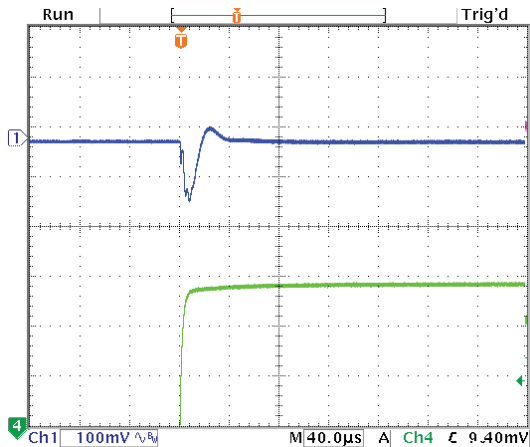

Step Load Transient Response (Vin=12V, Vout=5V, Cload=12x10µF X5R 0805 ceramic, total 120µF, Iout=3A to 0A) Top trace=Vout, Bottom trace=Iout

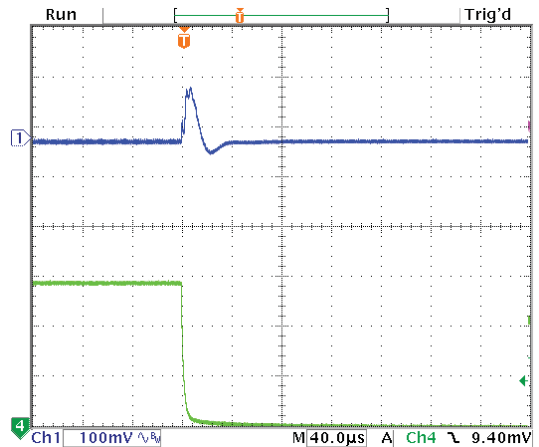

**OKR-T/3-W12-C OSCILLOGRAMS – Vout = 5V**

Step Load Transient Response (Vin=7.5V, Vout=5V, Cload=12x10µF X5R 0805 ceramic, total 120µF, Iout=0A to 3A) Top trace=Vout, Bottom trace=Iout

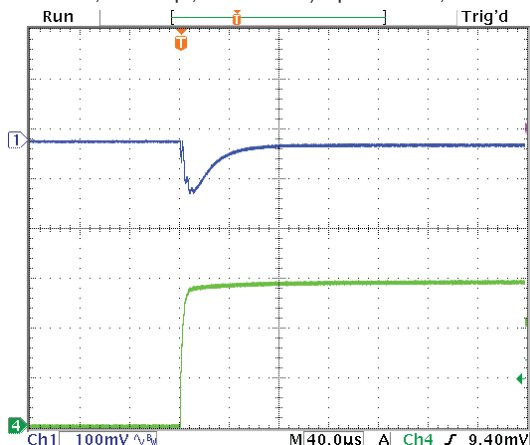

Step Load Transient Response (Vin=7.5V, Vout=5V, Cload=12x10µF X5R 0805 ceramic, total 120µF, Iout=3A to 0A) Top trace=Vout, Bottom trace=Iout

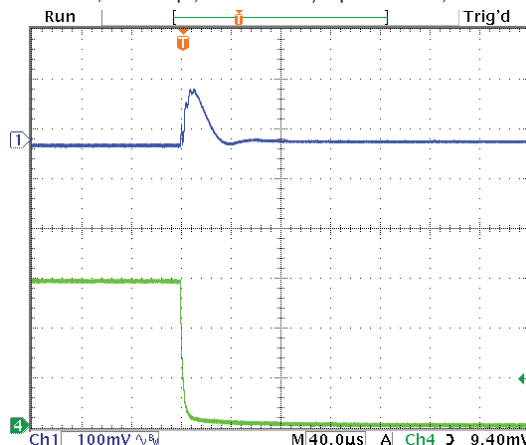

Step Load Transient Response (Vin=7.5V, Vout=5V, Cload=10x10µF X5R 0805 ceramic, plus 1x470µF, 7mΩ POSCAP, total 570µF, Iout=0A to 3A) Top trace=Vout, Bottom trace=Iout

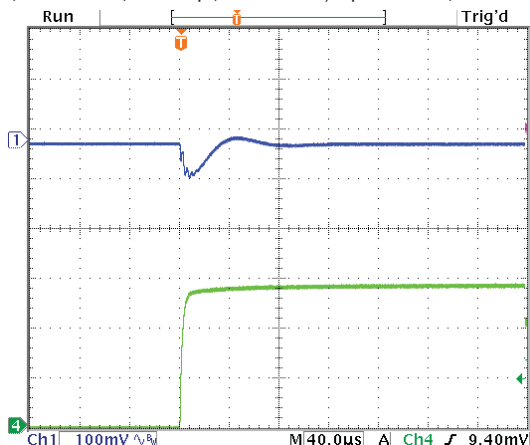

Step Load Transient Response (Vin=7.5V, Vout=5V, Cload=10x10µF X5R 0805 ceramic, plus 1x470µF, 7mΩ POSCAP, total 570µF, Iout=3A to 0A) Top trace=Vout, Bottom trace=Iout

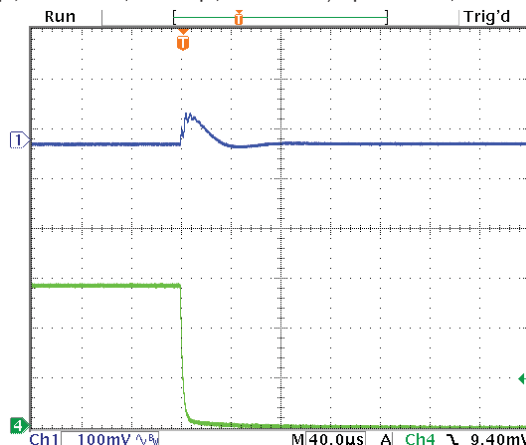

Step Load Transient Response (Vin=12V, Vout=5V, Cload=10x10µF X5R 0805 ceramic, plus 1x470µF, 7mΩ POSCAP, total 570µF, Iout=0A to 3A) Top trace=Vout, Bottom trace=Iout

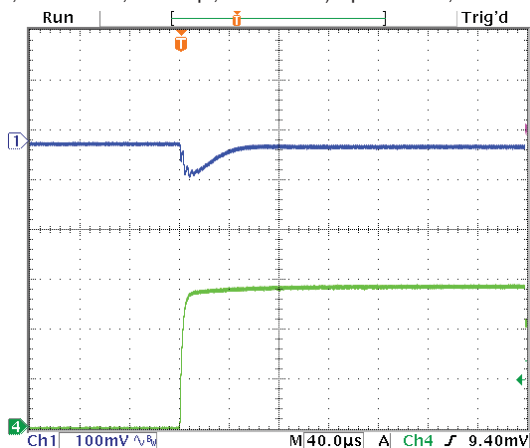

Step Load Transient Response (Vin=12V, Vout=5V, Cload=10x10µF X5R 0805 ceramic, plus 1x470µF, 7mΩ POSCAP, total 570µF, Iout=3A to 0A) Top trace=Vout, Bottom trace=Iout

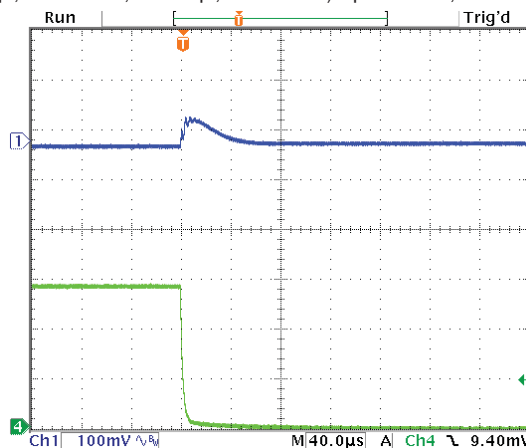

**MECHANICAL SPECIFICATIONS**

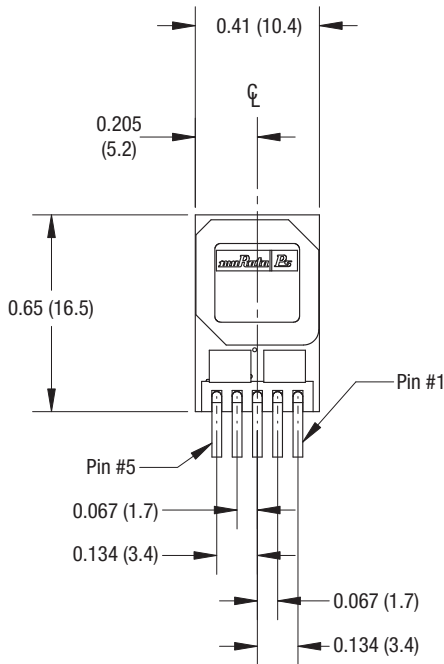

Pin diameter: 0.032 (0.81)  
 Tolerance: ±0.002 (±0.05)  
 Pin material: Copper alloy  
 Pin finish: Pure matte tin 100-300 µin.  
 over 75-100 µin. nickel

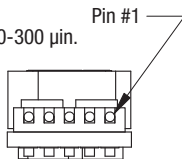

**RECOMMENDED FOOTPRINT  
(VIEWED FROM TOP)**

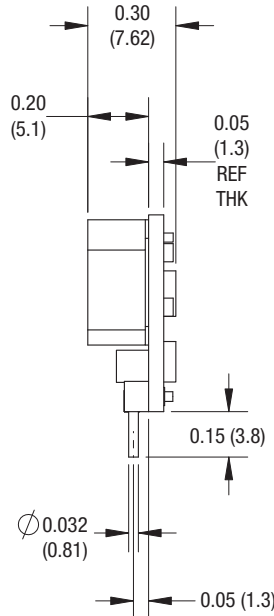
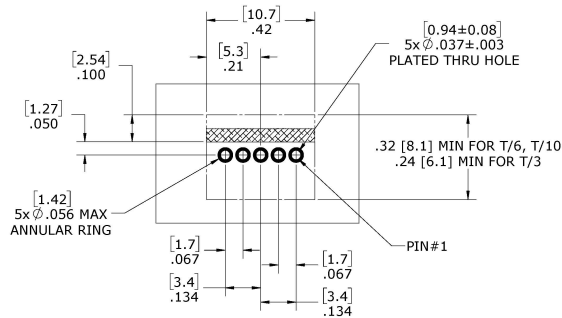

**OKR-T/6  
OKR-T/10  
Case C90**

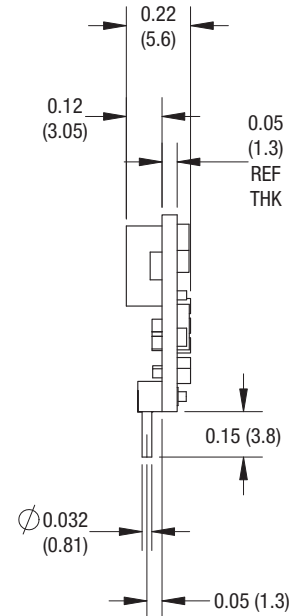

**OKR-T/3  
Case C72**



Figure 3. OKR Series  
Component locations are typical.

Dimensions are in inches (mm shown for ref. only).

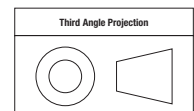

Tolerances (unless otherwise specified):  
 .XX ± 0.02 (0.5)  
 .XXX ± 0.010 (0.25)  
 Angles ± 2°

Components are shown for reference only.

INPUT/OUTPUT CONNECTIONS OKR-T-W12	
Pin	Function P73
1	Remote On/Off Control
2	+VIN
3	Ground
4	+VOUT
5	Output Trim

**STANDARD PACKAGING**

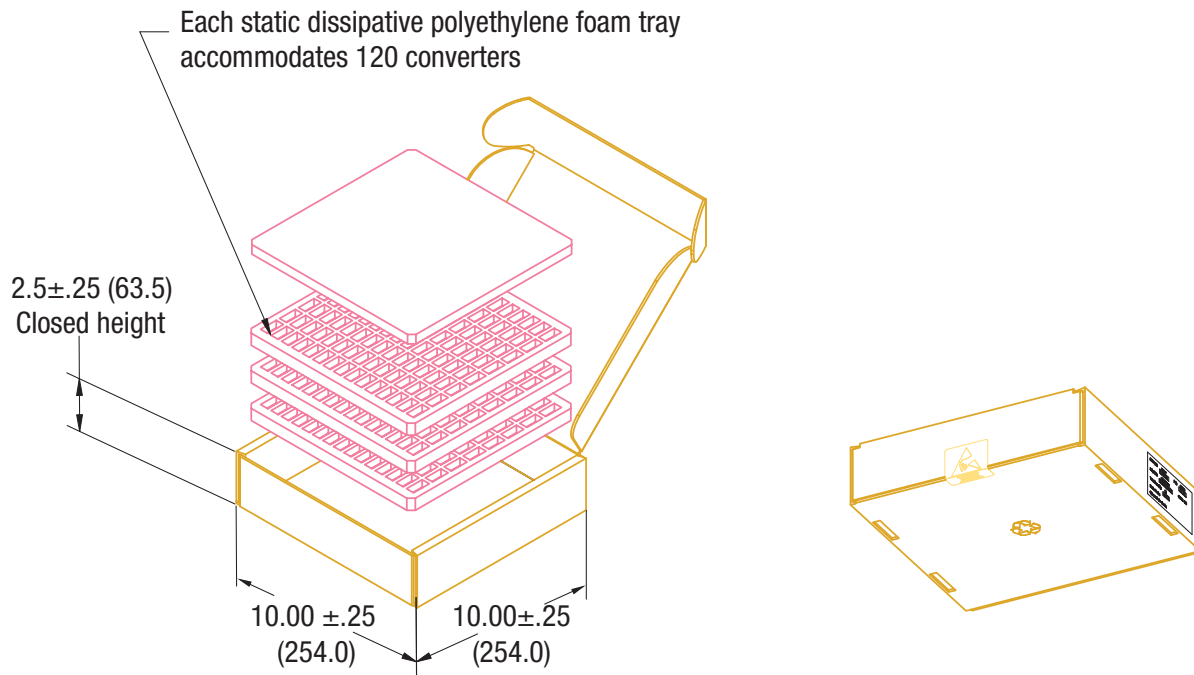

Carton accommodates three (3) trays of 120 yielding 360 converters per carton.

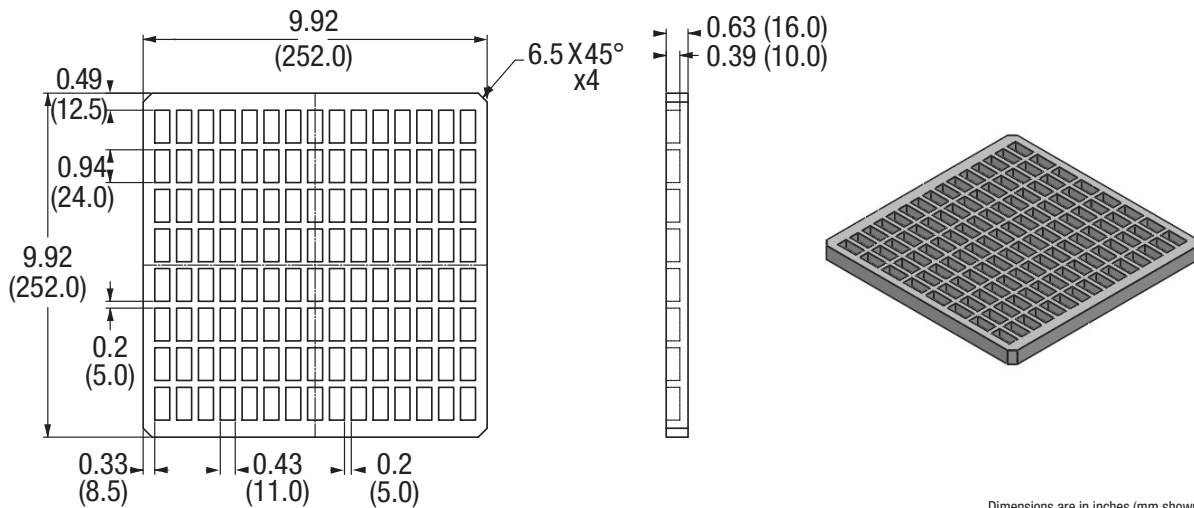

**Notes:**

1. Material: Dow 220 antistat ethafoam (Density: 34-35 kg/m<sup>3</sup>)
2. Dimensions: 252 x 252 x 16 mm  
8 x 15 array (120 per tray)

Dimensions are in inches (mm shown for ref. only).

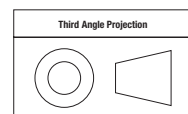

Tolerances (unless otherwise specified):  
 .XX ± 0.02 (0.5)  
 .XXX ± 0.010 (0.25)  
 Angles ± 2°

Components are shown for reference only.

**TECHNICAL NOTES**

**Input Fusing**

Certain applications and/or safety agencies may require fuses at the inputs of power conversion components. Fuses should also be used when there is the possibility of sustained input voltage reversal which is not current-limited. For greatest safety, we recommend a fast blow fuse installed in the ungrounded input supply line.

The installer must observe all relevant safety standards and regulations. For safety agency approvals, install the converter in compliance with the end-user safety standard, i.e. IEC/EN/UL 60950-1.

**Input Under-Voltage Shutdown and Start-Up Threshold**

Under normal start-up conditions, converters will not begin to regulate properly until the ramping-up input voltage exceeds and remains at the Start-Up Threshold Voltage (see Specifications). Once operating, converters will not turn off until the input voltage drops below the Under-Voltage Shutdown Limit. Subsequent restart will not occur until the input voltage rises again above the Start-Up Threshold. This built-in hysteresis prevents any unstable on/off operation at a single input voltage.

Users should be aware however of input sources near the Under-Voltage Shutdown whose voltage decays as input current is consumed (such as capacitor inputs), the converter shuts off and then restarts as the external capacitor recharges. Such situations could oscillate. To prevent this, make sure the operating input voltage is well above the UV Shutdown voltage AT ALL TIMES.

**Start-Up Time**

Assuming that the output current is set at the rated maximum, the Vin to Vout Start-Up Time (see Specifications) is the time interval between the point when the ramping input voltage crosses the Start-Up Threshold and the fully loaded regulated output voltage enters and remains within its specified accuracy band. Actual measured times will vary with input source impedance, external input capacitance, input voltage slew rate and final value of the input voltage as it appears at the converter.

These converters include a soft start circuit to moderate the duty cycle of its PWM controller at power up, thereby limiting the input inrush current.

The On/Off Remote Control interval from On command to Vout regulated assumes that the converter already has its input voltage stabilized above the Start-Up Threshold before the On command. The interval is measured from the On command until the output enters and remains within its specified accuracy band. The specification assumes that the output is fully loaded at maximum rated current. Similar conditions apply to the On to Vout regulated specification such as external load capacitance and soft start circuitry.

**Recommended Input Filtering**

The user must assure that the input source has low AC impedance to provide dynamic stability and that the input supply has little or no inductive content, including long distributed wiring to a remote power supply. The converter will operate with no additional external capacitance if these conditions are met.

For best performance, we recommend installing a low-ESR capacitor immediately adjacent to the converter's input terminals. The capacitor should be a ceramic type such as the Murata GRM32 series or a polymer type. Initial suggested capacitor values are 10 to 22  $\mu\text{F}$ , rated at twice the expected maximum input voltage. Make sure that the input terminals do not go below the undervoltage shutdown voltage at all times. More input bulk capacitance may be added in parallel (either electrolytic or tantalum) if needed.

**Recommended Output Filtering**

The converter will achieve its rated output ripple and noise with no additional external capacitor. However, the user may install more external output capacitance to reduce the ripple even further or for improved dynamic response. Again, use low-ESR ceramic (Murata GRM32 series) or polymer capacitors. Initial values of 10 to 47  $\mu\text{F}$  may be tried, either single or multiple capacitors in parallel. Mount these close to the converter. Measure the output ripple under your load conditions.

Use only as much capacitance as required to achieve your ripple and noise objectives. Excessive capacitance can make step load recovery sluggish or possibly introduce instability. Do not exceed the maximum rated output capacitance listed in the specifications.

**Input Ripple Current and Output Noise**

All models in this converter series are tested and specified for input reflected ripple current and output noise using designated external input/output components, circuits and layout as shown in the figures below. In the figure below, the Cbus and Lbus components simulate a typical DC voltage bus. Please note that the values of Cin, Lbus and Cbus will vary according to the specific converter model.

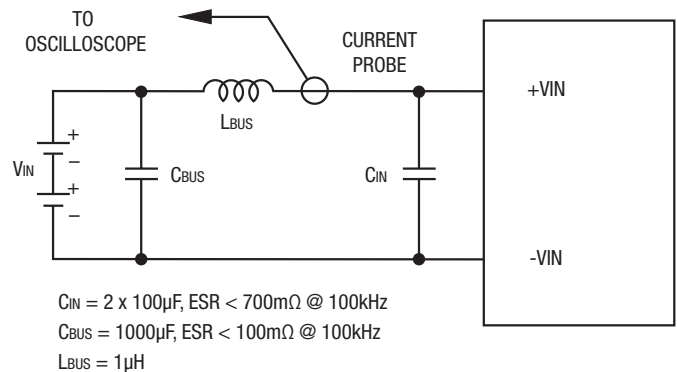

Figure 4. Measuring Input Ripple Current



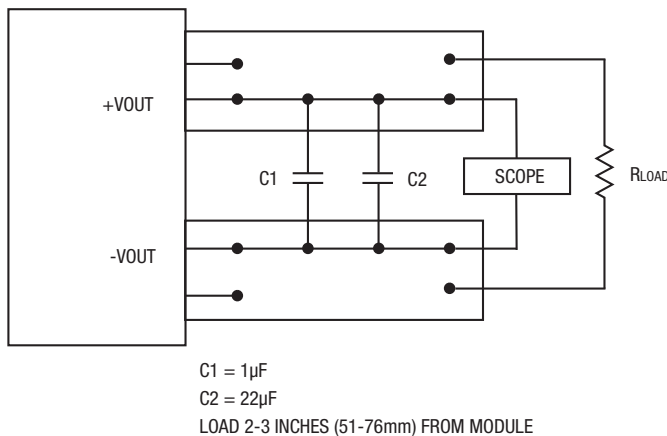

Figure 5. Measuring Output Ripple and Noise (PARD)

**Minimum Output Loading Requirements**

All models regulate within specification and are stable under no load to full load conditions. Operation under no load might however slightly increase output ripple and noise.

**Thermal Shutdown**

To prevent many over temperature problems and damage, these converters include thermal shutdown circuitry. If environmental conditions cause the temperature of the DC/DC's to rise above the Operating Temperature Range up to the shutdown temperature, an on-board electronic temperature sensor will power down the unit. When the temperature decreases below the turn-on threshold, the converter will automatically restart. There is a small amount of hysteresis to prevent rapid on/off cycling. The temperature sensor is typically located adjacent to the switching controller, approximately in the center of the unit. See the Performance and Functional Specifications.

**CAUTION:** If you operate too close to the thermal limits, the converter may shut down suddenly without warning. Be sure to thoroughly test your application to avoid unplanned thermal shutdown.

**Temperature Derating Curves**

The graphs in this data sheet illustrate typical operation under a variety of conditions. The Derating curves show the maximum continuous ambient air temperature and decreasing maximum output current which is acceptable under increasing forced airflow measured in Linear Feet per Minute (“LFM”). Note that these are AVERAGE measurements. The converter will accept brief increases in current or reduced airflow as long as the average is not exceeded.

Note that the temperatures are of the ambient airflow, not the converter itself which is obviously running at higher temperature than the outside air. Also note that very low flow rates (below about 25 LFM) are similar to “natural convection”, that is, not using fan-forced airflow.

Murata Power Solutions makes Characterization measurements in a closed cycle wind tunnel with calibrated airflow. We use both thermocouples and an infrared camera system to observe thermal performance.

**CAUTION:** If you routinely or accidentally exceed these Derating guidelines, the converter may have an unplanned Over Temperature shut down. Also, these graphs are all collected at slightly above Sea Level altitude. Be sure to reduce the derating for higher density altitude.

**Output Current Limiting**

Current limiting inception is defined as the point at which full power falls below the rated tolerance. See the Performance/Functional Specifications. Note particularly that the output current may briefly rise above its rated value in normal operation as long as the average output power is not exceeded. This enhances reliability and continued operation of your application. If the output current is too high, the converter will enter the short circuit condition.

**Output Short Circuit Condition**

When a converter is in current-limit mode, the output voltage will drop as the output current demand increases. If the output voltage drops too low (approximately 98% of nominal output voltage for most models), the magnetically coupled voltage used to develop primary side voltages will also drop, thereby shutting down the PWM controller. Following a time-out period, the PWM will restart, causing the output voltage to begin ramping up to its appropriate value. If the short-circuit condition persists, another shutdown cycle will initiate. This rapid on/off cycling is called “hiccup mode”. The hiccup cycling reduces the average output current, thereby preventing excessive internal temperatures and/or component damage. A short circuit can be tolerated indefinitely.

The “hiccup” system differs from older latching short circuit systems because you do not have to power down the converter to make it restart. The system will automatically restore operation as soon as the short circuit condition is removed.

**Remote On/Off Control (for models without the “E” option)**

Please refer to the Connection Diagram on page 1 for On/Off connections.

Positive logic models are enabled when the On/Off pin is left open or is pulled high to +Vin with respect to –Vin. Positive-logic devices are disabled when the On/Off is grounded or brought to within a low voltage (see Specifications) with respect to –Vin.

Dynamic control of the On/Off function should be able to sink appropriate signal current when brought low and withstand appropriate voltage when brought high. Be aware too that there is a finite time in milliseconds (see Specifications) between the time of On/Off Control activation and stable, regulated output. This time will vary slightly with output load type and current and input conditions.

**“E” Model External Enable On/Off Control (see fig. 6)**

The forced On/Off enable option for “E” models uses positive logic for the external control. The converter may be powered ON by applying a positive voltage (logic HI) between the On/Off pin and the negative power input (-Vin). This positive voltage is referred to -Vin and must be in the range of at least +2.0V and not to exceed the power supply input voltage (+Vin). The current drain is 1 mA max. when turned on.

If the On/Off pin is left open, an internal 100 Kiloohm pulldown resistor will turn the converter OFF. The OFF condition may also be commanded by grounding the pin or from an external logic LO voltage not to exceed +0.4 Volts. All voltages are referred to the -Vin negative power input.

If you wish to control the On/Off circuit by external logic rather than a switch, carefully compare your logic threshold voltages with that of the On/Off input.

The circuit below indicates the equivalent input. Please avoid false signals from ground bounce errors on the On/Off control. Also note that the external control signal is wired directly into the Q3 BSS138W gate which can be damaged by electrostatic transient voltages. Do not exceed the specifications.

**Output Capacitive Load**

These converters do not require external capacitance added to achieve rated specifications. Users should only consider adding capacitance to reduce switching noise and/or to handle spike current load steps. Install only enough capacitance to achieve noise objectives. Excess external capacitance may cause regulation problems, degraded transient response and possible oscillation or instability.

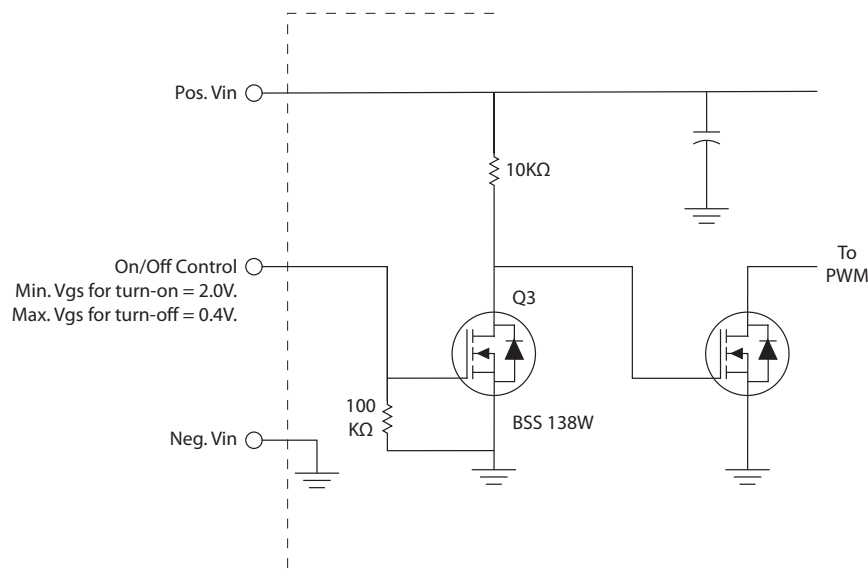

Figure 6. On/Off Control Circuit for “E” Models



# Mouser Electronics

Authorized Distributor

Click to View Pricing, Inventory, Delivery & Lifecycle Information:

[Murata:](#)

[OKR-T/3-W12-C](#)