

SERIES 88
Sealed, Flange Mounted

FEATURES

- Sealed Keyboard
- Colorful Graphic Overlay
- Audible, Snap-Dome Contact
- User Legendable Styles
- 3,000,000 Operations per Button
- Optional Panel Seal Gasket to Protect Your Equipment



DIMENSIONS in inches (and millimeters)

3x4 Keyboard

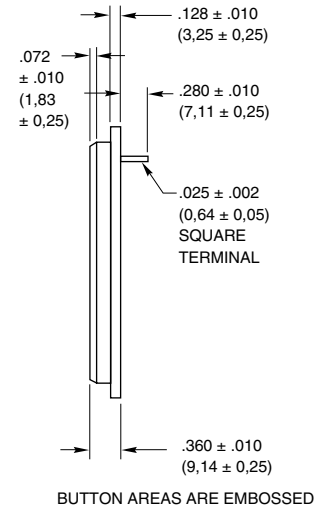
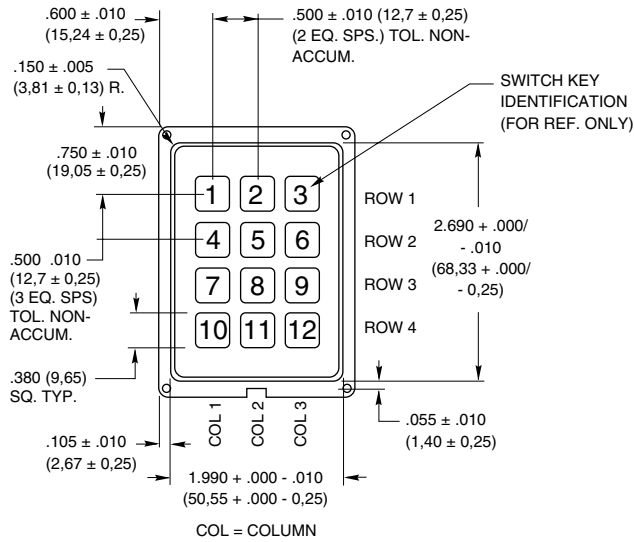

BUTTON AREAS ARE EMBOSSED

Termination in inches (and millimeters)

3x4

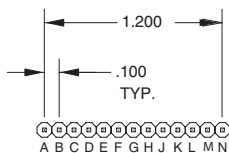
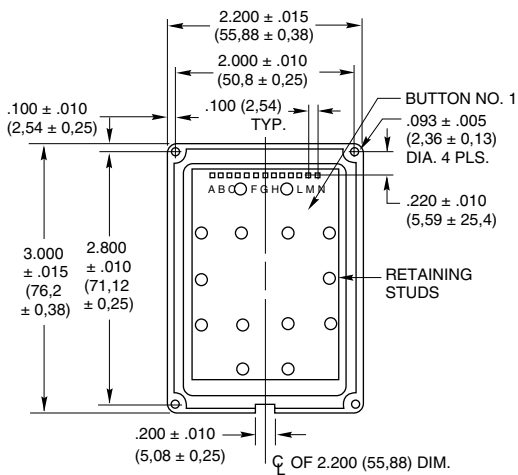

SINGLE POLE COMMON BUS TERMINAL

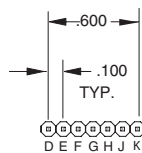

MATRIX TERMINAL PIN-OUT

Code and Truth Table

Dots in the chart indicate connected terminals when switch is closed. Terminals are identified on the keyboard.

3x4		CODES																			
		Matrix						Single Pole/Common Bus													
BUTTON LOCATION	1	•																			
	2		•																		
	3			•																	
	4				•																
	5					•															
	6						•														
	7							•													
	8								•												
	9									•											
	10										•										
	11											•									
	12												•								
		F	E	D	K	J	H	G	J	E	A	K	F	B	L	G	C	M	H	D	N
TERMINAL LOCATION																					

SERIES 88
Sealed, Flange Mounted

FEATURES

- Sealed Keyboard
- Colorful Graphic Overlay
- Audible, Snap-Dome Contact
- User Legendable Styles
- 3,000,000 Operations per Button
- Optional Panel Seal Gasket to Protect Your Equipment



DIMENSIONS in inches (and millimeters)

5x4 Keyboard

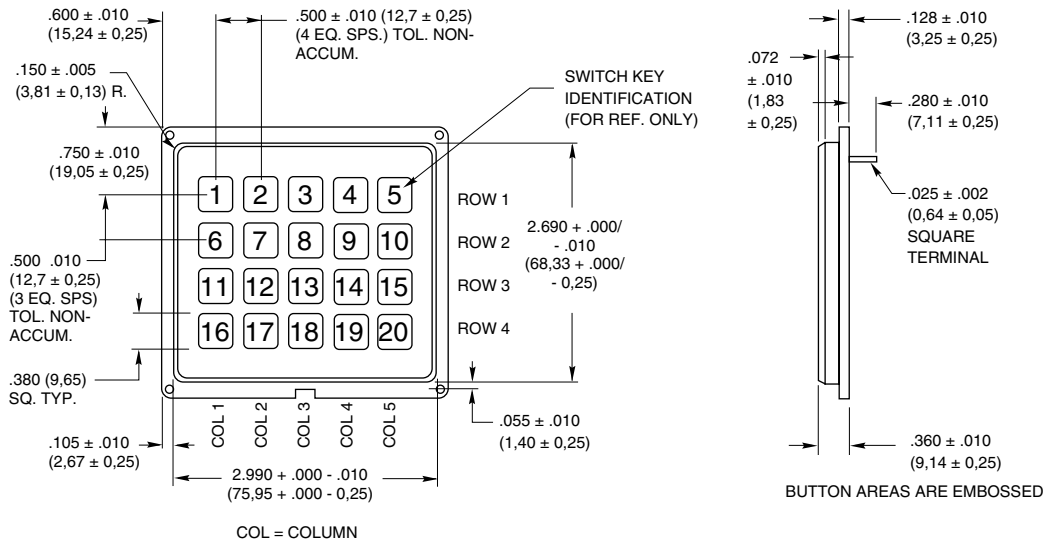

Termination in inches (and millimeters)

5x4 Keyboard

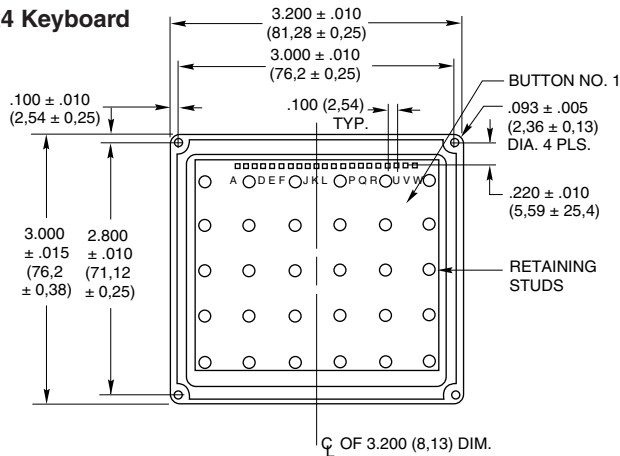

Code and Truth Table

Dots in the chart indicate connected terminals when switch is closed. Terminals are identified on the keyboard.

5x4	CODES	
	Matrix	Single Pole/Common Bus
1	•	•
2	•	•
3	•	•
4	•	•
5	•	•
6	•	•
7	•	•
8	•	•
9	•	•
10	•	•
11	•	•
12	•	•
13	•	•
14	•	•
15	•	•
16	•	•
17	•	•
18	•	•
19	•	•
20	•	•
	P N K G F J L M H	T P M H D U Q L G C V R K F B W S J E A N
	TERMINAL LOCATION	

SPECIFICATIONS

Rating Criteria

Rating at 24 Vdc: 10 milliamps, resistive

Contact Resistance: Compatible with MOS, TTL and DTL (10 ohms maximum)

Voltage Breakdown: 250Vac between mutually insulated parts

Life Expectancy: 3,000,000 operations per button

Contact Bounce: Less than 4 milliseconds at make, 10 milliseconds at break

Temperature: -40°C to +80°C

Operating Features

Button Travel: 0.015"(0,38 mm) nominal total travel

Typical Operating Force: 350 grams

Materials and Finishes

Housing: ABS polycarbonate, black

Graphic Overlay: Polyester

Contact Dome: Stainless steel, selectively gold-plated

Terminals: Phosphor bronze

STANDARD LEGENDS

Colorful graphic overlays are polyester with a tough acrylic bond to provide maximum protection against dirt and moisture. Second surface printed, the overlay wipes clean and

continues to look bright and bold throughout the keyboard life. Available through distributors. For instant custom legends, order separate blank keyboards as indicated in the Ordering

Information section and choose one of the clear window overlays below; then order a sheet of legend inserts. Or, if you prefer, order the keyboard custom printed by Grayhill; see Ordering Information.



-143



-152



-172

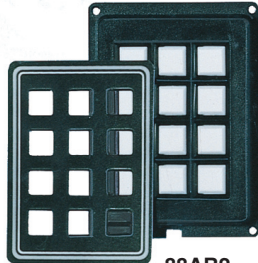

88-101

88AB2, 88AC2



-052



-072



-082

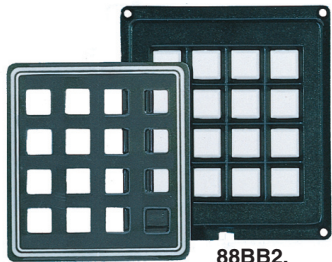

88-001

88BB2, 88BC2

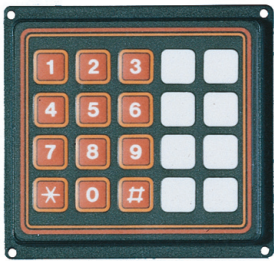

-252

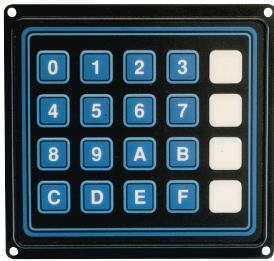

-262

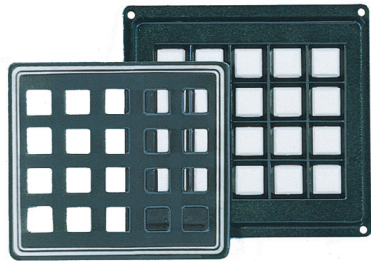

88-201

88JB2, 88JC2

SEALING OF KEYBOARDS

The graphic legend is silk-screen printed on the second surface of a clear polyester film, providing maximum legend protection. It withstands high humidity, and it is resistant to scratching, marring, and dulling of the surface caused by fingernails, wiping cloths, and cleaning materials. It has excellent solvent resistance to water, petroleum oil, alcohols and aliphatic hydrocarbons.

These common liquids do not attack the overlay: 5% acetic acid, 5% citric acid, 2%

detergent solution, soapy water, 30% hydrogen peroxide, wine, beer, whiskey, coffee, cocoa, milk, tomato juice, lemon juice, etc. Hydrocarbons, ketones and freon do not affect the overlay. But, we recommend that you do not subject the keyboard to these chemicals, since they may affect the switch housing, which is ABS plastic. To discuss a particular solvent, contact Grayhill.

Protect your equipment in outdoor or harsh environmental conditions by sealing the keyboard to the equipment panel. Use an optional gasket

with the keyboard. There are two types of gaskets: one for mounting the keyboard beneath the panel, and one for mounting it above the equipment panel. See Panel Seal Gaskets.

The contact system is internally sealed by a special adhesive backed sheet that holds the domes in position on the PC board.

Keyboards and Key pads

PANEL SEAL GASKETS

Weatherproof and waterproof your subpanel and topside mounted keyboards with optional panel seal gaskets.

Subpanel keyboard gasket is .062" (1,57 mm) thick; topside keyboard gasket is .094" (2,39 mm).

Material is cellulose fiber, foam, nitrile rubber. Order gaskets separately from keyboard.

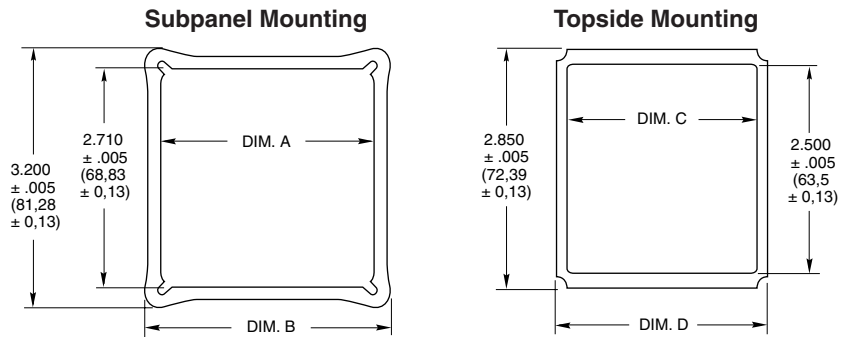

- Subpanel 3x4 **Part No. 88M2001-2**
- Subpanel 4x4 **Part No. 88M2009-2**
- Subpanel 5x4 **Part No. 88M2019-1**

- Topside 3x4 **Part No. 88M2012-1**
- Topside 4x4 **Part No. 88M2015-1**
- Topside 5x4 **Part No. 88M2018-1**

Size of Keyboard	Subpanel Mount		Topside Mount	
	Dim. A	Dim. B	Dim. C	Dim. D
3x4	2.010 ± .005 (51,05 ± 0,13)	2.400 ± .005 (60,96 ± 0,13)	1.800 ± .005 (45,72 ± 0,13)	2.040 ± .005 (51,82 ± 0,13)
4x4	2.510 ± .005 (63,75 ± 0,13)	2.900 ± .005 (73,66 ± 0,13)	2.300 ± .005 (58,42 ± 0,13)	2.540 ± .005 (64,52 ± 0,13)
5x4	3.010 ± .005 (76,45 ± 0,13)	3.400 ± .005 (86,36 ± 0,13)	2.800 ± .005 (71,12 ± 0,13)	3.040 ± .005 (77,22 ± 0,13)

INSTANT CUSTOM LEGENDS

Available through Distributors

Create your own legends using these 3 items: 1) a blank keyboard, 2) the clear window overlays shown on Standard Legend page and 3) a sheet of legend inserts.

Blank Keyboards

The numbers below order blank keyboards for the user to legend. For description, refer to the part numbering scheme below. The keyboards and overlays are ordered separately.

- 3x4 Matrix **Part No. 88AB2**
- 3x4 SP/Com Bus **Part No. 88AC2**
- 4x4 Matrix **Part No. 88BB2**
- 4x4 SP/Com Bus **Part No. 88BC2**
- 5x4 Matrix **Part No. 88JB2**
- 5x4 SP/Com Bus **Part No. 88JC2**

Legend Insert Sheet and Dry Transfers

Self-adhesive inserts are die-cut to fit the

button. Legends are printed in black on clear film in News Gothic Condensed type style. They include letters A through Z, numbers 0-69, telephone legends, commonly used words, symbols and blanks.

Part No. 87AC2046

Clear Window Overlays

Order separately from keyboards. See also ordering information.

- 3x4 Overlay **Part No. 88-101**
- 4x4 Overlay **Part No. 88-001**
- 5x4 Overlay **Part No. 88-201**

PRINTED LEGENDS

Not available through Distributors. For medium volume applications, or where legends cannot be produced by the self legend method, you can order epoxy ink printed legends. Virtually anything which can be photographed can be printed. Grayhill will print your legend and then add the clear window overlay.

Type I.D. No.	Simulated Style & Size	Character & Line Limitations *
4GH088	ABCDEFGH	END DATA
1GH125	ABCDE	LAD
3GH187	ABCD	ON
2GH250	ABC	15

ORDERING INFORMATION

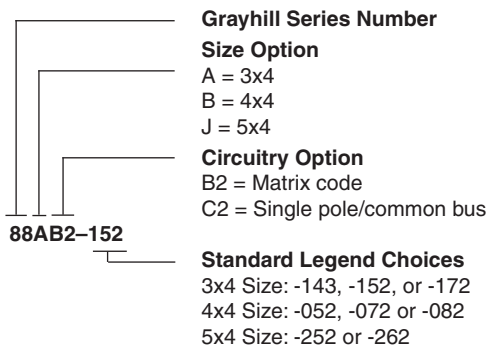

Available from your local Grayhill Distributor.

For prices and discounts, contact a local Sales Office, an authorized local Distributor or Grayhill.

Mouser Electronics

Authorized Distributor

Click to View Pricing, Inventory, Delivery & Lifecycle Information:

Grayhill:

[88-001](#) [88-052](#) [88-072](#) [88-101](#) [88-162](#) [88-201](#) [88AB2](#) [88AB2-143](#) [88AB2-152](#) [88AB2-172](#) [88BA2-072](#) [88BB2](#)
[88BB2-052](#) [88BB2-072](#) [88BB2-082](#) [88JB2](#) [88JB2-252](#) [88JB2-262](#) [88JC2](#) [88M2019-1](#) [88M2018-1](#) [88AC2](#) [88-262](#)
[88M2009-2](#) [88BC2-052](#) [88AC2-162](#) [88JC2-262](#) [88AA2-143](#) [88JC2-252](#) [88AC2-172](#) [88-172](#) [88-143](#) [88BC2-072](#)
[88M2001-2](#) [88AC2-182](#) [88BA2](#) [88BC2-082](#) [88M2012-2](#) [88AB2-162](#) [88AA2-152](#) [88-082](#) [88BC2](#) [88-152](#) [88AB2-](#)
[182](#) [88AC2-152](#) [88-252](#) [88AA2-172](#) [88M2015-1](#) [88AC2-143](#) [88BA2-052](#) [88M2012-1](#)