

THIS DRAWING IS UNPUBLISHED. RELEASED FOR PUBLICATION
 © COPYRIGHT - By - ALL RIGHTS RESERVED.

LOC	DIST	REVISIONS					
FT	0	P	LTR	DESCRIPTION	DATE	DWN	APVD
			B1	REVISED PER ECO-11-004587	11MAR11	RK	HMR

MATERIALS:
 HOUSING: POLYAMIDE, UL94V-0, BLACK.
 TERMINALS: COPPER ALLOY, TIN PLATED.
 SCREWS: STEEL, ZINC PLATED, UNLESS OTHERWISE STATED.

ELECTRICAL:
 RATING: 20A, UL & CSA.

MECHANICAL:
 WIRE RANGE: 12-22 AWG.
 MAXIMUM TIGHTENING TORQUE: 7 IN-LBS.

ENVIRONMENTAL:
 CONTINUOUS OPERATING TEMP.: -40°C TO +105°C

- ① PRELIMINARY PART NUMBER.
- ② SCREWS ARE NICKEL PLATED BRASS.

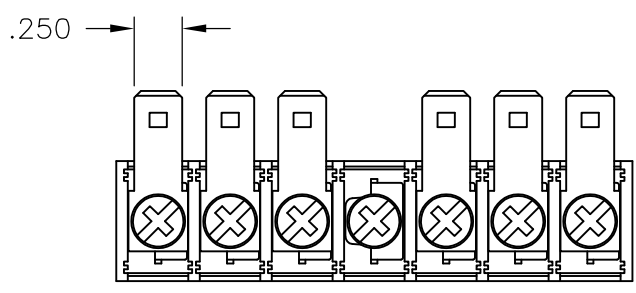
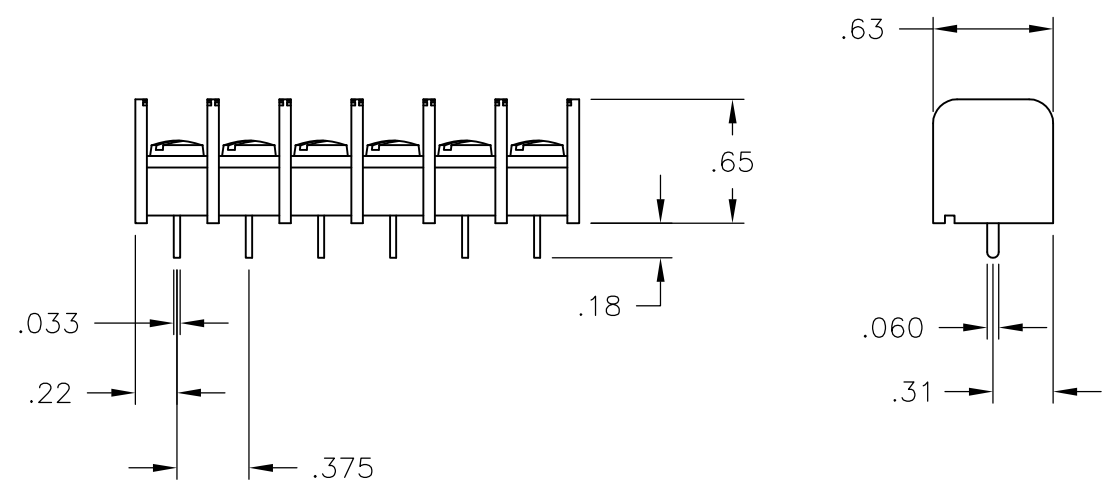
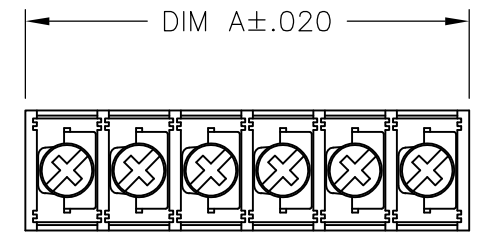

1546834-6

DIM A	NO OF POS	CATALOG NUMBER	PART NUMBER
9.059	24	NC6-P107-24	2-1437664-7
8.684	23	NC6-P107-23	1546834-4
8.309	22	NC6-P107-22	2-1437664-6
7.934	21	NC6-P107-21	1546834-3
7.559	20	NC6-P107-20	2-1437664-5
7.184	19	NC6-P107-19	1546834-2
6.809	18	NC6-P107-18	1546834-1
6.434	17	NC6-P107-17	2-1437664-3
6.059	16	NC6-P107-16	2-1437664-2
5.684	15	NC6-P107-15	2-1437664-1
5.309	14	NC6-P107-14	2-1437664-0
4.934	13	NC6-P107-13	1-1437664-8
①② 4.559	12	NC6-P105-12	1-1546834-0
①② 4.559	12	NC6-P107-12	1-1437664-7
①② 4.184	11	NC6-P105-11	1546834-9
①② 4.184	11	NC6-P107-11	1-1437664-6
①② 3.809	10	NC6-P105-10	1546834-8
①② 3.809	10	NC6-P107-10	1-1437664-4
①② 3.434	9	NC6-P107-09	1-1437664-3
①② 3.059	8	NC6-P105-08	1546834-7
①② 3.059	8	NC6-P107-08	1-1437664-1
① 2.684	7	NC6-P107-07-060	1546834-6
① 2.684	7	NC6-P107-07	1-1437664-0
2.309	6	NC6-P107-06	1437664-9
1.934	5	NC6-P107-05	1437664-7
1.559	4	NC6-P107-04	1437664-6
1.184	3	NC6-P107-03	1437664-5
.809	2	NC6-P107-02	1437664-4

THIS DRAWING IS A CONTROLLED DOCUMENT.		DWN S SCHLEGEL 8/17/04	TE Connectivity	
DIMENSIONS: INCHES		CHK S YODER 8/17/04		
TOLERANCES UNLESS OTHERWISE SPECIFIED:		APVD S YODER 8/17/04	NAME	
0 PLC ± -	1 PLC ± -	PRODUCT SPEC	NC6-P107-XX ASSEMBLY	
2 PLC ± .02	3 PLC ± .010	APPLICATION SPEC	SIZE	CAGE CODE
4 PLC ± -	ANGLES ± -	WEIGHT -	A3	00779
MATERIAL -	FINISH -	CUSTOMER DRAWING	DRAWING NO	RESTRICTED TO
			C-1437664-4	-
			SCALE NTS	SHEET 1 OF 1
			REV B1	

Mouser Electronics

Authorized Distributor

Click to View Pricing, Inventory, Delivery & Lifecycle Information:

[TE Connectivity:](#)

[NC6-P107-07](#)