

SERIES: P7805-S | **DESCRIPTION:** NON-ISOLATED SWITCHING REGULATOR

FEATURES

- up to 500 mA current output
- operating temperature range (-40~85°C)
- pin comparable to LM78 linear regulators
- wider input range
- suited for negative output applications
- low ripple and noise
- efficiency up to 96%



| MODEL | input voltage | | output voltage (Vdc) | output current max (mA) | output power max (W) | ripple and noise ¹ max (mVp-p) | efficiency typ (%) |
|------------------|---------------|----------------|-------------------------|-------------------------------|----------------------------|---|--------------------------|
| | typ (Vdc) | range (Vdc) | | | | | |
| P7805-Q12-S1R5-S | 12 | 4.75~28 | 1.5 | 500 | 0.75 | 30 | 77 |
| | 12 | 4.75~25 | -1.5 | -400 | 0.6 | 35 | 66 |
| P7805-Q12-S1R8-S | 12 | 4.75~28 | 1.8 | 500 | 0.90 | 30 | 81 |
| | 12 | 4.75~25 | -1.8 | -400 | 0.72 | 35 | 70 |
| P7805-Q12-S2-S | 12 | 4.75~28 | 2.5 | 500 | 1.25 | 30 | 87 |
| | 12 | 4.75~25 | -2.5 | -400 | 1.0 | 35 | 73 |
| P7805-Q24-S3-S | 24 | 4.75~28 | 3.3 | 500 | 1.65 | 30 | 91 |
| | 12 | 4.75~25 | -3.3 | -400 | 1.32 | 35 | 78 |
| P7805-Q24-S5-S | 24 | 6.5~32 | 5.0 | 500 | 2.5 | 30 | 94 |
| | 12 | 6.5~27 | -5.0 | -400 | 2 | 35 | 83 |
| P7805-Q24-S6-S | 24 | 8~32 | 6.5 | 500 | 3.25 | 30 | 94 |
| | 12 | 6.5~25 | -6.5 | -300 | 1.95 | 35 | 84 |
| P7805-Q24-S9-S | 24 | 11~32 | 9.0 | 500 | 4.5 | 30 | 95 |
| | 12 | 7.0~23 | -9.0 | -200 | 1.8 | 35 | 86 |
| P7805-Q24-S12-S | 24 | 15~32 | 12 | 500 | 6.0 | 30 | 95 |
| | 12 | 7.0~20 | -12 | -200 | 2.4 | 35 | 87 |
| P7805-Q24-S15-S | 24 | 18~32 | 15 | 500 | 7.5 | 30 | 96 |
| | 12 | 7~17 | -15 | -200 | 3.0 | 35 | 87 |

Notes: 1. ripple and noise are measured at 20 MHz BW

PART NUMBER KEY

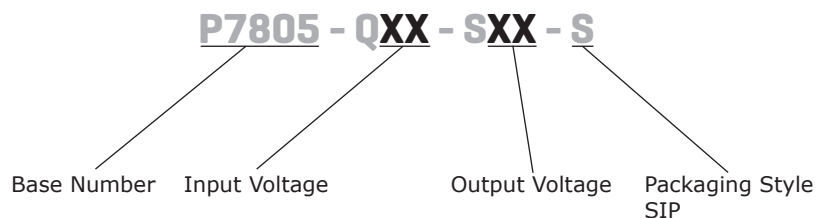

INPUT

| parameter | conditions/description | min | typ | max | units |
|-------------------------|---------------------------------|------|------|-------|-------|
| operating input voltage | -1.5, -1.8, -2.5, -3.3 V output | 4.75 | 12 | 25 | Vdc |
| | 1.5, 1.8, 2.5, V output | 4.75 | 12 | 28 | Vdc |
| | 3.3 V output | 4.75 | 24 | 28 | Vdc |
| | -5.0 V output | 6.5 | 12 | 27 | Vdc |
| | 5.0 V output | 6.5 | 24 | 32 | Vdc |
| | -6.5 V output | 6.5 | 12 | 25 | Vdc |
| | 6.5 V output | 8 | 24 | 32 | Vdc |
| | -9.0 V output | 7 | 12 | 23 | Vdc |
| | 9.0 V output | 11 | 24 | 32 | Vdc |
| | -12 V output | 7 | 12 | 20 | Vdc |
| | 12 V output | 15 | 24 | 32 | Vdc |
| | -15 V output | 7 | 12 | 17 | Vdc |
| | 15 V output | 18 | 24 | 32 | Vdc |
| no-load input power | input voltage range | | 0.12 | 0.256 | W |
| reverse polarity input | forbidden | | | | |
| filter | capacitance filter (1 μ F) | | | | |

OUTPUT

| parameter | conditions/description | min | typ | max | units |
|-------------------------|----------------------------------|-----|-----------|------------|---------|
| capacitive load | for positive output applications | | | 1,000 | μ F |
| | for negative output applications | | | 470 | μ F |
| line regulation | input voltage range | | ± 0.2 | ± 0.4 | % |
| load regulation | from 10% to 100% load | | ± 0.4 | ± 0.6 | % |
| voltage accuracy | 100% load, input voltage range | | ± 2 | ± 3 | % |
| switching frequency | 100% load, input voltage range | 280 | 330 | 450 | kHz |
| temperature coefficient | -40°C ~ 85°C | | | ± 0.02 | %/°C |

PROTECTIONS

| parameter | conditions/description | min | typ | max | units |
|-----------------------------|--------------------------------|-----|-----|-----|-------|
| short circuit protection | continuous, automatic recovery | | | | |
| short circuit input power | input voltage range | | 0.5 | 1.8 | W |
| over temperature protection | internal IC junction | | | 150 | °C |

SAFETY AND COMPLIANCE

| parameter | conditions/description | min | typ | max | units |
|------------------------------|--|-----------|-----|-----|-------|
| conducted emissions | CISPR22/EN55022 class B (external circuit required, see figure 1-b) | | | | |
| radiated emissions | CISPR22/EN55022 class B (external circuit required, see figure 1-b) | | | | |
| ESD | IEC/EN 61000-4-2 class B, contact ± 4 kV | | | | |
| radiated immunity | IEC/EN 61000-4-3 class A, 10V/m | | | | |
| EFT/burst | IEC/EN 61000-4-4 class B, ± 2 kV (external circuit required, see figure 1-a) | | | | |
| surge | IEC/EN 61000-4-5 class B, ± 2 kV (external circuit required, see figure 1-a) | | | | |
| conducted immunity | IEC/EN 61000-4-6 class A, 3 Vr.ms | | | | |
| voltage dips & interruptions | IEC/EN 61000-4-29 class B, 0%-70% | | | | |
| MTBF | as per MIL-HDBK-217F @ 25°C | 2,000,000 | | | hours |
| RoHS | 2011/65/EU | | | | |

ENVIRONMENTAL

| parameter | conditions/description | min | typ | max | units |
|-----------------------|-----------------------------------|-----|-----|-----|-------|
| operating temperature | see derating curve | -40 | | 85 | °C |
| storage temperature | | -55 | | 125 | °C |
| case temperature | operating temperature curve range | | | 100 | °C |
| storage humidity | non-condensing | | | 95 | % |

SOLDERABILITY

| parameter | conditions/description | min | typ | max | units |
|----------------|--------------------------------|-----|-----|-----|-------|
| hand soldering | 1.5mm from case for 10 seconds | | | 300 | °C |
| wave soldering | see wave soldering profile | | | 260 | °C |

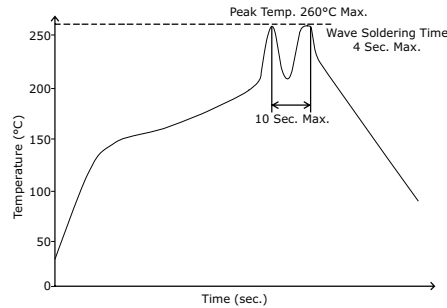

MECHANICAL

| parameter | conditions/description | min | typ | max | units |
|---------------|---|-----|-----|-----|-------|
| dimensions | 11.60 x 7.50 x 10.20 (0.457 x 0.295 x 0.402 inch) | | | | mm |
| case material | plastic (UL94-V0) | | | | |
| weight | | | 2.0 | | g |

MECHANICAL DRAWING

units: mm [inches]
 tolerance: ±0.25 [±0.010]
 pin section tolerance: ±0.10 mm [±0.004]

| PIN CONNECTIONS | | |
|-----------------|-----------------|-----------------|
| Pin | Positive Output | Negative Output |
| 1 | +Vin | +Vin |
| 2 | GND | -Vout |
| 3 | +Vout | GND |

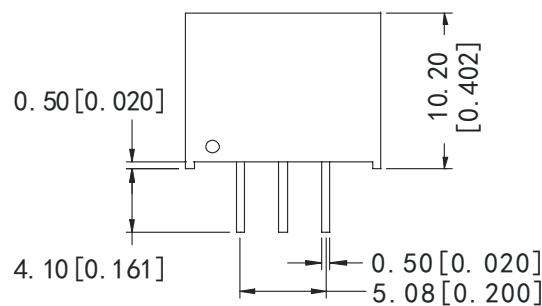

Front View

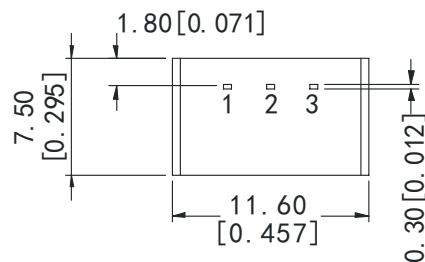

Bottom View

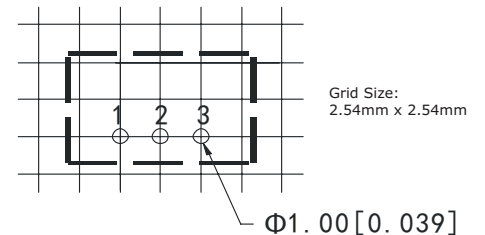

PCB Layout
Top View

DERATING CURVES

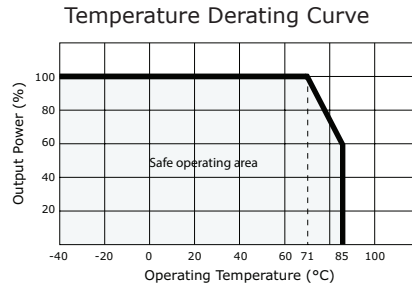

EMC RECOMMENDED CIRCUIT

Figure 1

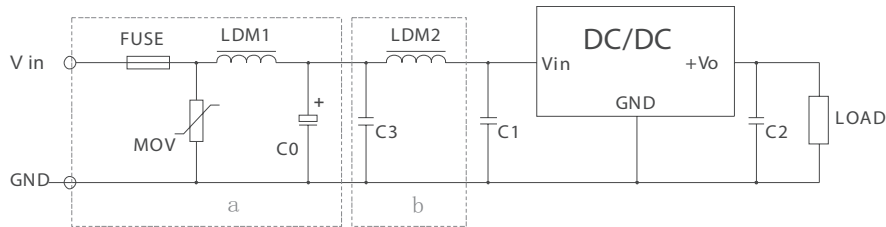

| Recommended external circuit components | |
|---|---|
| FUSE | choose according to practical input current |
| MOV | S10K35 |
| LDM1 | 82μH |
| LDM2 | 12μH |
| C0 | 680μF/50V |
| C3 | 4.7μF/50V |

Note: See External Capacitor Table on page 5 for C1 & C2 values.

TEST CONFIGURATION

Efficiency and Output Voltage Ripple Test

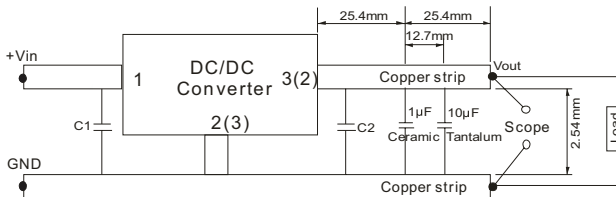

Start-up and Load Transient Response Test

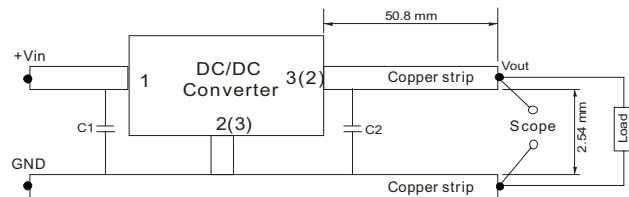

OUTPUT RIPPLE REDUCTION

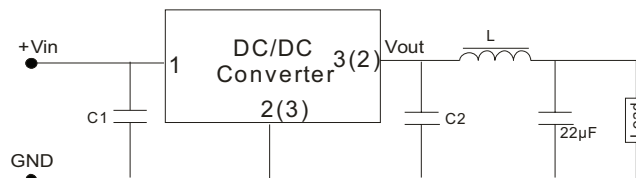

Note: To reduce ripple, it is recommended to add a LC filter in output port. (L: Recommended parameter 10μH ~ 47 μH)

TYPICAL APPLICATION CIRCUIT

Figure 2

Positive Output Application Circuit

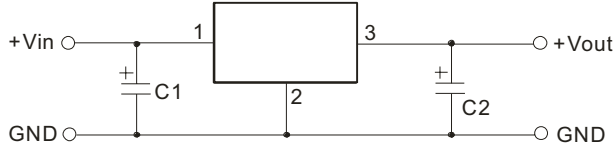

Figure 3

Negative Output Application Circuit

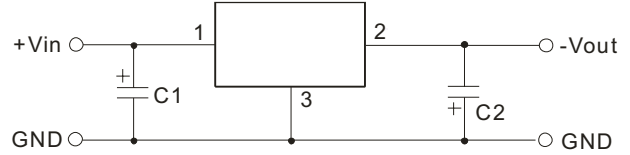
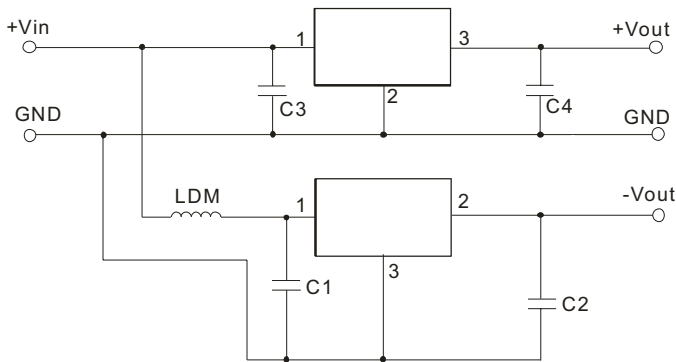

Figure 4

Positive and Negative Output Paralleling Application Circuit



External Capacitor Table

| Part Number | C1, C3 (ceramic capacitor) | C2, C4 (ceramic capacitor) |
|------------------|-------------------------------|-------------------------------|
| P7805-Q24-S1R5-S | 10 μ F/50V | 10 μ F/6.3V |
| P7805-Q24-S1R8-S | 10 μ F/50V | 10 μ F/6.3V |
| P7805-Q24-S2-S | 10 μ F/50V | 10 μ F/6.3V |
| P7805-Q24-S3-S | 10 μ F/50V | 10 μ F/6.3V |
| P7805-Q24-S5-S | 10 μ F/50V | 10 μ F/10V |
| P7805-Q24-S6-S | 10 μ F/50V | 10 μ F/16V |
| P7805-Q24-S9-S | 10 μ F/50V | 10 μ F/16V |
| P7805-Q24-S12-S | 10 μ F/50V | 10 μ F/25V |
| P7805-Q24-S15-S | 10 μ F/50V | 10 μ F/25V |

- Note:
1. When the products used as negative output and the input-voltage under ($V_{in-min}+2V$), C1 and C2 must be added in the circuit, and they should be placed as near as the products' footprints. Others apply to the application-environment.
 2. The capacitance of C1, C2, see external circuit table, can be increased if required, and tantalum or low ESR electrolytic capacitors may also suffice.
 3. When the products used as the circuit like figure 4, an inductor named as LDM up to 10 μ H is recommended in the circuit to reduce the mutual interference.
 4. For models $\leq 3.3 V_{OUT}$, if the input voltage of the model's negative output is less than 4.85 V, a dummy load of not less than 5 mA needs to be added to the output.
 5. Cannot use in parallel for output and hot swap for input.

- Note:
1. Max. capacitive load tested at input voltage range and full load.
 2. All specifications measured at: $T_a=25^\circ\text{C}$, humidity<75%, nominal input voltage and rated output load, unless otherwise specified.

REVISION HISTORY

| rev. | description | date |
|------|-------------------------------------|------------|
| 1.0 | initial release | 03/20/2013 |
| 1.01 | updated EMC circuit recommendations | 02/19/2015 |

The revision history provided is for informational purposes only and is believed to be accurate.



Headquarters
20050 SW 112th Ave.
Tualatin, OR 97062
800.275.4899

Fax 503.612.2383
cui.com
techsupport@cui.com

CUI offers a two (2) year limited warranty. Complete warranty information is listed on our website.

CUI reserves the right to make changes to the product at any time without notice. Information provided by CUI is believed to be accurate and reliable. However, no responsibility is assumed by CUI for its use, nor for any infringements of patents or other rights of third parties which may result from its use.

CUI products are not authorized or warranted for use as critical components in equipment that requires an extremely high level of reliability. A critical component is any component of a life support device or system whose failure to perform can be reasonably expected to cause the failure of the life support device or system, or to affect its safety or effectiveness.