

## FEATURES

**Low offset voltage: 13  $\mu\text{V}$  maximum**  
**Input offset drift: 0.03  $\mu\text{V}/^\circ\text{C}$**   
**Single-supply operation: 2.7 V to 5.5 V**  
**High gain, CMRR, and PSRR**  
**Low input bias current: 25 pA**  
**Low supply current: 180  $\mu\text{A}$**   
**Qualified for automotive applications**

## APPLICATIONS

**Mobile communications**  
**Portable instrumentation**  
**Battery-powered devices**  
**Sensor interfaces**  
**Temperature measurement**  
**Electronic scales**

## GENERAL DESCRIPTION

The AD8538/AD8539 are very high precision amplifiers featuring extremely low offset voltage, low input bias current, and low power consumption. The supply current is less than 215  $\mu\text{A}$  maximum per amplifier at 5.0 V. Operation is fully specified from 2.7 V to 5.0 V single supply ( $\pm 1.35$  V to  $\pm 2.5$  V dual supply).

The AD8538/AD8539 operate at very low power making these amplifiers ideal for battery-powered devices and portable equipment.

The AD8538/AD8539 are specified over the extended industrial temperature range ( $-40^\circ\text{C}$  to  $+125^\circ\text{C}$ ). The AD8538 amplifier is available in 5-lead TSOT-23, and 8-lead, narrow body SOIC packages, and the AD8539 amplifier is available in 8-lead, narrow body SOIC and 8-lead MSOP. See the Ordering Guide for the automotive part.

## PIN CONFIGURATIONS

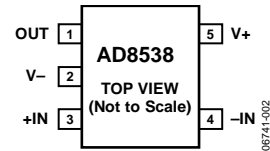

Figure 1. 5-Lead TSOT-23 (UJ-5)

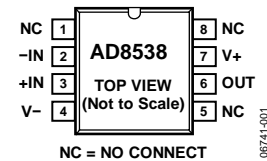

Figure 2. 8-Lead SOIC\_N (R-8)

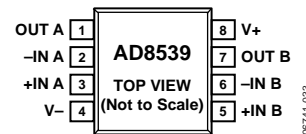

Figure 3. 8-Lead SOIC\_N (R-8)



Figure 4. 8-Lead MSOP (RM-8)

**TABLE OF CONTENTS**

Features .....	1	Absolute Maximum Ratings .....	7
Applications.....	1	Thermal Resistance.....	7
General Description .....	1	ESD Caution.....	7
Pin Configuration Diagrams.....	1	Typical Performance Characteristics .....	8
Revision History .....	2	AD8538 Characteristics.....	8
Specifications.....	3	AD8539 Characteristics.....	14
AD8538 Electrical Specifications .....	3	Outline Dimensions .....	20
AD8539 Electrical Specifications .....	5	Ordering Guide .....	21

**REVISION HISTORY**

**2/13—Rev. A to Rev. B**

Changes to Features Section and General Description Section ...	1
Updated Outline Dimensions .....	20
Changes to Ordering Guide .....	21
Added Automotive Products Section.....	21

**5/07—Rev. 0 to Rev. A**

Added AD8539 .....	Universal
Changes to Specifications Section .....	3
Added Table 3, Renumbered Tables Sequentially .....	5

Added Table 4, Renumbered Tables Sequentially .....	6
Changes to Thermal Resistance Section .....	7
Added Figure 32 and Figure 33 .....	13
Added AD8539 Characteristics Section, Renumbered Figures Sequentially .....	14
Updated Outline Dimensions .....	20
Changes to Ordering Guide .....	21

**10/05—Revision 0: Initial Version**

## SPECIFICATIONS

## AD8538 ELECTRICAL SPECIFICATIONS

@  $V_S = 5.0\text{ V}$ ,  $V_{CM} = 2.5\text{ V}$ ,  $V_O = 2.5\text{ V}$ ,  $T_A = 25^\circ\text{C}$ , unless otherwise specified.

Table 1.

Parameter	Symbol	Conditions	Min	Typ	Max	Unit
INPUT CHARACTERISTICS						
Offset Voltage	$V_{OS}$	$-40^\circ\text{C} \leq T_A \leq +125^\circ\text{C}$		5	13	$\mu\text{V}$
Input Bias Current	$I_B$	$-40^\circ\text{C} \leq T_A \leq +125^\circ\text{C}$			30	$\mu\text{V}$
		$-40^\circ\text{C} \leq T_A \leq +85^\circ\text{C}$		15	25	$\text{pA}$
Input Offset Current	$I_{OS}$	$-40^\circ\text{C} \leq T_A \leq +125^\circ\text{C}$		0.7	1.0	$\text{nA}$
		$-40^\circ\text{C} \leq T_A \leq +125^\circ\text{C}$		20	50	$\text{pA}$
Input Voltage Range					150	$\text{pA}$
Common-Mode Rejection Ratio	CMRR	$V_{CM} = 0\text{ V to } 5\text{ V}$ $-40^\circ\text{C} \leq T_A \leq +125^\circ\text{C}$ , $V_{CM} = 0.2\text{ V to } 4.8\text{ V}$	0		5	$\text{V}$
Large Signal Voltage Gain	$A_{VO}$	$R_L = 10\text{ k}\Omega$ , $V_O = 0.1\text{ V to } 4.9\text{ V}$	115	150		$\text{dB}$
		$-40^\circ\text{C} \leq T_A \leq +125^\circ\text{C}$	100	135		$\text{dB}$
Offset Voltage Drift	$\Delta V_{OS}/\Delta T$	$-40^\circ\text{C} \leq T_A \leq +125^\circ\text{C}$	110	135		$\text{dB}$
OUTPUT CHARACTERISTICS						
Output Voltage High	$V_{OH}$	$R_L = 100\text{ k}\Omega$ to ground	4.99	4.998		$\text{V}$
		$-40^\circ\text{C} \leq T_A \leq +125^\circ\text{C}$ , $R_L = 100\text{ k}\Omega$ to ground	4.98			$\text{V}$
		$R_L = 10\text{ k}\Omega$ to ground	4.95	4.970		$\text{V}$
		$-40^\circ\text{C} \leq T_A \leq +125^\circ\text{C}$ , $R_L = 10\text{ k}\Omega$ to ground	4.94			$\text{V}$
Output Voltage Low	$V_{OL}$	$R_L = 100\text{ k}\Omega$ to $V+$		1.9	5	$\text{mV}$
		$-40^\circ\text{C} \leq T_A \leq +125^\circ\text{C}$ , $R_L = 100\text{ k}\Omega$ to $V+$		2.8	7	$\text{mV}$
		$R_L = 10\text{ k}\Omega$ to $V+$		17	20	$\text{mV}$
		$-40^\circ\text{C} \leq T_A \leq +125^\circ\text{C}$ , $R_L = 10\text{ k}\Omega$ to $V+$		20	30	$\text{mV}$
Short-Circuit Limit	$I_{SC}$			$\pm 25$		$\text{mA}$
POWER SUPPLY						
Power Supply Rejection Ratio	PSRR	$V_S = 2.7\text{ V to } 5.0\text{ V}$	105	125		$\text{dB}$
		$-40^\circ\text{C} \leq T_A \leq +125^\circ\text{C}$	100	125		$\text{dB}$
Supply Current/Amplifier	$I_{SY}$	$I_O = 0$		150	180	$\mu\text{A}$
		$-40^\circ\text{C} \leq T_A \leq +125^\circ\text{C}$		190	215	$\mu\text{A}$
DYNAMIC PERFORMANCE						
Slew Rate	SR	$R_L = 10\text{ k}\Omega$		0.4		$\text{V}/\mu\text{s}$
Settling Time 0.01%	$t_s$	$G = \pm 1$ , $2\text{ V step}$ , $C_L = 20\text{ pF}$ , $R_L = 1\text{ k}\Omega$		10		$\mu\text{s}$
Overload Recovery Time				0.05		$\text{ms}$
Gain Bandwidth Product	GBP			430		$\text{kHz}$
Phase Margin	$\phi_M$	$R_L = 10\text{ k}\Omega$ , $R_L = 100\text{ k}\Omega$ , $C_L = 20\text{ pF}$		65		Degrees
NOISE PERFORMANCE						
Voltage Noise	$e_{n\text{ p-p}}$	$f = 0.1\text{ Hz to } 10\text{ Hz}$		2.0		$\mu\text{V p-p}$
Voltage Noise Density	$e_n$	$f = 1\text{ kHz}$		50		$\text{nV}/\sqrt{\text{Hz}}$

@  $V_S = 2.7\text{ V}$ ,  $V_{CM} = 1.35\text{ V}$ ,  $V_O = 1.35\text{ V}$ ,  $T_A = 25^\circ\text{C}$ , unless otherwise specified.

Table 2.

Parameter	Symbol	Conditions	Min	Typ	Max	Unit
<b>INPUT CHARACTERISTICS</b>						
Offset Voltage	$V_{OS}$	$-40^\circ\text{C} \leq T_A \leq +125^\circ\text{C}$		5	13	$\mu\text{V}$
Input Bias Current	$I_B$	$-40^\circ\text{C} \leq T_A \leq +125^\circ\text{C}$		15	25	$\text{pA}$
		$-40^\circ\text{C} \leq T_A \leq +85^\circ\text{C}$		35	100	$\text{pA}$
Input Offset Current	$I_{OS}$	$-40^\circ\text{C} \leq T_A \leq +125^\circ\text{C}$		0.7	1.0	$\text{nA}$
		$-40^\circ\text{C} \leq T_A \leq +125^\circ\text{C}$		20	50	$\text{pA}$
Input Voltage Range			0		2.7	$\text{V}$
Common-Mode Rejection Ratio	CMRR	$V_{CM} = 0\text{ V to } 2.5\text{ V}$ $-40^\circ\text{C} \leq T_A \leq +125^\circ\text{C}$	110	140		$\text{dB}$
Large Signal Voltage Gain	$A_{VO}$	$R_L = 10\text{ k}\Omega$ , $V_O = 0.1\text{ V to } 1.7\text{ V}$ $-40^\circ\text{C} \leq T_A \leq +125^\circ\text{C}$	110	140		$\text{dB}$
Offset Voltage Drift	$\Delta V_{OS}/\Delta T$	$-40^\circ\text{C} \leq T_A \leq +125^\circ\text{C}$		0.03	0.1	$\mu\text{V}/^\circ\text{C}$
<b>OUTPUT CHARACTERISTICS</b>						
Output Voltage High	$V_{OH}$	$R_L = 100\text{ k}\Omega$ to ground $-40^\circ\text{C} \leq T_A \leq +125^\circ\text{C}$ , $R_L = 100\text{ k}\Omega$ to ground	2.68	2.698		$\text{V}$
		$R_L = 10\text{ k}\Omega$ to ground $-40^\circ\text{C} \leq T_A \leq +125^\circ\text{C}$ , $R_L = 10\text{ k}\Omega$ to ground	2.68			$\text{V}$
		$R_L = 10\text{ k}\Omega$ to ground $-40^\circ\text{C} \leq T_A \leq +125^\circ\text{C}$ , $R_L = 10\text{ k}\Omega$ to ground	2.67	2.68		$\text{V}$
Output Voltage Low	$V_{OL}$	$R_L = 100\text{ k}\Omega$ to $V+$ $-40^\circ\text{C} \leq T_A \leq +125^\circ\text{C}$ , $R_L = 100\text{ k}\Omega$ to $V+$		1.7	5	$\text{mV}$
		$R_L = 10\text{ k}\Omega$ to $V+$ $-40^\circ\text{C} \leq T_A \leq +125^\circ\text{C}$ , $R_L = 10\text{ k}\Omega$ to $V+$		2.4	5	$\text{mV}$
		$R_L = 10\text{ k}\Omega$ to $V+$ $-40^\circ\text{C} \leq T_A \leq +125^\circ\text{C}$ , $R_L = 10\text{ k}\Omega$ to $V+$		14	20	$\text{mV}$
Short-Circuit Limit	$I_{SC}$	$-40^\circ\text{C} \leq T_A \leq +125^\circ\text{C}$ , $R_L = 10\text{ k}\Omega$ to $V+$		20	25	$\text{mV}$
				$\pm 8$		$\text{mA}$
<b>POWER SUPPLY</b>						
Power Supply Rejection Ratio	PSRR	$V_S = 2.7\text{ V to } 5.5\text{ V}$ $-40^\circ\text{C} \leq T_A \leq +125^\circ\text{C}$	105	125		$\text{dB}$
Supply Current/Amplifier	$I_{SY}$	$I_O = 0$ $-40^\circ\text{C} \leq T_A \leq +125^\circ\text{C}$		150	180	$\mu\text{A}$
				190	215	$\mu\text{A}$
<b>DYNAMIC PERFORMANCE</b>						
Slew Rate	SR	$R_L = 10\text{ k}\Omega$		0.35		$\text{V}/\mu\text{s}$
Settling Time 0.01%	$t_s$	$G = \pm 1$ , $1\text{ V step}$ , $C_L = 20\text{ pF}$ , $R_L = 1\text{ k}\Omega$		5		$\mu\text{s}$
Overload Recovery Time				0.05		$\text{ms}$
Gain Bandwidth Product	GBP			430		$\text{kHz}$
Phase Margin	$\phi_M$	$R_L = 10\text{ k}\Omega$ , $R_L = 100\text{ k}\Omega$ , $C_L = 20\text{ pF}$		65		Degrees
<b>NOISE PERFORMANCE</b>						
Voltage Noise	$e_{n\text{ p-p}}$	$f = 0.1\text{ Hz to } 10\text{ Hz}$		2.0		$\mu\text{V p-p}$
Voltage Noise Density	$e_n$	$f = 1\text{ kHz}$		50		$\text{nV}/\sqrt{\text{Hz}}$

**AD8539 ELECTRICAL SPECIFICATIONS**

@  $V_S = 5.0\text{ V}$ ,  $V_{CM} = 2.5\text{ V}$ ,  $V_O = 2.5\text{ V}$ ,  $T_A = 25^\circ\text{C}$ , unless otherwise specified.

Table 3.

Parameter	Symbol	Conditions	Min	Typ	Max	Unit
<b>INPUT CHARACTERISTICS</b>						
Offset Voltage	$V_{OS}$	$-40^\circ\text{C} \leq T_A \leq +125^\circ\text{C}$		5	15	$\mu\text{V}$
Input Bias Current	$I_B$	$-40^\circ\text{C} \leq T_A \leq +125^\circ\text{C}$			30	$\mu\text{V}$
		$-40^\circ\text{C} \leq T_A \leq +85^\circ\text{C}$		15	60	$\text{pA}$
Input Offset Current	$I_{OS}$	$-40^\circ\text{C} \leq T_A \leq +125^\circ\text{C}$		0.7	1.0	$\text{nA}$
		$-40^\circ\text{C} \leq T_A \leq +125^\circ\text{C}$		20	70	$\text{pA}$
Input Voltage Range		$-40^\circ\text{C} \leq T_A \leq +125^\circ\text{C}$	0		5	$\text{V}$
		$-40^\circ\text{C} \leq T_A \leq +125^\circ\text{C}$	0.2		4.8	$\text{V}$
Common-Mode Rejection Ratio	CMRR	$V_{CM} = 0\text{ V to } 5\text{ V}$	115	135		$\text{dB}$
		$-40^\circ\text{C} \leq T_A \leq +125^\circ\text{C}$ , $V_{CM} = 0.2\text{ V to } 4.8\text{ V}$	100	130		$\text{dB}$
Large Signal Voltage Gain	$A_{VO}$	$R_L = 10\text{ k}\Omega$ , $V_O = 0.1\text{ V to } 4.9\text{ V}$	110	130		$\text{dB}$
		$-40^\circ\text{C} \leq T_A \leq +125^\circ\text{C}$	110	125		$\text{dB}$
Offset Voltage Drift	$\Delta V_{OS}/\Delta T$	$-40^\circ\text{C} \leq T_A \leq +125^\circ\text{C}$		0.03	0.1	$\mu\text{V}/^\circ\text{C}$
<b>OUTPUT CHARACTERISTICS</b>						
Output Voltage High	$V_{OH}$	$R_L = 100\text{ k}\Omega$ to ground	4.99	4.994		$\text{V}$
		$-40^\circ\text{C} \leq T_A \leq +125^\circ\text{C}$ , $R_L = 100\text{ k}\Omega$ to ground	4.98			$\text{V}$
		$R_L = 10\text{ k}\Omega$ to ground	4.95	4.97		$\text{V}$
		$-40^\circ\text{C} \leq T_A \leq +125^\circ\text{C}$ , $R_L = 10\text{ k}\Omega$ to ground	4.94			$\text{V}$
Output Voltage Low	$V_{OL}$	$R_L = 100\text{ k}\Omega$ to $V_+$		5	7	$\text{mV}$
		$-40^\circ\text{C} \leq T_A \leq +125^\circ\text{C}$ , $R_L = 100\text{ k}\Omega$ to $V_+$		6	8	$\text{mV}$
		$R_L = 10\text{ k}\Omega$ to $V_+$		20	25	$\text{mV}$
		$-40^\circ\text{C} \leq T_A \leq +125^\circ\text{C}$ , $R_L = 10\text{ k}\Omega$ to $V_+$		24	30	$\text{mV}$
Short-Circuit Limit	$I_{SC}$			$\pm 25$		$\text{mA}$
<b>POWER SUPPLY</b>						
Power Supply Rejection Ratio	PSRR	$V_S = 2.7\text{ V to } 5.0\text{ V}$	105	125		$\text{dB}$
		$-40^\circ\text{C} \leq T_A \leq +125^\circ\text{C}$	100	125		$\text{dB}$
Supply Current/Amplifier	$I_{SY}$	$I_O = 0$		170	210	$\mu\text{A}$
		$-40^\circ\text{C} \leq T_A \leq +125^\circ\text{C}$			225	$\mu\text{A}$
<b>DYNAMIC PERFORMANCE</b>						
Slew Rate	SR	$R_L = 10\text{ k}\Omega$		0.4		$\text{V}/\mu\text{s}$
Settling Time 0.01%	$t_s$	$G = \pm 1$ , $2\text{ V step}$ , $C_L = 20\text{ pF}$ , $R_L = 1\text{ k}\Omega$		10		$\mu\text{s}$
Overload Recovery Time				0.05		$\text{ms}$
Gain Bandwidth Product	GBP			430		$\text{kHz}$
Phase Margin	$\phi_M$	$R_L = 10\text{ k}\Omega$ , $R_L = 100\text{ k}\Omega$ , $C_L = 20\text{ pF}$		65		Degrees
<b>NOISE PERFORMANCE</b>						
Voltage Noise	$e_{n\text{ p-p}}$	$f = 0.1\text{ Hz to } 10\text{ Hz}$		1.2		$\mu\text{V p-p}$
Voltage Noise Density	$e_n$	$f = 1\text{ kHz}$		52		$\text{nV}/\sqrt{\text{Hz}}$

@  $V_S = 2.7\text{ V}$ ,  $V_{CM} = 1.35\text{ V}$ ,  $V_O = 1.35\text{ V}$ ,  $T_A = 25^\circ\text{C}$ , unless otherwise specified.

Table 4.

Parameter	Symbol	Conditions	Min	Typ	Max	Unit
<b>INPUT CHARACTERISTICS</b>						
Offset Voltage	$V_{OS}$	$-40^\circ\text{C} \leq T_A \leq +125^\circ\text{C}$		5	16	$\mu\text{V}$
Input Bias Current	$I_B$	$-40^\circ\text{C} \leq T_A \leq +125^\circ\text{C}$		15	25	$\text{pA}$
		$-40^\circ\text{C} \leq T_A \leq +85^\circ\text{C}$		35	125	$\text{pA}$
Input Offset Current	$I_{OS}$	$-40^\circ\text{C} \leq T_A \leq +125^\circ\text{C}$		0.7	1.0	$\text{nA}$
		$-40^\circ\text{C} \leq T_A \leq +125^\circ\text{C}$		20	50	$\text{pA}$
Input Voltage Range		$-40^\circ\text{C} \leq T_A \leq +125^\circ\text{C}$	0		2.7	$\text{V}$
Common-Mode Rejection Ratio	CMRR	$-40^\circ\text{C} \leq T_A \leq +125^\circ\text{C}$ $V_{CM} = 0\text{ V to } 2.7\text{ V}$	0.2	130	2.5	$\text{dB}$
Large Signal Voltage Gain	$A_{VO}$	$-40^\circ\text{C} \leq T_A \leq +125^\circ\text{C}$ , $V_{CM} = 0.2\text{ V to } 2.5\text{ V}$ $R_L = 10\text{ k}\Omega$ , $V_O = 0.1\text{ V to } 2.6\text{ V}$	110	125		$\text{dB}$
		$-40^\circ\text{C} \leq T_A \leq +125^\circ\text{C}$	110	130		$\text{dB}$
Offset Voltage Drift	$\Delta V_{OS}/\Delta T$	$-40^\circ\text{C} \leq T_A \leq +125^\circ\text{C}$		0.03	0.1	$\mu\text{V}/^\circ\text{C}$
<b>OUTPUT CHARACTERISTICS</b>						
Output Voltage High	$V_{OH}$	$R_L = 100\text{ k}\Omega$ to ground $-40^\circ\text{C} \leq T_A \leq +125^\circ\text{C}$ , $R_L = 100\text{ k}\Omega$ to ground	2.68	2.693		$\text{V}$
		$R_L = 10\text{ k}\Omega$ to ground $-40^\circ\text{C} \leq T_A \leq +125^\circ\text{C}$ , $R_L = 10\text{ k}\Omega$ to ground	2.68			$\text{V}$
		$R_L = 10\text{ k}\Omega$ to ground $-40^\circ\text{C} \leq T_A \leq +125^\circ\text{C}$ , $R_L = 10\text{ k}\Omega$ to ground	2.67	2.68		$\text{V}$
		$R_L = 10\text{ k}\Omega$ to ground $-40^\circ\text{C} \leq T_A \leq +125^\circ\text{C}$ , $R_L = 10\text{ k}\Omega$ to ground	2.66			$\text{V}$
Output Voltage Low	$V_{OL}$	$R_L = 100\text{ k}\Omega$ to $V+$ $-40^\circ\text{C} \leq T_A \leq +125^\circ\text{C}$ , $R_L = 100\text{ k}\Omega$ to $V+$		5	7	$\text{mV}$
		$R_L = 10\text{ k}\Omega$ to $V+$ $-40^\circ\text{C} \leq T_A \leq +125^\circ\text{C}$ , $R_L = 10\text{ k}\Omega$ to $V+$		6	8	$\text{mV}$
		$R_L = 10\text{ k}\Omega$ to $V+$ $-40^\circ\text{C} \leq T_A \leq +125^\circ\text{C}$ , $R_L = 10\text{ k}\Omega$ to $V+$		14	20	$\text{mV}$
Short-Circuit Limit	$I_{SC}$	$-40^\circ\text{C} \leq T_A \leq +125^\circ\text{C}$ , $R_L = 10\text{ k}\Omega$ to $V+$		20	25	$\text{mV}$
				$\pm 8$		$\text{mA}$
<b>POWER SUPPLY</b>						
Power Supply Rejection Ratio	PSRR	$V_S = 2.7\text{ V to } 5.5\text{ V}$ $-40^\circ\text{C} \leq T_A \leq +125^\circ\text{C}$	105	125		$\text{dB}$
			100	125		$\text{dB}$
Supply Current/Amplifier	$I_{SY}$	$I_O = 0$ $-40^\circ\text{C} \leq T_A \leq +125^\circ\text{C}$			210	$\mu\text{A}$
					225	$\mu\text{A}$
<b>DYNAMIC PERFORMANCE</b>						
Slew Rate	SR	$R_L = 10\text{ k}\Omega$		0.35		$\text{V}/\mu\text{s}$
Settling Time 0.01%	$t_s$	$G = \pm 1$ , $1\text{ V step}$ , $C_L = 20\text{ pF}$ , $R_L = \infty$		8		$\mu\text{s}$
Overload Recovery Time				0.05		$\text{ms}$
Gain Bandwidth Product	GBP			430		$\text{kHz}$
Phase Margin	$\phi_M$	$R_L = 10\text{ k}\Omega$ , $R_L = 100\text{ k}\Omega$ , $C_L = 20\text{ pF}$		65		Degrees
<b>NOISE PERFORMANCE</b>						
Voltage Noise	$e_{n\text{ p-p}}$	$f = 0.1\text{ Hz to } 10\text{ Hz}$		2.0		$\mu\text{V p-p}$
Voltage Noise Density	$e_n$	$f = 1\text{ kHz}$		55		$\text{nV}/\sqrt{\text{Hz}}$

## ABSOLUTE MAXIMUM RATINGS

$T_A = 25^\circ\text{C}$ , unless otherwise noted.

Table 5.

Parameter	Rating
Supply Voltage	+6 V
Input Voltage	$V_{SS} - 0.3\text{ V}$ to $V_{DD} + 0.3\text{ V}$
Differential Input Voltage	$\pm 6\text{ V}$
Output Short-Circuit Duration to GND	Observe derating curve
Storage Temperature Range	$-65^\circ\text{C}$ to $+150^\circ\text{C}$
Lead Temperature (Soldering, 60 sec)	$300^\circ\text{C}$
Operating Temperature Range	$-40^\circ\text{C}$ to $+125^\circ\text{C}$
Junction Temperature Range	$-65^\circ\text{C}$ to $+150^\circ\text{C}$

Stresses above those listed under Absolute Maximum Ratings may cause permanent damage to the device. This is a stress rating only; functional operation of the device at these or any other conditions above those indicated in the operational section of this specification is not implied. Exposure to absolute maximum rating conditions for extended periods may affect device reliability.

Absolute maximum ratings apply at  $25^\circ\text{C}$ , unless otherwise noted.

## THERMAL RESISTANCE

$\theta_{JA}$  is specified for the worst-case conditions, that is, a device soldered in a circuit board for surface-mount packages.

Table 6. Thermal Characteristics

Package Type	$\theta_{JA}$	$\theta_{JC}$	Unit
5-Lead TSOT-23 (UJ-5)	207	61	$^\circ\text{C}/\text{W}$
8-Lead SOIC_N (R-8)	125	43	$^\circ\text{C}/\text{W}$
8-Lead MSOP (RM-8)	145	45	$^\circ\text{C}/\text{W}$

## ESD CAUTION



### ESD (electrostatic discharge) sensitive device.

Charged devices and circuit boards can discharge without detection. Although this product features patented or proprietary protection circuitry, damage may occur on devices subjected to high energy ESD. Therefore, proper ESD precautions should be taken to avoid performance degradation or loss of functionality.

# TYPICAL PERFORMANCE CHARACTERISTICS

## AD8538 CHARACTERISTICS

AD8538 only,  $V_{SY} = 5\text{ V}$  or  $\pm 2.5\text{ V}$ , unless otherwise noted.



Figure 5. AD8538 Input Offset Voltage Distribution



Figure 8. AD8538 Input Bias Current vs. Temperature

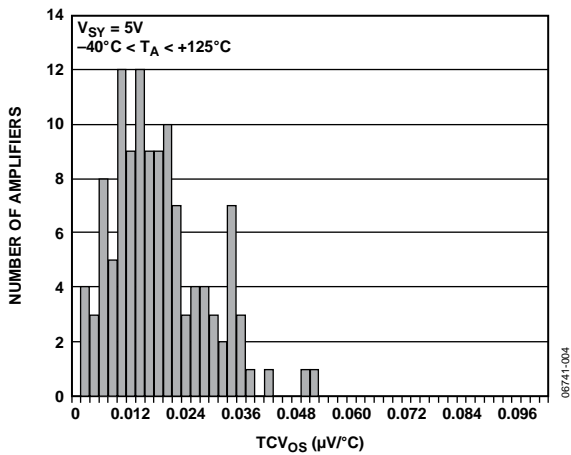

Figure 6. AD8538 Input Offset Voltage Drift Distribution

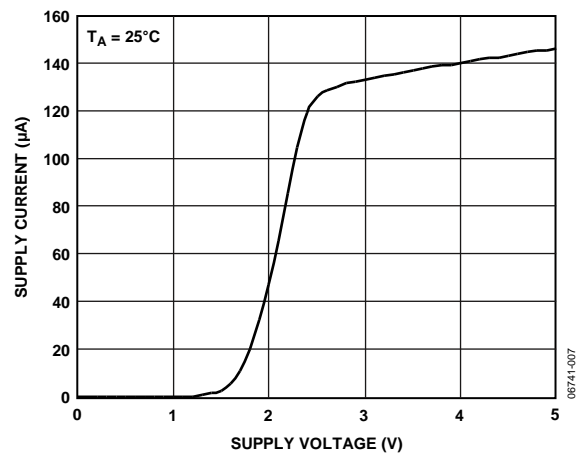

Figure 9. AD8538 Supply Current vs. Supply Voltage

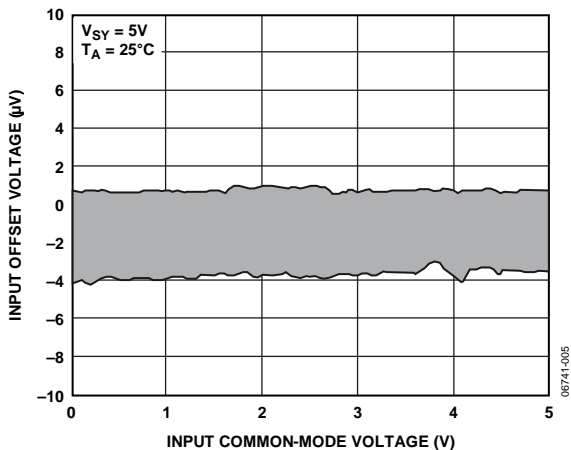

Figure 7. AD8538 Input Offset Voltage vs. Input Common-Mode Voltage

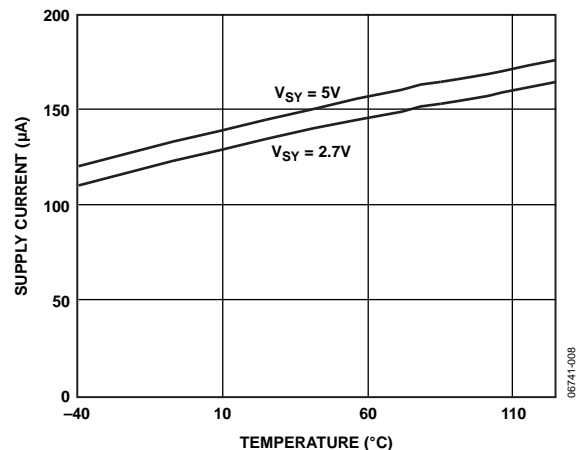

Figure 10. AD8538 Supply Current vs. Temperature



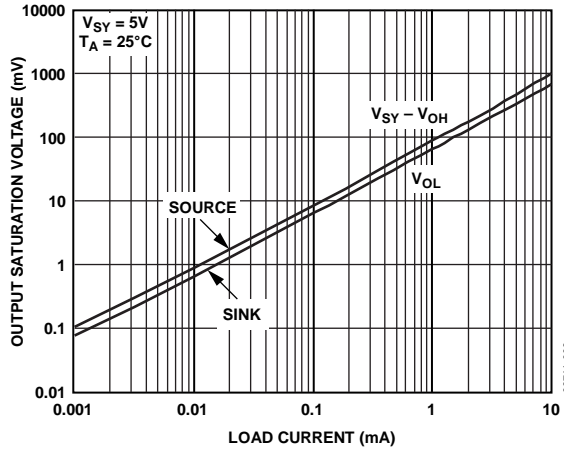

Figure 11. AD8538 Output Saturation Voltage vs. Load Current



Figure 14. AD8538 Open-Loop Gain and Phase vs. Frequency

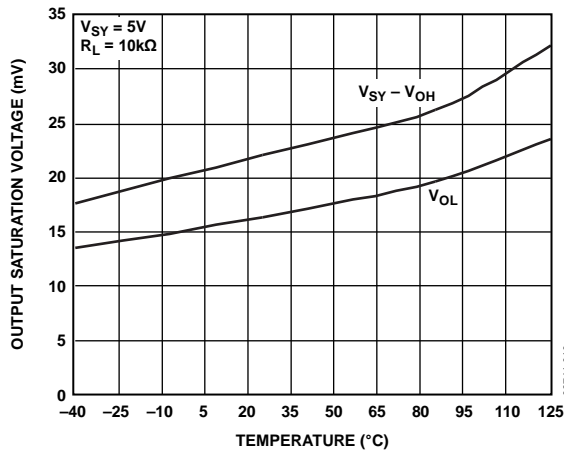

Figure 12. AD8538 Output Saturation Voltage vs. Temperature



Figure 15. AD8538 CMRR vs. Frequency

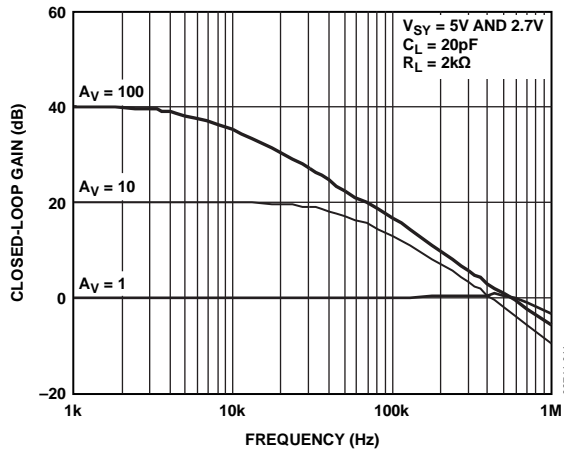

Figure 13. AD8538 Closed-Loop Gain vs. Frequency



Figure 16. AD8538 PSRR vs. Frequency



Figure 17. AD8538 Closed-Loop Output Impedance vs. Frequency



Figure 20. AD8538 Large Signal Transient Response

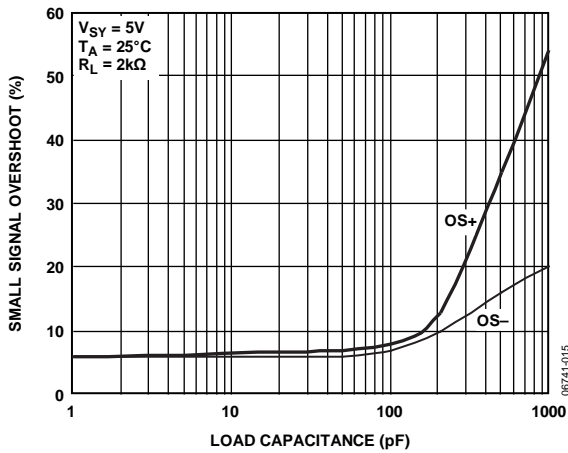

Figure 18. AD8538 Small Signal Overshoot vs. Load Capacitance

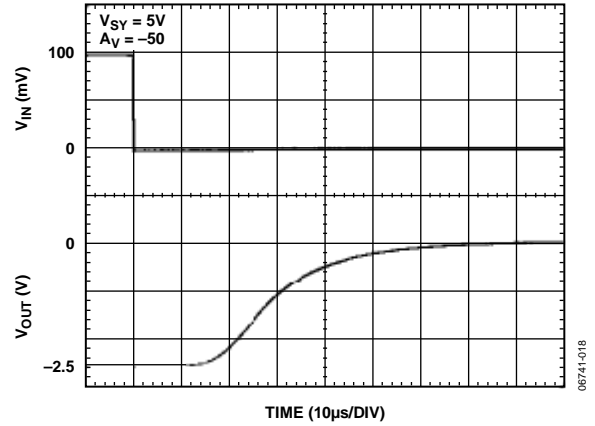

Figure 21. AD8538 Positive Overload Recovery

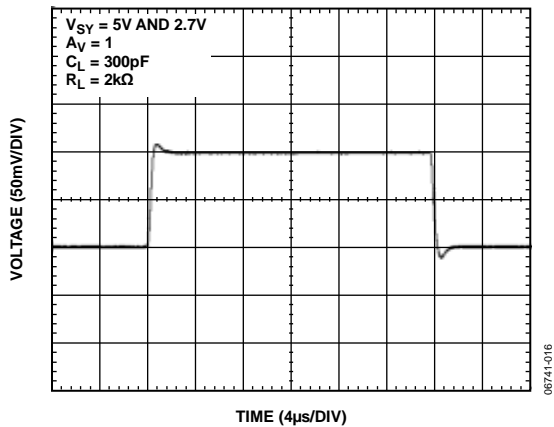

Figure 19. AD8538 Small Signal Transient Response

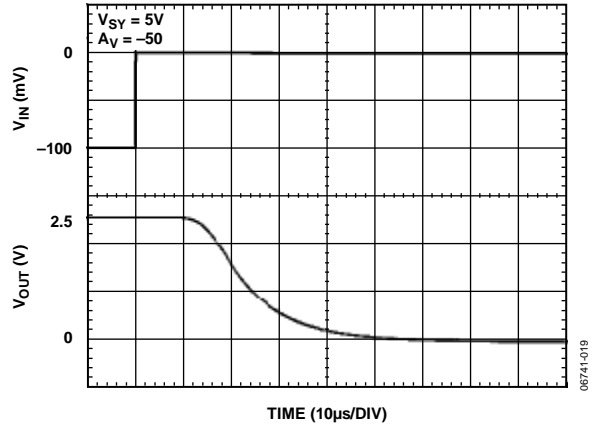

Figure 22. AD8538 Negative Overload Recovery



Figure 23. AD8538 Voltage Noise Density

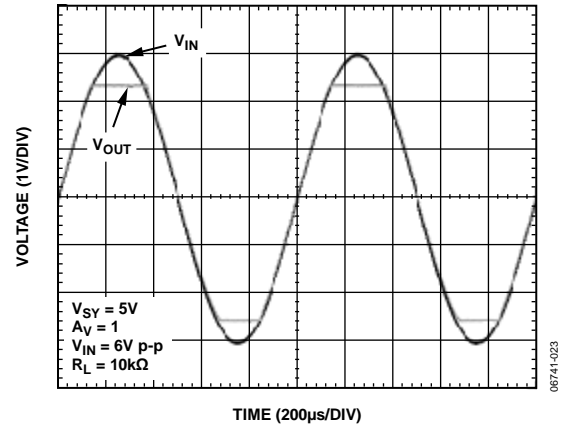

Figure 25. AD8538 No Phase Reversal



Figure 24. AD8538 0.1 Hz to 10 Hz Input Voltage Noise

$V_{SY} = 2.7\text{ V}$  or  $\pm 1.35\text{ V}$ , AD8538 only, unless otherwise noted.

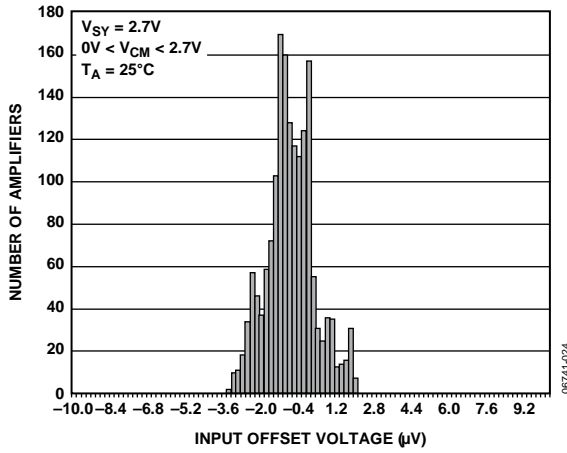

Figure 26. AD8538 Input Offset Voltage Distribution

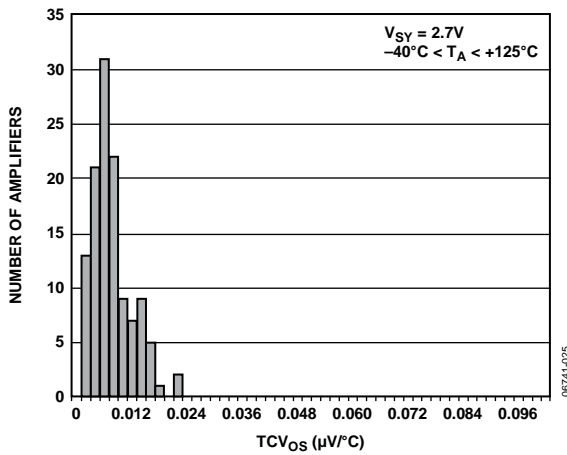

Figure 27. AD8538 Input Offset Voltage Drift Distribution



Figure 28. AD8538 Input Offset Voltage vs. Input Common-Mode Voltage

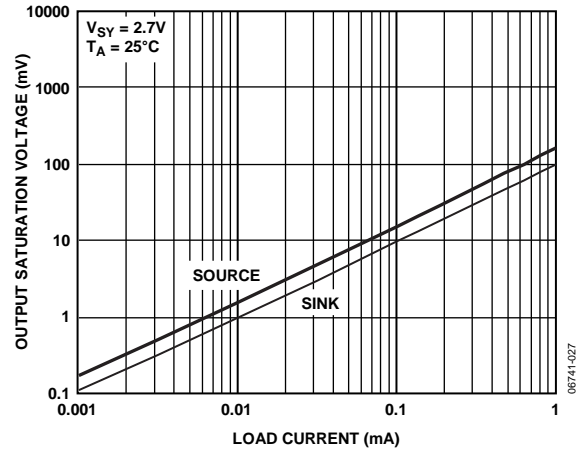

Figure 29. AD8538 Output Saturation Voltage vs. Load Current

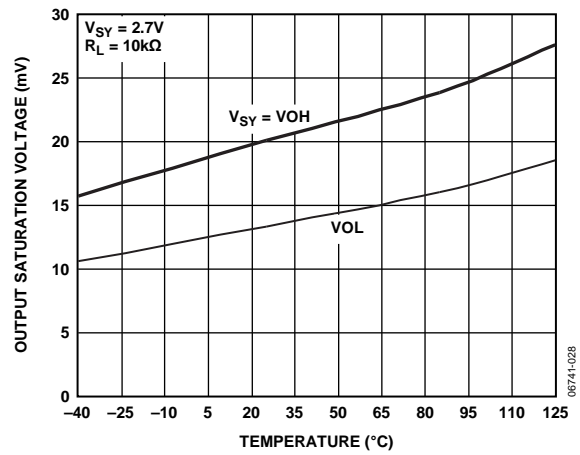

Figure 30. AD8538 Output Saturation Voltage vs. Temperature



Figure 31. AD8538 Small Signal Overshoot vs. Load Capacitance



Figure 32. AD8538 Large Signal Transient Response



Figure 33. AD8538 Voltage Noise Density

AD8539 CHARACTERISTICS

AD8539 only,  $V_S = 5\text{ V}$  or  $\pm 2.5\text{ V}$ , unless otherwise noted.

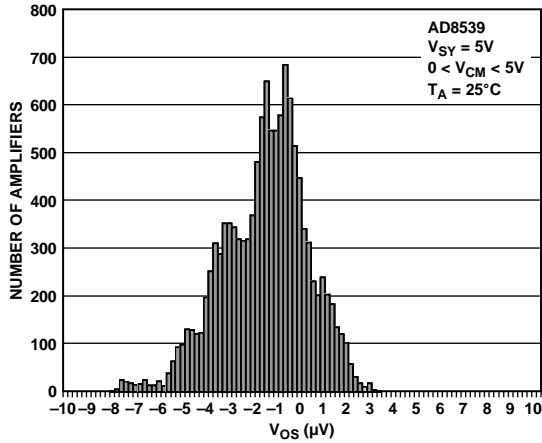

Figure 34. AD8539 Input Offset Voltage Distribution

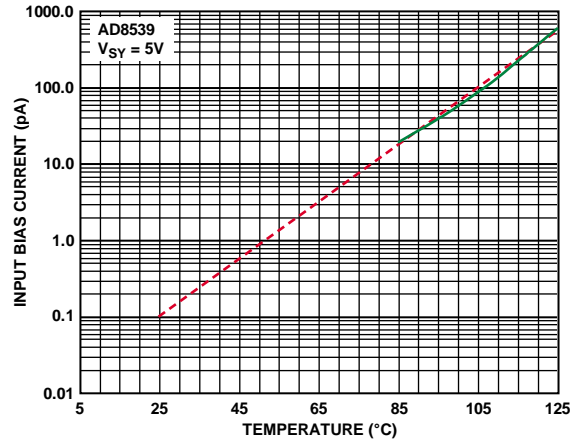

Figure 37. AD8539 Input Bias Current vs. Temperature

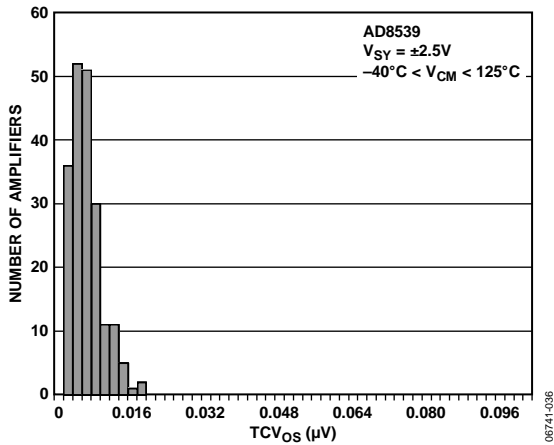

Figure 35. AD8539 Input Offset Voltage Drift Distribution

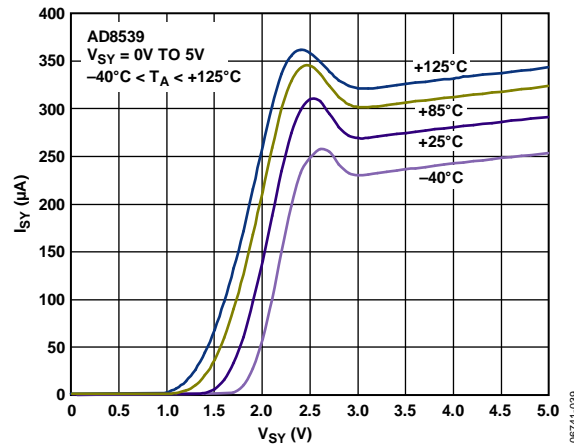

Figure 38. AD8539 Supply Current vs. Supply Voltage

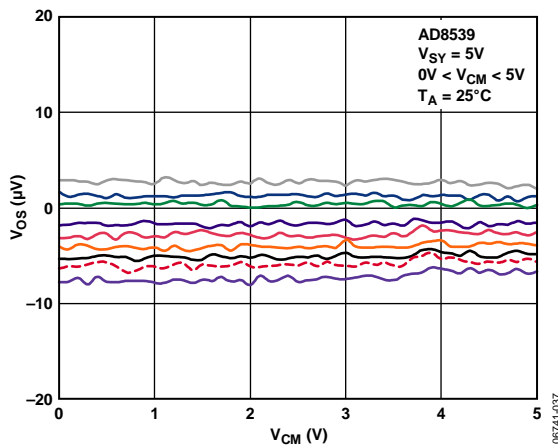

Figure 36. AD8539 Input Offset Voltage vs. Input Common-Mode Voltage

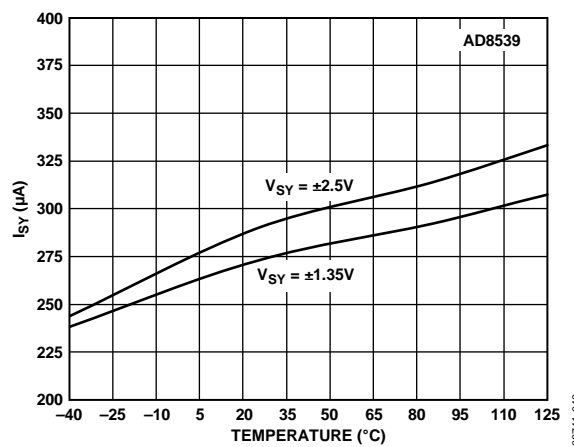

Figure 39. AD8539 Supply Current vs. Temperature



Figure 40. AD8539 Output Saturation Voltage vs. Load Current



Figure 43. AD8539 Open-Loop Gain and Phase vs. Frequency



Figure 41. AD8539 Output Saturation Voltage vs. Temperature



Figure 44. AD8539 CMRR vs. Frequency



Figure 42. AD8539 Closed-Loop Gain vs. Frequency



Figure 45. AD8539 PSRR vs. Frequency



Figure 46. AD8539 Closed-Loop Output Impedance vs. Frequency



Figure 49. AD8539 Large Signal Transient Response



Figure 47. AD8539 Small Signal Overshoot vs. Load Capacitance



Figure 50. AD8539 Positive Overload Recovery



Figure 48. AD8539 Small Signal Transient Response

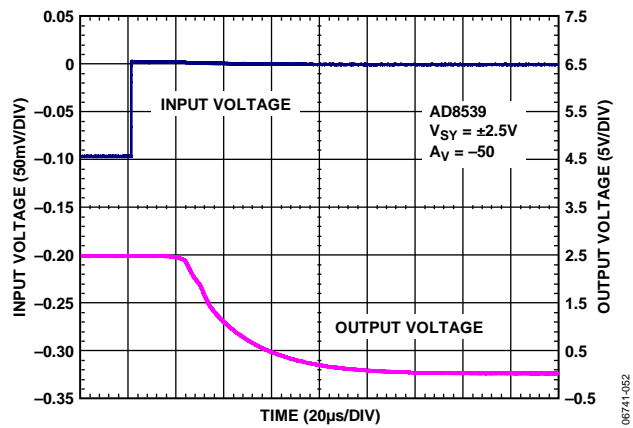

Figure 51. AD8539 Negative Overload Recovery





Figure 52. AD8539 Voltage Noise Density



Figure 54. AD8539 No Phase Reversal



Figure 53. AD8539 0.1 Hz to 10 Hz Input Voltage Noise



Figure 55. AD8539 Channel Separation vs. Frequency

$V_S = 2.7\text{ V}$  or  $\pm 1.35\text{ V}$ ,  $T_A = 25^\circ\text{C}$ , AD8539 only, unless otherwise noted.

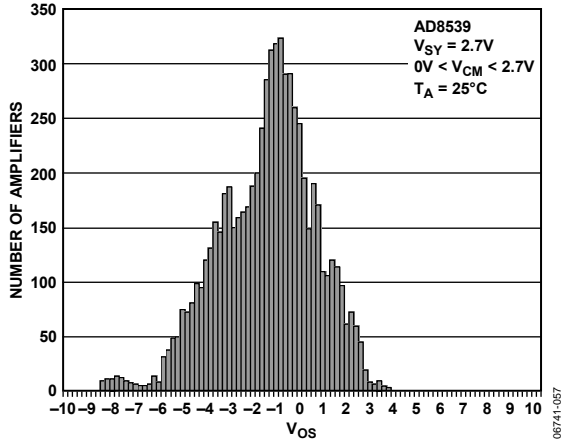

Figure 56. AD8539 Input Offset Voltage Distribution

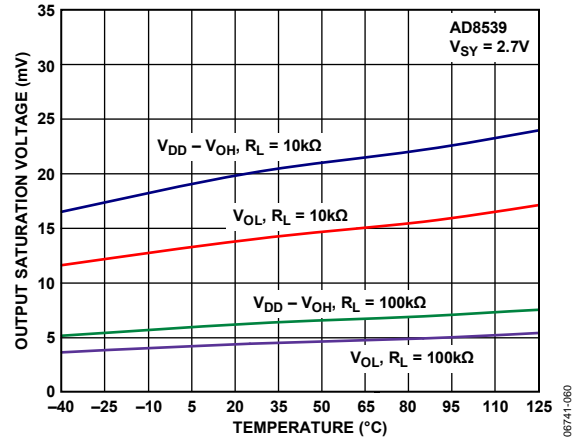

Figure 59. AD8539 Output Saturation Voltage vs. Temperature

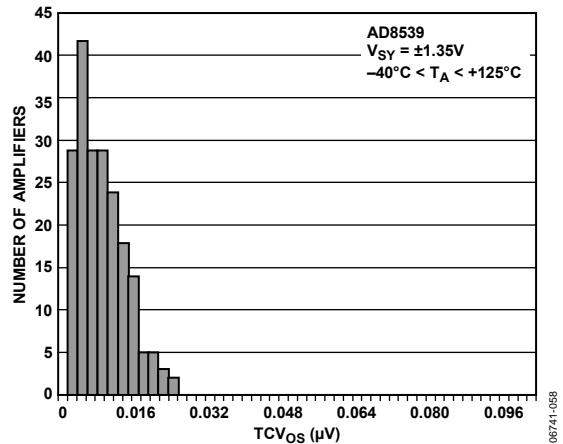

Figure 57. AD8539 Input Offset Voltage Drift Distribution

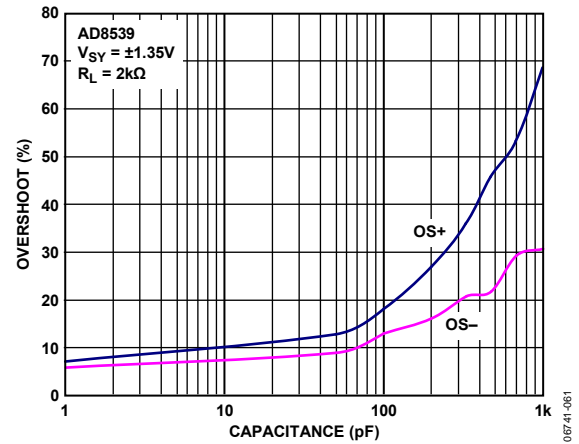

Figure 60. AD8539 Small Signal Overshoot vs. Load Capacitance

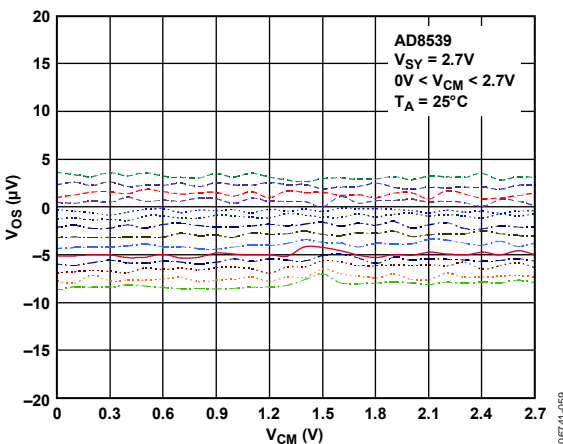

Figure 58. AD8539 Input Offset Voltage vs. Input Common-Mode Voltage

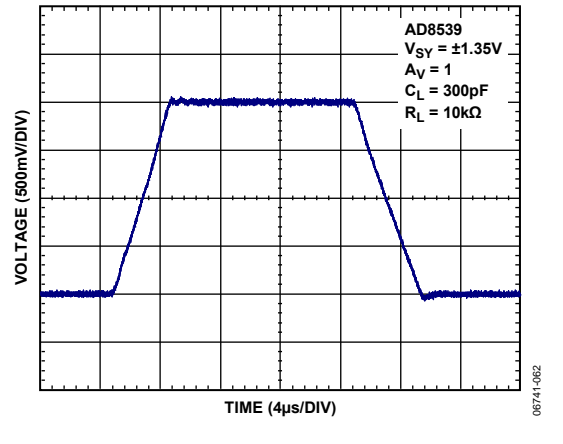

Figure 61. AD8539 Large Signal Transient Response



Figure 62. AD8539 Voltage Noise Density

06741-063

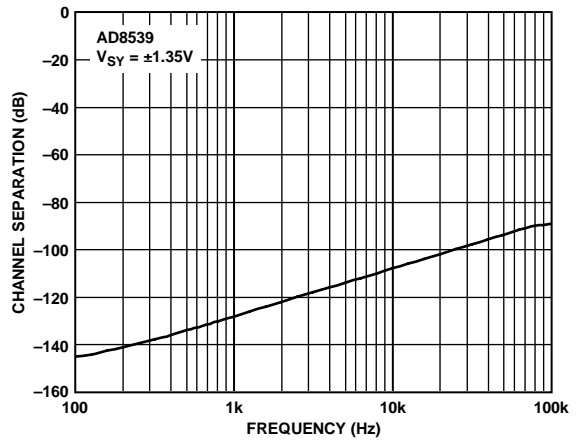
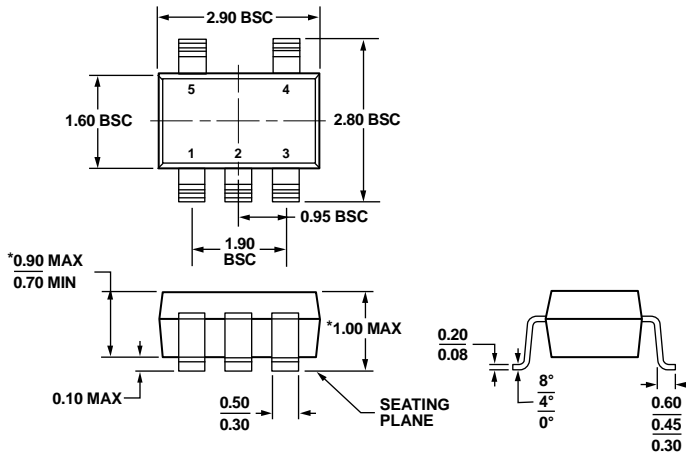

Figure 63. AD8539 Channel Separation vs. Frequency

06741-064

OUTLINE DIMENSIONS



\*COMPLIANT TO JEDEC STANDARDS MO-193-AB WITH THE EXCEPTION OF PACKAGE HEIGHT AND THICKNESS.

Figure 64. 5-Lead Thin Small Outline Transistor Package [TSOT-23] (UJ-5)

Dimensions shown in millimeters

100708-A

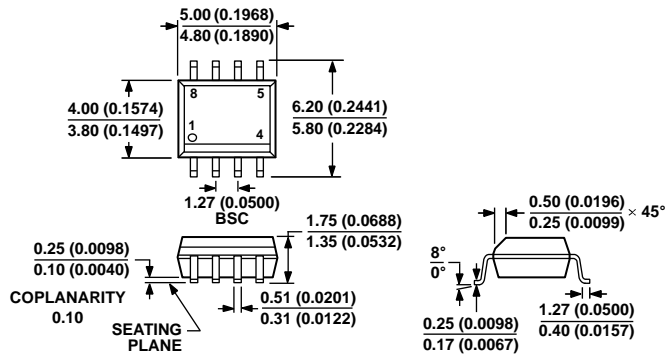

COMPLIANT TO JEDEC STANDARDS MS-012-AA CONTROLLING DIMENSIONS ARE IN MILLIMETERS; INCH DIMENSIONS (IN PARENTHESES) ARE ROUNDED-OFF MILLIMETER EQUIVALENTS FOR REFERENCE ONLY AND ARE NOT APPROPRIATE FOR USE IN DESIGN.

Figure 65. 8-Lead Standard Small Outline Package [SOIC\_N] Narrow Body (R-8)

Dimensions shown in millimeters and (inches)

012407-A

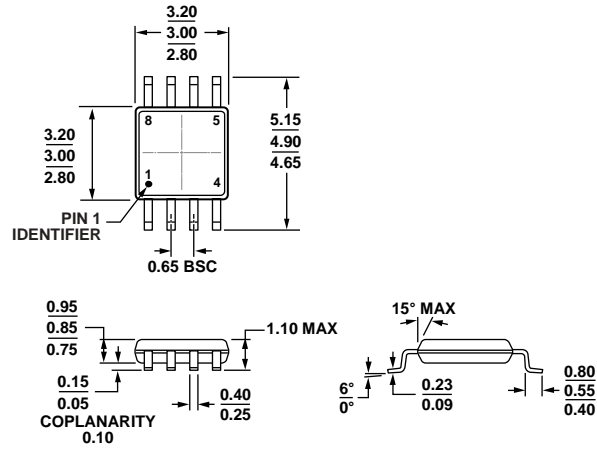

COMPLIANT TO JEDEC STANDARDS MO-187-AA  
 Figure 66. 8-Lead Mini Small Outline Package [MSOP]  
 (RM-8)  
 Dimensions shown in millimeters

16-07-2008B

**ORDERING GUIDE**

Model <sup>1,2</sup>	Temperature Range	Package Description	Package Option	Branding
AD8538AUJZ-R2	-40°C to +125°C	5-Lead TSOT-23	UJ-5	A0C
AD8538AUJZ-REEL	-40°C to +125°C	5-Lead TSOT-23	UJ-5	A0C
AD8538AUJZ-REEL7	-40°C to +125°C	5-Lead TSOT-23	UJ-5	A0C
AD8538WUJZ-R7	-40°C to +125°C	5-Lead TSOT-23	UJ-5	A0C
AD8538ARZ	-40°C to +125°C	8-Lead SOIC_N	R-8	
AD8538ARZ-REEL	-40°C to +125°C	8-Lead SOIC_N	R-8	
AD8538ARZ-REEL7	-40°C to +125°C	8-Lead SOIC_N	R-8	
AD8539ARMZ	-40°C to +125°C	8-Lead MSOP	RM-8	A1S
AD8539ARMZ-REEL	-40°C to +125°C	8-Lead MSOP	RM-8	A1S
AD8539ARZ	-40°C to +125°C	8-Lead SOIC_N	R-8	
AD8539ARZ-REEL	-40°C to +125°C	8-Lead SOIC_N	R-8	
AD8539ARZ-REEL7	-40°C to +125°C	8-Lead SOIC_N	R-8	

<sup>1</sup> Z = RoHS Compliant Part.

<sup>2</sup> W = Qualified for Automotive Applications.

**AUTOMOTIVE PRODUCTS**

The AD8538W model is available with controlled manufacturing to support the quality and reliability requirements of automotive applications. Note that this automotive model may have specifications that differ from the commercial models; therefore, designers should review the Specifications section of this data sheet carefully. Only the automotive grade products shown are available for use in automotive applications. Contact your local Analog Devices account representative for specific product ordering information and to obtain the specific Automotive Reliability reports for these models.

**NOTES**

**NOTES**

**NOTES**



# Mouser Electronics

Authorized Distributor

Click to View Pricing, Inventory, Delivery & Lifecycle Information:

## Analog Devices Inc.:

[AD8538ARZ](#) [AD8539ARZ-REEL](#) [AD8538AUJZ-REEL](#) [AD8538ARZ-REEL](#) [AD8538ARZ-REEL7](#) [AD8539ARZ](#)  
[AD8538AUJZ-REEL7](#) [AD8539ARMZ](#) [AD8538AUJZ-R2](#) [AD8539ARMZ-REEL](#) [AD8539ARZ-REEL7](#) [AD8538WAUJZ-](#)  
[R7](#)