

THIS DOCUMENT IS THE PROPERTY OF
KEYSTONE ELECTRONICS CORP. AND
SHALL NOT BE REPRODUCED, DISTRIBUTED
OR USED AS A BASIS FOR MANUFACTURE
WITHOUT PRIOR WRITTEN PERMISSION
FROM KEYSTONE ELECTRONICS CORP.

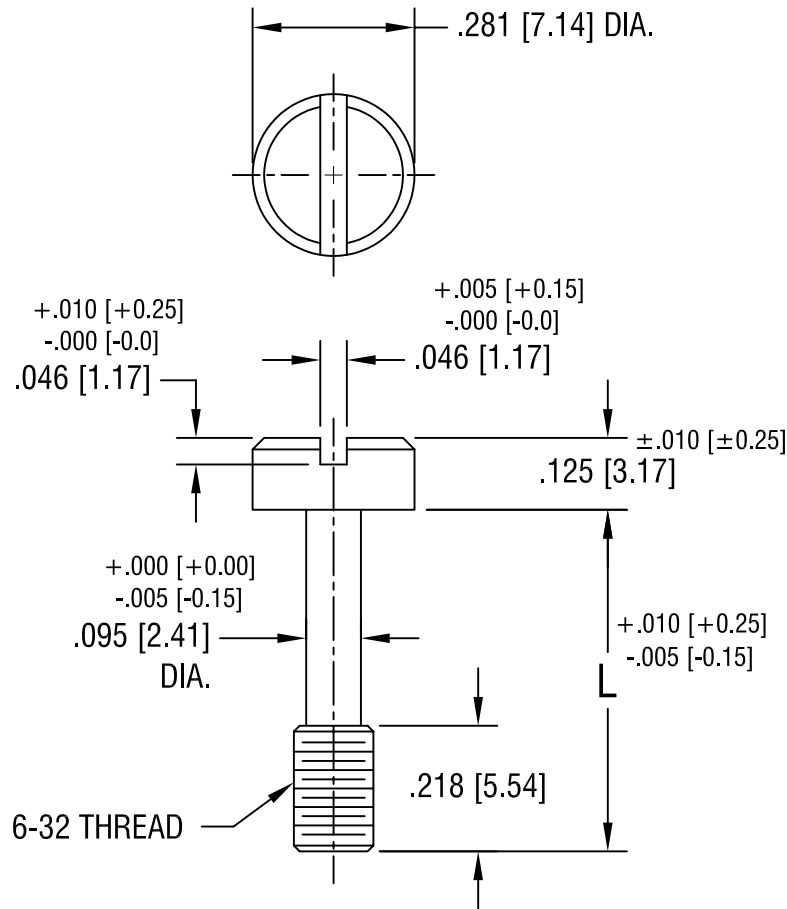

PART NO.	'L' DIM.
2415	.531 [13.49]
2416	.593 [15.06]
2417	.656 [16.66]

KEYSTONE ELECTRONICS CORP.			
ASTORIA, N.Y. 11105-2017			
PART NAME			
CAPTIVE SCREW			
MATERIAL			
STAINLESS STEEL			
FINISH		DRN BY	DATE
-		BOONE	12.5.95
		APP'D	SCALE
		LN	3X
TOLERANCES	INCH [MM]	CODE	DWG NO.
DECIMAL	$\pm .005$ [± 0.15]	C/M	2415-2417
ANGULAR	$\pm 1^\circ$		
UNLESS OTHERWISE SPECIFIED			

7.15.08	CHANGE AS PER ECN 08-124	A
DATE	DESCRIPTION	REV.

Mouser Electronics

Authorized Distributor

Click to View Pricing, Inventory, Delivery & Lifecycle Information:

[Keystone Electronics:](#)

[2416](#)