

Din rail Attachment Plate

APPLICABLE TO MODEL

Din rail width : 35mm

Plate model	FD-A	FD-B
Model	P30, P50 R50A, PAA50 RMB30A, RMC30A	P15, MMC8A R10A, R15A, R25A RMB15A, RMC15A

EXTERNAL VIEW

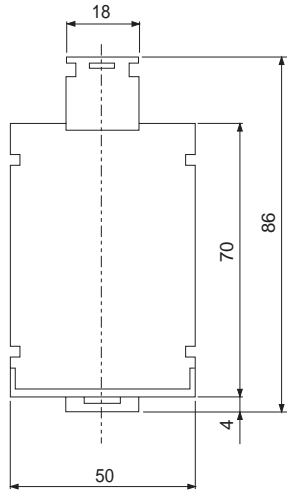
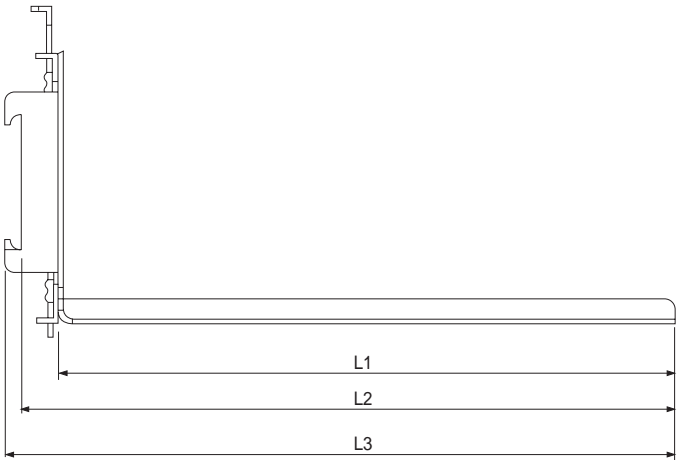

(Unit : mm)

Model	L1	L2	L3
FD-A	165	174.5	178.6
FD-B	115	124.5	128.6

★ Material : SPCC
★ Thickness : 1.6
★ Tolerance : ±1

DIN RAIL ATTACHMENT MODEL : FD-SP

MOUNTING EXAMPLE

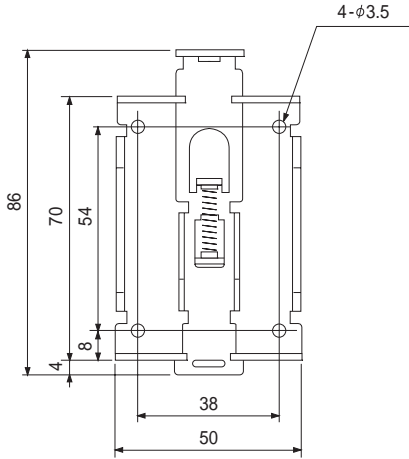
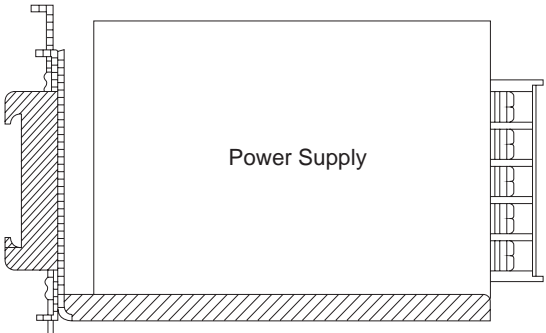

★ Material : SPCC
★ Thickness : 1.6
★ Tolerance : ±1

■ Din rail Attachment Plate(PB Series)

APPLICABLE TO MODEL

Din rail width : 35mm

Plate model	Model
FD-PBA10	PBA10F
FD-PBA15	PBA15F, PBW15F
FD-PBA30	PBA30F, PBW30F
FD-PBA50	PBA50F, PBW50F, PBA75F
FD-PBA100	PBA100F, PBA150F
FD-PBA300	PBA300F

FD-PBA10, FD-PBA15, FD-PBA30 EXTERNAL VIEW

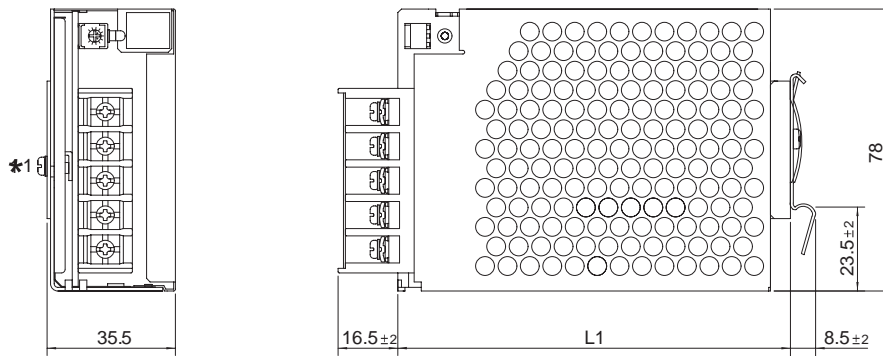

Plate model	Model	L1
FD-PBA10	PBA10F	73.5±2
FD-PBA15	PBA15F, PBW15F	90.5±2
FD-PBA30	PBA30F, PBW30F	108.5±2

- * Material : SECC
- * Thickness : 1.0
- * Tolerance : ±1
- *1 Two screws of M3 are necessary for installation

FD-PBA50, FD-PBA100
EXTERNAL VIEW

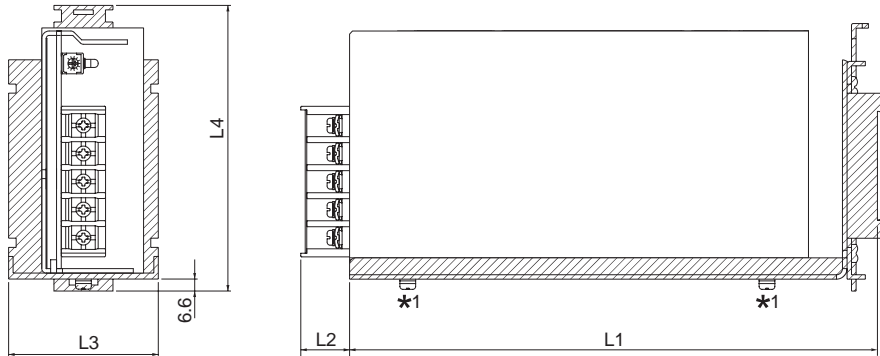

Plate model	Model	L1	L2	L3	L4
FD-PBA50	PBA50F	135	16.5±2	41	102.5
	PBA75F	150			
FD-PBA100	PBA100F	162	13.5±2	42.5	112
	PBA150F	183			

* Material : SECC
 * Thickness : 1.6
 * Tolerance : ±1
 *1 Two screws of M3 are necessary for installation

FD-PBA300
EXTERNAL VIEW

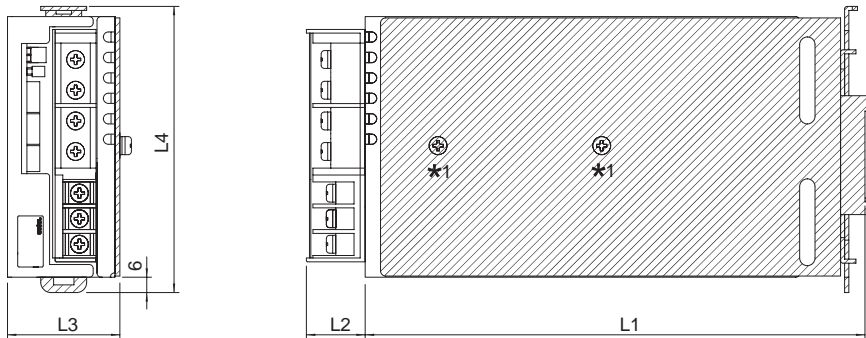

Plate model	Model	L1	L2	L3	L4
FD-PBA300	PBA300F	195.5	25max	44	112

* Material : SPHC
 * Thickness : 2.0
 * Tolerance : ±1
 *1 Two screws of M4 are necessary for installation

Mouser Electronics

Authorized Distributor

Click to View Pricing, Inventory, Delivery & Lifecycle Information:

Cosel:

[FD-PBA15](#) [FD-PBA30](#) [FD-PBA10](#) [FD-B](#) [FD-PBA50](#) [FD-A](#) [FD-PBA100](#) [FD-SP](#)