

PRODUCT NUMBER  
XXXXX-YYYHTLF

- LEAD FREE OPTION  
SEE NOTE 1,10
- TUBE PACKAGING OPTION  
SEE NOTE 1
- HIGH TEMPERATURE PLASTIC  
SEE NOTE 1
- NO OF POSITIONS  
SEE NOTE 1
- PIN PLATING  
SEE SHEET 2
- BASE PART NO.

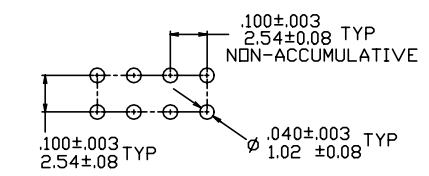
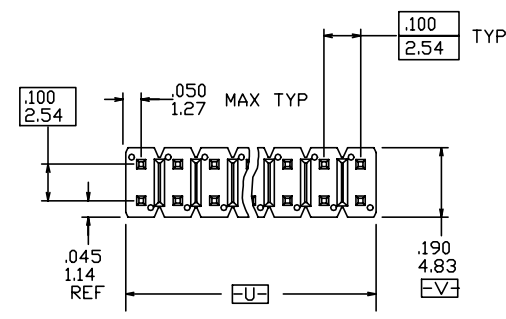

TOP VIEW

RECOMMENDED HOLE PATTERN

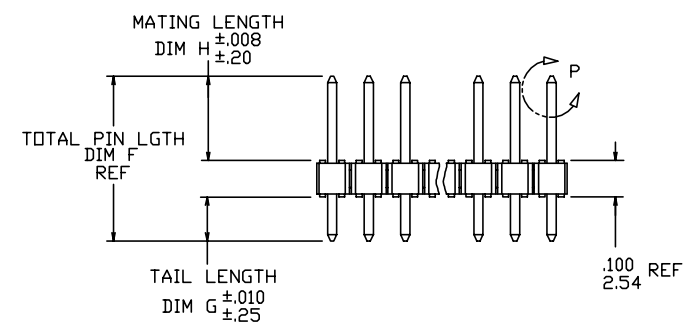

SIDE VIEW

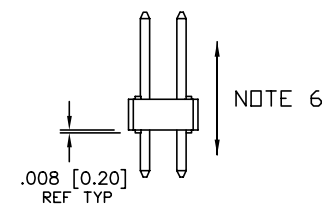

END VIEW

⊕ ∅ .020/.51 (M) U (M) V (S)

NOTE 4

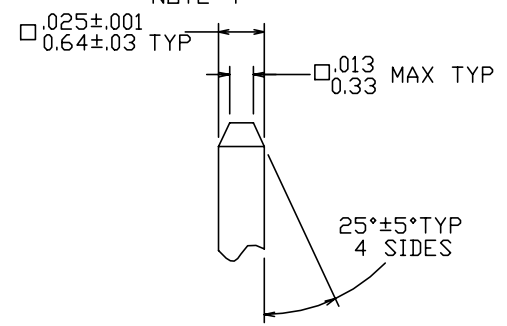

DETAIL P  
TYP BOTH ENDS

ELX-N-16105

rev	ecn no	dr	date
AP	ELX-N-16105	ZK	2013-10-22
AJ	M05-0072	MHT	5/03/05
AK	M06-0269	MHT	7/17/06
AL	M06-0346	MHT	9/04/06
AM	M08-0291	MHT	10/06/08
AN	N11-0118	J.Z	2011-04-12

www.fciconnect.com		surface 6.4 ISO 1302	tolerance std ISO 406 ISO 1101	projection size A4	INCH/MM Scale 1.000
Dr	T. BREWBAKER	7/29/94	ANGULAR	0.X ±.3	ECN
Eng	T.HANNA	7/29/94	LINEAR	0.XX ±.15	
Chr	J. MURPHY	7/29/94	0° ±2°	0.XXX ±.05	
Appr	T.HANNA	7/29/94	Product family BERGSTIK		Spec ref
FCI			title BERGSTIK® II HEADER .100/2.54 DR SELF-RET		Rev. AP
catalog no			CUSTOMER		sheet 1 of 4



Copyright FCI.

PIN PLATING CODES:

XXXX-1YY	30u"/0.76u MIN (SEE NOTE 11) OVER 50u"/1.27u MIN Ni
XXXX-2YY	15u"/0.38u MIN (SEE NOTE 11) OVER 50u"/1.27u MIN Ni
XXXX-3YY	50u"/1.27u MIN (SEE NOTE 11) OVER 50u"/1.27u MIN Ni
XXXX-4YY	100u"/2.54u MIN Sn OVER 50u"/1.27u MIN Ni (SEE NOTE 12)
XXXX-4YHLF	
XXXX-5YY	15u"/0.38u MIN (SEE NOTE 11) OVER 50u"/1.27u MIN Ni
XXXX-6YY	30u"/0.76u MIN (SEE NOTE 11) OVER 50u"/1.27u MIN Ni
XXXX-7YY	30u"/0.76u MIN (SEE NOTE 11) OVER 50u"/1.27u MIN Ni
XXXX-8YY	15u"/0.38u MIN (SEE NOTE 11) OVER 50u"/1.27u MIN Ni
XXXX-9YY	15u"/0.38u MIN (SEE NOTE 11) OVER 50u"/1.27u MIN Ni
XXXX-0YY	30u"/0.76u MIN (SEE NOTE 11) OVER 50u"/1.27u MIN Ni

NOTES

① PART NUMBER OPTIONS:

PIN PLATING CODES (SEE ABOVE)

HIGH TEMP. MATERIAL:

FOR HIGH-TEMPERATURE APPLICATIONS, SPECIFY AN "H" AT THE END OF THE PART NUMBER, AND PCT WILL BE SUPPLIED.

NUMBER OF POSITION:

ANY NUMBER OF POSITIONS FROM 2 (2X1) THRU 72 (2X36).

PACKAGING:

PACKAGED IN POLY BAGS.

EIGHT DIGIT PART NUMBERS FOLLOWED BY A "T" ARE PACKAGED IN TUBES. SEE SPECIFIC PART NUMBERS FOR AVAILABILITY.

LEAD FREE:

ADD "HLF" SUFFIX AT THE END OF PART NUMBER FOR LEAD FREE OPTION, NOT AVAILABLE FOR -5YY,-5YYH,-6YY & -6YYH.

② BODY MATERIAL:

MANUFACTURER'S OPTION OF NYLON OR PCT, GLASS FIBER REINFORCED, FLAME RETARDENT PER UL-94V-0.

COLOR: BLACK. OR

MINERAL FILLED LCP, COLOR BLACK

FLAME RETARDENT PER UL-94V-0

PART NUMBERS WITH "H" SUFFIX WILL WITHSTAND EXPOSURE TO 260°C PEAK TEMPERATURE FOR 20 SECONDS IN WAVE SOLDER, INFRA-RED OR VAPOR PHASE SOLDER PROCESS.

PART NUMBERS WITHOUT "H" SUFFIX WILL WITHSTAND EXPOSURE TO 260°C PEAK TEMPERATURE FOR WAVE SOLDER PROCESS.

- ③. PIN MATERIAL: PHOS-BRONZE.
- ④. MEASURED WITH PART IN RESTRAINED CONDITION.
- 5. TWO SIDES OF PIN TIPS NOT PLATED. TYPICAL BOTH ENDS.
- ⑥. 2LBS/0.9KG MIN PIN RETENTION IN EITHER DIRECTION.
- ⑦. ±.010/0.25 TOL. APPLIES TO ALL "G" TAILS EXCEPT INDICATED PARTS ON TABLE WHERE +.010/0.25,-.000/0.00 APPLIES.
- ⑧. SECTION R-R DIMENSIONS APPLY TO RETENTION PIN POSITIONS ONLY LOCATED AT MANUFACTURES OPTION.
- 9. 5LB/2.3KG MAX INSERTION FORCE AND .25LB/.1KG MIN RETENTION FORCE PER RETENTIVE PIN USING .062/1.57 THICK CIRCUIT BOARDS AND RECOMMENDED HOLE PATTERN.
- ⑩. THESE PRODUCTS MEETS EUROPEAN UNION DIRECTIVES AND OTHER COUNTRY REGULATION AS DESCRIBED IN GS-22-008.
- ⑪. PLATING OPTIONS:  
PERFORMANCE PLATING WILL BE EITHER GOLD OR GXT ON POST OR TAIL, OPTIONALLY (78~295u"/2~7.5u) TIN ON TAIL.
- ⑫. THIS PRODUCT HAS 100% TIN PLATING IN THE INTERFACE AND HAS NOT BEEN TESTED FOR WHISKER GROWTH IN ALL INTERCONNECT ENVIRONMENTS."



Copyright FCI.

www.fciconnect.com			surface ISO 1302 ✓	tolerance std ISO 406 ISO 1101	projection	INCH/MM
			TOLERANCES UNLESS OTHERWISE SPECIFIED			
Dr	T. BREWBAKER	7/29/94	ANGULAR	LINEAR	0.X	±0.3
Eng	T.HANNA	7/29/94			0.XX	±0.15
Chr	J. MURPHY	7/29/94	0°	±2°	0.XXX	±0.05
Appr	T.HANNA	7/29/94	Product family		BERGSTIK	Spec ref
			title		BERGSTIK® II HEADER	dwg no
					.100/2.54 DR SELF-RET	
			catalog no		CUSTOMER	sheet 2 of 4
					69192	Rev. AP

1

2

3

4

A

B

C

D

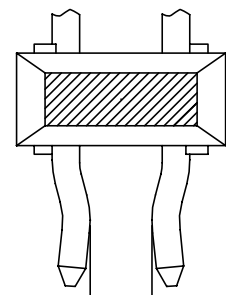
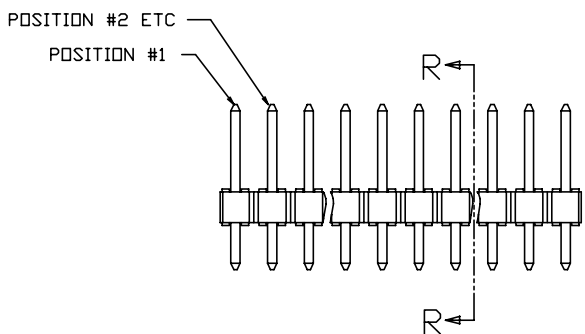

.056 ±.003  
1.42 ±.07

SECTION R-R  
NOTE 8

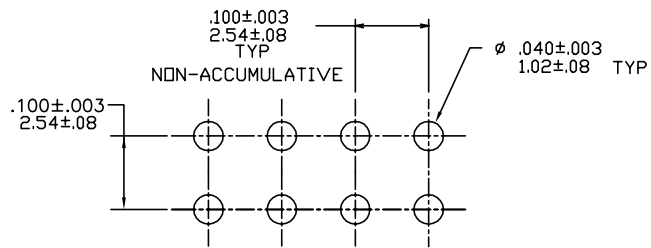

RECOMMENDED HOLE PATTERN



Copyright FCI.

www.fciconnect.com			surface ISO 1302 ✓	tolerance std ISO 406 ISO 1101	projection A4	INCH/MM
			TOLERANCES UNLESS OTHERWISE SPECIFIED		←→	
Dr	T. BREWBAKER	7/29/94	ANGULAR	LINEAR	0.X	±0.3
Eng	T.HANNA	7/29/94			0.XX	±0.15
Chr	J. MURPHY	7/29/94	0°	±2°	0.XXX	±0.05
Appr	T.HANNA	7/29/94	Product family		BERGSTIK	Spec ref
			title		Rev.	
			BERGSTIK® II HEADER		AP	
			.100/2.54 DR SELF-RET		69192	
			catalog no		CUSTOMER	
					sheet 3 of 4	

REV F - 2006-04-17

1

2

3

4

PDS: Rev :AP

STATUS:Released

Printed: Oct 29, 2013

PRODUCT NUMBER	TOTAL PIN LENGTH		TAIL LENGTH		MATING LENGTH		PACKAGING	NOTES	LF OPTION
	DIM F	DIM F	DIM G	DIM G	DIM H	DIM H			
	ENGLISH	METRIC	ENGLISH	METRIC	ENGLISH	METRIC			
69192-XY	0.450	11.43	0.120	3.05	0.230	5.84	POLY BAGS/TUBES		NOTE 1,10
78252-XY	U N A V A I L A B L E								
78548-XY	0.538	13.67	0.120	3.05	0.318	8.08	POLY BAGS		
<del>78577-XY</del>	<del>0.650</del>	<del>16.51</del>	<del>0.120</del>	<del>3.05</del>	<del>0.430</del>	<del>10.92</del>	<del>POLY BAGS</del>		OB
<del>79214-XY</del>	<del>0.620</del>	<del>15.75</del>	<del>0.120</del>	<del>3.05</del>	<del>0.400</del>	<del>10.16</del>	<del>POLY BAGS</del>		OB
<del>79979-XY</del>	<del>0.450</del>	<del>11.43</del>	<del>0.120</del>	<del>3.05</del>	<del>0.230</del>	<del>5.84</del>	<del>POLY BAGS/TUBES</del>	<del>7</del>	OB
86380-XY	0.470	11.94	0.120	3.05	0.250	6.35	POLY BAGS		
<del>86584-XY</del>	<del>0.760</del>	<del>19.30</del>	<del>0.120</del>	<del>3.05</del>	<del>0.540</del>	<del>13.72</del>	<del>POLY BAGS</del>		OB
<del>87444-XY</del>	<del>1.090</del>	<del>27.69</del>	<del>0.125</del>	<del>3.18</del>	<del>0.865</del>	<del>21.97</del>	<del>POLY BAGS</del>		OB
<del>87456-XY</del>	<del>0.840</del>	<del>21.34</del>	<del>0.120</del>	<del>3.05</del>	<del>0.620</del>	<del>15.75</del>	<del>POLY BAGS</del>		OB
<del>87457-XY</del>	<del>0.990</del>	<del>25.15</del>	<del>0.120</del>	<del>3.05</del>	<del>0.770</del>	<del>19.56</del>	<del>POLY BAGS</del>		OB
<del>87837-XY</del>	<del>0.585</del>	<del>14.86</del>	<del>0.120</del>	<del>3.05</del>	<del>0.365</del>	<del>9.27</del>	<del>POLY BAGS</del>		OB
<del>87920-XY</del>	<del>0.830</del>	<del>21.08</del>	<del>0.120</del>	<del>3.05</del>	<del>0.610</del>	<del>15.49</del>	<del>POLY BAGS</del>		OB
<del>88526-XY</del>	<del>1.340</del>	<del>34.04</del>	<del>0.120</del>	<del>3.05</del>	<del>1.120</del>	<del>28.45</del>	<del>POLY BAGS</del>		OB
<del>88714-XY</del>	<del>0.640</del>	<del>16.26</del>	<del>0.120</del>	<del>3.05</del>	<del>0.420</del>	<del>10.67</del>	<del>POLY BAGS</del>		OB
<del>89580-XY</del>	<del>0.930</del>	<del>23.62</del>	<del>0.120</del>	<del>3.05</del>	<del>0.710</del>	<del>18.03</del>	<del>POLY BAGS</del>		OB
90824-XY	0.420	10.67	0.120	3.05	0.200	5.08	POLY BAGS		
94654-XYH	0.415	10.54	0.085	2.16	0.230	5.84	POLY BAGS		
95066-XYH	1.240	31.50	0.120	3.05	1.020	25.91	POLY BAGS		NOTE 1,10
<del>95654-XYH</del>	<del>0.880</del>	<del>22.35</del>	<del>0.120</del>	<del>3.05</del>	<del>0.660</del>	<del>16.76</del>	<del>POLY BAGS</del>		OB
<del>98845-XYH</del>	<del>0.572</del>	<del>14.54</del>	<del>0.120</del>	<del>3.00</del>	<del>0.354</del>	<del>9.00</del>	<del>POLY BAGS/TUBES</del>		OB
<del>10002463-XYH</del>	<del>0.503</del>	<del>12.78</del>	<del>0.085</del>	<del>2.16</del>	<del>0.318</del>	<del>8.08</del>	<del>POLY BAGS</del>		OB

A

B

C

A

B

C



Copyright FCI.

D

D

www.fciconnect.com			surface ISO 1302 <input checked="" type="checkbox"/>	tolerance std ISO 406 ISO 1101	projection 	INCH/MM	
			TOLERANCES UNLESS OTHERWISE SPECIFIED			← INCH/MM →	
Dr	T. BREWBAKER	7/29/94	ANGULAR	LINEAR	0.X	±0.3	size A4
Eng	T.HANNA	7/29/94			0.XX	±0.15	Scale 1.000
Chr	J. MURPHY	7/29/94	0°	±2°	0.XXX	±0.05	ECN
Appr	T.HANNA	7/29/94	Product family		BERGSTIK		Spec ref
			title		BERGSTIK® II HEADER .100/2.54 DR SELF-RET		Rev. AP
			catalog no		CUSTOMER		sheet 4 of 4

# Mouser Electronics

Authorized Distributor

Click to View Pricing, Inventory, Delivery & Lifecycle Information:

## [FCI / Amphenol:](#)

[69192-110](#) [69192-128](#) [69192-404H](#) [78548-210H](#) [86380-410](#) [69192-102](#) [69192-104](#) [69192-106](#) [69192-112](#)  
[69192-114](#) [69192-118](#) [69192-120](#) [69192-122H](#) [69192-124](#) [69192-126](#) [69192-130](#) [69192-136](#) [69192-150](#) [69192-160](#) [69192-164](#) [69192-172](#) [69192-202](#) [69192-210](#) [69192-214](#) [69192-216](#) [69192-226](#) [69192-234](#) [69192-236](#)  
[69192-240](#) [69192-242](#) [69192-250](#) [69192-260](#) [69192-264](#) [69192-272](#) [69192-350H](#) [69192-402H](#) [69192-410](#) [69192-412](#) [69192-424](#) [69192-430](#) [69192-432](#) [69192-436](#) [69192-440](#) [69192-450](#) [69192-460](#) [69192-472](#) [69192-502](#)  
[69192-504](#) [69192-506](#) [69192-510](#) [69192-514](#) [69192-516](#) [69192-518](#) [69192-520](#) [69192-526](#) [69192-528](#) [69192-530](#)  
[69192-534](#) [69192-536H](#) [69192-540](#) [69192-550H](#) [69192-560H](#) [69192-572](#) [69192-604](#) [69192-606](#) [69192-610](#)  
[69192-612H](#) [69192-614](#) [69192-616](#) [69192-616H](#) [69192-618](#) [69192-620](#) [69192-624H](#) [69192-626](#) [69192-628](#)  
[69192-630](#) [69192-634](#) [69192-650](#) [69192-660](#) [69192-672](#) [78548-102](#) [78548-104](#) [78548-106](#) [78548-108](#) [78548-112](#)  
[78548-114](#) [78548-116](#) [78548-118](#) [78548-120](#) [78548-124](#) [78548-126](#) [78548-128](#) [69192-208](#) [69192-220](#) [69192-206](#) [69192-406](#) [69192-420](#) [69192-206HLF](#) [78548-130](#) [78548-132](#)