

FEATURES

14-bit, 40 MSPS/65 MSPS ADC

Low power

550 mW at 65 MSPS

300 mW at 40 MSPS

On-chip reference and sample-and-hold

750 MHz analog input bandwidth

SNR > 73 dBc to Nyquist @ 65 MSPS

SFDR > 86 dBc to Nyquist @ 65 MSPS

Differential nonlinearity error = ± 0.7 LSB

Guaranteed no missing codes over full temperature range

1 V to 2 V p-p differential full-scale analog input range

Single 5 V analog supply, 3.3 V/5 V driver supply

Out-of-range indicator

Straight binary or twos complement output data

Clock duty cycle stabilizer

Output-enable function

48-lead LQFP package

APPLICATIONS

Communication subsystems (microcell, picocell)

Medical and high-end imaging equipment

Test and measurement equipment

GENERAL DESCRIPTION

The AD9244 is a monolithic, single 5 V supply, 14-bit, 40 MSPS/65 MSPS ADC with an on-chip, high performance sample-and-hold amplifier (SHA) and voltage reference.

The AD9244 uses a multistage differential pipelined architecture with output error correction logic to provide 14-bit accuracy at 40 MSPS/65 MSPS data rates, and guarantees no missing codes over the full operating temperature range.

The AD9244 has an on-board, programmable voltage reference. An external reference can also be used to suit the dc accuracy and temperature drift requirements of the application.

A differential or single-ended clock input controls all internal conversion cycles. The digital output data can be presented in straight binary or in twos complement format. An out-of-range (OTR) signal indicates an overflow condition that can be used with the most significant bit to determine low or high overflow.

FUNCTIONAL BLOCK DIAGRAM

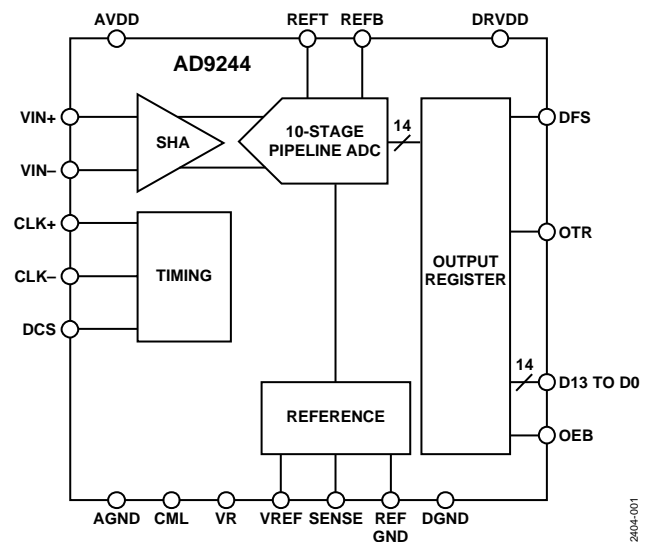

Figure 1.

Fabricated on an advanced CMOS process, the AD9244 is available in a 48-lead LQFP and is specified for operation over the industrial temperature range (-40°C to $+85^{\circ}\text{C}$).

PRODUCT HIGHLIGHTS

- Low Power**—The AD9244, at 550 mW, consumes a fraction of the power of currently available ADCs in existing high speed solutions.
- IF Sampling**—The AD9244 delivers outstanding performance at input frequencies beyond the first Nyquist zone. Sampling at 65 MSPS with an input frequency of 100 MHz, the AD9244 delivers 71 dB SNR and 86 dB SFDR.
- Pin Compatibility**—The AD9244 offers a seamless migration from the 12-bit, 65 MSPS AD9226.
- On-Board Sample-and-Hold (SHA)**—The versatile SHA input can be configured for either single-ended or differential inputs.
- Out-of-Range (OTR) Indicator**—The OTR output bit indicates when the input signal is beyond the AD9244's input range.
- Single Supply**—The AD9244 uses a single 5 V power supply, simplifying system power supply design. It also features a separate digital output driver supply to accommodate 3.3 V and 5 V logic families.

Rev. C

Information furnished by Analog Devices is believed to be accurate and reliable. However, no responsibility is assumed by Analog Devices for its use, nor for any infringements of patents or other rights of third parties that may result from its use. Specifications subject to change without notice. No license is granted by implication or otherwise under any patent or patent rights of Analog Devices. Trademarks and registered trademarks are the property of their respective owners.

TABLE OF CONTENTS

Features	1	Terminology	9
Functional Block Diagram	1	Typical Application Circuits	11
Applications	1	Typical Performance Characteristics	12
General Description	1	Theory of Operation	17
Product Highlights	1	Analog Input and Reference Overview	17
Revision History	2	Analog Input Operation	18
Specifications.....	3	Reference Operation	20
DC Specifications	3	Digital Inputs and Outputs	21
AC Specifications.....	4	Evaluation Board	26
Digital Specifications	5	Analog Input Configuration	26
Switching Specifications	6	Reference Configuration	26
Absolute Maximum Ratings.....	7	Clock Configuration	26
Explanation of Test Levels.....	7	Outline Dimensions	36
ESD Caution.....	7	Ordering Guide	36
Pin Configuration and Function Descriptions.....	8		

REVISION HISTORY

12/05—Rev. B to Rev. C

Updated Format.....	Universal
Changes to Figure 45.....	19
Added Single-Ended Input Configuration Section.....	19
Added Reference Decoupling Section	25
Changes to Figure 65.....	28
Changes to Figure 66.....	29
Changes to Figure 67.....	30
Added Table 15	34

2/05—Rev. A to Rev. B

Updated Format.....	Universal
Changes to Table 1.....	3
Changes to Table 2.....	4
Reformatted Table 5	7
Changes to Table 6.....	8
Changes to Figure 12.....	12
Changed Captions on Figure 18 and Figure 21	13
Changes to Figure 35, Figure 38, Figure 39.....	16
Changes to Table 9.....	18
Changes to Table 13	26
Changes to Ordering Guide	36

6/03—Rev. 0 to Rev. A

Changes to AC Specifications	3
Updated Ordering Guide	6
Updated Outline Dimensions.....	33

6/02—Revision 0: Initial Version

SPECIFICATIONS

DC SPECIFICATIONS

AVDD = 5 V, DRVDD = 3 V, $f_{\text{SAMPLE}} = 65 \text{ MSPS} (-65)$ or $40 \text{ MSPS} (-40)$, differential clock inputs, VREF = 2 V, external reference, differential analog inputs, unless otherwise noted.

Table 1.

Parameter	Temp	Test Level	AD9244BST-65			AD9244BST-40			Unit
			Min	Typ	Max	Min	Typ	Max	
RESOLUTION	Full	VI	14			14			Bits
DC ACCURACY									
No Missing Codes	Full	VI		Guaranteed			Guaranteed		Bits
Offset Error	Full	VI		±0.3	±1.4		±0.3	±1.4	% FSR
Gain Error ¹	Full	VI		±0.6	±2.0		±0.6	±2.0	% FSR
Differential Nonlinearity (DNL) ²	Full	VI			±1.0			±1.0	LSB
	25°C	V		±0.7			±0.6		LSB
Integral Nonlinearity (INL) ²	Full	V		±1.4			±1.3		LSB
	Full	VI	-4		+4	-4		+4	LSB
TEMPERATURE DRIFT									
Offset Error	Full	V		±2.0			±2.0		ppm/°C
Gain Error (EXT VREF) ¹	Full	V		±2.3			±2.3		ppm/°C
Gain Error (INT VREF) ³	Full	V		±25			±25		ppm/°C
INTERNAL VOLTAGE REFERENCE									
Output Voltage Error (2 VREF)	Full	VI			±29			±29	mV
Load Regulation @ 1 mA	Full	V		0.5			0.5		mV
Output Voltage Error (1 VREF)	Full	IV			±15			±15	mV
Load Regulation @ 0.5 mA	Full	V		0.25			0.25		mV
Input Resistance	Full	V		5			5		kΩ
INPUT REFERRED NOISE									
VREF = 2 V	25°C	V		0.8			0.8		LSB rms
VREF = 1 V	25°C	V		1.5			1.5		LSB rms
ANALOG INPUT									
Input Voltage Range (Differential)									
VREF = 2 V	Full	V		2			2		V p-p
VREF = 1 V	Full	V		1			1		V p-p
Common-Mode Voltage	Full	V	0.5		4	0.5		4	V
Input Capacitance ⁴	25°C	V		10			10		pF
Input Bias Current ⁵	25°C	V		500			500		μA
Analog Bandwidth (Full Power)	25°C	V		750			750		MHz
POWER SUPPLIES									
Supply Voltages									
AVDD	Full	IV	4.75	5	5.25	4.75	5	5.25	V
DRVDD	Full	IV	2.7		5.25	2.7		5.25	V
Supply Current									
IAVDD	Full	V		109			64		mA
IDRVDD	Full	V		12			8		mA
PSRR	Full	V		±0.05			±0.05		% FSR
POWER CONSUMPTION									
DC Input ⁶	Full	V		550			300		mW
Sine Wave Input	Full	VI		590	640		345	370	mW

¹ Gain error is based on the ADC only (with a fixed 2.0 V external reference).

² Measured at maximum clock rate, $f_{\text{IN}} = 2.4 \text{ MHz}$, full-scale sine wave, with approximately 5 pF loading on each output bit.

³ Includes internal voltage reference error.

⁴ Input capacitance refers to the effective capacitance between one differential input pin and AGND. Refer to Figure 7 for the equivalent analog input structure.

⁵ Input bias current is due to the input looking like a resistor that is dependent on the clock rate.

⁶ Measured with dc input at maximum clock rate.

AD9244

AC SPECIFICATIONS

AVDD = 5 V, DRVDD = 3 V, $f_{\text{SAMPLE}} = 65 \text{ MSPS} (-65)$ or $40 \text{ MSPS} (-40)$, differential clock inputs, VREF = 2 V, external reference, $A_{\text{IN}} = -0.5 \text{ dBFS}$, differential analog inputs, unless otherwise noted.

Table 2.

Parameter	Temp	Test Level	AD9244BST-65			AD9244BST-40			Unit
			Min	Typ	Max	Min	Typ	Max	
SNR¹									
$f_{\text{IN}} = 2.4 \text{ MHz}$	Full 25°C	VI I	72.4	74.8		73.4	75.3		dBc dBc
$f_{\text{IN}} = 15.5 \text{ MHz} (-1 \text{ dBFS})$	Full 25°C	IV V	72.0	73.7					dBc dBc
$f_{\text{IN}} = 20 \text{ MHz}$	Full 25°C	VI I				72.1	74.7		dBc dBc
$f_{\text{IN}} = 32.5 \text{ MHz}$	Full 25°C	IV I	70.8	73.0					dBc dBc
$f_{\text{IN}} = 70 \text{ MHz}$	Full 25°C	IV V	69.9	72.2					dBc dBc
$f_{\text{IN}} = 100 \text{ MHz}$	25°C	V		71.2			72.8		dBc
$f_{\text{IN}} = 200 \text{ MHz}$	25°C	V		67.2			68.3		dBc
SINAD¹									
$f_{\text{IN}} = 2.4 \text{ MHz}$	Full 25°C	VI I	72.2	74.7		73.2	75.1		dBc dBc
$f_{\text{IN}} = 20 \text{ MHz}$	Full 25°C	VI I				72	74.4		dBc dBc
$f_{\text{IN}} = 32.5 \text{ MHz}$	Full 25°C	IV I	70.6	72.6					dBc dBc
$f_{\text{IN}} = 70 \text{ MHz}$	Full 25°C	IV V	69.7	71.9					dBc dBc
$f_{\text{IN}} = 100 \text{ MHz}$	25°C	V		71			72.4		dBc
$f_{\text{IN}} = 200 \text{ MHz}$	25°C	V		59.8			56.3		dBc
ENOB									
$f_{\text{IN}} = 2.4 \text{ MHz}$	Full 25°C	VI I	11.7	12.1		11.9	12.2		Bits Bits
$f_{\text{IN}} = 20 \text{ MHz}$	Full 25°C	VI I				11.7	12.1		Bits Bits
$f_{\text{IN}} = 32.5 \text{ MHz}$	Full 25°C	IV I	11.4	11.8					Bits Bits
$f_{\text{IN}} = 70 \text{ MHz}$	Full 25°C	IV V	11.3	11.7					Bits Bits
$f_{\text{IN}} = 100 \text{ MHz}$	25°C	V		11.5			11.7		Bits
$f_{\text{IN}} = 200 \text{ MHz}$	25°C	V		9.6			9.1		Bits
THD¹									
$f_{\text{IN}} = 2.4 \text{ MHz}$	Full 25°C	VI I			-78.4			-80.7	dBc dBc
$f_{\text{IN}} = 20 \text{ MHz}$	Full 25°C	VI I		-90.0			-89.7	-80.4	dBc dBc
$f_{\text{IN}} = 32.5 \text{ MHz}$	Full 25°C	IV I			-79.2		-89.4		dBc dBc
$f_{\text{IN}} = 70 \text{ MHz}$	Full 25°C	IV V		-84.6	-78.7				dBc dBc
$f_{\text{IN}} = 100 \text{ MHz}$	25°C	V		-84.1					dBc
$f_{\text{IN}} = 200 \text{ MHz}$	25°C	V		-83.0			-83.2		dBc
	25°C	V		-60.7			-56.6		dBc

Parameter	Temp	Test Level	AD9244BST-65			AD9244BST-40			Unit
			Min	Typ	Max	Min	Typ	Max	
WORST HARMONIC (SECOND or THIRD) ¹									
$f_{IN} = 2.4$ MHz	25°C	V		-94.5		-93.7			dBc
$f_{IN} = 20$ MHz	25°C	V				-92.8			dBc
$f_{IN} = 32.5$ MHz	25°C	V		-86.5					dBc
$f_{IN} = 70$ MHz	25°C	V		-86.1					dBc
$f_{IN} = 100$ MHz	25°C	V		-86.2		-84.5			dBc
$f_{IN} = 200$ MHz	25°C	V		-60.7		-56.6			dBc
SFDR ¹									
$f_{IN} = 2.4$ MHz	Full	VI	78.6			82.5			dBc
	25°C	I		94.5			93.7		dBc
$f_{IN} = 15.5$ MHz (-1 dBFS)	Full	IV	83						dBc
	25°C	V		90					dBc
$f_{IN} = 20$ MHz	Full	IV				81.4			dBc
	25°C	I					91.8		dBc
$f_{IN} = 32.5$ MHz	Full	IV	80.0						dBc
	25°C	I		86.4					dBc
$f_{IN} = 70$ MHz	Full	IV	79.5						dBc
	25°C	V		86.1					dBc
$f_{IN} = 100$ MHz	25°C	V		86.2			84.5		dBc
$f_{IN} = 200$ MHz	25°C	V		60.7			56.6		dBc

¹ AC specifications can be reported in dBc (degrades as signal levels are lowered) or in dBFS (always related back to converter full scale).

DIGITAL SPECIFICATIONS

AVDD = 5 V, DRVDD = 3 V, VREF = 2 V, external reference, unless otherwise noted.

Table 3.

Parameter	Temp	Test Level	AD9244BST-65			AD9244BST-40			Unit
			Min	Typ	Max	Min	Typ	Max	
DIGITAL INPUTS									
Logic 1 Voltage (OEB, DRVDD = 3 V)	Full	IV	2			2			V
Logic 1 Voltage (OEB, DRVDD = 5 V)	Full	IV	3.5			3.5			V
Logic 0 Voltage (OEB)	Full	IV			0.8			0.8	V
Logic 1 Voltage (DFS, DCS)	Full	IV	3.5			3.5			V
Logic 0 Voltage (DFS, DCS)	Full	IV			0.8			0.8	V
Input Current	Full	IV			10			10	μA
Input Capacitance	Full	V		5			5		pF
CLOCK INPUT PARAMETERS									
Differential Input Voltage	Full	IV	0.4			0.4			V p-p
CLK- Voltage ¹	Full	IV	0.25			0.25			V
Internal Clock Common-Mode	Full	V		1.6			1.6		V
Single-Ended Input Voltage									
Logic 1 Voltage	Full	IV	2			2			V
Logic 0 Voltage	Full	IV			0.8			0.8	V
Input Capacitance	Full	V		5			5		pF
Input Resistance	Full	V		100			100		kΩ
DIGITAL OUTPUTS (DRVDD = 5 V)									
Logic 1 Voltage ($I_{OH} = 50$ μA)	Full	IV	4.5			4.5			V
Logic 0 Voltage ($I_{OL} = 50$ μA)	Full	IV			0.1			0.1	V
Logic 1 Voltage ($I_{OH} = 0.5$ mA)	Full	IV	2.4			2.4			V
Logic 0 Voltage ($I_{OL} = 1.6$ mA)	Full	IV			0.4			0.4	V

AD9244

Parameter	Temp	Test Level	AD9244BST-65			AD9244BST-40			Unit
			Min	Typ	Max	Min	Typ	Max	
DIGITAL OUTPUTS (DRVDD = 3 V) ²									
Logic 1 Voltage (I _{OH} = 50 μA)	Full	IV	2.95			2.95			V
Logic 0 Voltage (I _{OL} = 50 μA)	Full	IV			0.05		0.05		V
Logic 1 Voltage (I _{OH} = 0.5 mA)	Full	IV	2.8			2.8			V
Logic 0 Voltage (I _{OL} = 1.6 mA)	Full	IV			0.4		0.4		V

¹ See the Clock Overview section for more details.

² Output voltage levels measured with 5 pF load on each output.

SWITCHING SPECIFICATIONS

AVDD = 5 V, DRVDD = 3 V, unless otherwise noted.

Table 4.

Parameter	Temp	Test Level	AD9244BST-65			AD9244BST-40			Unit
			Min	Typ	Max	Min	Typ	Max	
CLOCK INPUT PARAMETERS									
Maximum Conversion Rate	Full	VI	65			40			MHz
Minimum Conversion Rate	Full	V			500		500		kHz
Clock Period ¹	Full	V	15.4			25			ns
Clock Pulse Width High ²	Full	V	4			4			ns
Clock Pulse Width Low ²	Full	V	4			4			ns
Clock Pulse Width High ³	Full	V	6.9			11.3			ns
Clock Pulse Width Low ³	Full	V	6.9			11.3			ns
DATA OUTPUT PARAMETERS									
Output Delay (t _{PD}) ⁴	Full	V	3.5		7	3.5		7	ns
Pipeline Delay (Latency)	Full	V		8			8		Clock cycles
Aperture Delay (t _A)	Full	V		1.5			1.5		ns
Aperture Uncertainty (Jitter)	Full	V		0.3			0.3		ps rms
Output Enable Delay	Full	V		15			15		ns
OUT-OF-RANGE RECOVERY TIME	Full	V		2			1		Clock cycles

¹ The clock period can be extended to 2 μs with no degradation in specified performance at 25°C.

² With duty cycle stabilizer enabled.

³ With duty cycle stabilizer disabled.

⁴ Measured from clock 50% transition to data 50% transition with 5 pF load on each output.

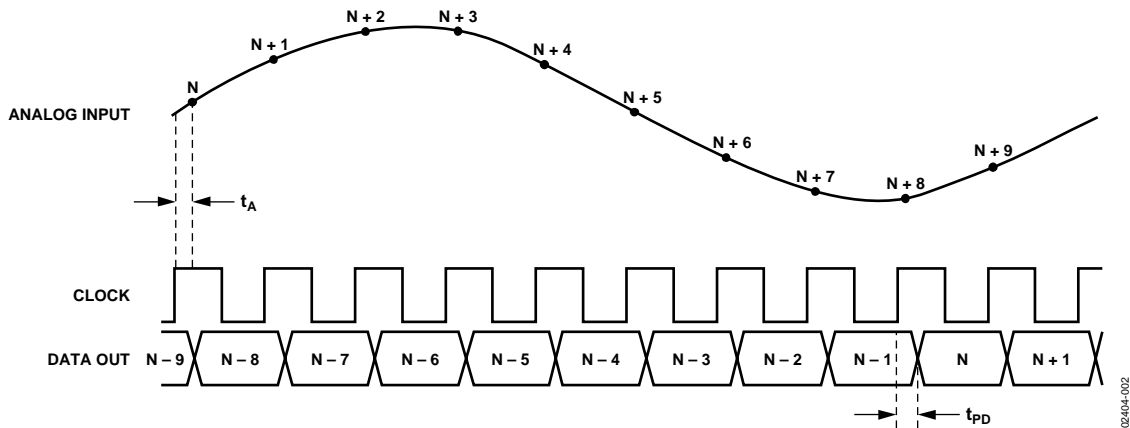

Figure 2. Input Timing

ABSOLUTE MAXIMUM RATINGS

Table 5.

Parameter	With Respect to	Rating
ELECTRICAL		
AVDD	AGND	-0.3 V to +6.5 V
DRVDD	DGND	-0.3 V to +6.5 V
AGND	DGND	-0.3 V to +0.3 V
AVDD	DRVDD	-6.5 V to +6.5 V
REFGND	AGND	-0.3 V to +0.3 V
CLK+, CLK-, DCS	AGND	-0.3 V to AVDD + 0.3 V
DFS	AGND	-0.3 V to AVDD + 0.3 V
VIN+, VIN-	AGND	-0.3 V to AVDD + 0.3 V
VREF	AGND	-0.3 V to AVDD + 0.3 V
SENSE	AGND	-0.3 V to AVDD + 0.3 V
REFB, REFT	AGND	-0.3 V to AVDD + 0.3 V
CML	AGND	-0.3 V to AVDD + 0.3 V
VR	AGND	-0.3 V to AVDD + 0.3 V
OTR	DGND	-0.3 V to DRVDD + 0.3 V
D0 to D13	DGND	-0.3 V to DRVDD + 0.3 V
OEB	DGND	-0.3 V to DRVDD + 0.3 V
ENVIRONMENTAL¹		
Junction Temperature		150°C
Storage Temperature		-65°C to +150°C
Operating Temperature		-40°C to +85°C
Lead Temperature (10 sec)		300°C

¹ Typical thermal impedances; $\theta_{JA} = 50.0^{\circ}\text{C}/\text{W}$; $\theta_{JC} = 17.0^{\circ}\text{C}/\text{W}$. These measurements were taken on a 4-layer board in still air, in accordance with EIA/JESD51-7.

Stresses above those listed under Absolute Maximum Ratings may cause permanent damage to the device. This is a stress rating only; functional operation of the device at these or any other conditions above those indicated in the operational sections of this specification is not implied. Exposure to absolute maximum ratings for extended periods may affect device reliability.

EXPLANATION OF TEST LEVELS

Table 6.

Test Level	Description
I	100% production tested.
II	100% production tested at 25°C and sample tested at specified temperatures.
III	Sample tested only.
IV	Parameter is guaranteed by design and characterization testing.
V	Parameter is a typical value only.
VI	100% production tested at 25°C; guaranteed by design and characterization testing for industrial temperature range; 100% production tested at temperature extremes for military devices.

ESD CAUTION

ESD (electrostatic discharge) sensitive device. Electrostatic charges as high as 4000 V readily accumulate on the human body and test equipment and can discharge without detection. Although this product features proprietary ESD protection circuitry, permanent damage may occur on devices subjected to high energy electrostatic discharges. Therefore, proper ESD precautions are recommended to avoid performance degradation or loss of functionality.



PIN CONFIGURATION AND FUNCTION DESCRIPTIONS

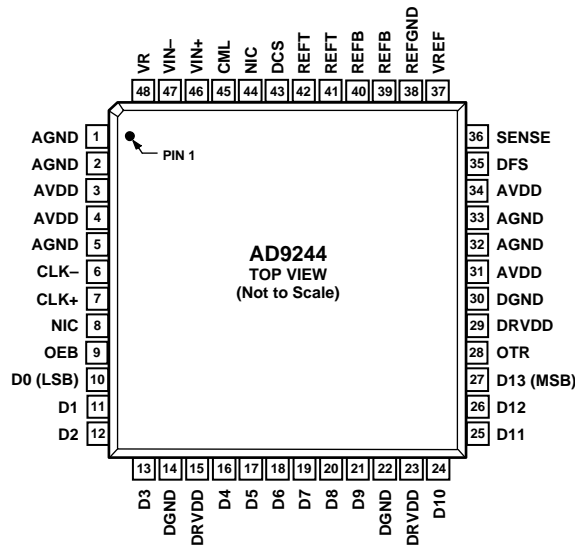

Figure 3. Pin Configuration

02404-003

Table 7. Pin Function Descriptions

Pin No.	Mnemonic	Description
1, 2, 5, 32, 33	AGND	Analog Ground.
3, 4, 31, 34	AVDD	Analog Supply Voltage.
6, 7	CLK-, CLK+	Differential Clock Inputs.
8, 44	NIC	No Internal Connection.
9	OEB	Digital Output Enable (Active Low).
10	D0 (LSB)	Least Significant Bit, Digital Output.
11 to 13, 16 to 21, 24 to 26	D1 to D3, D4 to D9, D10 to D12	Digital Outputs.
14, 22, 30	DGND	Digital Ground.
15, 23, 29	DRVDD	Digital Supply Voltage.
27	D13 (MSB)	Most Significant Bit, Digital Output.
28	OTR	Out-of-Range Indicator (Logic 1 Indicates OTR).
35	DFS	Data Format Select. Connect to AGND for straight binary, AVDD for twos complement.
36	SENSE	Internal Reference Control.
37	VREF	Internal Reference.
38	REFGND	Reference Ground.
39 to 42	REF B, REF T	Internal Reference Decoupling.
43	DCS	50% Duty Cycle Stabilizer. Connect to AVDD to activate 50% duty cycle stabilizer, AGND for external control of both clock edges.
45	CML	Common-Mode Reference ($0.5 \times AVDD$).
46, 47	VIN+, VIN-	Differential Analog Inputs.
48	VR	Internal Bias Decoupling.

TERMINOLOGY

Analog Bandwidth (Full Power Bandwidth)

The analog input frequency at which the spectral power of the fundamental frequency (as determined by the FFT analysis) is reduced by 3 dB.

Aperture Delay

The delay between the 50% point of the rising edge of the clock and the instant at which the analog input is sampled.

Aperture Uncertainty (Jitter)

The sample-to-sample variation in aperture delay.

Differential Analog Input Voltage Range

The peak-to-peak differential voltage must be applied to the converter to generate a full-scale response. Peak differential voltage is computed by observing the voltage on a single pin and subtracting the voltage from the other pin, which is 180° out of phase. Peak-to-peak differential is computed by rotating the input phase 180° and taking the peak measurement again. The difference is then found between the two peak measurements.

Differential Nonlinearity (DNL, No Missing Codes)

An ideal ADC exhibits code transitions that are exactly 1 LSB apart. DNL is the deviation from this ideal value. Guaranteed no missing codes to 14-bit resolution indicates that all 16,384 codes must be present over all operating ranges.

Dual-Tone SFDR¹

The ratio of the rms value of either input tone to the rms value of the peak spurious component. The peak spurious component may or may not be an IMD product.

Effective Number of Bits (ENOB)

The ENOB for a device for sine wave inputs at a given input frequency can be calculated directly from its measured SINAD by

$$N = (\text{SINAD} - 1.76)/6.02$$

Gain Error

The first code transition should occur at an analog value ½ LSB above negative full scale. The last code transition should occur at an analog value 1½ LSB below the nominal full scale. Gain error is the deviation of the actual difference between first and last code transitions and the ideal difference between first and last code transitions.

Common-Mode Rejection Ratio (CMRR)

Common-mode (CM) signals appearing on VIN+ and VIN- are ideally rejected by the differential front end of the ADC. With a full-scale CM signal driving both VIN+ and VIN-, CMRR is the ratio of the amplitude of the full-scale input CM signal to the amplitude of signal that is not rejected, expressed in dBFS.¹

IF Sampling

Due to the effects of aliasing, an ADC is not necessarily limited to Nyquist sampling. Higher sampled frequencies are aliased down into the first Nyquist zone ($DC - f_{\text{CLOCK}}/2$) on the output of the ADC. Care must be taken that the bandwidth of the sampled signal does not overlap Nyquist zones and alias onto itself. Nyquist sampling performance is limited by the bandwidth of the input SHA and clock jitter (noise caused by jitter increases as the input frequency increases).

Integral Nonlinearity (INL)

INL refers to the deviation of each individual code from a line drawn from negative full scale through positive full scale. The point used as negative full scale occurs ½ LSB before the first code transition. Positive full scale is defined as a level 1½ LSB beyond the last code transition. The deviation is measured from the middle of each particular code to the true straight line.

Minimum Conversion Rate

The clock rate at which the SNR of the lowest analog signal frequency drops by no more than 3 dB below the guaranteed limit.

Maximum Conversion Rate

The clock rate at which parametric testing is performed.

Nyquist Sampling

When the frequency components of the analog input are below the Nyquist frequency ($f_{\text{CLOCK}}/2$).

Out-of-Range Recovery Time

The time it takes for the ADC to reacquire the analog input after a transition from 10% above positive full scale to 10% above negative full scale, or from 10% below negative full scale to 10% below positive full scale.

Power Supply Rejection Ratio (PSRR)

The change in full scale from the value with the supply at its minimum limit to the value with the supply at its maximum limit.

Signal-to-Noise-and-Distortion (SINAD)¹

The ratio of the rms signal amplitude to the rms value of the sum of all other spectral components below the Nyquist frequency, including harmonics, but excluding dc.

Signal-to-Noise Ratio (SNR)¹

The ratio of the rms signal amplitude to the rms value of the sum of all other spectral components below the Nyquist frequency, excluding the first six harmonics and dc.

AD9244

Spurious-Free Dynamic Range (SFDR)¹

The difference in dB between the rms amplitude of the input signal and the peak spurious signal.

Temperature Drift

The temperature drift for offset error and gain error specifies the maximum change from initial (25°C) value to the value at T_{MIN} or T_{MAX} .

Total Harmonic Distortion (THD)¹

The ratio of the rms sum of the first six harmonic components to the rms value of the measured input signal.

Offset Error

The major carry transition should occur for an analog value $\frac{1}{2}$ LSB below $V_{\text{IN}+} = V_{\text{IN}-}$. Offset error is defined as the deviation of the actual transition from that point.

¹ AC specifications can be reported in dBc (degrades as signal levels are lowered) or in dBFS (always related back to converter full scale).

TYPICAL APPLICATION CIRCUITS

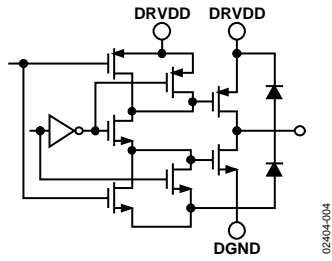

Figure 4. D0 to D13, OTR

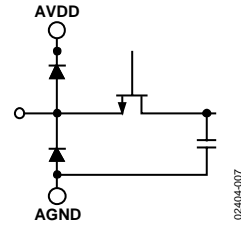

Figure 7. VIN+, VIN-

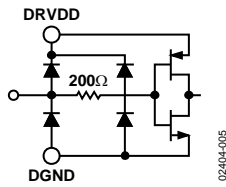

Figure 5. Three-State (OEB)

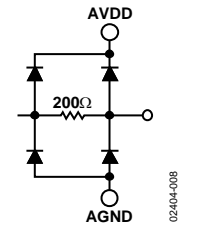

Figure 8. DFS, DCS, SENSE

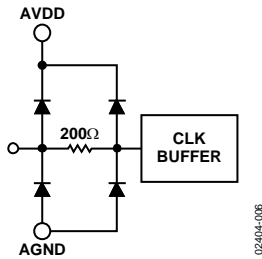

Figure 6. CLK+, CLK-

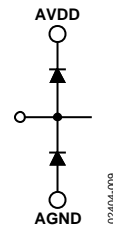

Figure 9. VREF, REFT, REFB, VR, CML

TYPICAL PERFORMANCE CHARACTERISTICS

AVDD = 5.0 V, DRVDD = 3.0 V, $f_{SAMPLE} = 65$ MSPS with CLK duty cycle stabilizer enabled, $T_A = 25^\circ\text{C}$, differential analog input, common-mode voltage (V_{CM}) = 2.5 V, input amplitude (A_{IN}) = -0.5 dBFS, VREF = 2.0 V external, FFT length = 8K, unless otherwise noted.

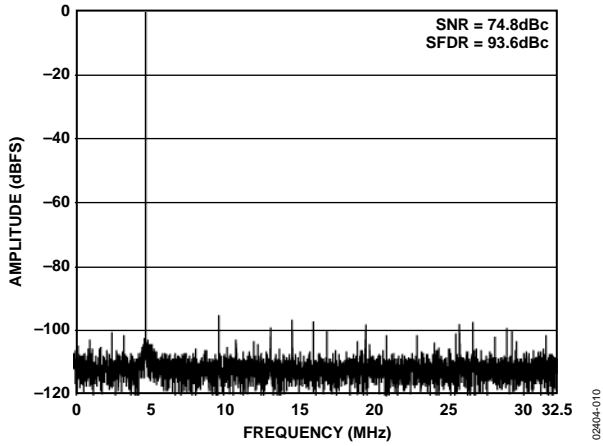

Figure 10. Single-Tone FFT, $f_{IN} = 5$ MHz

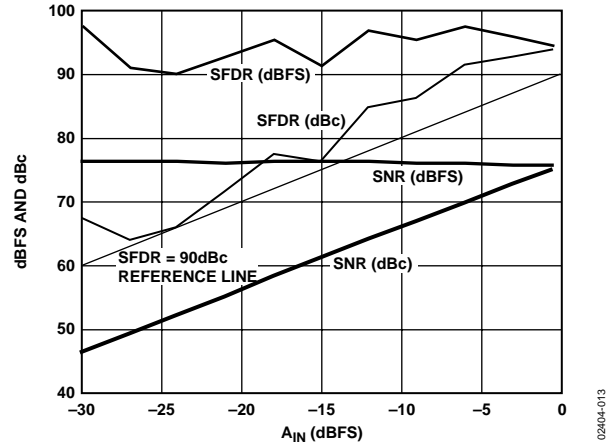

Figure 13. Single-Tone SNR/SFDR vs. A_{IN} , $f_{IN} = 5$ MHz

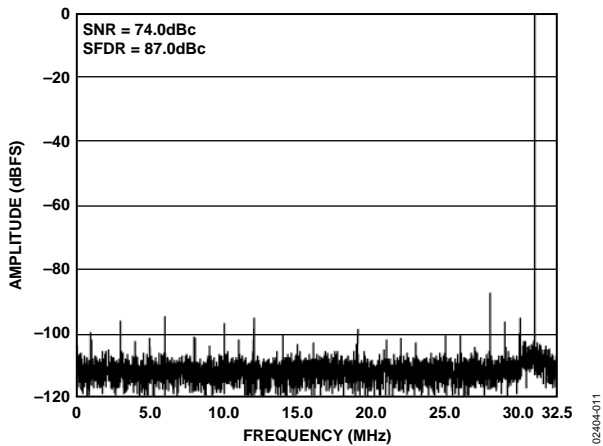

Figure 11. Single-Tone FFT, $f_{IN} = 31$ MHz

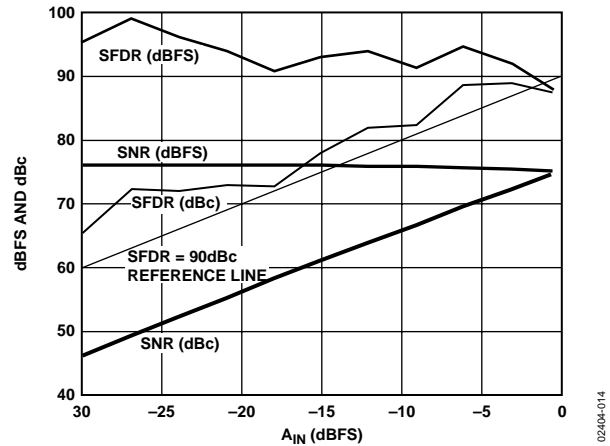

Figure 14. Single-Tone SNR/SFDR vs. A_{IN} , $f_{IN} = 31$ MHz

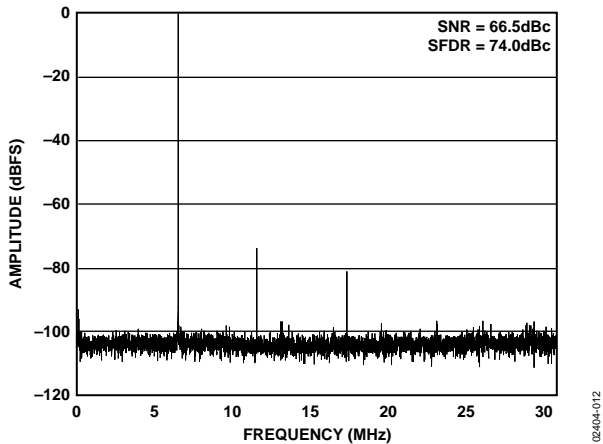

Figure 12. Single-Tone FFT, $f_{IN} = 190$ MHz, $f_{SAMPLE} = 61.44$ MSPS

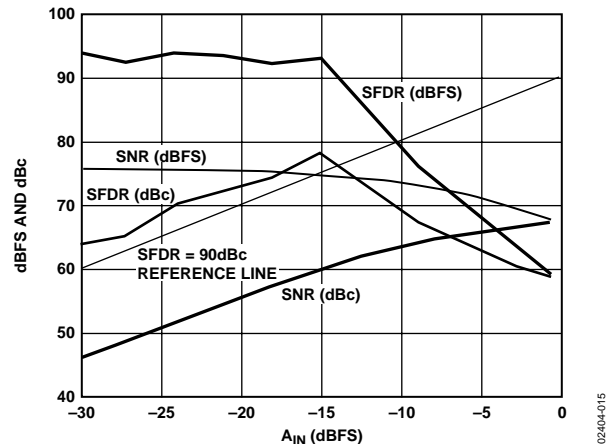

Figure 15. Single-Tone SNR/SFDR vs. A_{IN} , $f_{IN} = 190$ MHz, $f_{SAMPLE} = 61.44$ MSPS

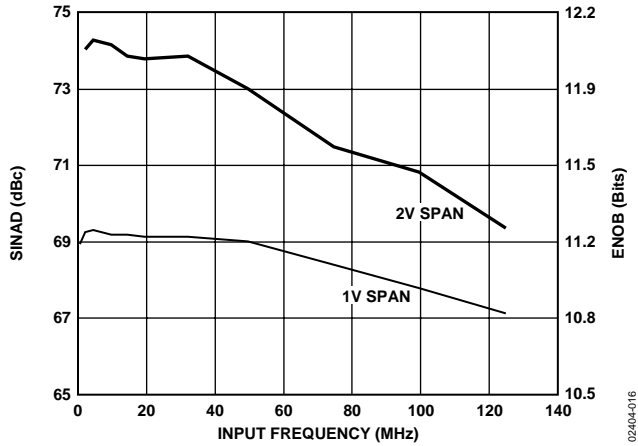

Figure 16. SINAD/ENOB vs. Input Frequency

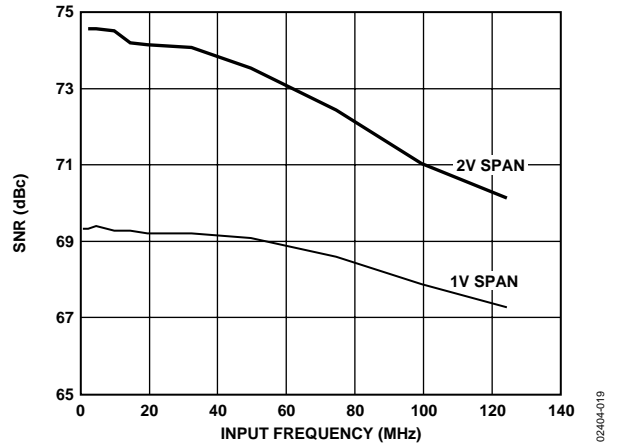

Figure 19. SNR vs. Input Frequency

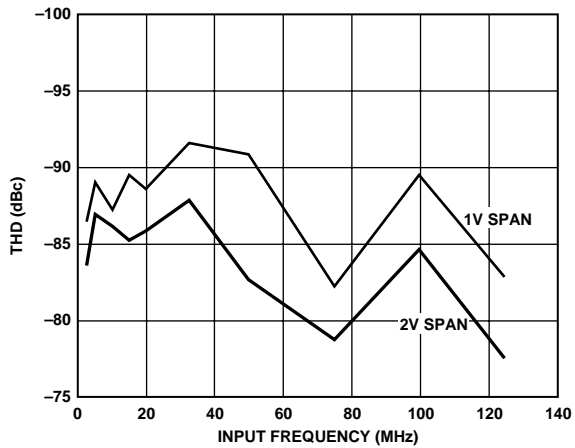

Figure 17. THD vs. Input Frequency

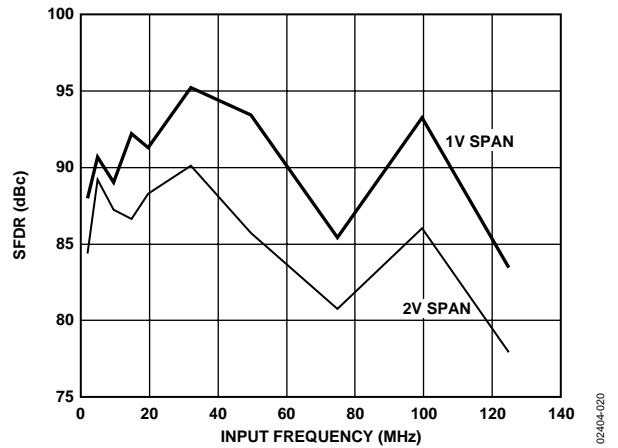

Figure 20. SFDR vs. Input Frequency

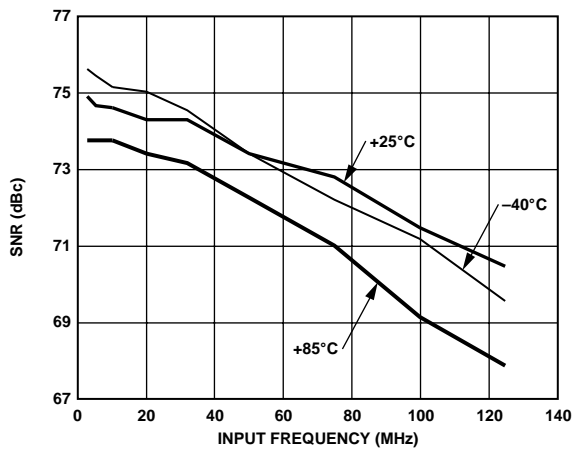

Figure 18. SNR vs. Temperature and Input Frequency, DCS Disabled

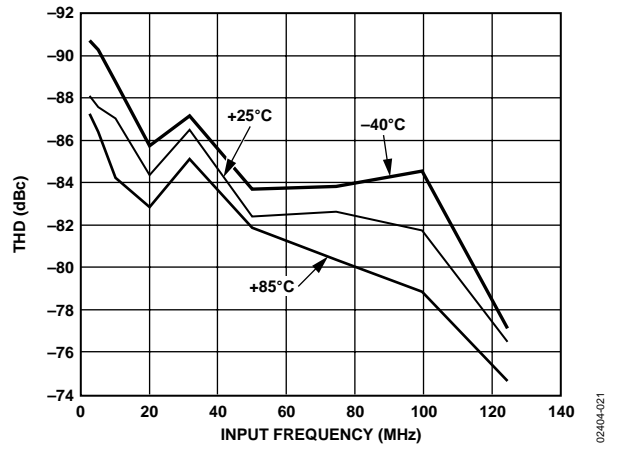

Figure 21. THD vs. Temperature and Input Frequency, DCS Disabled

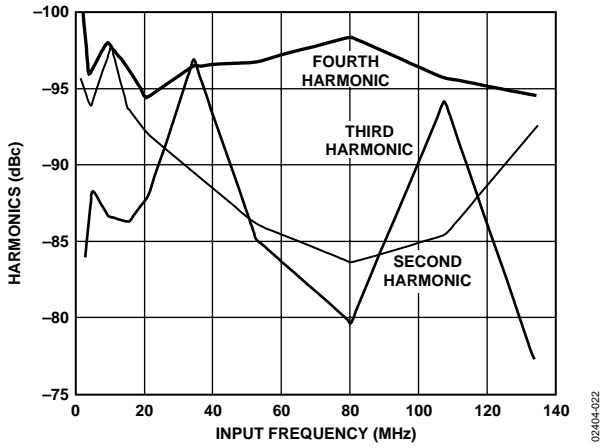

Figure 22. Harmonics vs. Input Frequency

02404-022

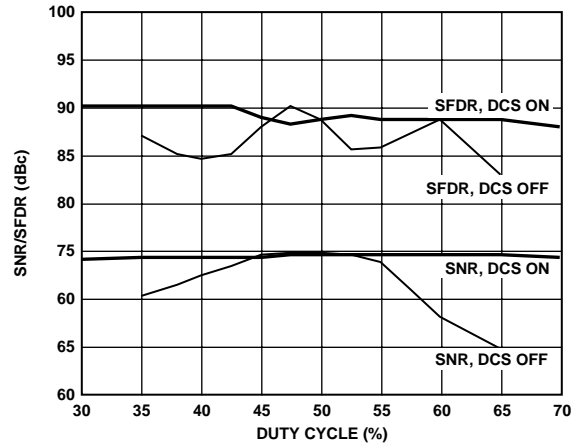

Figure 25. SNR/SFDR vs. Duty Cycle, $f_{IN} = 2.5$ MHz

02404-025

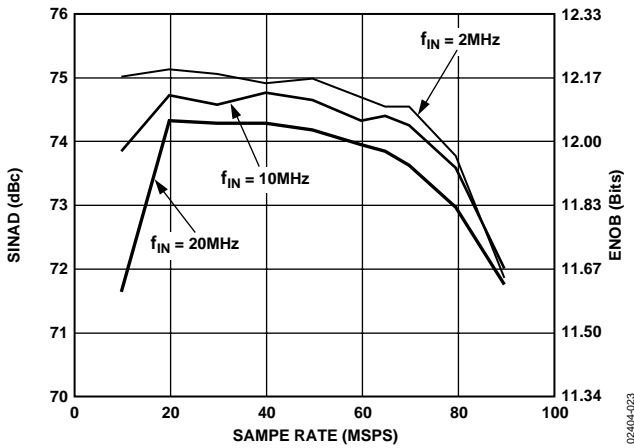

Figure 23. SINAD/ENOB vs. Sample Rate

02404-023

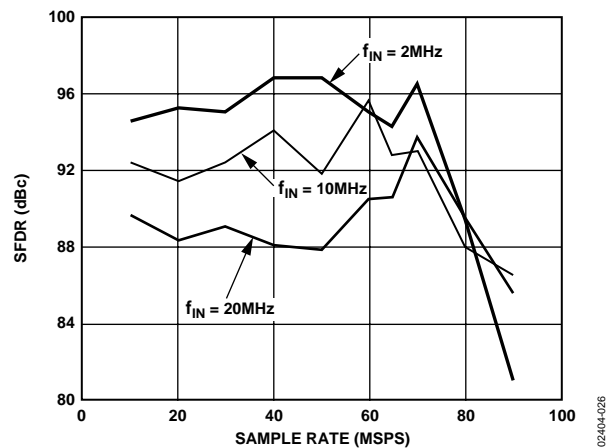

Figure 26. SFDR vs. Sample Rate

02404-026

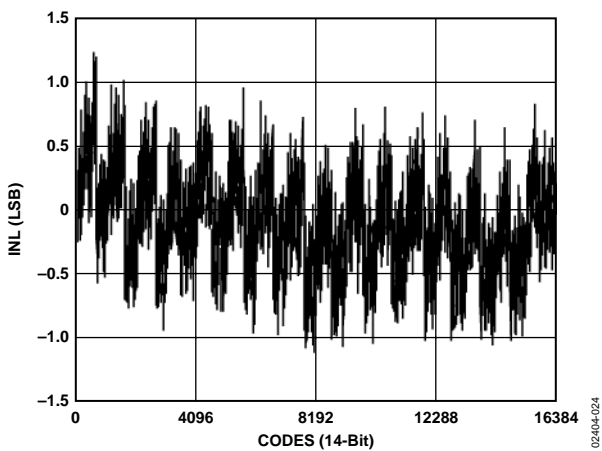

Figure 24. Typical INL

02404-024

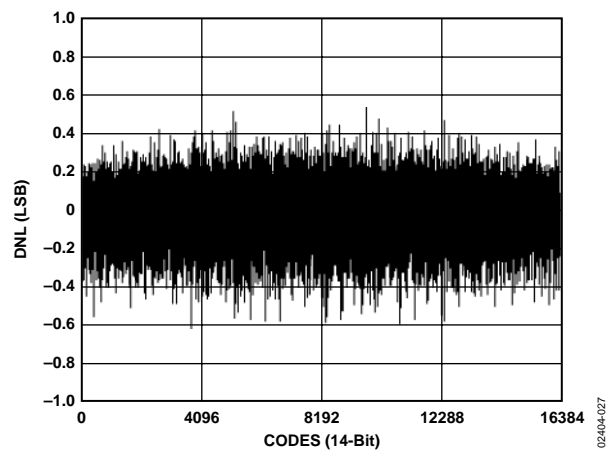

Figure 27. Typical DNL

02404-027

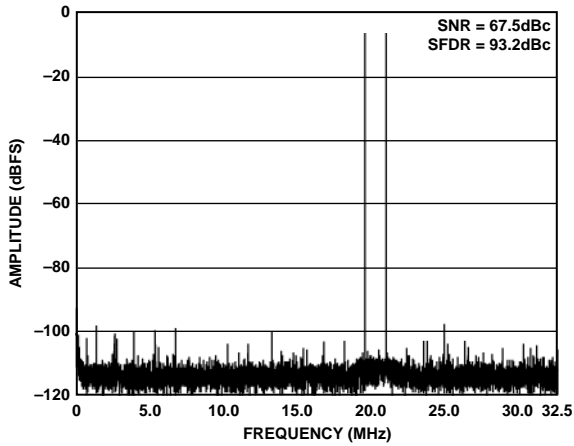

Figure 28. Dual-Tone FFT with $f_{IN-1} = 44.2$ MHz and $f_{IN-2} = 45.6$ MHz ($A_{IN1} = A_{IN2} = -6.5$ dBFS)

02404-028

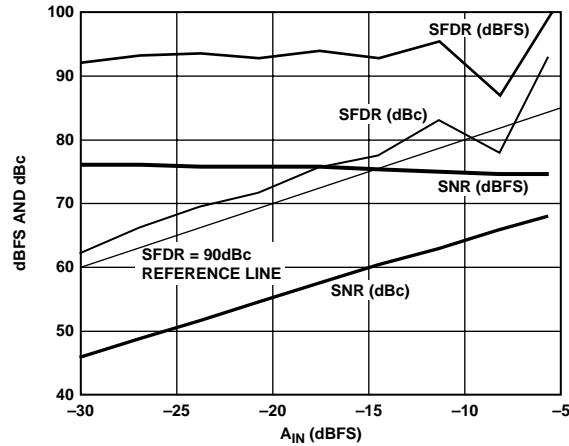

Figure 31. Dual-Tone SNR/SFDR vs. A_{IN} with $f_{IN-1} = 44.2$ MHz and $f_{IN-2} = 45.6$ MHz

02404-031

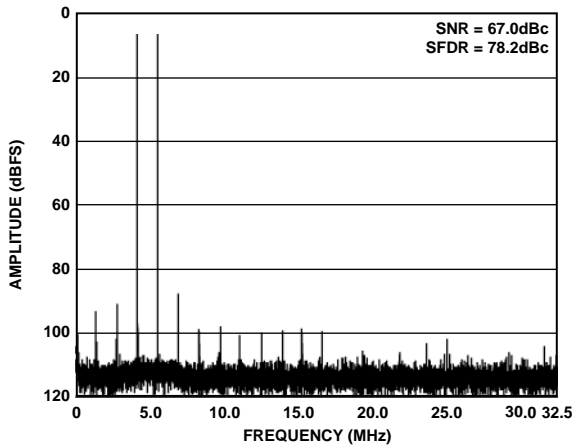

Figure 29. Dual-Tone FFT with $f_{IN-1} = 69.2$ MHz and $f_{IN-2} = 70.6$ MHz ($A_{IN1} = A_{IN2} = -6.5$ dBFS)

02404-029

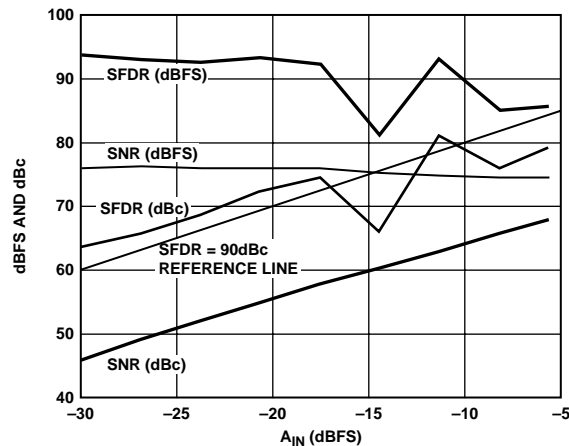

Figure 32. Dual-Tone SNR/SFDR vs. A_{IN} with $f_{IN-1} = 69.2$ MHz and $f_{IN-2} = 70.6$ MHz

02404-032

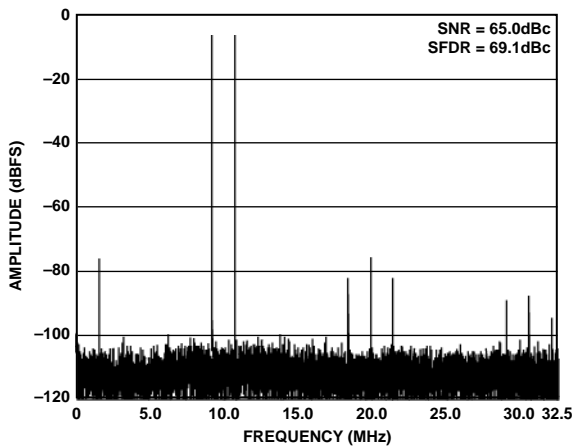

Figure 30. Dual-Tone FFT with $f_{IN-1} = 139.2$ MHz and $f_{IN-2} = 140.7$ MHz ($A_{IN1} = A_{IN2} = -6.5$ dBFS)

02404-030

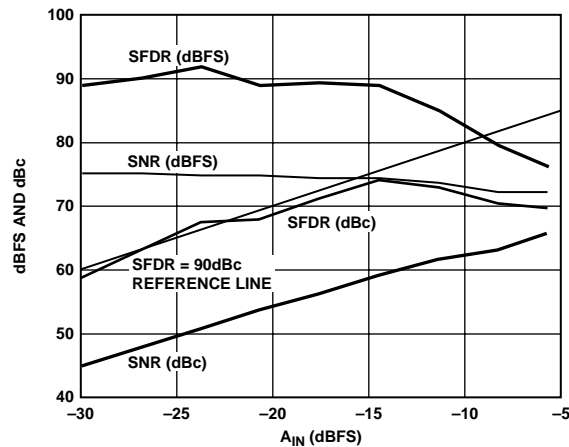

Figure 33. Dual-Tone SNR/SFDR vs. A_{IN} with $f_{IN-1} = 139.2$ MHz and $f_{IN-2} = 140.7$ MHz

02404-033

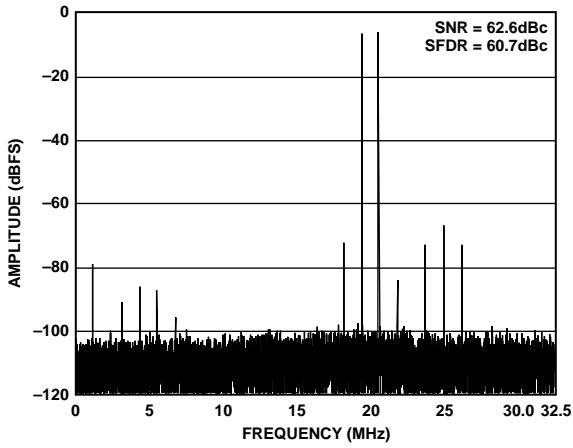

Figure 34. Dual-Tone with $f_{IN-1} = 239.1$ MHz and $f_{IN-2} = 240.7$ MHz ($A_{IN-1} = A_{IN-2} = -6.5$ dBFS)

02404-034

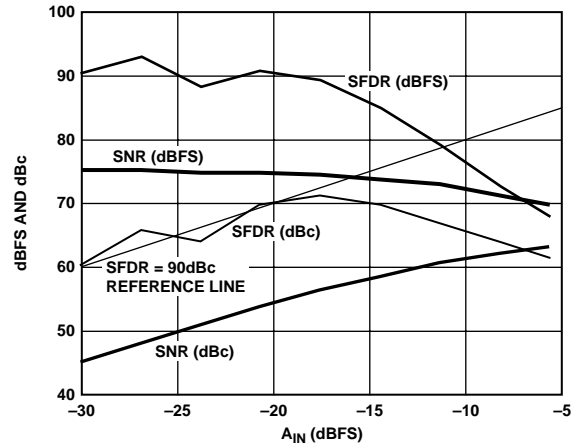

Figure 37. Dual-Tone SNR/SFDR vs. A_{IN} with $f_{IN-1} = 239.1$ MHz and $f_{IN-2} = 240.7$ MHz

02404-037

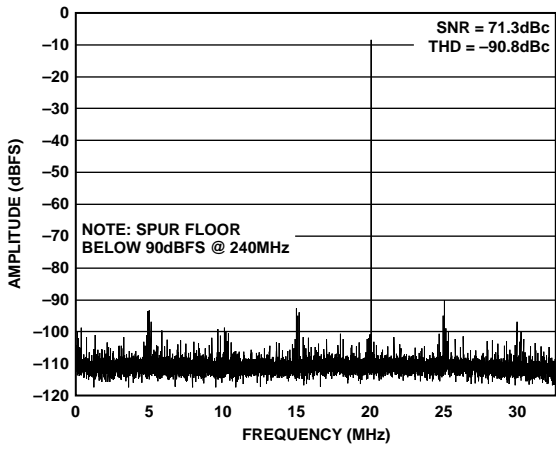

Figure 35. Driving ADC Inputs with Transformer and Balun, $f_{IN} = 240$ MHz, $A_{IN} = -8.5$ dBFS

02404-035

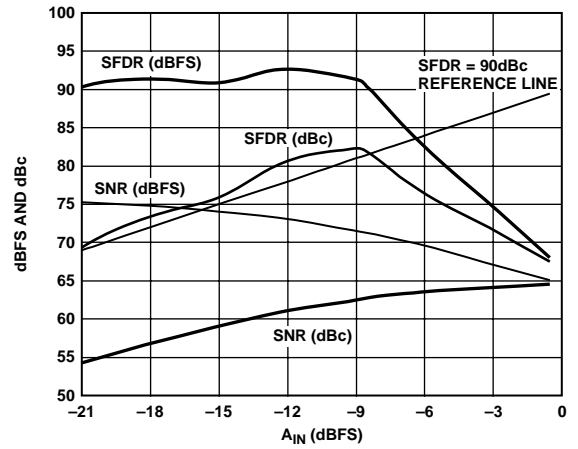

Figure 38. Driving ADC Inputs with Transformer and Balun SNR/SFDR vs. A_{IN} , $f_{IN} = 240$ MHz

02404-038

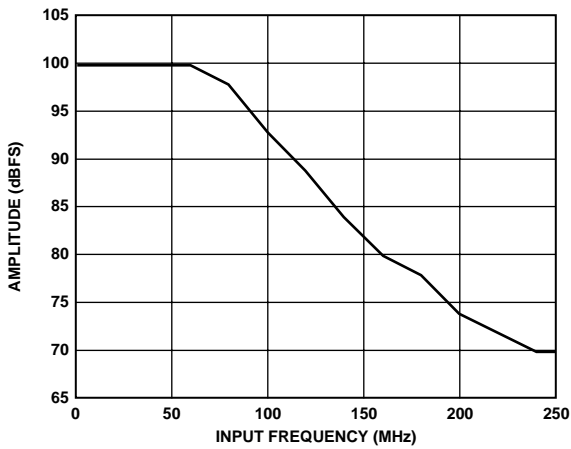

Figure 36. CMRR vs. Input Frequency ($A_{IN} = 0$ dBFS and CML = 2.5 V)

02404-036

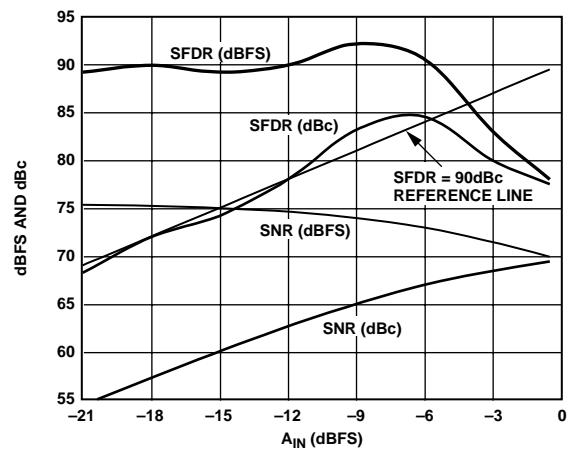

Figure 39. Driving ADC Inputs with Transformer and Balun SNR/SFDR vs. A_{IN} , $f_{IN} = 190$ MHz

02404-039

THEORY OF OPERATION

The AD9244 is a high performance, single-supply 14-bit ADC. In addition to high dynamic range Nyquist sampling, it is designed for excellent IF undersampling performance with an analog input as high as 240 MHz.

The AD9244 uses a calibrated 10-stage pipeline architecture with a patented, wideband, input sample-and-hold amplifier (SHA) implemented on a cost-effective CMOS process. Each stage of the pipeline, excluding the last, consists of a low resolution flash ADC along with a switched capacitor DAC and interstage residue amplifier (MDAC). The MDAC amplifies the difference between the reconstructed DAC output and the flash input for the next stage in the pipeline. One bit of redundancy is used in each of the stages to facilitate digital correction of flash errors. The last stage simply consists of a flash ADC.

The pipeline architecture allows a greater throughput rate at the expense of pipeline delay or latency. While the converter captures a new input sample every clock cycle, it takes eight clock cycles for the conversion to be fully processed and appear at the output, as illustrated in Figure 2. This latency is not a concern in many applications. The digital output, together with the OTR indicator, is latched into an output buffer to drive the output pins. The output drivers of the AD9244 can be configured to interface with 5 V or 3.3 V logic families.

The AD9244 has a duty clock stabilizer (DCS) that generates its own internal falling edge to create an internal 50% duty cycle clock, independent of the externally applied duty cycle. Control of straight binary or two's complement output format is accomplished with the DFS pin.

The ADC samples the analog input on the rising edge of the clock. While the clock is low, the input SHA is in sample mode. When the clock transitions to a high logic level, the SHA goes into the hold mode. System disturbances just prior to or immediately after the rising edge of the clock and/or excessive clock jitter can cause the SHA to acquire the wrong input value and should be minimized.

ANALOG INPUT AND REFERENCE OVERVIEW

The differential input span of the AD9244 is equal to the potential at the VREF pin. The VREF potential can be obtained from the internal AD9244 reference or an external source.

In differential applications, the center point of the input span is the common-mode level of the input signals. In single-ended applications, the center point is the dc potential applied to one input pin while the signal is applied to the opposite input pin. Figure 40 to Figure 42 show various system configurations.

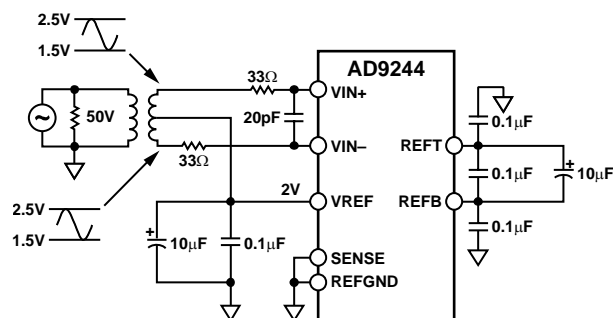

Figure 40. 2 V p-p Differential Input, Common-Mode Voltage = 2 V

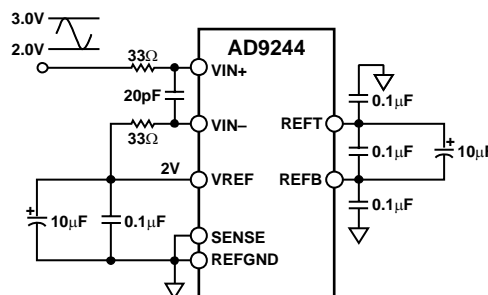

Figure 41. 2 V p-p Single-Ended Input, Common-Mode Voltage = 2 V

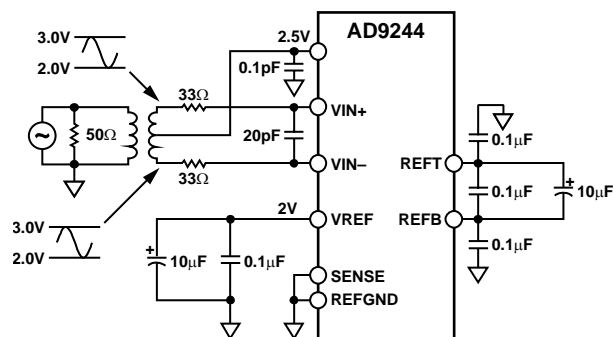

Figure 42. 2 V p-p Differential Input, Common-Mode Voltage = 2.5 V

Figure 43 is a simplified model of the AD9244 analog input, showing the relationship between the analog inputs, VIN+, VIN-, and the reference voltage, VREF. Note that this is only a symbolic model and that no actual negative voltages exist inside the AD9244. Similar to the voltages applied to the top and bottom of the resistor ladder in a flash ADC, the value $VREF/2$ defines the minimum and maximum input voltages to the ADC core.

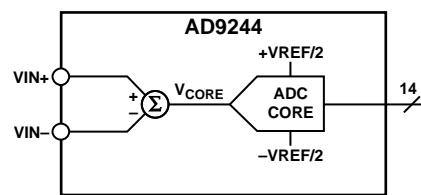

Figure 43. Equivalent Analog Input of AD9244

AD9244

A differential input structure allows the user to easily configure the inputs for either single-ended or differential operation. The ADC's input structure allows the dc offset of the input signal to be varied independent of the input span of the converter. Specifically, the input to the ADC core can be defined as the difference of the voltages applied at the VIN+ and VIN- input pins.

Therefore, the equation

$$V_{CORE} = (VIN+) - (VIN-) \quad (1)$$

defines the output of the differential input stage and provides the input to the ADC core. The voltage, V_{CORE} , must satisfy the condition

$$-VREF/2 < V_{CORE} < VREF/2 \quad (2)$$

where $VREF$ is the voltage at the $VREF$ pin.

In addition to the limitations placed on the input voltages VIN+ and VIN- by Equation 1 and Equation 2, boundaries on the inputs also exist based on the power supply voltages according to the conditions

$$AGND - 0.3 \text{ V} < VIN+ < AVDD + 0.3 \text{ V} \quad (3)$$

$$AGND - 0.3 \text{ V} < VIN- < AVDD + 0.3 \text{ V} \quad (4)$$

where:

AGND is nominally 0 V.

AVDD is nominally 5 V.

The range of valid inputs for VIN+ and VIN- is any combination that satisfies Equation 2, Equation 3, and Equation 4.

For additional information showing the relationship between VIN+, VIN-, VREF, and the analog input range of the AD9244, see Table 8 and Table 9.

ANALOG INPUT OPERATION

Figure 44 shows the equivalent analog input of the AD9244, which consists of a 750 MHz differential SHA. The differential input structure of the SHA is flexible, allowing the device to be configured for either a differential or single-ended input. The analog inputs VIN+ and VIN- are interchangeable, with the exception that reversing the inputs to the VIN+ and VIN- pins results in a data inversion (complementing the output word).

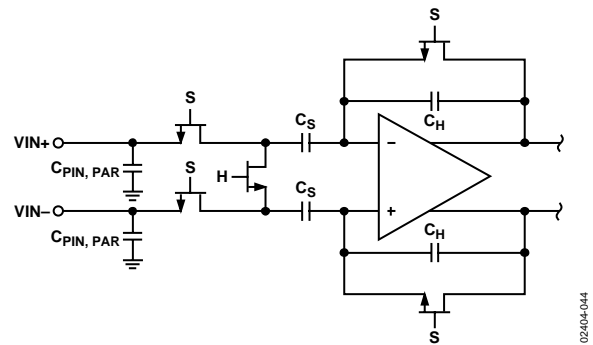

Figure 44. Analog Input of AD9244 SHA

Table 8. Analog Input Configuration Summary

Input Connection	Coupling	Input Span (V)	Input Range (V)		Input CM Voltage (V)	Comments
			VIN+ ¹	VIN- ¹		
Single-Ended	DC or AC	1.0	0.5 to 1.5	1.0	1.0	Best for stepped input response applications. Optimum noise performance for single-ended mode often requires low distortion op amp with VCC > 5 V due to its headroom issues.
		2.0	1 to 3	2.0	2.0	
Differential	DC or AC	1.0	2.25 to 2.75	2.75 to 2.25	2.5	Optimum full-scale THD and SFDR performance well beyond the ADC's Nyquist frequency. Optimum noise performance for differential mode. Preferred mode for applications.
		2.0	2.0 to 3.0	3.0 to 2.0	2.5	

¹VIN+ and VIN- can be interchanged if data inversion is required.

Table 9. Reference Configuration Summary

Reference Operating Mode	Connect	To	Resulting VREF (V)	Input Span (VIN+ - VIN-) (V p-p)
Internal	SENSE	VREF	1	1
Internal	SENSE	AGND	2	2
Internal	R1	VREF and SENSE	1 ≤ VREF ≤ 2.0	1 ≤ SPAN ≤ 2
	R2	SENSE and REFGND	VREF = (1 + R1/R2)	(SPAN = VREF)
External	SENSE	AVDD	1 ≤ VREF ≤ 2.0	SPAN = EXTERNAL REF
	VREF	EXTERNAL REF		

The optimum noise and dc linearity performance for either differential or single-ended inputs is achieved with the largest input signal voltage span (that is, 2 V input span) and matched input impedance for VIN+ and VIN-. Only a slight degradation in dc linearity performance exists between the 2 V and 1 V input spans; however, the SNR is lower in the 1 V input span.

When the ADC is driven by an op amp and a capacitive load is switched onto the output of the op amp, the output momentarily drops due to its effective output impedance. As the output recovers, ringing can occur. To remedy the situation, a series resistor, R_S , can be inserted between the op amp and the SHA input, as shown in Figure 45. A shunt capacitance also acts like a charge reservoir, sinking or sourcing the additional charge required by the sampling capacitor, C_S , further reducing current transients seen at the op amp's output.

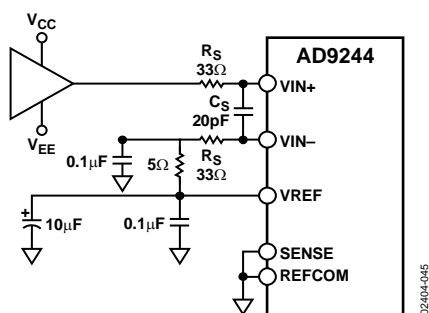

Figure 45. Resistor Isolating SHA Input from Op Amp

The optimum size of this resistor is dependent on several factors, including the ADC sampling rate, the selected op amp, and the particular application. In most applications, a 30 Ω to 100 Ω resistor is sufficient.

For noise-sensitive applications, the very high bandwidth of the AD9244 can be detrimental, and the addition of a series resistor and/or shunt capacitor can help limit the wideband noise at the ADC's input by forming a low-pass filter. The source impedance driving VIN+ and VIN- should be matched. Failure to provide matching can result in degradation of the SNR, THD, and SFDR performance.

Single-Ended Input Configuration

A single-ended input can provide adequate performance in cost-sensitive applications. In this configuration, there is degradation in distortion performance due to large input common-mode swing. However, if the source impedances on each input are matched, there should be little effect on SNR performance.

The internal reference can be used to drive the inputs. Figure 45 shows an example of VREF driving VIN-. In this operating mode, a 5 Ω resistor and a 0.1 μF capacitor must be connected between VREF and VIN-, as shown in Figure 45, to limit the reference noise sampled by the analog input.

Differentially Driving the Analog Inputs

The AD9244 has a very flexible input structure, allowing it to interface with single-ended or differential inputs.

The optimum mode of operation, analog input range, and associated interface circuitry is determined by the particular application's performance requirements as well as power supply options.

Differential operation requires that VIN+ and VIN- be simultaneously driven with two equal signals that are 180° out of phase with each other.

Differential modes of operation (ac-coupled or dc-coupled input) provide the best SFDR performance over a wide frequency range. They should be considered for the most demanding spectral-based applications; that is, direct IF conversion to digital.

Because not all applications have a signal precondition for differential operation, there is often a need to perform a single-ended-to-differential conversion. In systems that do not require dc coupling, an RF transformer with a center tap is the best method for generating differential input signals for the AD9244. This provides the benefit of operating the ADC in the differential mode without contributing additional noise or distortion. An RF transformer also has the added benefit of providing electrical isolation between the signal source and the ADC.

The differential input characterization was performed using the configuration in Figure 46. The circuit uses a Mini-Circuits® RF transformer, model T1-1T, which has an impedance ratio of 1:1. This circuit assumes that the signal source has a 50 Ω source impedance. The secondary center tap of the transformer allows a dc common-mode voltage to be added to the differential input signal. In Figure 46, the center tap is connected to a resistor divider providing a half supply voltage. It could also be connected to the CML pin of the AD9244. For IF sampling applications ($70 \text{ MHz} < f_{IN} < 200 \text{ MHz}$), it is recommended that the 20 pF differential capacitor between VIN+ and VIN- be reduced or removed.

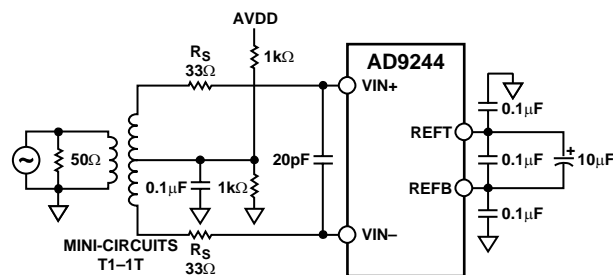

Figure 46. Transformer-Coupled Input

AD9244

The circuit in Figure 47 shows a method for applying a differential, direct-coupled signal to the AD9244. An AD8138 amplifier is used to derive a differential signal from a single-ended signal.

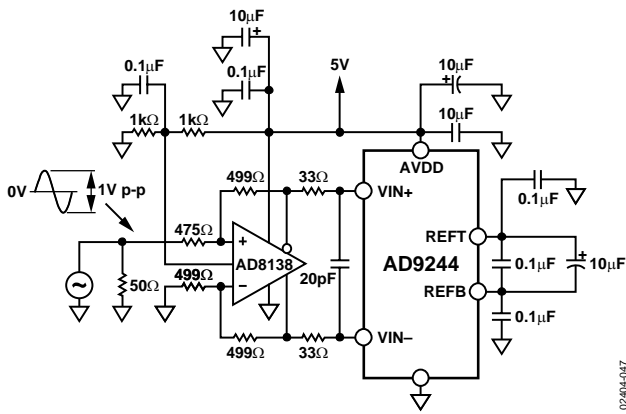

Figure 47. Direct-Coupled Drive Circuit with AD8138 Differential Op Amp

REFERENCE OPERATION

The AD9244 contains a band gap reference that provides a pin-strappable option to generate either a 1 V or 2 V output. With the addition of two external resistors, the user can generate reference voltages between 1 V and 2 V. Another alternative is to use an external reference for designs requiring enhanced accuracy and/or drift performance, as described later in this section. Figure 48 shows a simplified model of the internal voltage reference of the AD9244. A reference amplifier buffers a 1 V fixed reference. The output from the reference amplifier, A1, appears on the VREF pin. As stated earlier, the voltage on the VREF pin determines the full-scale differential input span of the ADC.

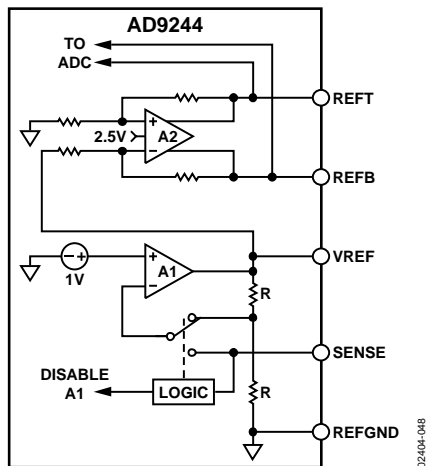
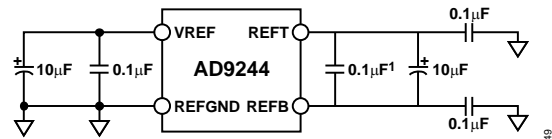

Figure 48. Equivalent Reference Circuit

The voltage appearing at the VREF pin and the state of the internal reference amplifier, A1, are determined by the voltage present at the SENSE pin. The logic circuitry contains comparators that monitor the voltage at the SENSE pin. The various reference modes are summarized in Table 9 and are described in the next few sections.

The actual reference voltages used by the internal circuitry of the AD9244 appear on the REFT and REFB pins. The voltages on these pins are symmetrical about midsupply or CML. For proper operation, it is necessary to add a capacitor network to decouple these pins. Figure 49 shows the recommended decoupling network. The turn-on time of the reference voltage appearing between REFT and REFB is approximately 10 ms and should be taken into consideration in any power-down mode of operation. The VREF pin should be bypassed to the REFND pin with a 10 μF tantalum capacitor in parallel with a low inductance 0.1 μF ceramic capacitor.



1 LOCATE AS CLOSE AS POSSIBLE TO REFT/REFB PINS.

Figure 49. Reference Decoupling

Pin-Programmable Reference

By shorting the VREF pin directly to the SENSE pin, the internal reference amplifier is placed in a unity gain mode, and the resulting VREF output is 1 V. By shorting the SENSE pin directly to the REFND pin, the internal reference amplifier is configured for a gain of 2, and the resulting VREF output is 2 V.

Resistor-Programmable Reference

Figure 50 shows an example of how to generate a reference voltage other than 1.0 V or 2.0 V with the addition of two external resistors. Use the equation

$$VREF = 1 V \times (1 + R1/R2) \quad (5)$$

to determine the appropriate values for R1 and R2. These resistors should be in the 2 kΩ to 10 kΩ range. For the example shown, R1 equals 2.5 kΩ and R2 equals 5 kΩ. From the previous equation, the resulting reference voltage on the VREF pin is 1.5 V. This sets the differential input span to 1.5 V p-p. The midscale voltage can also be set to VREF by connecting VIN- to VREF.

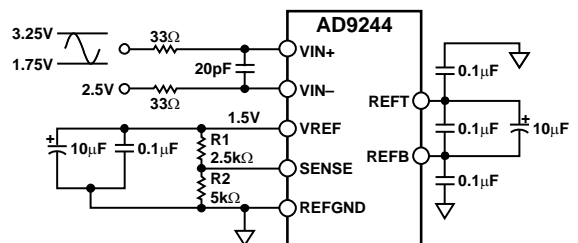

Figure 50. Resistor-Programmable Reference (1.5 V p-p Input Span, Differential Input with $V_{CM} = 2.5 V$)

Using an External Reference

To use an external reference, the internal reference must be disabled by connecting the SENSE pin to AVDD. The AD9244 contains an internal reference buffer, A2 (see Figure 48), that simplifies the drive requirements of an external reference. The external reference must be able to drive a 5 k Ω ($\pm 20\%$) load. The bandwidth of the reference is deliberately left small to minimize the reference noise contribution. As a result, it is not possible to drive VREF externally with high frequencies.

Figure 51 shows an example of an external reference driving both VIN $^-$ and VREF. In this case, both the common-mode voltage and input span are directly dependent on the value of VREF. Both the input span and the center of the input span are equal to the external VREF. Thus, the valid input range extends from (VREF + VREF/2) to (VREF – VREF/2). For example, if the Precision Reference Part REF191, a 2.048 V external reference, is used, the input span is 2.048 V. In this case, 1 LSB of the AD9244 corresponds to 0.125 mV.

It is essential that a minimum of a 10 μ F capacitor, in parallel with a 0.1 μ F low inductance ceramic capacitor, decouple the reference output to AGND.

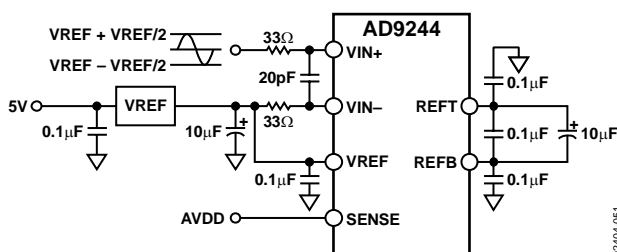

Figure 51. Using an External Reference

Digital Outputs

Table 10 details the relationship among the ADC input, OTR, and digital output format.

Data Format Select (DFS)

The AD9244 can be programmed for straight binary or twos complement data on the digital outputs. Connect the DFS pin to AGND for straight binary and to AVDD for twos complement.

Digital Output Driver Considerations

The AD9244 output drivers can be configured to interface with 5 V or 3.3 V logic families by setting DRVDD to 5 V or 3.3 V, respectively. The output drivers are sized to provide sufficient output current to drive a wide variety of logic families.

However, large drive currents tend to cause glitches on the supplies and can affect converter performance. Applications requiring the ADC to drive large capacitive loads or large fanouts can require external buffers or latches.

DIGITAL INPUTS AND OUTPUTS

Table 10. Output Data Format

Input (V)	Condition (V)	Binary Output Mode	Twos Complement Mode	OTR
VIN+ – VIN–	< –VREF/2 – 0.5 LSB	00 0000 0000 0000	10 0000 0000 0000	1
VIN+ – VIN–	= –VREF/2	00 0000 0000 0000	10 0000 0000 0000	0
VIN+ – VIN–	= 0	10 0000 0000 0000	00 0000 0000 0000	0
VIN+ – VIN–	= +VREF/2 – 1.0 LSB	11 1111 1111 1111	01 1111 1111 1111	0
VIN+ – VIN–	> +VREF/2 – 0.5 LSB	11 1111 1111 1111	01 1111 1111 1111	1

Out of Range (OTR)

An out-of-range condition exists when the analog input voltage is beyond the input range of the ADC. OTR is a digital output that is updated along with the data output corresponding to the particular sampled input voltage. Thus, OTR has the same pipeline latency as the digital data. OTR is low when the analog input voltage is within the analog input range and high when the analog input voltage exceeds the input range, as shown in Figure 52. OTR remains high until the analog input returns to within the input range and another conversion is completed.

By logically AND'ing OTR with the MSB and its complement, overrange high or underrange low conditions can be detected. Table 11 is a truth table for the overrange/underrange circuit in Figure 53, which uses NAND gates. Systems requiring programmable gain conditioning of the AD9244 can after eight clock cycles detect an OTR condition, thus eliminating gain selection iterations. In addition, OTR can be used for digital offset and gain calibration.

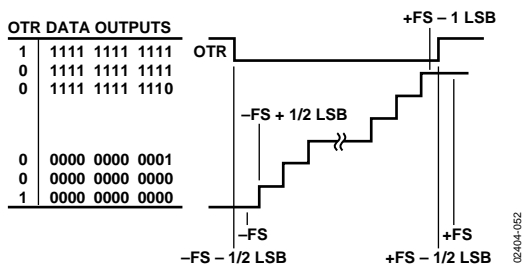

Figure 52. OTR Relation to Input Voltage and Output Data

Table 11. Output Data Format

OTR	MSB	Analog Input Is
0	0	Within range
0	1	Within range
1	0	Underrange
1	1	Overrange

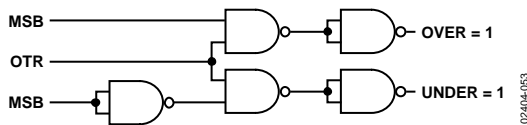

Figure 53. Overrange/Underrange Logic

Digital Output Enable Function (OEB)

The AD9244 has three-state ability. If the OEB pin is low, the output data drivers are enabled. If the OEB pin is high, the output data drivers are placed in a high impedance state. The three-state ability is not intended for rapid access to the data bus. Note that OEB is referenced to the digital supplies (DRVDD) and should not exceed that supply voltage.

Clock Overview

The AD9244 has a flexible clock interface that accepts either a single-ended or differential clock. An internal bias voltage facilitates ac coupling using two external capacitors. To remain backward compatible with the single-pin clock scheme of the AD9226, the AD9244 can be operated with a dc-coupled, single-pin clock by grounding the CLK- pin and driving CLK+.

When the CLK- pin is not grounded, the CLK+ and CLK- pins function as a differential clock receiver. When CLK+ is greater than CLK-, the SHA is in hold mode; when CLK+ is less than CLK-, the SHA is in track mode (see Figure 54 for timing). The rising edge of the clock (CLK+ - CLK-) switches the SHA from track to hold, and timing jitter on this transition should be minimized, especially for high frequency analog inputs.

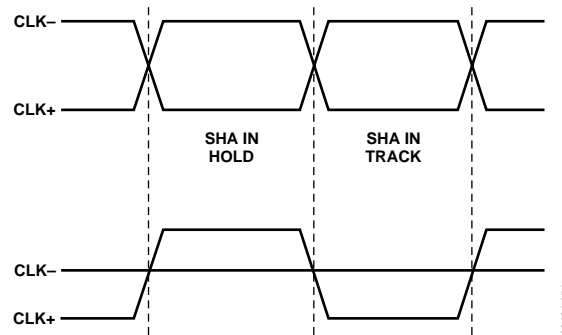

Figure 54. SHA Timing

It is often difficult to maintain a 50% duty cycle to the ADC, especially when driving the clock with a single-ended or sine wave input. To ease the constraint of providing an accurate 50% clock, the ADC has an optional internal duty cycle stabilizer (DCS) that allows the rising clock edge to pass through with minimal jitter, and interpolates the falling edge, independent of the input clock falling edge. The DCS is described in greater detail in the Clock Stabilizer (DCS) section.

Clock Input Modes

Figure 55 to Figure 59 illustrate the modes of operation of the clock receiver. Figure 55 shows a differential clock directly coupled to CLK+ and CLK-. In this mode, the common mode of the CLK+ and CLK- signals should be close to 1.6 V. Figure 56 illustrates a single-ended clock input. The capacitor decouples the internal bias voltage on the CLK- pin (about 1.6 V), establishing a threshold for the CLK+ pin. Figure 57 provides backward compatibility with the AD9226. In this mode, CLK- is grounded, and the threshold for CLK+ is 1.5 V. Figure 58 shows a differential clock ac-coupled by connecting through two capacitors. AC coupling a single-ended clock can also be accomplished using the circuit in Figure 59.

When using the differential clock circuits of Figure 55 or Figure 58, if CLK- drops below 250 mV, the mode of the clock receiver may change, causing conversion errors. It is essential that CLK- remains above 250 mV when the clock is ac-coupled or dc-coupled.

Clock Input Considerations

The analog input is sampled on the rising edge of the clock. Timing variations, or jitter, on this edge causes the sampled input voltage to be in error by an amount proportional to the slew rate of the input signal and to the amount of the timing variation. Thus, to maintain the excellent high frequency SFDR and SNR characteristics of the AD9244, it is essential that the clock edge be kept as clean as possible.

The clock should be treated like an analog signal. Clock drivers should not share supplies with digital logic or noisy circuits. The clock traces should not run parallel to noisy traces. Using a pair of symmetrically routed, differential clock signals can help to provide immunity from common-mode noise coupled from the environment.

The clock receiver functions like a differential comparator. At the CLK inputs, a slowly changing clock signal results in more jitter than a rapidly changing one. Driving the clock with a low amplitude sine wave input is not recommended. Running a high speed clock through a divider circuit provides a fast rise/fall time, resulting in the lowest jitter in most systems.

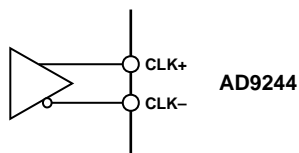

Figure 55. Differential Clock Input, DC-Coupled

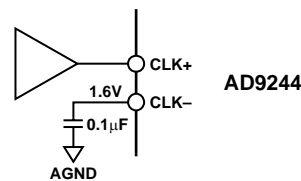

Figure 56. Single-Ended Clock Input, DC-Coupled

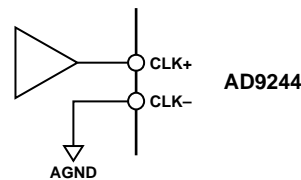

Figure 57. Single-Ended Input, Retains Pin Compatibility with AD9226

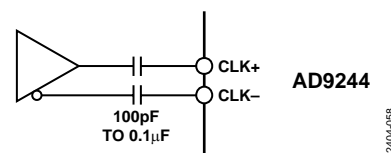

Figure 58. Differential Clock Input, AC-Coupled

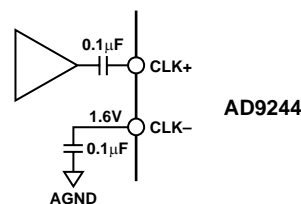

Figure 59. Single-Ended Clock Input, AC-Coupled

Clock Power Dissipation

Most of the power dissipated by the AD9244 is from the analog power supplies. However, lower clock speeds reduce digital supply current. Figure 60 shows the relationship between power and clock rate.

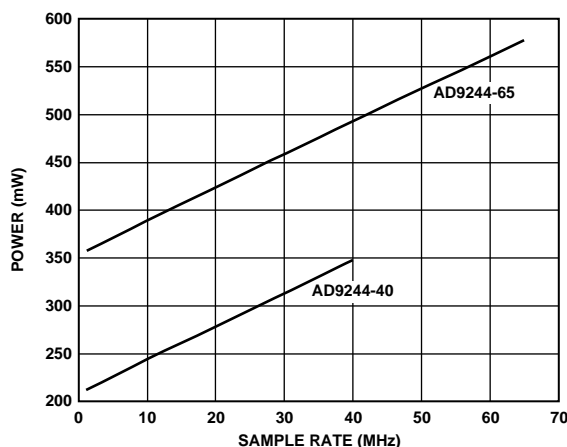

Figure 60. Power Consumption vs. Sample Rate

Clock Stabilizer (DCS)

The clock stabilizer circuit in the AD9244 desensitizes the ADC from clock duty cycle variations. System clock constraints are eased by internally restoring the clock duty cycle to 50%, independent of the clock input duty cycle. Low jitter on the rising edge (sampling edge) of the clock is preserved while the falling edge is generated on-chip.

It may be desirable to disable the clock stabilizer, or necessary when the clock frequency is varied or completely stopped. Note that stopping the clock is not recommended with ac-coupled clocks. Once the clock frequency is changed, more than 100 clock cycles may be required for the clock stabilizer to settle to the new speed. When the stabilizer is disabled, the internal switching is directly affected by the clock state. If CLK+ is high, the SHA is in hold mode; if CLK+ is low, the SHA is in track mode. Figure 25 shows the benefits of using the clock stabilizer. Connecting DCS to AVDD implements the internal clock stabilization function in the AD9244. If the DCS pin is connected to ground, the AD9244 uses both edges of the external clock in its internal timing circuitry (see the Specifications section for timing requirements).

Grounding and Decoupling

Analog and Digital Grounding

Proper grounding is essential in high speed, high resolution systems. Multilayer printed circuit boards (PCBs) are recommended to provide optimal grounding and power distribution.

The use of power and ground planes offers distinct advantages, including:

- The minimization of the loop area encompassed by a signal and its return path
- The minimization of the impedance associated with ground and power paths
- The inherent distributed capacitor formed by the power plane, PCB material, and ground plane

It is important to design a layout that minimizes noise from coupling onto the input signal. Digital input signals should not be run in parallel with input signal traces and should be routed away from the input circuitry. While the AD9244 features separate analog and digital ground pins, it should be treated as an analog component. The AGND and DGND pins must be joined together directly under the AD9244. A solid ground plane under the ADC is acceptable if the power and ground return currents are carefully managed.

Analog Supply Decoupling

The AD9244 features separate analog and digital supply and ground circuits, helping to minimize digital corruption of sensitive analog signals. In general, AVDD (analog power) should be decoupled to AGND (analog ground). The AVDD and AGND pins are adjacent to one another. Figure 61 shows the recommended decoupling for each pair of analog supplies; 0.1 μ F ceramic chip and 10 μ F tantalum capacitors should provide adequately low impedance over a wide frequency range. The decoupling capacitors (especially 0.1 μ F) should be located as close to the pins as possible.

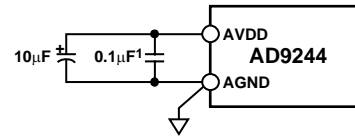

¹LOCATE AS CLOSE AS POSSIBLE TO SUPPLY PINS. 02404-061

Figure 61. Analog Supply Decoupling

Digital Supply Decoupling

The digital activity on the AD9244 falls into two categories: correction logic and output drivers. The internal correction logic draws relatively small surges of current, mainly during the clock transitions. The output drivers draw large current impulses when the output bits change state. The size and duration of these currents are a function of the load on the output bits; large capacitive loads should be avoided.

For the digital decoupling shown in Figure 62, 0.1 μ F ceramic chip and 10 μ F tantalum capacitors are appropriate. The decoupling capacitors (especially 0.1 μ F) should be located as close to the pins as possible. Reasonable capacitive loads on the data pins are less than 20 pF per bit. Applications involving greater digital loads should consider increasing the digital decoupling and/or using external buffers/latches.

A complete decoupling scheme also includes large tantalum or electrolytic capacitors on the power supply connector to reduce low frequency ripple to insignificant levels.

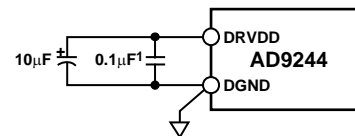

¹LOCATE AS CLOSE AS POSSIBLE TO SUPPLY PINS. 02404-062

Figure 62. Digital Supply Decoupling

Reference Decoupling

The VREF pin should be bypassed to the REFGND pin with a 10 μF tantalum capacitor in parallel with a low inductance 0.1 μF ceramic capacitor. It is also necessary to add a capacitor network to decouple the REFT and REFB pins. Figure 49 shows the recommended decoupling networks.

CML

The AD9244 has a midsupply reference point. This is used within the internal architecture of the AD9244 and must be decoupled with a 0.1 μF capacitor. It sources or sinks a load of up to 300 μA . If more current is required, the CML pin should be buffered with an amplifier.

VR

VR is an internal bias point on the AD9244. It must be decoupled to AGND with a 0.1 μF capacitor.

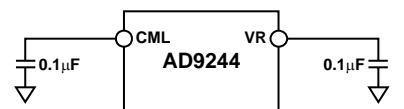

Figure 63. CML/VR Decoupling

EVALUATION BOARD

ANALOG INPUT CONFIGURATION

Table 12 provides a summary of the analog input configuration. The analog inputs of the AD9244 on the evaluation board can be driven differentially through a transformer via Connector S4, or through the AD8138 amplifier via Connector S2, or they can be driven single-ended directly via Connector S3. When using the transformer or AD8138 amplifier, a single-ended source can be used, as both of these devices are configured on the AD9244 evaluation board to convert single-ended signals to differential signals.

Optimal AD9244 performance is achieved above 500 kHz by using the input transformer. To drive the AD9244 via the transformer, connect solderable Jumper JP45 and Jumper JP46. DC bias is provided by Resistor R8 and Resistor R28. The evaluation board has positions for through-hole and surface-mount transformers.

For applications requiring lower frequencies or dc applications, the AD8138 can be used. The AD8138 provides good distortion and noise performance, as well as input buffering up to 30 MHz. For more information, refer to the AD8138 data sheet. To use the AD8138 to drive the AD9244, remove the transformer (T1 or T4) and connect solderable Jumper JP42 and Jumper JP43.

The AD9244 can be driven single-ended directly via S3 and can be ac-coupled or dc-coupled by removing or inserting JP5. To run the evaluation board in this way, remove the transformer (T1 or T4) and connect solderable Jumper JP40 and Jumper JP41. Resistor R40, Resistor R41, Resistor R8, and Resistor R28 are used to bias the AD9244 inputs to the correct common-mode levels in this application.

Table 12. Analog Input Jumper Configuration

Analog Input	Input Connector	Jumpers	Notes
Differential: Transformer	S4	45, 46	R8, R28 provide dc bias; optimal for 500 kHz.
Differential: Amplifier	S2	42, 43	Remove T1 or T4; used for low input frequencies.
Single-Ended	S3	5, 40, 41	Remove T1 or T4. JP5: connected for dc-coupled, not connected for ac-coupling.

Table 13. Reference Jumper Configuration

Reference	Voltage	Jumpers	Notes
Internal	2 V	23	JP8 not connected
Internal	1 V	24	JP8 not connected
Internal	$1\text{ V} \leq V_{\text{REF}} \leq 2\text{ V}$	25	JP8 not connected; $V_{\text{REF}} = 1 + R1/R2$
External	$1\text{ V} \leq V_{\text{REF}} \leq 2\text{ V}$	8, 22	Set VREF with R26

REFERENCE CONFIGURATION

As described in the Analog Input and Reference Overview section, the AD9244 can be configured to use its own internal or an external reference. An external reference, D3, and reference buffer, U5, are included on the AD9244 evaluation board. Jumper JP8 and Jumper JP22 to Jumper JP24 can be used to select the desired reference configuration (see Table 13).

CLOCK CONFIGURATION

The AD9244 evaluation board was designed to achieve optimal performance as well as to be easily configurable by the user. To configure the clock input, begin by connecting the correct combination of solderable jumpers (see Table 14). The specific jumper configuration is dependent on the application and can be determined by referring to the Clock Input Modes section. If the differential clock input mode is selected, an external sine wave generator applied to S5 can be used as the clock source. The clock buffer/drive MC10EL16 from ON Semiconductor® is used on the evaluation board to buffer and square the clock input. If the single-ended clock configuration is used, an external clock source can be applied to S1.

The AD9244 evaluation board generates a buffered clock at TTL/CMOS levels for use with a data capture system, such as the HSC-ADC-EVAL-SC system. The clock buffering is provided by U4 and U7 and is configured by Jumper JP3, Jumper JP4, Jumper JP9, and Jumper JP18 (see Table 14).

Table 14. Clock Jumper Configuration

Clock Input	Input Connector	Jumpers
DUT CLOCK		
Differential	S5	11, 13
Single-Ended	S1	12, 15
AD9226-Compatible	S1	12, 14
DATA CAPTURE CLOCK		
Internal		
Differential DUT Clock	N/A	9, 18A
Single-Ended DUT Clock	N/A	9, 18B
External	S6	3 or 4

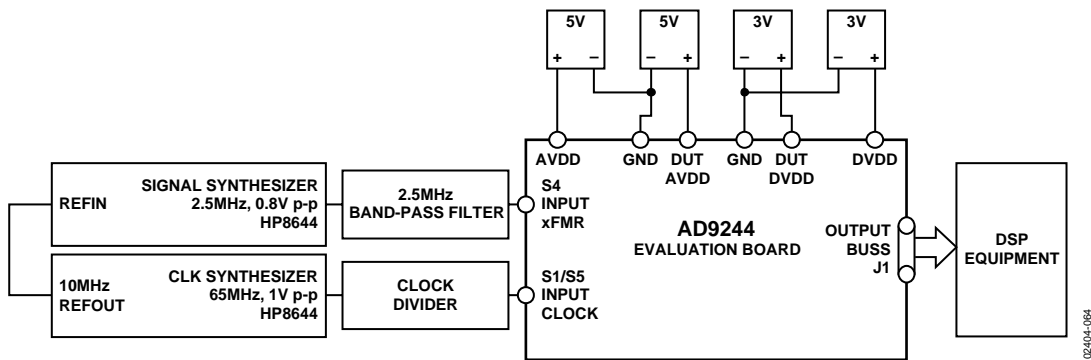
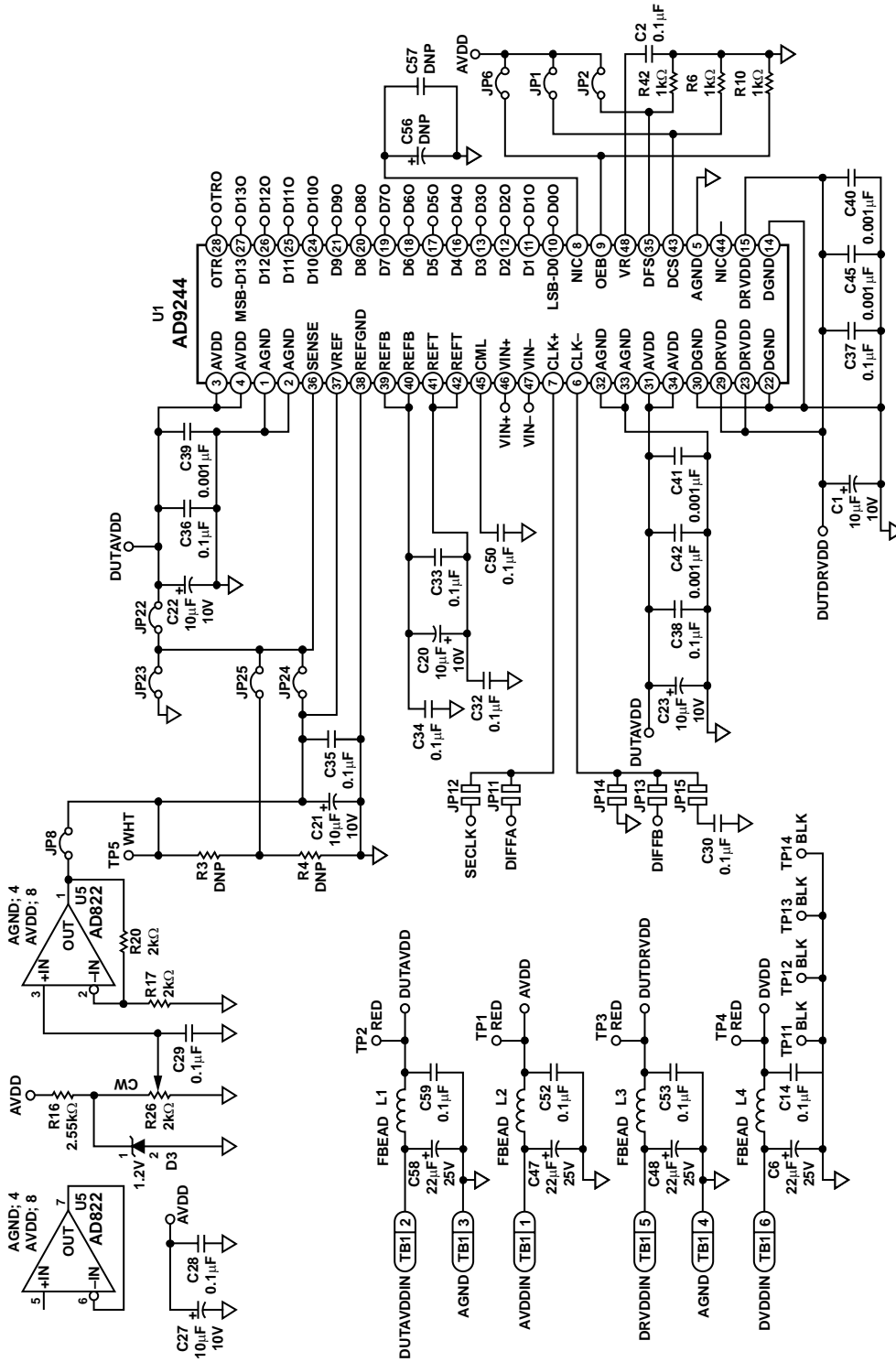

Figure 64. Evaluation Board Connections



02404-065

Figure 65. AD9244 Evaluation Board, ADC, External Reference, and Power Supply Circuitry

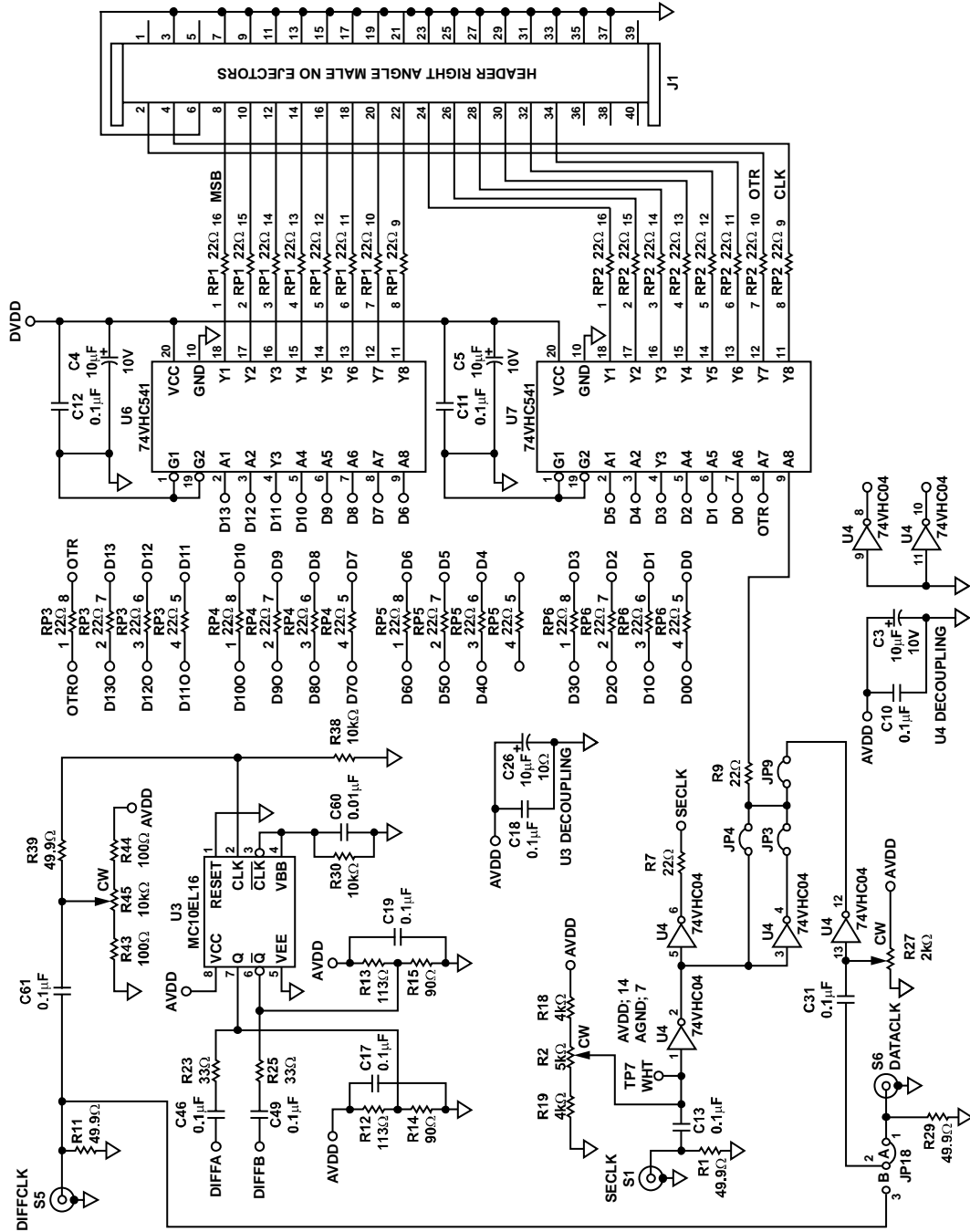

Figure 66. AD9244 Evaluation Board, Clock Input, and Digital Output Buffer Circuitry

02404-066

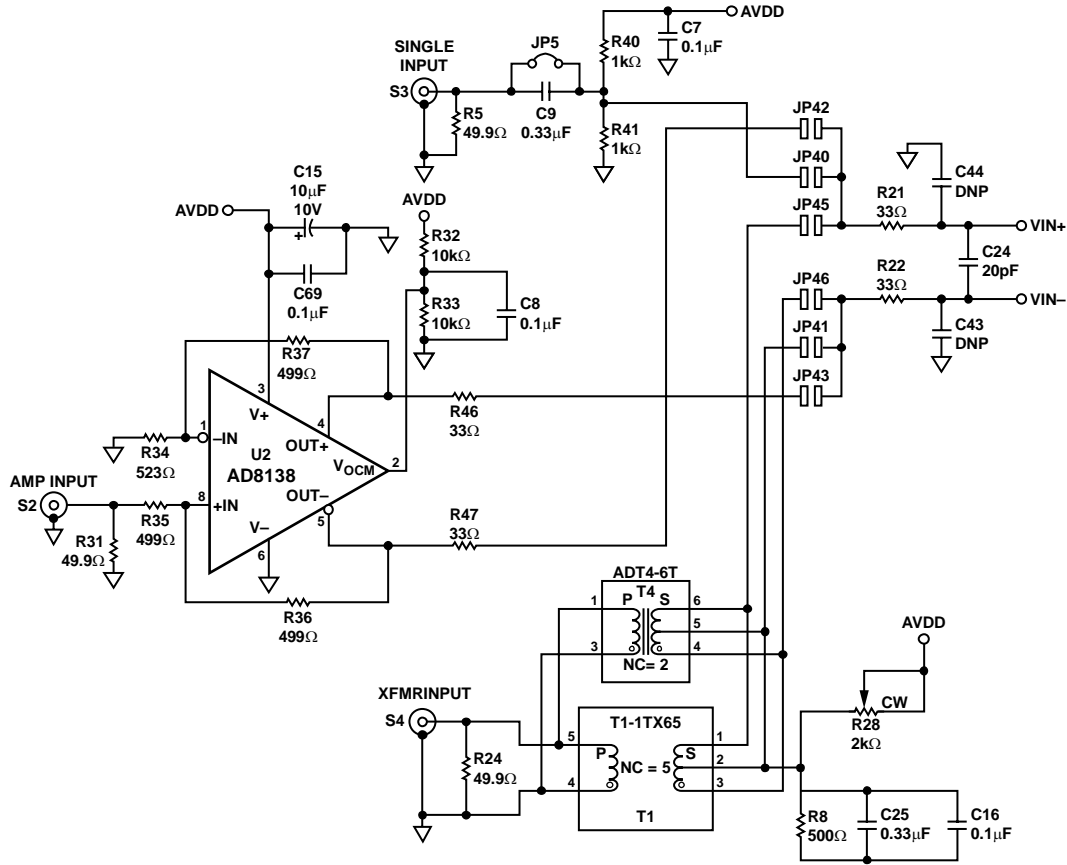

Figure 67. AD9244 Evaluation Board, Analog Input Circuitry

02404-067

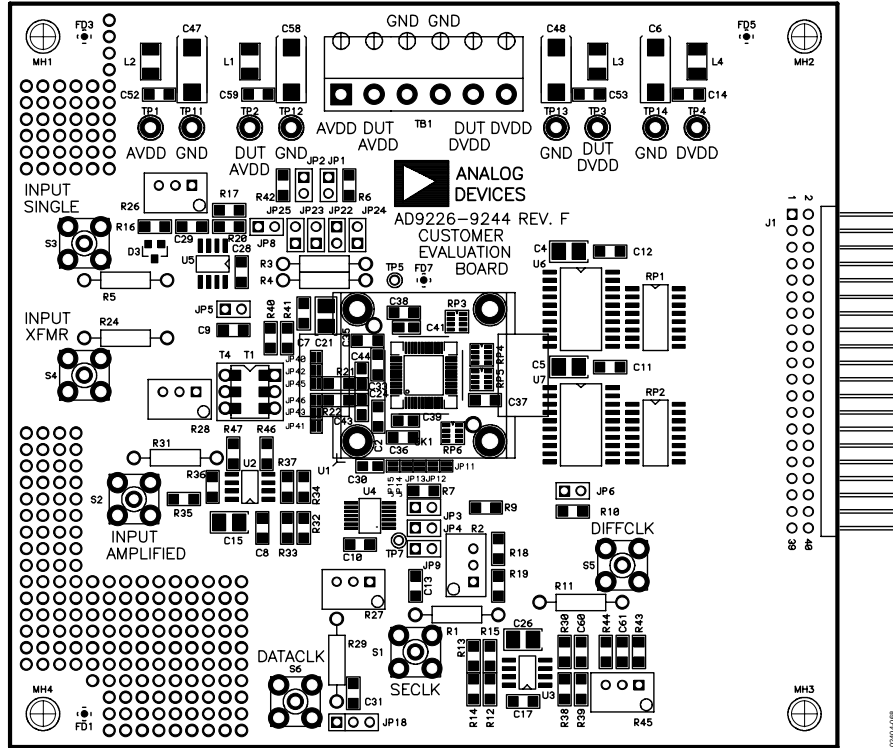

Figure 68. AD9244 Evaluation Board, PCB Assembly, Top

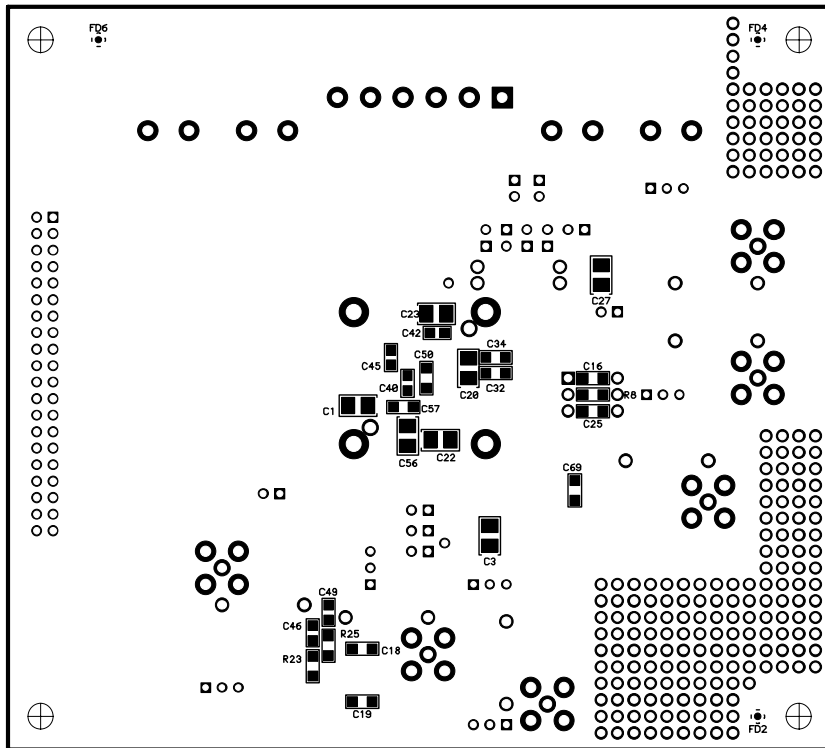

Figure 69. AD9244 Evaluation Board, PCB Assembly, Bottom

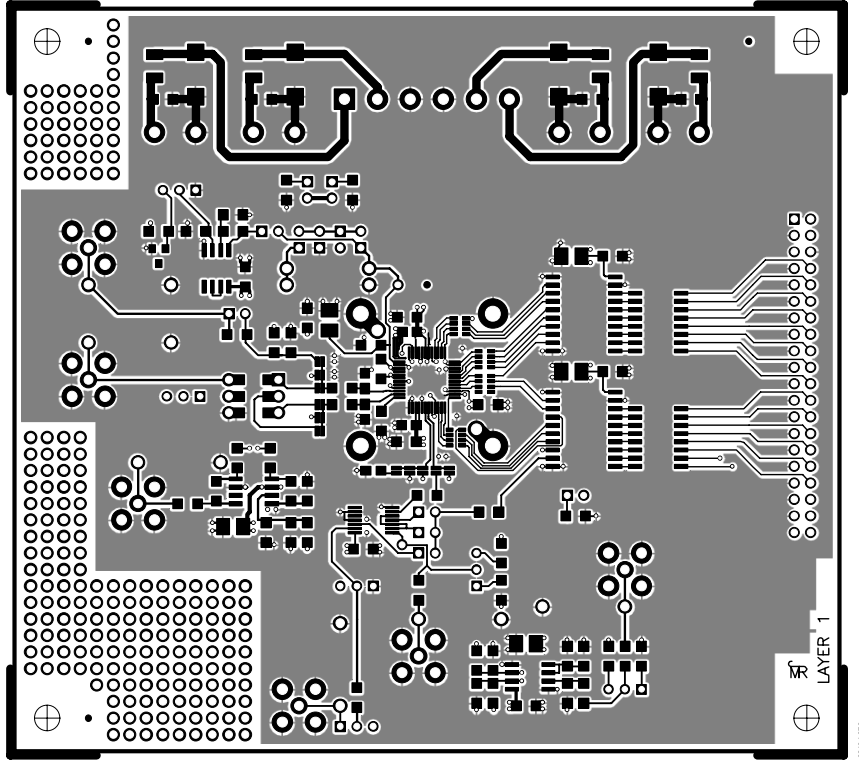

Figure 70. AD9244 Evaluation Board, PCB Layer 1 (Top)

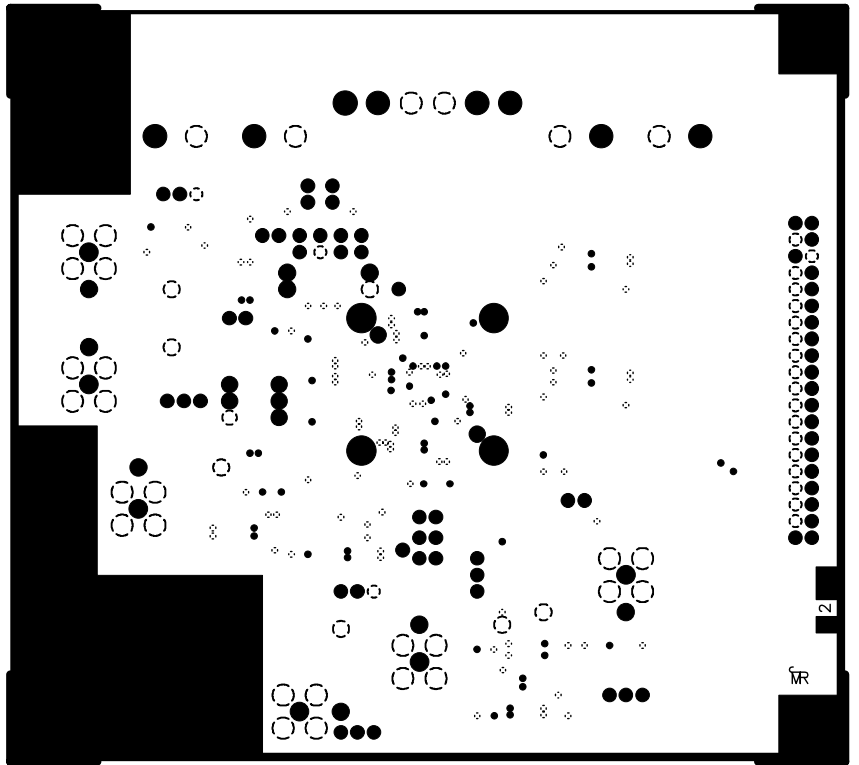

Figure 71. AD9244 Evaluation Board, PCB Layer 2 (Ground Plane)

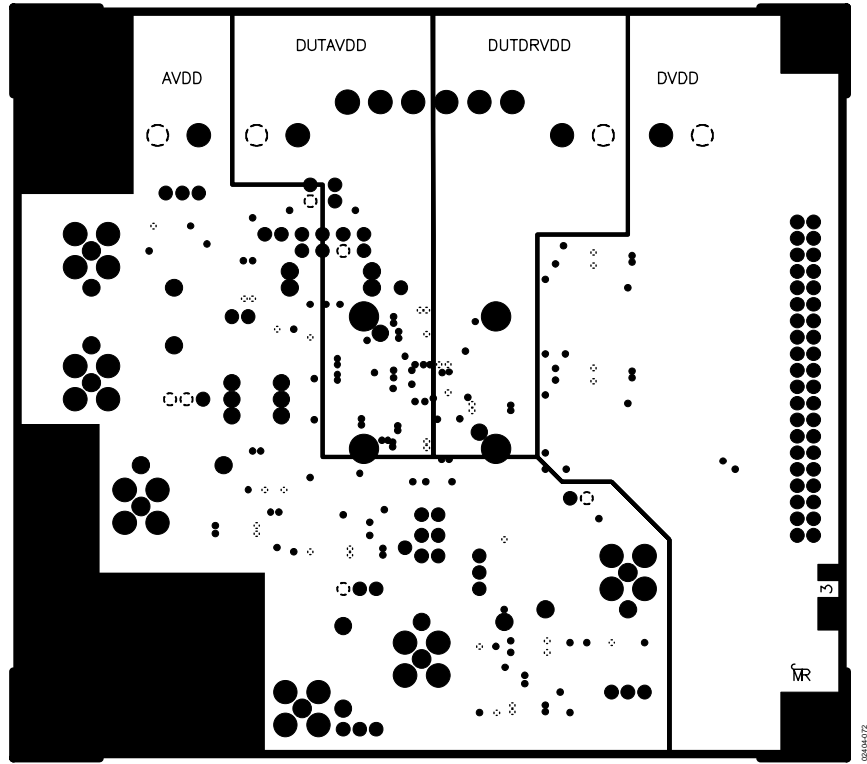

Figure 72. AD9244 Evaluation Board, PCB Layer 3 (Power Plane)

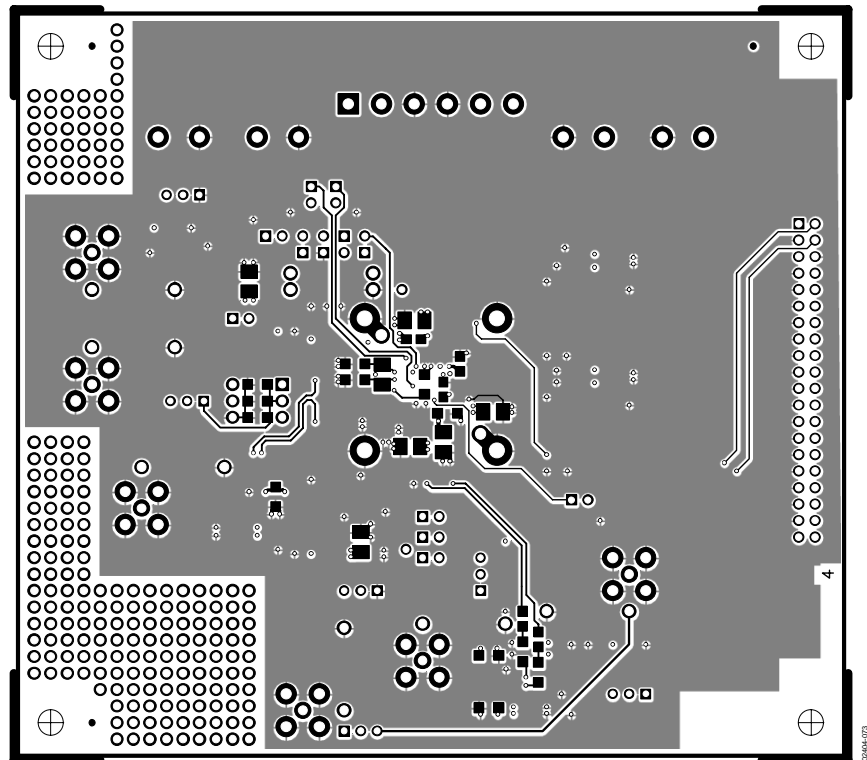

Figure 73. AD9244 Evaluation Board, PCB Layer 4 (Bottom)

AD9244

Table 15. Evaluation Board Bill of Materials

Item	Qty.	Reference Designator	Description	Package	Value
1	11	C1, C3, C4, C5, C15, C20, C21, C22, C23, C26, C27	Tantalum capacitors	BCASE	10 μ F
2	28	C2, C7, C8, C10, C11, C12, C13, C14, C16, C17, C18, C19, C28, C29, C31, C32, C33, C34, C35, C36, C37, C38, C50, C52, C53, C59, C61, C69	Chip capacitors	1206	0.1 μ F
3	4	C6, C47, C48, C58	Tantalum capacitors	DCASE	22 μ F
4	2	C9, C25	Chip capacitors	1206	0.33 μ F
5	1	C24	Chip capacitor	0805	20 pF
6	3	C30, C46, C49	Chip capacitors	0805	0.1 μ F
7	5	C39, C40, C41, C42, C45	Chip capacitors	0805	0.001 μ F
8	2	C43, C44	DNP ¹	0805	DNP ¹
9	1	C60	Chip capacitor	1206	0.01 μ F
10	1	D3	Diode	SOT-23 Can	1.2 V
11	1	J1	Header male	40 PIN RA	Header
12	12	JP1, JP2, JP3, JP4, JP5, JP6, JP8, JP9, JP22, JP23, JP24, JP25	Headers	JPRBLK02	
13	11	JP11, JP12, JP13, JP14, JP15, JP40, JP41, JP42, JP43, JP45, JP46	Solder jumpers		
14	1	JP18	Header	JPRBLK03	
15	4	L1, L2, L3, L4	Chip inductors	LC1210	FBEAD
16	6	R1, R5, R11, R24, R29, R31	Chip resistors	RC07CUP	49.9 Ω
17	1	R2	Potentiometer	RV3299UP	5 k Ω
18	2	R3, R4	DNP ¹	RC07CUP	DNP ¹
19	5	R6, R10, R40, R41, R42	Chip resistors	1206	1 k Ω
20	2	R7, R9	Chip resistors	1206	22 Ω
21	1	R8	Chip resistor	1206	500 Ω
22	2	R12, R13	Chip resistors	1206	113 Ω
23	2	R14, R15	Chip resistors	1206	90 Ω
24	1	R16	Chip resistor	1206	2.55 k Ω
25	2	R17, R20	Chip resistors	1206	2 k Ω
26	2	R18, R19	Chip resistors	1206	4 k Ω
27	6	R21, R22, R23, R25, R46, R47	Chip resistors	1206	33 Ω
28	3	R26, R27, R28	Potentiometers	RV3299UP	2 k Ω
29	4	R30, R32, R33, R38	Chip resistors	1206	10 k Ω
30	1	R34	Chip resistor	1206	523 Ω
31	3	R35, R36, R37	Chip resistors	1206	499 Ω
32	1	R39	Chip resistor	1206	49.9 Ω
33	2	R43, R44	Chip resistors	1206	100 Ω
34	1	R45	Potentiometer	RV3299UP	10 k Ω
35	2	RP1, RP2	Resistor packs	RCTS766	22 Ω
36	4	RP3, RP4, RP5, RP6	Resistor packs	RCA74204	22 Ω
37	6	S1, S2, S3, S4, S5, S6	SMA connectors 50 Ω	SMA200UP	
38	1	T1	Transformer	DIP06RCUP	T1-1TX65
39	1	T4	Transformer	MINI_CD637	ADT4-6T
40	1	TB1	Header	TBLK06REM	
40a	1	TB1a	Header		
41	4	TP1, TP2, TP3, TP4	Test points	LOOPTP	RED
42	2	TP5, TP7	Test points	LOOPMINI	WHT
43	4	TP11, TP12, TP13, TP14	Test points	LOOPTP	BLK
44	1	U1	AD9244	LQFP-48	AD9244
45	1	U2	AD8138 amplifier	R-8	AD8138
46	1	U3	ECL divider	SO8	MC10EL16
47	1	U4	Hex inverter	TSSOP14	74VHC04MTC
48	1	U5	AD822 op amp	SOIC-8	AD822
49	2	U6, U7	Octal registers	SOL20	74VHC541

Item	Qty.	Reference Designator	Description	Package	Value
50	14	Sockets for through resistors	Solder sockets		
51	2	C56, C57			DNP ¹
Total	183				

¹ Do not place.

OUTLINE DIMENSIONS

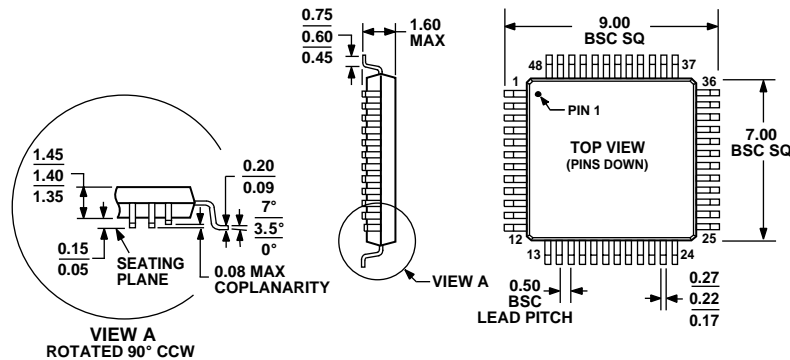

COMPLIANT TO JEDEC STANDARDS MS-026-BBC

Figure 74. 48-Lead Low Profile Quad Flat Package [LQFP] (ST-48)

Dimensions shown in millimeters

ORDERING GUIDE

Model	Temperature Range	Package Description	Package Option
AD9244BST-65	-40°C to +85°C	48-Lead Low Profile Quad Flat Package (LQFP)	ST-48
AD9244BSTRL-65	-40°C to +85°C	48-Lead Low Profile Quad Flat Package (LQFP)	ST-48
AD9244BSTZ-65 ¹	-40°C to +85°C	48-Lead Low Profile Quad Flat Package (LQFP)	ST-48
AD9244BSTZRL-65 ¹	-40°C to +85°C	48-Lead Low Profile Quad Flat Package (LQFP)	ST-48
AD9244BST-40	-40°C to +85°C	48-Lead Low Profile Quad Flat Package (LQFP)	ST-48
AD9244BSTRL-40	-40°C to +85°C	48-Lead Low Profile Quad Flat Package (LQFP)	ST-48
AD9244BSTZ-40 ¹	-40°C to +85°C	48-Lead Low Profile Quad Flat Package (LQFP)	ST-48
AD9244BSTZRL-40 ¹	-40°C to +85°C	48-Lead Low Profile Quad Flat Package (LQFP)	ST-48
AD9244-65PCB		Evaluation Board	
AD9244-40PCB		Evaluation Board	

¹ Z = Pb-free part.

Mouser Electronics

Authorized Distributor

Click to View Pricing, Inventory, Delivery & Lifecycle Information:

[Analog Devices Inc.:](#)

[AD9244BSTZRL-65](#) [AD9244BSTZ-40](#) [AD9244BSTZ-65](#) [AD9244BSTZRL-40](#)