

# Medium Power Film Capacitors



## FPX (FPY RoHS Compliant)

### PROTECTION



### DIMENSIONS

#### Plastic Case Style M6 / 6 or M8 / 8

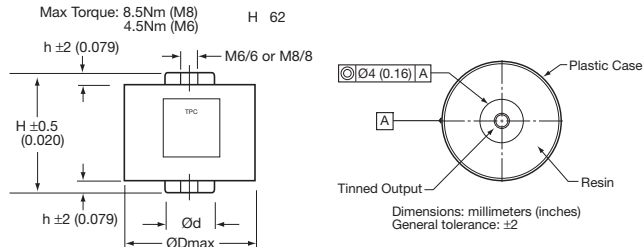

#### Plastic Case Style M8 / 10

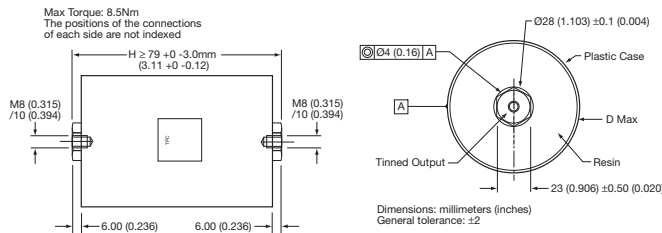

### MARKING

Logo

Withstanding surge voltage

Capacitance and tolerance in clear

Nominal DC voltage in clear

RMS current in clear

Date of manufacture (IEC coding)

### HOW TO ORDER

FPX	6	6	N	0105	J	--
<b>Series</b> FPX = Standard FPY = RoHS Compliant	<b>Case Size</b> Case Size 6 Case Size 8 (See Case Style)	<b>Dielectric</b> 6 = Polypropylene	<b>Voltage Code</b> N = 2000V P = 2500V X = 3500V Z = 4500V Y = 4600V	<b>Capacitance Code</b> 0 + pF code 0105 = 1.0µF 0335 = 3.5µF 0504 = 0.5µF etc.	<b>Capacitance Tolerances</b> J = ±5%	<b>Terminal Code</b> -- = Standard

Not RoHS Compliant



### APPLICATIONS

Protection of thyristors.

Protection of gate turn-off thyristor (G.T.O.).

Clamping (Secondary snubber).

### TECHNOLOGY

Metallized polypropylene dielectric capacitor with controlled self-healing.

Reinforced metallization developed for high impulse currents.

Axial connections specially developed to reduce series inductance and to provide rigid mechanical mounting.

### PACKAGING MATERIAL

Cylindrical in plastic case filled with thermosetting resin.

Outputs: threaded inserts either M6 or M8.

### HOT SPOT TEMPERATURE CALCULATION

See *Hot Spot Temperature* page 3.

$$\theta_{\text{hot spot}} = \theta_{\text{terminals}} + (P_d + P_t) \times R_{th}$$

with

$$P_d \text{ (Dielectric losses)} = Q \times \text{tg}\delta_0$$

$$\Rightarrow [ \frac{1}{2} \times C_n \times (V_{\text{peak to peak}})^2 \times f ] \times (2 \times 10^{-4})$$

$$P_t \text{ (Thermal losses)} = R_s \times (I_{\text{rms}})^2$$

where

$C_n$  in Farads

$V$  in Volts

$I_{\text{rms}}$  in Amperes

$R_s$  in Ohms

$f$  in Hertz

$\theta$  in °C

$R_{th}$  in °C/W

Due to the design of the capacitor and its technology, the thermal impedance between the terminations and the core of the capacitor is low, it is necessary to take care that the capacitor is never overheated by use of incorrect sized connections.

In the case where the series diodes are screwed to the capacitor, cooling of the diodes must be taken in account.

Do not use the capacitor as a heat sink.

Due to the complexity of the diode/capacitor thermal exchanges, we recommend that thermal measurements shall be made on the different components. We would be pleased to advise you on specific problems.

### WORKING TEMPERATURE

(according to the power to be dissipated) -40°C to +85°C



# Medium Power Film Capacitors



## FPX (FPY RoHS Compliant)

### ELECTRICAL CHARACTERISTICS

Capacitance range $C_n$	0.5 $\mu$ F to 6 $\mu$ F
Tolerance on $C_n$	$\pm 5\%$
Rated DC voltage $V_{n,dc}$	1000 to 3000 V
Peak voltage $V_{peak}$	1600 to 4000 V
Allowable overvoltage $V_s$ (for 10 s/day)	2000 to 4600 V
Stray inductance	5 to 20 nH
RMS current	$I_{rms}$ max. = up to 160 A The currents shown in the tables are maximum. It is necessary to respect the thermal limits of the dielectric 85°C see "Hot spot temperature calculation"
Insulation resistance	$R_i \times C \geq 30,000$ s
Impulse current	$I^2.t$ maxi. = up to 729 A <sup>2</sup> .s Spikes or peak currents in the capacitors may cause a deterioration of the bonding between the metallization and the connections. These bonds are capable of withstanding only a limited amount of energy for each spike. The table shows the maximum energy permitted in the form ( $I^2.t$ ), where I is in Ampere, and t is in seconds.
<b>Note:</b> The formula ( $I^2.t$ ) replaces $dV/dt$ which is less easy to use as it is not an expression of energy ( $I = C.dV/dt$ ). This type of capacitor has been designed to withstand high ( $I^2.t$ ) values.	
Variation of capacitance with temperature	$\frac{\Delta C}{C} \leq \pm 2\%$ between -40 and 85°C
Climatic category	40/085/56 (IEC 60068)
Test voltage between terminals @ 25°C	$V_s$ for 10s
Test voltage between terminals and case @ 25°C (Type test)	@ 7 kVrms @ 50 Hz for 1 min.
Dielectric	Polypropylene

# Medium Power Film Capacitors



## FPX (FPY RoHS Compliant) Table of Values

### PROTECTION

Dimensions: millimeters (inches)

Part Number	Cn (µF)	Case Style	Dimensions				I <sup>2</sup> t max. (A <sup>2</sup> .s)	I <sub>rms</sub> max. (A)	R <sub>s</sub> (mΩ)	R <sub>th</sub> (°C/W)	Typical Weight (g)
			H* ±0.5 (±0.020)	h ±2 (±0.079)	D max.	d ±0.5 (±0.020)					
<b>FPX 2000V V<sub>n</sub>dc = 1000V V<sub>peak</sub> = 1600V V<sub>rms</sub> = 560V V<sub>s</sub> = 2000V (Voltage Code N)</b>											
FPX66N0105J--	1	Plastic case M6/6	52 (2.072)	5 (0.197)	40 (1.575)	18 (0.709)	2	15	2.4	14	120
FPX86N0205J--	2	Plastic case M8/8	52 (2.072)	5 (0.197)	60 (2.362)	22 (0.866)	8	30	1.2	6.1	190
FPX86N0305J--	3	Plastic case M8/8	52 (2.072)	5 (0.197)	72 (2.835)	22 (0.866)	18	45	0.9	4.5	260
FPX86N0355J--	3.5	Plastic case M8/8	52 (2.072)	5 (0.197)	72 (2.835)	22 (0.866)	25	50	0.85	4.5	260
FPX86N0405J--	4	Plastic case M8/8	52 (2.072)	5 (0.197)	82 (3.228)	22 (0.866)	32	60	0.75	3.5	320
FPX86N0505J--	5	Plastic case M8/8	52 (2.072)	5 (0.197)	82 (3.228)	22 (0.866)	50	70	0.65	2.5	320
<b>FPX 2500V V<sub>n</sub>dc = 1300V V<sub>peak</sub> = 2000V V<sub>rms</sub> = 700V V<sub>s</sub> = 2500V (Voltage Code P)</b>											
FPX66P0504J--	0.5	Plastic case M6/6	52 (2.072)	5 (0.197)	40 (1.575)	18 (0.709)	1	15	3	14	120
FPX86P0105J--	1	Plastic case M8/8	52 (2.072)	5 (0.197)	60 (2.362)	22 (0.866)	3	20	2.3	10.5	190
FPX86P0155J--	1.5	Plastic case M8/8	52 (2.072)	5 (0.197)	60 (2.362)	22 (0.866)	7	30	1.5	6.1	190
FPX86P0205J--	2	Plastic case M8/8	52 (2.072)	5 (0.197)	72 (2.835)	22 (0.866)	12.7	40	1.1	4.5	260
FPX86P0255J--	2.5	Plastic case M8/8	52 (2.072)	5 (0.197)	72 (2.835)	22 (0.866)	20	60	0.89	3.7	260
FPX86P0305J--	3	Plastic case M8/8	52 (2.072)	5 (0.197)	82 (3.228)	22 (0.866)	28	60	0.85	3.2	320
FPX86P0355J--	3.5	Plastic case M8/8	52 (2.072)	5 (0.197)	82 (3.228)	22 (0.866)	39	65	0.78	2.9	320
<b>FPX 3500V V<sub>n</sub>dc = 2000V V<sub>peak</sub> = 2400V V<sub>rms</sub> = 850V V<sub>s</sub> = 3500V (Voltage Code X)</b>											
FPX86X0205J--	2	Plastic case M8/8	62 (2.441)	5 (0.197)	72 (2.835)	22 (0.866)	23	41	1.24	6.1	310
FPX86X0305J--	3	Plastic case M8/8	62 (2.441)	5 (0.197)	92 (3.622)	22 (0.866)	50	62	0.92	3.9	475
FPX86X0355J--	3.5	Plastic case M8/8	62 (2.441)	5 (0.197)	92 (3.622)	22 (0.866)	70	72	0.83	3.4	475
FPX86X0405J--	4	Plastic case M8/8	62 (2.441)	5 (0.197)	92 (3.622)	22 (0.866)	85	80	0.78	3.1	475
<b>FPX 4500V V<sub>n</sub>dc = 2500V V<sub>peak</sub> = 3200V V<sub>rms</sub> = 1130V V<sub>s</sub> = 4500V (Voltage Code Z)</b>											
FPX86Z0904J--	0.9	Plastic case M8/8	62 (2.441)	5 (0.197)	72 (2.835)	22 (0.866)	15	40	1.5	6.2	310
FPX86Z0105J--	1	Plastic case M8/8	62 (2.441)	5 (0.197)	72 (2.835)	22 (0.866)	15	38	1.4	6.2	310
FPX86Z0205J--	2	Plastic case M8/8	62 (2.441)	5 (0.197)	92 (3.622)	22 (0.866)	70	75	0.85	3.1	475
<b>FPX 4600V V<sub>n</sub>dc = 3000V V<sub>peak</sub> = 4000V V<sub>rms</sub> = 1400V V<sub>s</sub> = 4600V (Voltage Code Y)</b>											
FPX86Y0504J--	0.5	Plastic case M8/8	62 (2.441)	5 (0.197)	72 (2.835)	22 (0.866)	7	40	1.7	12	310
FPX86Y0684J--	0.68	Plastic case M8/8	62 (2.441)	5 (0.197)	72 (2.835)	22 (0.866)	14	35	1.59	6.2	310
FPX86Y1254J--	1.25	Plastic case M8/8	62 (2.441)	5 (0.197)	92 (3.622)	22 (0.866)	50	65	1	3.3	475
FPX86Y0155J--	1.5	Plastic case M8/10	79 (3.110)	6 (0.236)	98 (3.858)	–	32	60	1.4	8.3	630
FPX86Y0175J--	1.7	Plastic case M8/10	79 (3.110)	6 (0.236)	98 (3.858)	–	40	70	1.3	7.4	630
FPX86Y0205J--	2	Plastic case M8/10	79 (3.110)	6 (0.236)	98 (3.858)	–	56	80	1.1	6.3	630
FPX86Y0255J--	2.5	Plastic case M8/10	118 (4.646)	6 (0.236)	98 (3.858)	–	200	130	0.8	1.1	1020
FPX86Y0275J--	2.7	Plastic case M8/10	118 (4.646)	6 (0.236)	98 (3.858)	–	232	140	0.7	1.1	1020
FPX86Y0305J--	3	Plastic case M8/10	143 (5.630)	6 (0.236)	98 (3.858)	–	128	100	0.9	1.5	1280
FPX86Y0355J--	3.5	Plastic case M8/10	143 (5.630)	6 (0.236)	98 (3.858)	–	170	110	0.8	1.4	1280
FPX86Y0405J--	4	Plastic case M8/10	143 (5.630)	6 (0.236)	98 (3.858)	–	224	115	0.8	1.4	1280
FPX86Y0455J--	4.5	Plastic case M8/10	163 (6.417)	6 (0.236)	98 (3.858)	–	522	120	0.6	1.7	1500
FPX86Y0505J--	5	Plastic case M8/10	163 (6.417)	6 (0.236)	98 (3.858)	–	600	130	0.6	1.7	1500
FPX86Y0605J--	6	Plastic case M8/10	163 (6.417)	6 (0.236)	98 (3.858)	–	729	160	0.5	1.7	1500

\* Tol: +0 / -3mm for H ≥ 118mm

PROTECTION



# Medium Power Film Capacitors



## FPX (FPY RoHS Compliant) General / Application Notes

### PROTECTION

#### G.T.O.

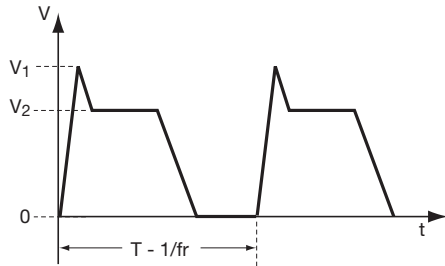

Choice of voltage:  $V_1 \leq V_{peak}$   
 $V_2 \leq V_{ndc}$

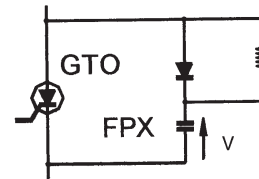

Nominal DC voltage ( $V_{ndc}$ ) and peak voltage ( $V_{peak}$ ) are given in the tables.

#### THYRISTOR

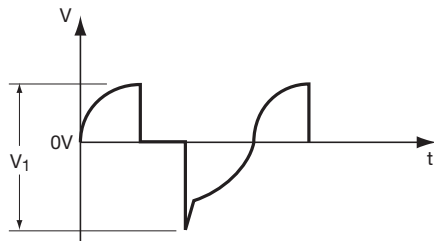

Choice of voltage:  $V_1 \leq V_{peak}$

Note that  $V_1$  is the voltage peak to peak and cannot be symmetrical vs 0 V

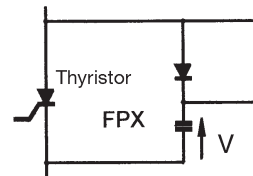

Peak voltage is given in the tables.

#### CLAMPING

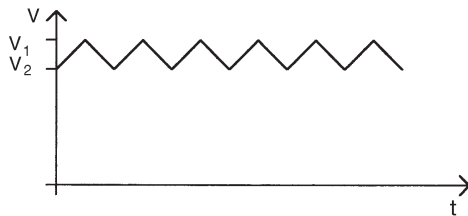

Choice of voltage:  $V_1 \leq V_{peak}$   
 $V_2 \leq V_{ndc}$

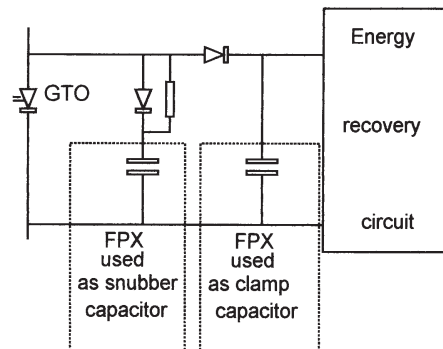

Nominal DC voltage ( $V_{ndc}$ ) and peak voltage ( $V_{peak}$ ) are given in the tables.

PROTECTION

# Mouser Electronics

Authorized Distributor

Click to View Pricing, Inventory, Delivery & Lifecycle Information:

[AVX:](#)

[FPX66-9179--B](#) [FPX86P0305J](#) [FPX86P0305J--](#) [FPX86P0105J--](#) [FPX86-9448--A](#) [FPY86-9448--B](#) [FPX86P0155J--](#)  
[FPX66P0504J--](#) [FPX86P0205J--](#) [FPX86Y0405J--](#) [FPX66N0105J--](#)