

Base strip - MSTBVA 2,5 HC/ 6-G-5,08 - 1924347

Please be informed that the data shown in this PDF Document is generated from our Online Catalog. Please find the complete data in the user's documentation. Our General Terms of Use for Downloads are valid (<http://phoenixcontact.com/download>)

Header, Nominal current: 16 A, Rated voltage (III/2): 320 V, Number of positions: 6, Pitch: 5.08 mm, Color: green, Contact surface: Tin, Mounting: Wave soldering



The figure shows a 10-position version of the product

Product Features

- 16 A (HC) headers in horizontal and vertical (MSTBV) versions
- Lateral HC marking („High Current“)
- Coding sections (CR) as protection against mismatching
- Vibration-resistant connection by means of threaded flange (-GF)
- Lateral mismatching prevented by side panels

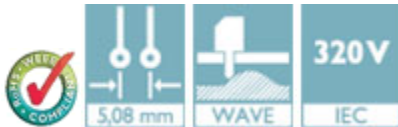

Key Commercial Data

Packing unit	1 pc
Minimum order quantity	50 pc
Weight per Piece (excluding packing)	2.4 g
Custom tariff number	85366990
Country of origin	Germany

Technical data

Dimensions

Length	8.6 mm
Pitch	5.08 mm
Dimension a	25.4 mm
Constructional height	12 mm
Length of the solder pin	3.9 mm
Pin dimensions	1 x 1 mm

Base strip - MSTBVA 2,5 HC/ 6-G-5,08 - 1924347

Technical data

Dimensions

Pin spacing	5.00 mm
Hole diameter	1.4 mm

General

Range of articles	MSTBVA 2,5 HC/..-G
Insulating material group	I
Rated surge voltage (III/3)	4 kV
Rated surge voltage (III/2)	4 kV
Rated surge voltage (II/2)	4 kV
Rated voltage (III/3)	250 V
Rated voltage (III/2)	320 V
Rated voltage (II/2)	400 V
Connection in acc. with standard	EN-VDE
Nominal current I _N	16 A (see derating curve)
Maximum load current	16 A
Insulating material	PA
Flammability rating according to UL 94	V0
Color	green
Number of positions	6

Standards and Regulations

Connection in acc. with standard	EN-VDE
	CUL
Flammability rating according to UL 94	V0

Classifications

eCl@ss

eCl@ss 4.0	272607xx
eCl@ss 4.1	27260701
eCl@ss 5.0	27260701
eCl@ss 5.1	27260701
eCl@ss 6.0	27260704
eCl@ss 7.0	27440402
eCl@ss 8.0	27440402
eCl@ss 9.0	27440402

Base strip - MSTBVA 2,5 HC/ 6-G-5,08 - 1924347

Classifications

ETIM

ETIM 3.0	EC001121
ETIM 4.0	EC002637
ETIM 5.0	EC002637

UNSPSC

UNSPSC 6.01	30211810
UNSPSC 7.0901	39121409
UNSPSC 11	39121409
UNSPSC 12.01	39121409
UNSPSC 13.2	39121409

Approvals

Approvals

Approvals

VDE Gutachten mit Fertigungsüberwachung / IECEx CB Scheme / EAC / cULus Recognized / EAC

Ex Approvals

Approvals submitted

Approval details

VDE Gutachten mit Fertigungsüberwachung 	
Nominal current IN	16 A
Nominal voltage UN	250 V

IECEE CB Scheme 	
Nominal current IN	16 A

Base strip - MSTBVA 2,5 HC/ 6-G-5,08 - 1924347

Approvals

Nominal voltage UN	250 V
--------------------	-------

EAC

cULus Recognized		
	B	D
Nominal current IN	16 A	10 A
Nominal voltage UN	300 V	300 V

EAC

Accessories

Accessories

Coding element

Coding star - CR-MSTB - 1734401



Coding section, inserted into the recess in the header or the inverted plug, red insulating material

Filler plug

Accessories - MSTB-BL - 1755477



Keying cap, for forming sections, plugs onto header pin, green insulating material

Labeled terminal marker

Base strip - MSTBVA 2,5 HC/ 6-G-5,08 - 1924347

Accessories

Marker card - SK 5,08/3,8:FORTL.ZAHLEN - 0804293



Marker card, Card, white, labeled, Horizontal: Consecutive numbers 1 - 10, 11 - 20, etc. up to 91 - (99)100, Mounting type: Adhesive, for terminal block width: 5.08 mm, Lettering field: 5.08 x 3.8 mm

Additional products

Printed-circuit board connector - MSTB 2,5 HC/ 6-ST-5,08 - 1912003



Plug component, Nominal current: 16 A, Rated voltage (III/2): 320 V, Number of positions: 6, Pitch: 5.08 mm, Connection method: Screw connection with tension sleeve, Color: green, Contact surface: Tin

Printed-circuit board connector - MVSTBR 2,5 HC/ 6-ST-5,08 - 1912443



Plug component, Nominal current: 16 A, Rated voltage (III/2): 320 V, Number of positions: 6, Pitch: 5.08 mm, Connection method: Screw connection with tension sleeve, Color: green, Contact surface: Tin

Printed-circuit board connector - MVSTBW 2,5 HC/ 6-ST-5,08 - 1912883



Plug component, Nominal current: 16 A, Rated voltage (III/2): 320 V, Number of positions: 6, Pitch: 5.08 mm, Connection method: Screw connection with tension sleeve, Color: green, Contact surface: Tin

Printed-circuit board connector - FKC 2,5 HC/ 6-ST-5,08 - 1942413



Plug component, Nominal current: 16 A, Rated voltage (III/2): 320 V, Number of positions: 6, Pitch: 5.08 mm, Connection method: Push-in spring connection, Color: green, Contact surface: Tin

Base strip - MSTBVA 2,5 HC/ 6-G-5,08 - 1924347

Drawings

Drilling diagram

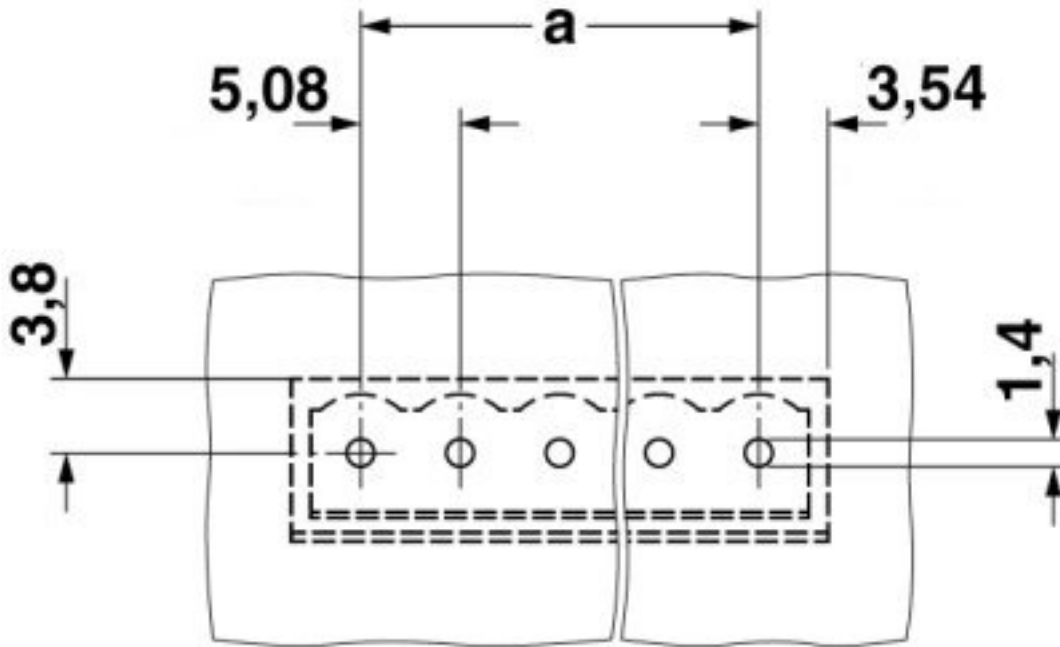

Dimensional drawing

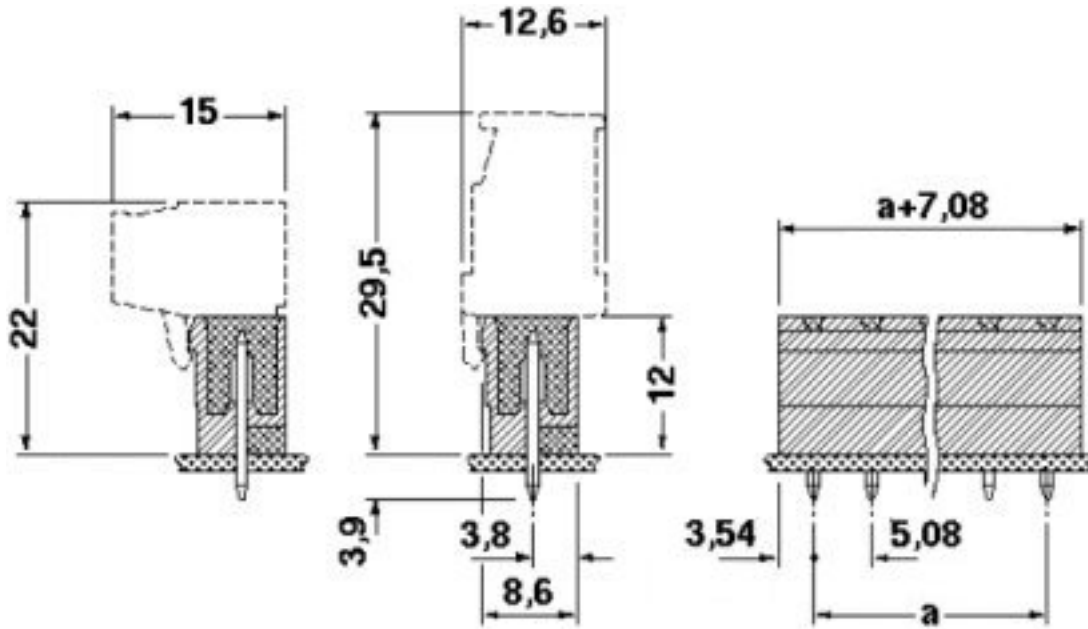

Mouser Electronics

Authorized Distributor

Click to View Pricing, Inventory, Delivery & Lifecycle Information:

[Phoenix Contact:](#)

[1924347](#)