

Copying of this document and giving it to others and the use or communication of the contents thereof, are forbidden without express authority. Offenders are liable to the payment of damages. All rights are reserved in the event of the grant of a patent or the registration of the utility model or design.

Weitergabe sowie Vervielfältigung dieser Unterlage, Verwertung und Mitteilung ihres Inhalts nicht gestattet, soweit nicht ausdrücklich zugestanden. Zuwiderhandlungen verpflichten zu Schadenersatz. Alle Rechte für den Fall der Patenterteilung oder Gebrauchsmuster-Eintragung vorbehalten.

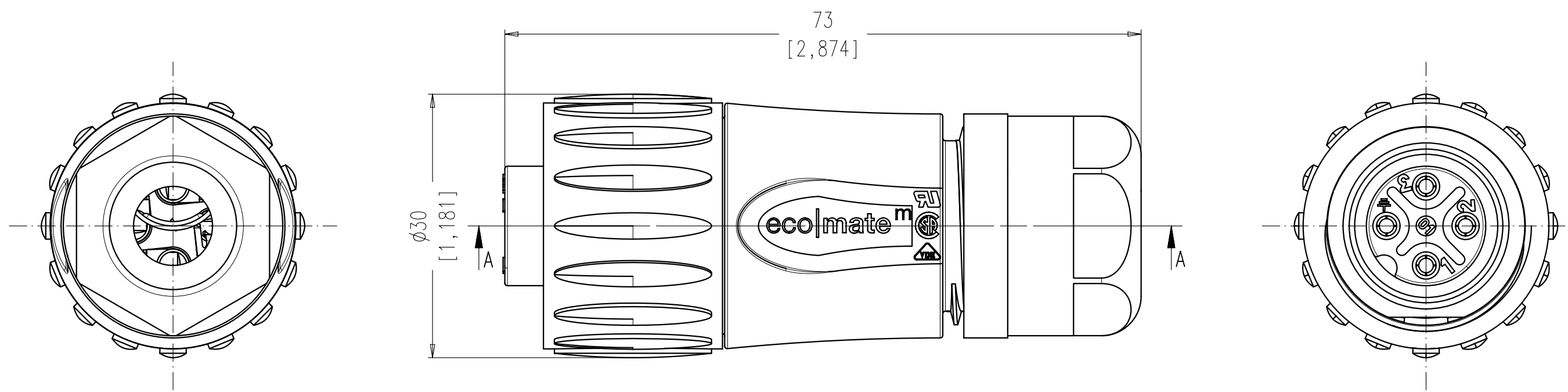

Schnitt A-A
section A-A

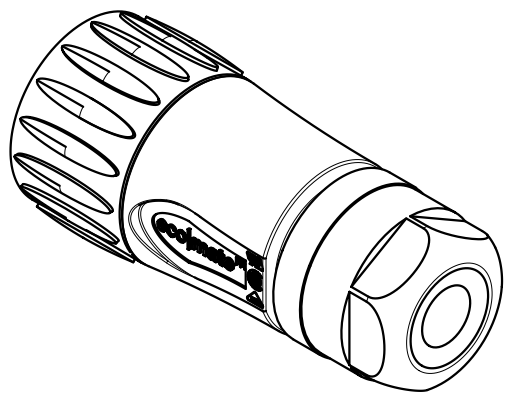
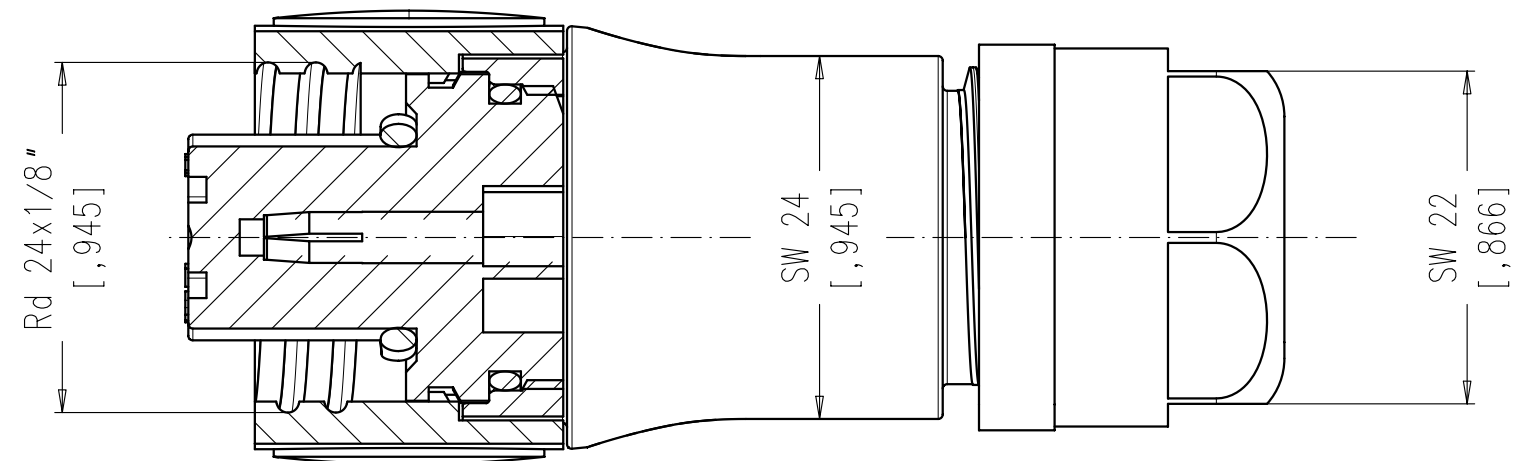

Polzahl / No. of contacts	3 + PE
Anschlußart / Termination	schrauben / screw
Anschlußquerschnitt / Wire gauge	0,75 mm ² - 2,5 mm ² AWG 18 - 14 ⁽⁰²⁾
Bemessungsspannung / Rated insulation voltage	400 V
Strombelastbarkeit / Current carrying capacity	16 A / +55°C 16 A / +131°F
Betriebstemperatur / Operating temperature	-40°C ... +100°C -40°F ... +212°F
Schutzart / Protection Class	IP 65 / IP 67
Verriegelung / Locking system	Schraubverriegelung / threaded coupling

Gewicht (errechnet) / Calc WT: 9		Zul. Abw. / Tolerances:		Maßstab / Scale 2:1; 1:1 A3	
Prüfmaß / Test dimension		DIN 6784		CUSTOMER DRAWING	
Teileindex Part index number		05	Datum / Date	Name	Kabeldose 3+PE, Schraubanschluss female cable connector, screw type
		Gez.	13.01.	Cionvica	
		Drawn			
		Gepr.			
		Checked			
03	201200467	24.08.12	IM	Amphenol-Tuchel Electronics GmbH	
02	200700032	16.01.07	CI	M C016 20D003 XXX 1X - SA	
01	200400178	13.01.05	CI	Blatt / Sheet 1	
Index	Änderung / Description	Datum / Date	Name	Ers. f. / Similar to: 1 Bl.	

Mouser Electronics

Authorized Distributor

Click to View Pricing, Inventory, Delivery & Lifecycle Information:

[Amphenol:](#)

[C016 20D003 110 10](#)