

NGTG15N60S1EG

IGBT - Short-Circuit Rated

This Insulated Gate Bipolar Transistor (IGBT) features a robust and cost effective Non-Punch Through (NPT) Trench construction, and provides superior performance in demanding switching applications. Offering both low on state voltage and minimal switching loss, the IGBT is well suited for motor drive control and other hard switching applications.

Features

- Low Saturation Voltage Resulting in Low Conduction Loss
- Low Switching Loss in Higher Frequency Applications
- 5 μ s Short Circuit Capability
- Excellent Current versus Package Size Performance Density
- This is a Pb-Free Device

Typical Applications

- White Goods Appliance Motor Control
- General Purpose Inverter
- AC and DC Motor Control

ABSOLUTE MAXIMUM RATINGS

Rating	Symbol	Value	Unit
Collector-emitter voltage	V_{CES}	650	V
Collector current @ $T_C = 25^\circ\text{C}$ @ $T_C = 100^\circ\text{C}$	I_C	30 15	A
Pulsed collector current, T_{pulse} limited by $T_{J\text{max}}$	I_{CM}	120	A
Gate-emitter voltage	V_{GE}	± 20	V
Power dissipation @ $T_C = 25^\circ\text{C}$ @ $T_C = 100^\circ\text{C}$	P_D	117 47	W
Short circuit withstand time $V_{GE} = 15\text{ V}$, $V_{CE} = 400\text{ V}$, $T_J \leq +150^\circ\text{C}$	t_{SC}	5	μs
Operating junction temperature range	T_J	-55 to +150	$^\circ\text{C}$
Storage temperature range	T_{stg}	-55 to +150	$^\circ\text{C}$
Lead temperature for soldering, 1/8" from case for 5 seconds	T_{SLD}	260	$^\circ\text{C}$

Stresses exceeding those listed in the Maximum Ratings table may damage the device. If any of these limits are exceeded, device functionality should not be assumed, damage may occur and reliability may be affected.



ON Semiconductor[®]

www.onsemi.com

15 A, 650 V
 $V_{CEsat} = 1.5\text{ V}$

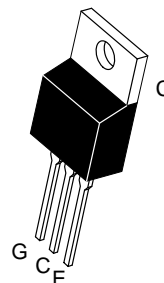
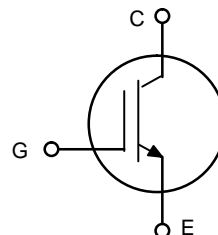

**TO-220
CASE 221A
STYLE 9**

MARKING DIAGRAM

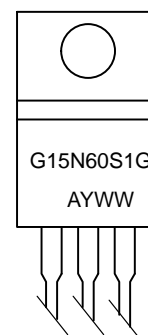

- A = Assembly Location
- Y = Year
- WW = Work Week
- G = Pb-Free Package

ORDERING INFORMATION

Device	Package	Shipping
NGTG15N60S1EG	TO-220 (Pb-Free)	50 Units / Rail

NGTG15N60S1EG

THERMAL CHARACTERISTICS

Rating	Symbol	Value	Unit
Thermal resistance junction to case, for IGBT	$R_{\theta JC}$	1.06	$^{\circ}\text{C}/\text{W}$
Thermal resistance junction to ambient	$R_{\theta JA}$	60	$^{\circ}\text{C}/\text{W}$

ELECTRICAL CHARACTERISTICS ($T_J = 25^{\circ}\text{C}$ unless otherwise specified)

Parameter	Test Conditions	Symbol	Min	Typ	Max	Unit
-----------	-----------------	--------	-----	-----	-----	------

STATIC CHARACTERISTIC

Collector-emitter breakdown voltage, gate-emitter short-circuited	$V_{GE} = 0 \text{ V}, I_C = 500 \mu\text{A}$	$V_{(BR)CES}$	650	-	-	V
Collector-emitter saturation voltage	$V_{GE} = 15 \text{ V}, I_C = 15 \text{ A}$ $V_{GE} = 15 \text{ V}, I_C = 15 \text{ A}, T_J = 150^{\circ}\text{C}$	V_{CEsat}	1.3 1.55	1.5 1.75	1.7 1.95	V
Gate-emitter threshold voltage	$V_{GE} = V_{CE}, I_C = 250 \mu\text{A}$	$V_{GE(th)}$	4.5	5.5	6.5	V
Collector-emitter cut-off current, gate-emitter short-circuited	$V_{GE} = 0 \text{ V}, V_{CE} = 600 \text{ V}$ $V_{GE} = 0 \text{ V}, V_{CE} = 600 \text{ V}, T_J = 150^{\circ}\text{C}$	I_{CES}	-	10	- 200	μA
Gate leakage current, collector-emitter short-circuited	$V_{GE} = 20 \text{ V}, V_{CE} = 0 \text{ V}$	I_{GES}	-	-	100	nA
Forward Transconductance	$V_{CE} = 20 \text{ V}, I_C = 15 \text{ A}$	g_{fs}	-	10.1	-	S

DYNAMIC CHARACTERISTIC

Input capacitance	$V_{CE} = 20 \text{ V}, V_{GE} = 0 \text{ V}, f = 1 \text{ MHz}$	C_{ies}	-	1950	-	pF
Output capacitance		C_{oes}	-	70	-	
Reverse transfer capacitance		C_{res}	-	48	-	
Gate charge total	$V_{CE} = 480 \text{ V}, I_C = 15 \text{ A}, V_{GE} = 15 \text{ V}$	Q_g	-	88	-	nC
Gate to emitter charge		Q_{ge}	-	16	-	
Gate to collector charge		Q_{gc}	-	42	-	

SWITCHING CHARACTERISTIC , INDUCTIVE LOAD

Turn-on delay time	$T_J = 25^{\circ}\text{C}$ $V_{CC} = 400 \text{ V}, I_C = 15 \text{ A}$ $R_g = 22 \Omega$ $V_{GE} = 0 \text{ V} / 15 \text{ V}^*$	$t_{d(on)}$	-	65	-	ns
Rise time		t_r	-	28	-	
Turn-off delay time		$t_{d(off)}$	-	170	-	
Fall time		t_f	-	140	-	
Turn-on switching loss		E_{on}	-	0.550	-	mJ
Turn-off switching loss		E_{off}	-	0.350	-	
Total switching loss		E_{ts}	-	0.900	-	
Turn-on delay time	$T_J = 150^{\circ}\text{C}$ $V_{CC} = 400 \text{ V}, I_C = 15 \text{ A}$ $R_g = 22 \Omega$ $V_{GE} = 0 \text{ V} / 15 \text{ V}^*$	$t_{d(on)}$	-	65	-	ns
Rise time		t_r	-	28	-	
Turn-off delay time		$t_{d(off)}$	-	180	-	
Fall time		t_f	-	260	-	
Turn-on switching loss		E_{on}	-	0.650	-	mJ
Turn-off switching loss		E_{off}	-	0.600	-	
Total switching loss		E_{ts}	-	1.250	-	

Product parametric performance is indicated in the Electrical Characteristics for the listed test conditions, unless otherwise noted. Product performance may not be indicated by the Electrical Characteristics if operated under different conditions.

*Includes diode reverse recovery loss using NGTB15N60S1EG.

NGTG15N60S1EG

TYPICAL CHARACTERISTICS

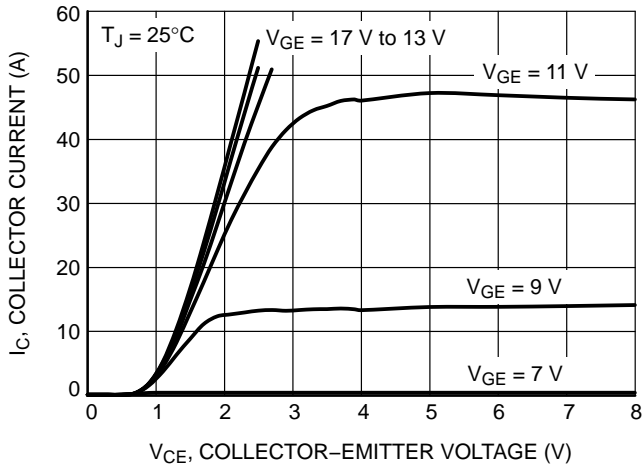

Figure 1. Output Characteristics

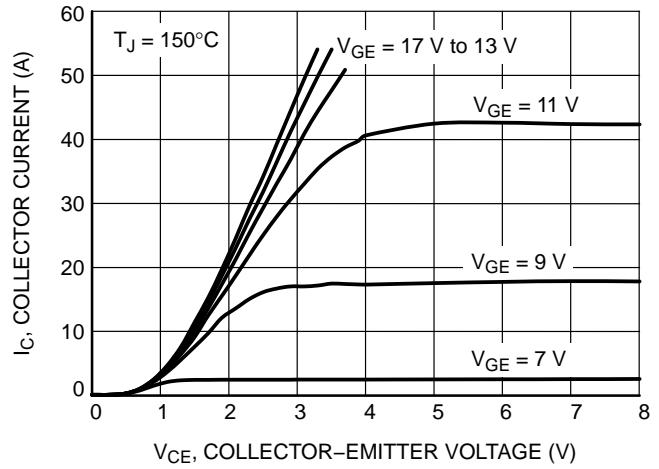

Figure 2. Output Characteristics

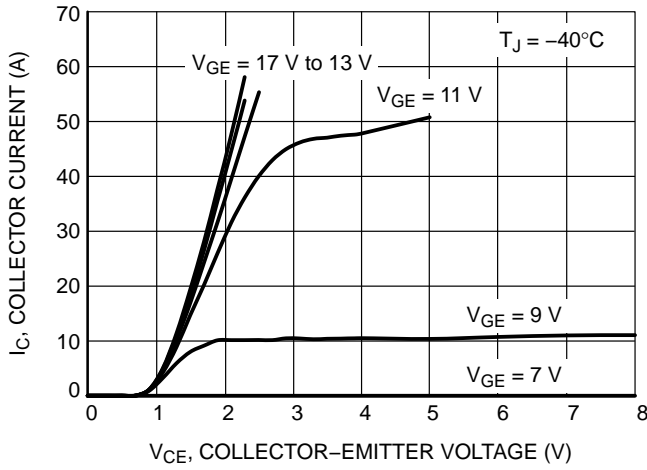

Figure 3. Output Characteristics

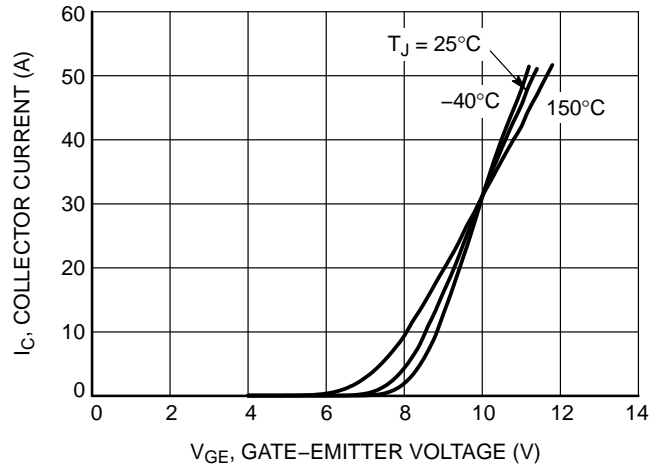

Figure 4. Typical Transfer Characteristics

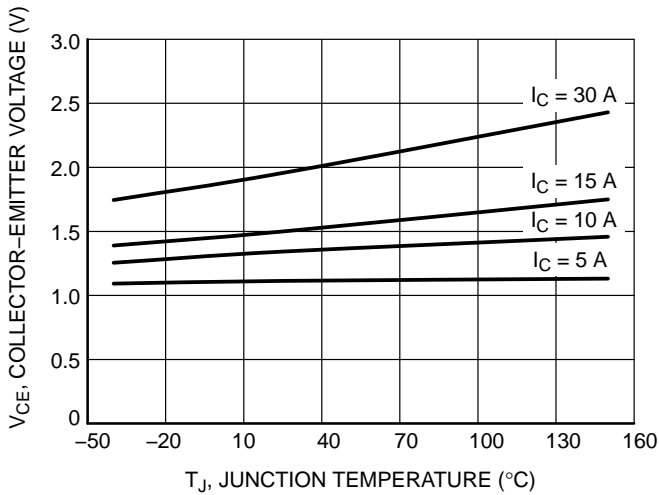

Figure 5. $V_{CE(sat)}$ vs. T_J

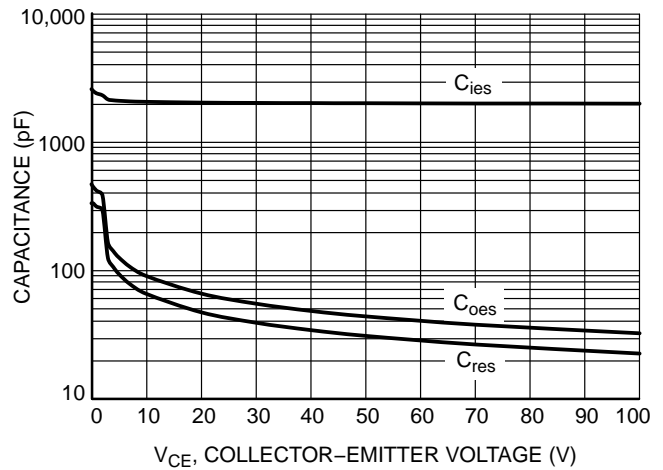

Figure 6. Typical Capacitance

NGTG15N60S1EG

TYPICAL CHARACTERISTICS

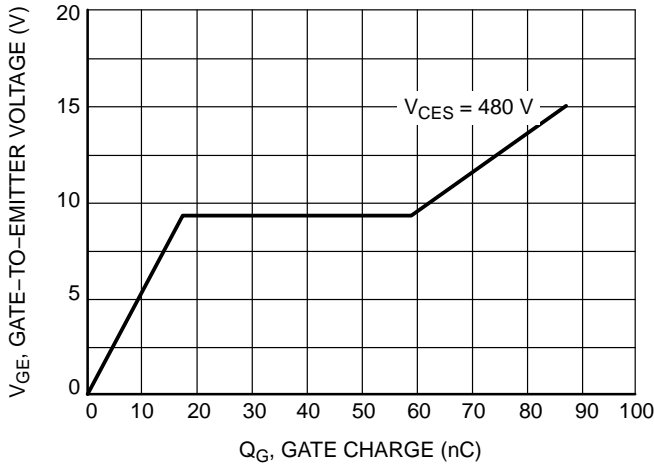

Figure 7. Typical Gate Charge

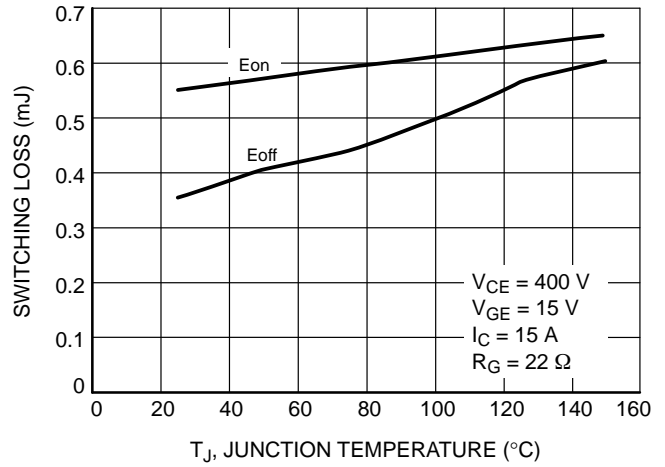

Figure 8. Switching Loss vs. Temperature

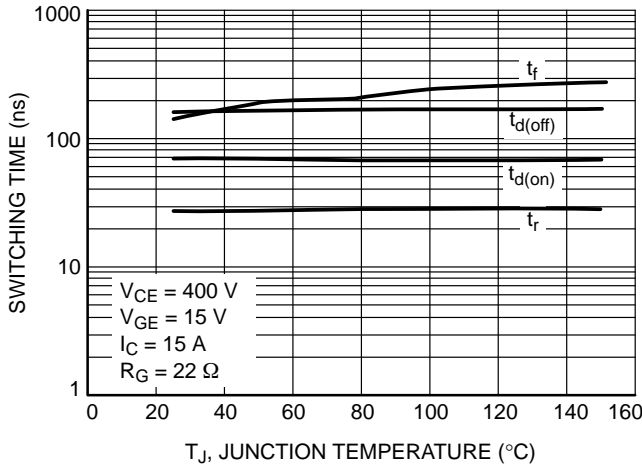

Figure 9. Switching Time vs. Temperature

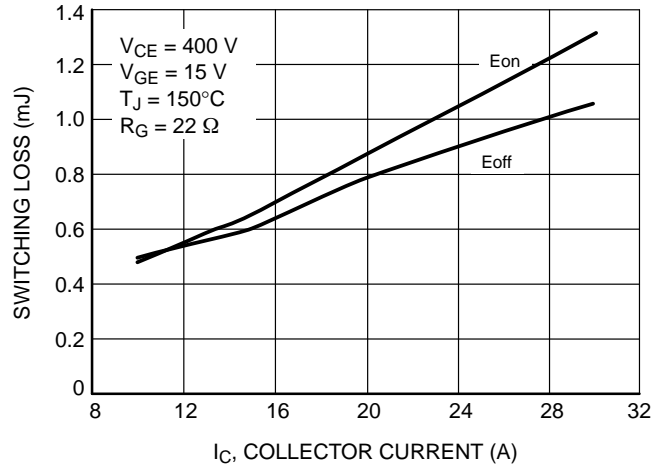

Figure 10. Switching Loss vs. I_C

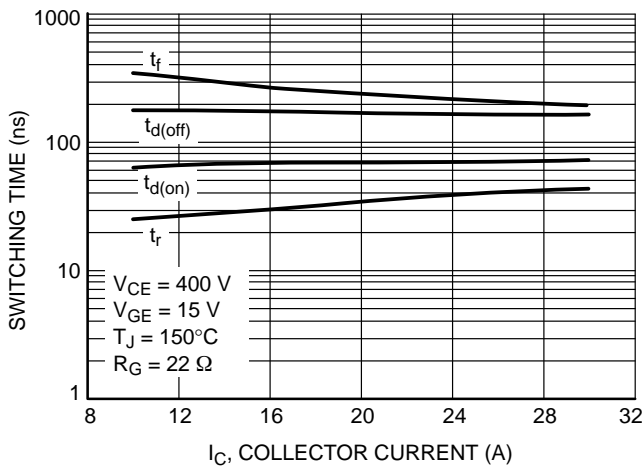

Figure 11. Switching Time vs. I_C

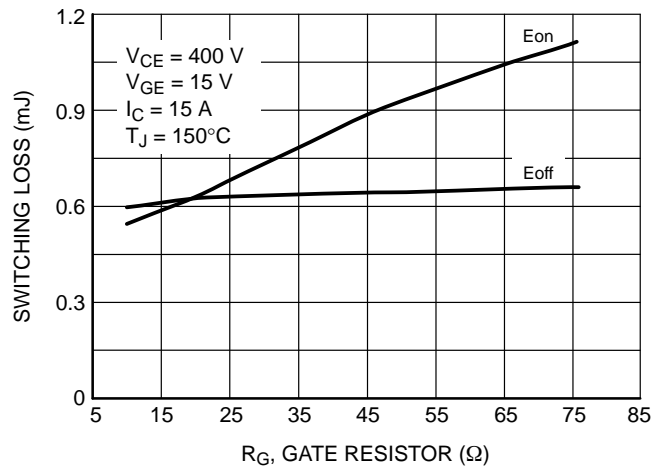

Figure 12. Switching Time vs. R_G

NGTG15N60S1EG

TYPICAL CHARACTERISTICS

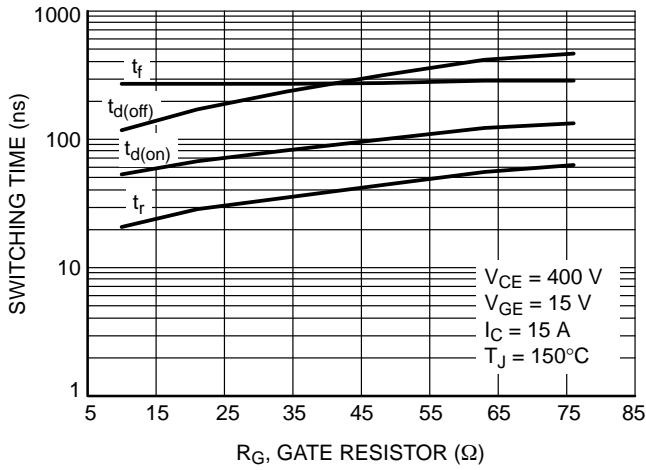

Figure 13. Switching Time vs. R_G

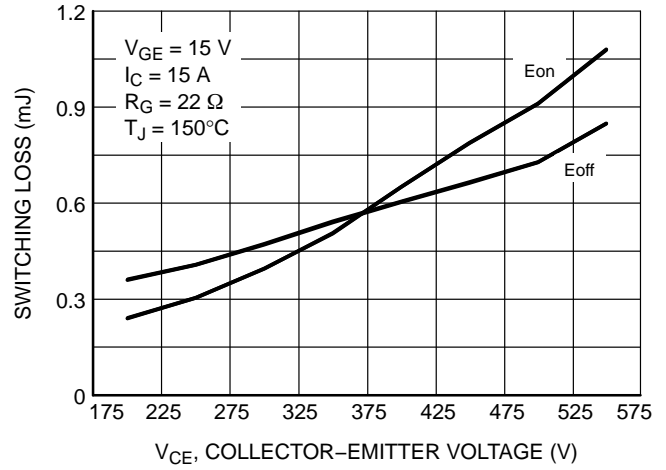

Figure 14. Switching Loss vs. V_{CE}

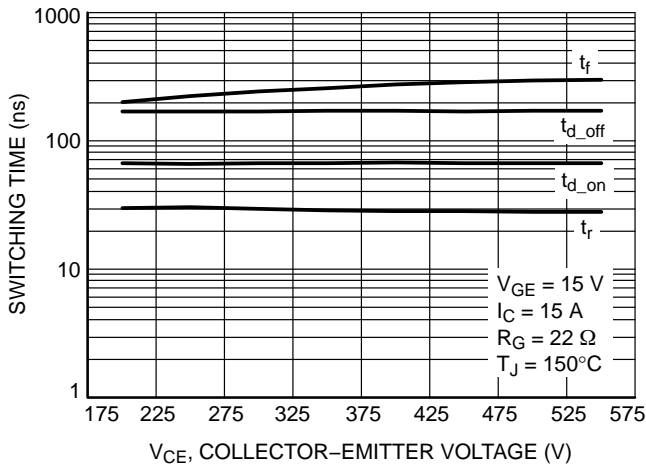

Figure 15. Switching Time vs. V_{CE}

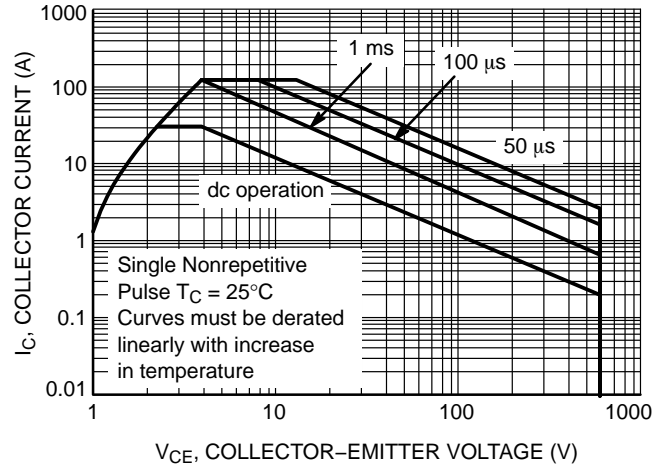

Figure 16. Safe Operating Area

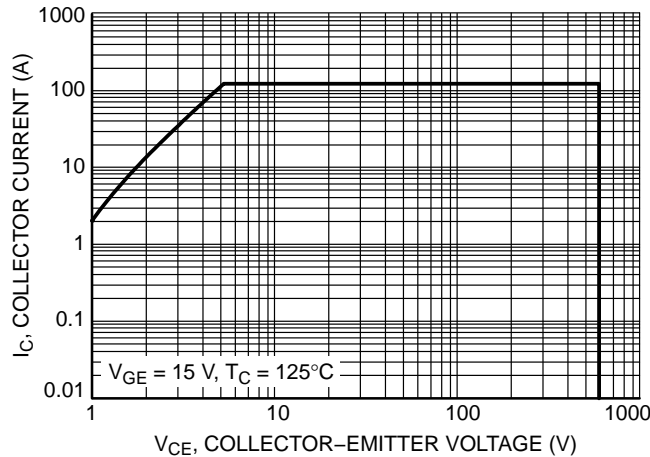

Figure 17. Reverse Bias Safe Operating Area

NGTG15N60S1EG

TYPICAL CHARACTERISTICS

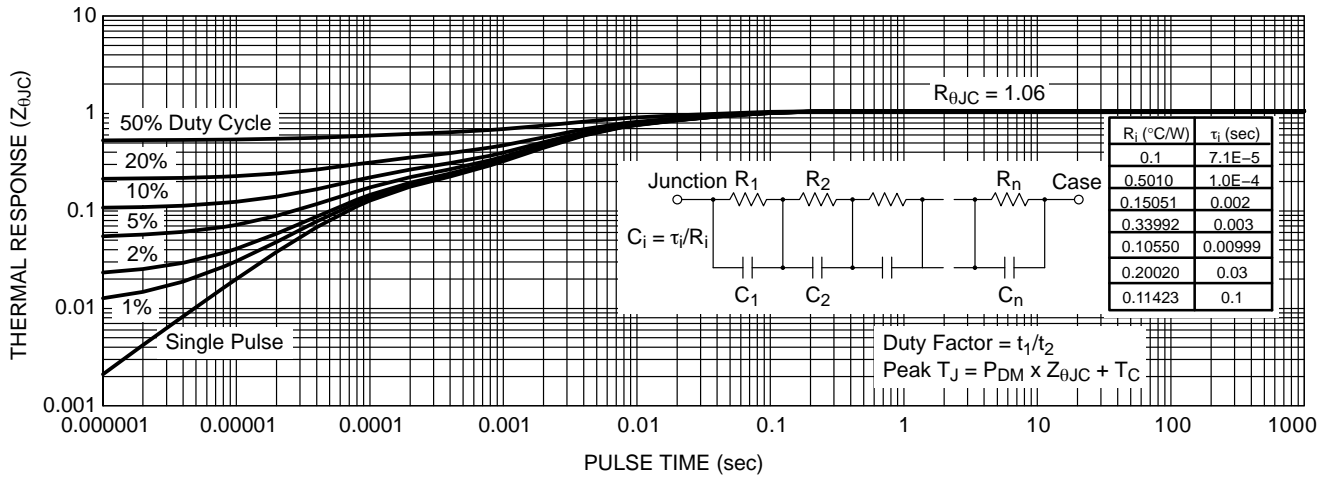

Figure 18. IGBT Transient Thermal Impedance

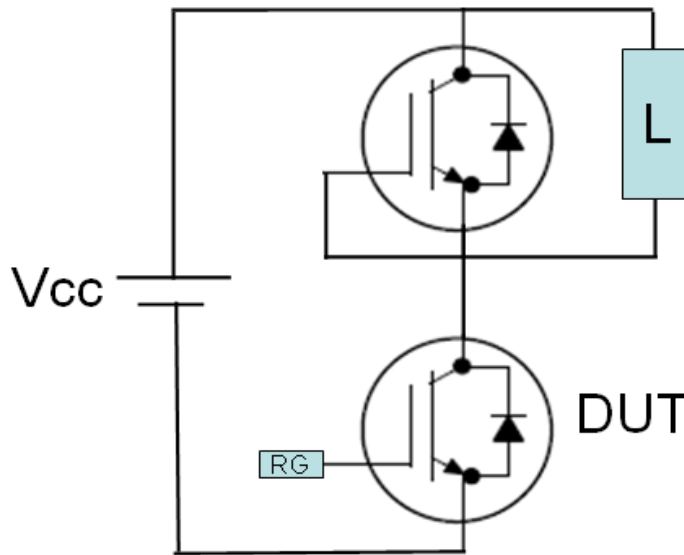

Figure 19. Test Circuit for Switching Characteristics

NGTG15N60S1EG

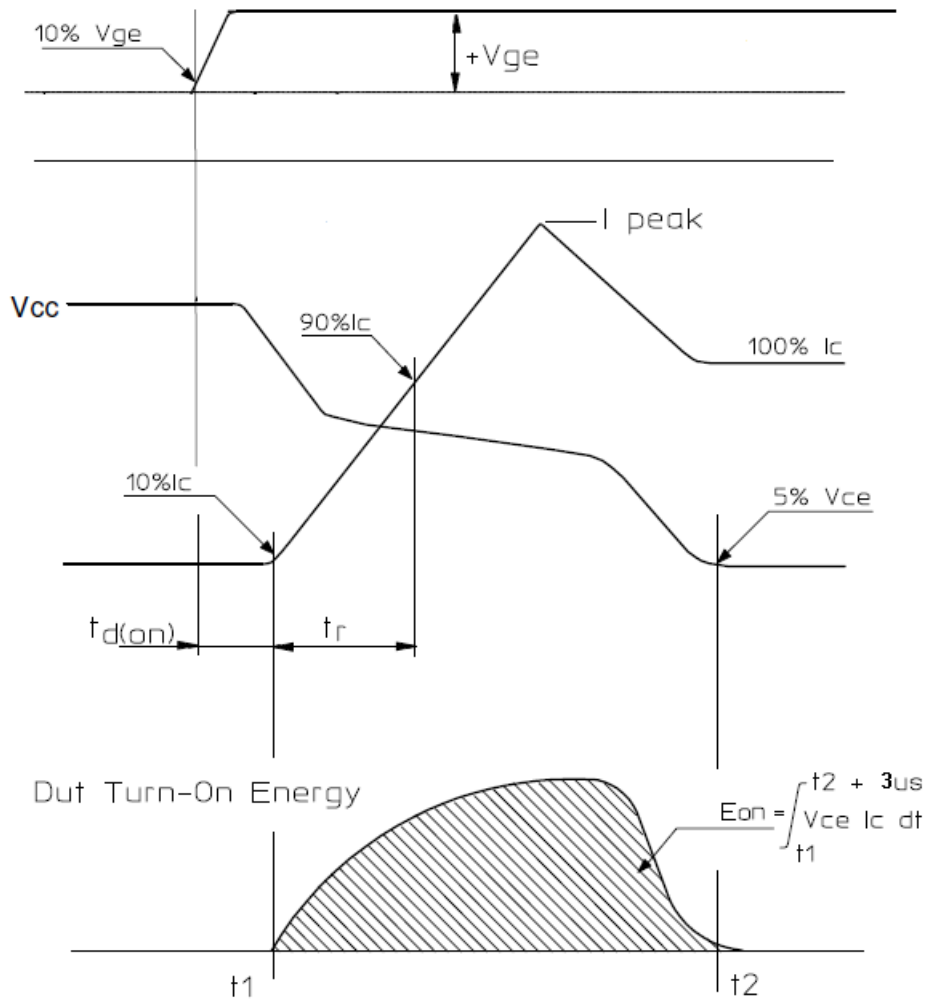

Figure 20. Definition of Turn On Waveform

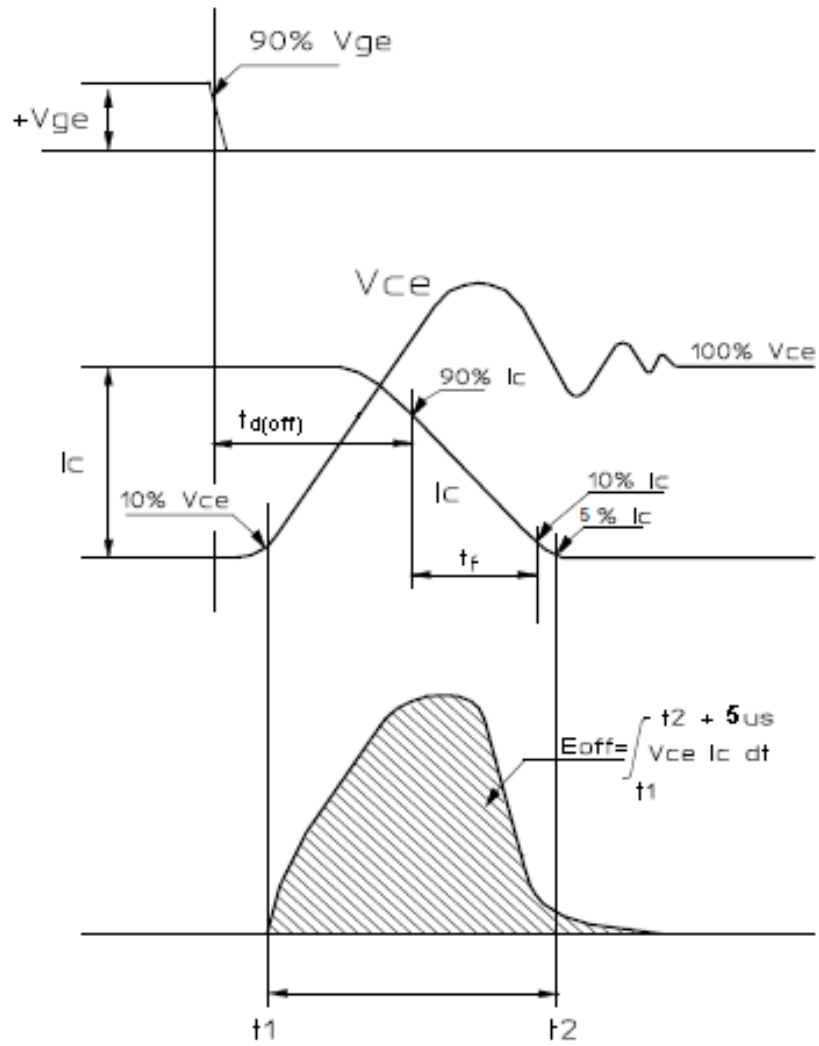
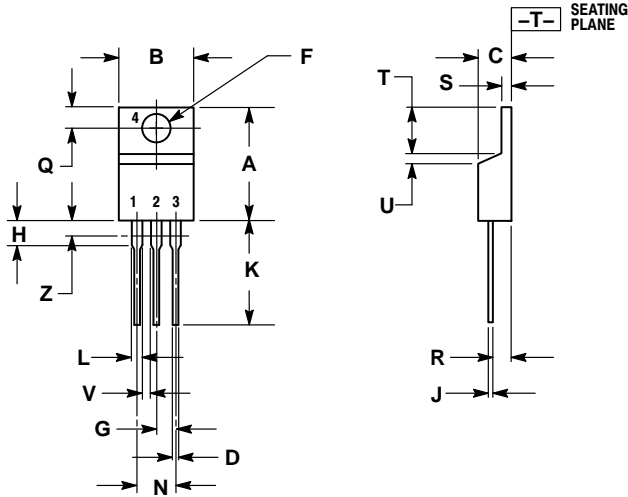

Figure 21. Definition of Turn Off Waveform

NGTG15N60S1EG

PACKAGE DIMENSIONS

TO-220
CASE 221A-09
ISSUE AH



NOTES:

1. DIMENSIONING AND TOLERANCING PER ANSI Y14.5M, 1982.
2. CONTROLLING DIMENSION: INCH.
3. DIMENSION Z DEFINES A ZONE WHERE ALL BODY AND LEAD IRREGULARITIES ARE ALLOWED.

DIM	INCHES		MILLIMETERS	
	MIN	MAX	MIN	MAX
A	0.570	0.620	14.48	15.75
B	0.380	0.415	9.66	10.53
C	0.160	0.190	4.07	4.83
D	0.025	0.038	0.64	0.96
F	0.142	0.161	3.61	4.09
G	0.095	0.105	2.42	2.66
H	0.110	0.161	2.80	4.10
J	0.014	0.024	0.36	0.61
K	0.500	0.562	12.70	14.27
L	0.045	0.060	1.15	1.52
N	0.190	0.210	4.83	5.33
Q	0.100	0.120	2.54	3.04
R	0.080	0.110	2.04	2.79
S	0.045	0.055	1.15	1.39
T	0.235	0.255	5.97	6.47
U	0.000	0.050	0.00	1.27
V	0.045	---	1.15	---
Z	---	0.080	---	2.04

STYLE 9:

- PIN 1. GATE
- COLLECTOR
- EMITTER
- COLLECTOR

ON Semiconductor and are registered trademarks of Semiconductor Components Industries, LLC (SCILLC). SCILLC owns the rights to a number of patents, trademarks, copyrights, trade secrets, and other intellectual property. A listing of SCILLC's product/patent coverage may be accessed at www.onsemi.com/site/pdf/Patent-Marking.pdf. SCILLC reserves the right to make changes without further notice to any products herein. SCILLC makes no warranty, representation or guarantee regarding the suitability of its products for any particular purpose, nor does SCILLC assume any liability arising out of the application or use of any product or circuit, and specifically disclaims any and all liability, including without limitation special, consequential or incidental damages. "Typical" parameters which may be provided in SCILLC data sheets and/or specifications can and do vary in different applications and actual performance may vary over time. All operating parameters, including "Typicals" must be validated for each customer application by customer's technical experts. SCILLC does not convey any license under its patent rights nor the rights of others. SCILLC products are not designed, intended, or authorized for use as components in systems intended for surgical implant into the body, or other applications intended to support or sustain life, or for any other application in which the failure of the SCILLC product could create a situation where personal injury or death may occur. Should Buyer purchase or use SCILLC products for any such unintended or unauthorized application, Buyer shall indemnify and hold SCILLC and its officers, employees, subsidiaries, affiliates, and distributors harmless against all claims, costs, damages, and expenses, and reasonable attorney fees arising out of, directly or indirectly, any claim of personal injury or death associated with such unintended or unauthorized use, even if such claim alleges that SCILLC was negligent regarding the design or manufacture of the part. SCILLC is an Equal Opportunity/Affirmative Action Employer. This literature is subject to all applicable copyright laws and is not for resale in any manner.

PUBLICATION ORDERING INFORMATION

LITERATURE FULFILLMENT:

Literature Distribution Center for ON Semiconductor
P.O. Box 5163, Denver, Colorado 80217 USA
Phone: 303-675-2175 or 800-344-3860 Toll Free USA/Canada
Fax: 303-675-2176 or 800-344-3867 Toll Free USA/Canada
Email: orderlit@onsemi.com

N. American Technical Support: 800-282-9855 Toll Free
USA/Canada
Europe, Middle East and Africa Technical Support:
Phone: 421 33 790 2910
Japan Customer Focus Center
Phone: 81-3-5817-1050

ON Semiconductor Website: www.onsemi.com

Order Literature: <http://www.onsemi.com/orderlit>

For additional information, please contact your local Sales Representative

Mouser Electronics

Authorized Distributor

Click to View Pricing, Inventory, Delivery & Lifecycle Information:

[ON Semiconductor:](#)

[NGTG15N60S1EG](#)