

THIS DRAWING IS UNPUBLISHED.
VERTRAULICHE UNVERÖFFENTLICHTE ZEICHNUNG
© COPYRIGHT - By -
RELEASED FOR PUBLICATION
FREI FUER VERÖFFENTLICHUNG
ALL RIGHTS RESERVED
ALLE RECHTE VORBEHALTEN

REVISIONS ÄNDERUNGEN		DATE	DWN	APVD
P	LTR	DESCRIPTION BESCHREIBUNG		
E		P & P ADAPTER FOR 1-966926-0 and 1- -2 IS CHANGED	10FEB2017	RP PS

EMPFOHLENES LEITERPLATTEN-LAYOUT

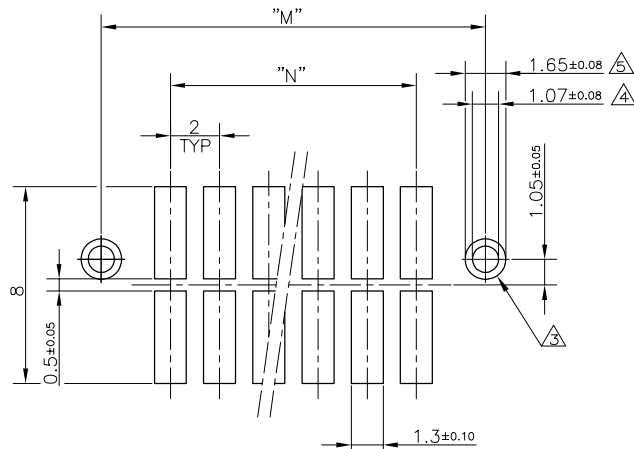

- BEMERKUNGEN:
- △ STECKBEREICH: MIN. 0.8µm Au ÜBER 1.27µm Ni
LÖTBEREICH: 2.5-4.0µm Sn ÜBER 1.27µm Ni
 - 2. VERPACKUNG DER STIFTLLEISTEN SIEHE ZEICHN. 966926
 - △ BOHRUNG FÜR SHROUD-BEFESTIGUNG
 - △ GEBOHRTES LOCH: Ø1.18
PLATTIERUNG: Sn ÜBER MIN. 0.025 Cu
 - △ LÖTAUGE AUF DER PLATINENUNTERSEITE: Ø1.65 MIN
 - △ PN 176135 ODER
△ PN 964 976 MIT PN 969047 / 969129
 - △ OBSOLETE PARTS: OBSOLETE CIS STREAMLINING PER D.RENAUD/D.SINISI
 - △ GOLD FLASH IS PERMITTED ON THE SURFACE SHOWN(TOP SURFACE OF SOLDER TAIL)

GEGENSTECKER: △
MATING PART: △

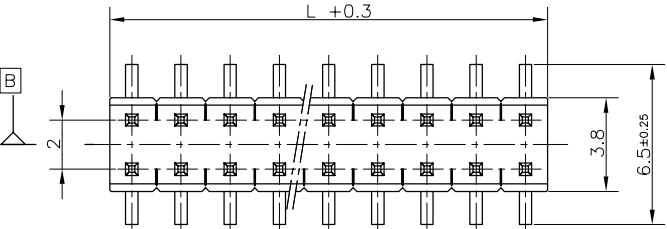
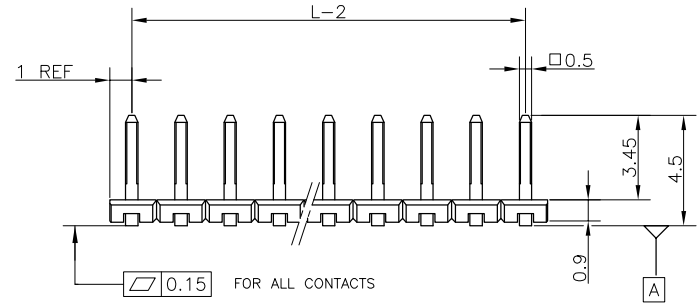
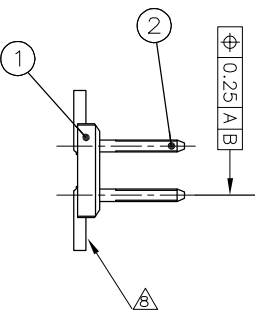

POS PER ROW	L	M±0.05	N	PART NO
2	4.0	7.6	2	966926-2
3	6.0	9.6	4	966926-3
4	8.0	11.6	6	966926-4
5	10.0	13.6	8	966926-5
6	12.0	15.6	10	966926-6
7	14.0	17.6	12	966926-7
8	16.0	19.6	14	966926-8
9	18.0	21.6	16	966926-9
10	20.0	23.6	18	1-966926-0
11	22.0	25.6	20	1-966926-1
12	24.0	27.6	22	1-966926-2
13	26.0			
14	28.0			
15	30.0			
16	32.0			

OBSOLETE △
OBSOLETE △

△	CuZn	STIFTKONTAKT	2
SCHWARZ	LCP	AMPMODU STIFTGEHÄUSE	1
ÖBERFLÄCHE FRABE	WERKSTOFF	BENENNUNG EINZELTEIL	POS

THIS DRAWING IS A CONTROLLED DOCUMENT. DIESE ZEICHNUNG IST EIN KONTROLLIERTES DOKUMENT.		DWN A.HOFFMANN 11-APR-96	TE Connectivity	
DIMENSIONS: MASSENEHEITEN: mm		CHK M.SCHAARSCHMIDT 11-APR-96		
TOLERANCES UNLESS OTHERWISE SPECIFIED: ALLGEMEINTOLERANZEN		APVD G.FELDMEIER 11-APR-96	NAME AMPMODU 2mm, SMD, PACKED IN BLISTER BELT	
		PRODUCT SPEC PRODUKTSPEZ. 108-18544	-	
MATERIAL		APPLICATION SPEC VERARBEITUNGSSPEZ.	SIZE A3	CAGE CODE 00779
FINISH/ÖBERFLÄCHE/FARBE		WEIGHT GEWICHT	DRAWING NO ZEICHNUNGS-NR. C-966926	RESTRICTED TO NUR FUER
		CUSTOMER DRAWING/KUNDENZEICHNUNG	SCALE MASSTAB 5:1	SHEET BLATT 1 OF VON 3
			REV E	

THIS DRAWING IS UNPUBLISHED.
 VERTRAULICHE UNVERÖFFENTLICHTE ZEICHNUNG
 © COPYRIGHT - By -
 RELEASED FOR PUBLICATION
 FREI FUER VERÖFFENTLICHUNG
 ALL RIGHTS RESERVED.
 ALLE RECHTE VORBEHALTEN

REVISIONS ÄNDERUNGEN					
P	LTR	DESCRIPTION BESCHREIBUNG	DATE	DWN	APVD
-	-	SEE SHEET 1	-	-	-

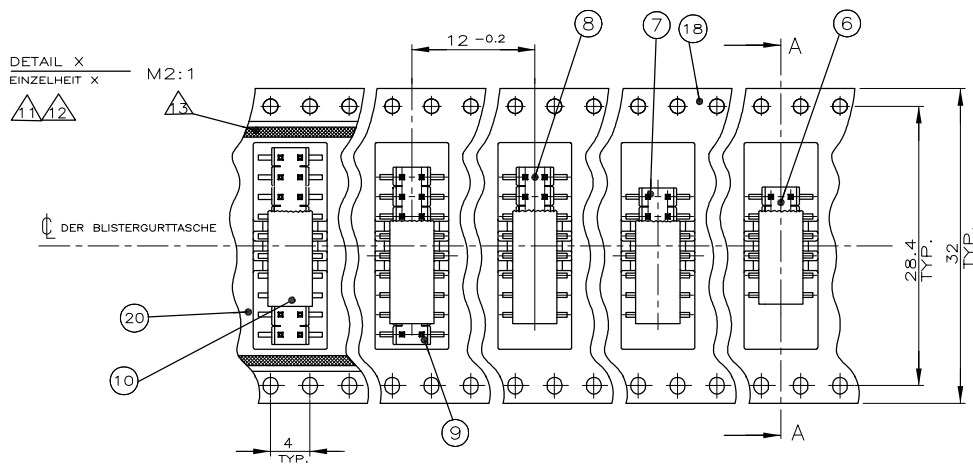

SECTION A-A
 SCHNITT A-A

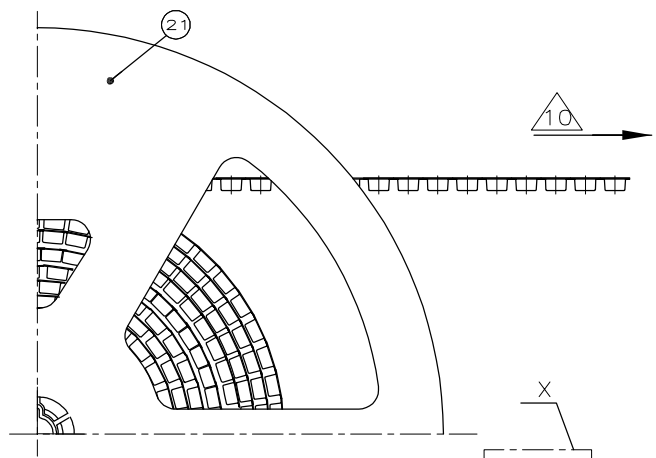
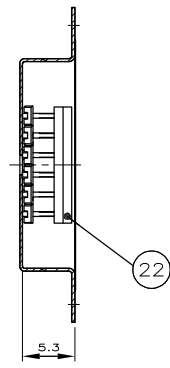

DETAIL X
 EINZELHEIT X M2:1

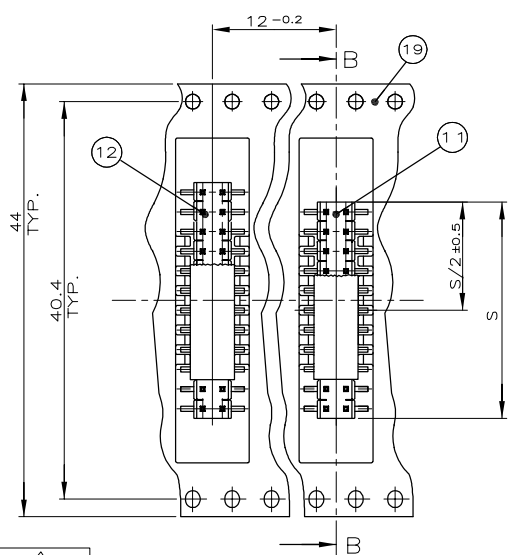

SECTION B-B
 SCHNITT B-B

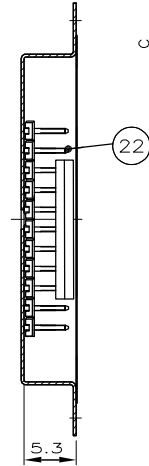

ABMESSUNGEN, MATERIALIEN UND OBERFLÄCHE /
 FARBE DER STIFTLISTEN SIEHE ZEICHNUNG 966916

POLZAHL	BESTELL-NR.	ITEM	SPULE Ø _g /Ø _k x c
2x2	966926-2	②	Ø330/62x22.4
2x3	966926-3	③	Ø330/62x22.4
2x4	966926-4	④	Ø330/62x22.4
2x5	966926-5	⑤	Ø330/62x22.4
2x6	966926-6	⑥	Ø330/100x38.4
2x7	966926-7	⑦	Ø330/100x38.4
2x8	966926-8	⑧	Ø330/100x38.4
2x9	966926-9	⑨	Ø330/100x38.4
2x10	1-966926-0	⑩	Ø330/100x38.4
2x11	1-966926-1	⑪	Ø330/100x50.4
2x12	1-966926-2	⑫	Ø330/100x50.4
2x2	5-966926-2	⑬	Ø330/62x22.4
2x13	-		
2x14	-		
2x15	-		
2x16	-		

OBSELETE

OBSELETE

THIS DRAWING IS A CONTROLLED DOCUMENT.
 DIESE ZEICHNUNG IST EIN KONTROLLIERTES DOKUMENT.

DIMENSIONS: MASSENEHTEIN: mm	TOLERANCES UNLESS OTHERWISE SPECIFIED: ALLGEMEINTOLERANZEN
0 PLC ± 0.25	1 PLC ± 0.25
1 PLC ± 0.25	2 PLC ± 0.25
2 PLC ± 0.25	3 PLC ± 0.25
3 PLC ± 0.25	4 PLC ± 0.25
4 PLC ± 0.25	ANGLES / WINKEL ± 0.5
MATERIAL	FINISH/OBERFLÄCHE/FARBE

DWN	11-APR-96
CHK	11-APR-96
APVD	11-APR-96
PRODUCT SPEC	108-18544
APPLICATION SPEC	
WEIGHT	
GEWICHT	

TE Connectivity			
NAME			
AMPMODU 2mm, SMD, PACKED IN BLISTER BELT			
SIZE	CAGE CODE	DRAWING NO. ZEICHNUNGS-NR.	RESTRICTED TO NUR FUER
A3	00779	C-966926	-
CUSTOMER DRAWING/KUNDENZEICHNUNG		SCALE MASSSTAB 1:2	SHEET BLATT 2 OF 3
		REV	E

THIS DRAWING IS UNPUBLISHED.
 VERTRAULICHE UNVERÖFFENTLICHTE ZEICHNUNG
 RELEASED FOR PUBLICATION
 FREI FÜR VERÖFFENTLICHUNG
 ALL RIGHTS RESERVED.
 ALLE RECHTE VORBEHALTEN

REVISIONS ÄNDERUNGEN		DATE	DWN	APVD
P	LTR	DESCRIPTION BESCHREIBUNG		
-	-	SEE SHEET 1	-	-

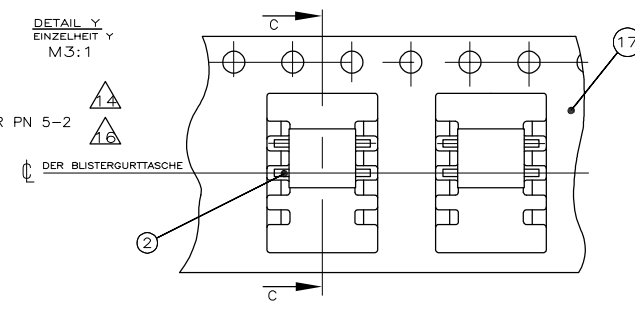
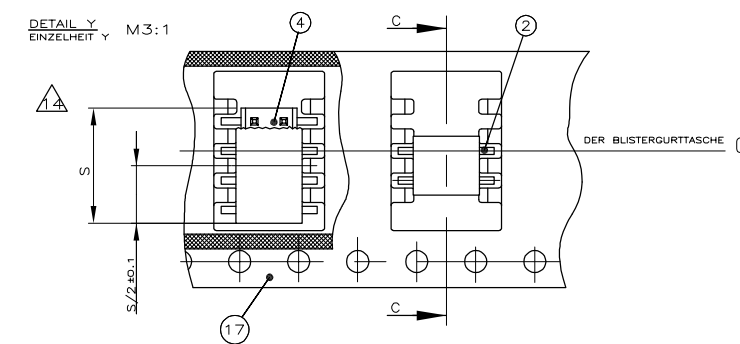
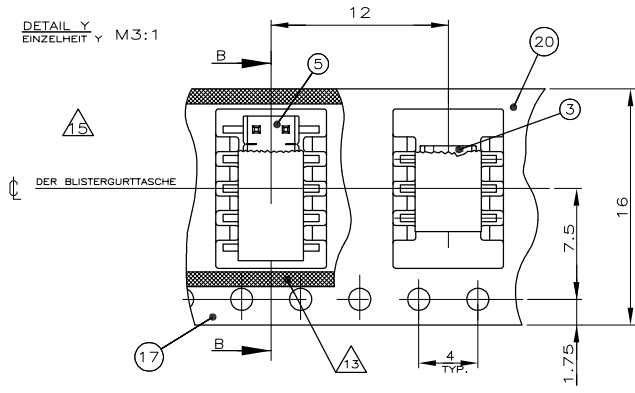

SECTION B-B
SCHNITT B-B

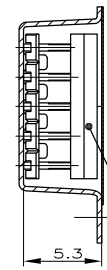

SECTION C-C
SCHNITT C-C

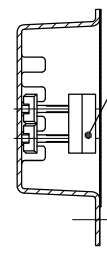

SECTION C-C
SCHNITT C-C

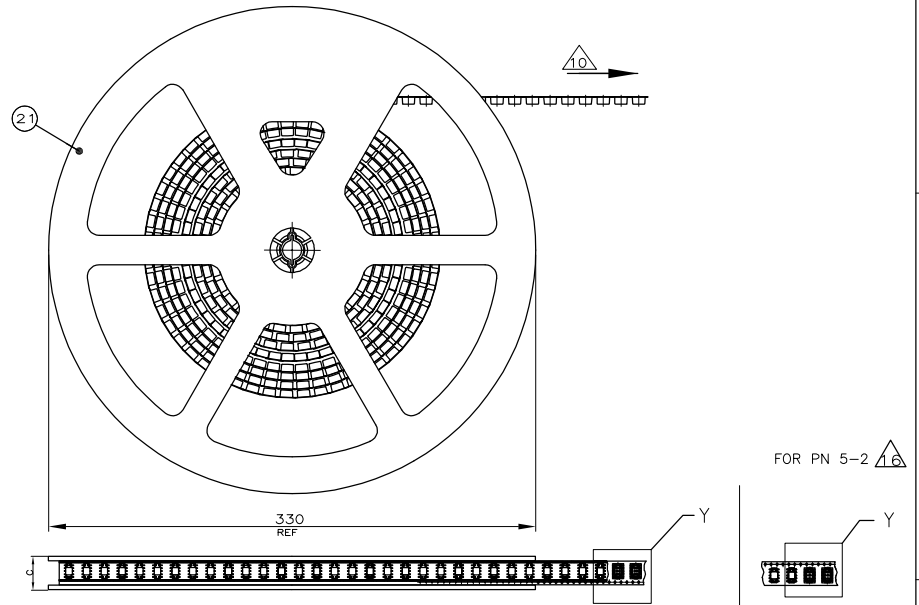
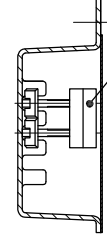

- BEMERKUNGEN:
- 9 VERPACKUNGSEINHEIT=MINDESTBESTELLMENGE; 1000 STIFBLEISTEN PRO SPULE
 - 10 ABWICKELRICHTUNG
 - 11 STIFBLEISTEN MIT GERADER POLZAHL JE REIHE SIND MITTIG IN DER BLISTERGURTASCHE POSITIONIERT.
 - 12 STIFBLEISTEN MIT UNGERADER POLZAHL JE REIHE SIND VERSETZT ZUR MITTE DER BLISTERGURTASCHE POSITONIERT.
 - 13 ABDECKFOLIE MIT BLISTERGURT VERSCHWEISST / VERKLEBT
 - 14 STIFBLEISTEN MIT GERADER POLZAHL JE REIHE SIND VERSETZT ZUR MITTE DER BLISTERGURTASCHE POSITIONIERT.
 - 15 STIFBLEISTEN MIT UNGERADER POLZAHL JE REIHE SIND MITTIG IN DER BLISTERGURTASCHE POSITIONIERT.
 - 16 UMGEKEHRT GEWICKELT.

THIS DRAWING IS A CONTROLLED DOCUMENT. DIESE ZEICHNUNG IST EIN KONTROLLIERTES DOKUMENT.		DWN F.REICHARDT 18-MAY-98	TE Connectivity	
DIMENSIONS: MASSEINHEITEN: mm		CHK F.REICHARDT 18-MAY-98		
TOLERANCES UNLESS OTHERWISE SPECIFIED: ALLGEMEINTOLERANZEN		APVD G.FELDMEIER	NAME AMPMODU 2mm, SMD, PACKED IN BLISTER BELT	
0 PLC ± 0.25 1 PLC ± 0.25 2 PLC ± 0.25 3 PLC ± 0.25 4 PLC ± 0.25 ANGLES / WINKEL ± 0.5		PRODUCT SPEC PRODUKTSPEZ. 108-18544	DRAWING NO ZEICHNUNGS-NR. C-966926	
MATERIAL		FINISH/OBERFLAECHE/FARBE	WEIGHT GEWICHT A3	RESTRICTED TO NUR FÜR
		CUSTOMER DRAWING/KUNDENZEICHNUNG	SCALE MASSSTAB 1:3	SHEET BLATT 3 of 3
			REV E	

Mouser Electronics

Authorized Distributor

Click to View Pricing, Inventory, Delivery & Lifecycle Information:

[TE Connectivity:](#)

[5-966926-2](#)