

TPA2016D2 2.8-W/Ch Stereo Class-D Audio Amplifier With Dynamic Range Compression and Automatic Gain Control

1 Features

- Filter-Free Class-D Architecture
- 1.7 W/Ch Into 8 Ω at 5 V (10% THD+N)
- 750 mW/Ch Into 8 Ω at 3.6 V (10% THD+N)
- 2.8 W/Ch Into 4 Ω at 5 V (10% THD+N)
- 1.5 W/Ch Into 4 Ω at 3.6 V (10% THD+N)
- Power Supply Range: 2.5 V to 5.5 V
- Flexible Operation With or Without I²C
- Programmable DRC and AGC Parameters
- Digital I²C Volume Control
- Selectable Gain from –28 dB to 30 dB in 1-dB Steps (When Compression is Used)
- Selectable Attack, Release, and Hold Times
- 4 Selectable Compression Ratios
- Low Supply Current: 3.5 mA
- Low Shutdown Current: 0.2 μ A
- High PSRR: 80 dB
- Fast Start-Up Time: 5 ms
- AGC Enable or Disable Function
- Limiter Enable or Disable Function
- Short-Circuit and Thermal Protection
- Space-Saving Package
 - 2.2 mm \times 2.2 mm Nano-Free™ DSBGA (YZH)

2 Applications

- Wireless or Cellular Handsets and PDAs
- Portable Navigation Devices
- Portable DVD Players
- Notebook PCs
- Portable Radios
- Portable Games
- Educational Toys
- USB Speakers

3 Description

The TPA2016D2 device is a stereo, filter-free Class-D audio power amplifier with volume control, dynamic range compression (DRC), and automatic gain control (AGC). It is available in a 2.2 mm \times 2.2 mm DSBGA package and 20-pin QFN package.

The DRC and AGC function in the TPA2016D2 is programmable through a digital I²C interface. The DRC and AGC function can be configured to automatically prevent distortion of the audio signal and enhance quiet passages that are normally not heard. The DRC and AGC can also be configured to protect the speaker from damage at high power levels and compress the dynamic range of music to fit within the dynamic range of the speaker. The gain can be selected from –28 dB to +30 dB in 1-dB steps.

The TPA2016D2 is capable of driving 1.7 W/Ch at 5 V or 750 mW/Ch at 3.6 V into 8- Ω load or 2.8 W/Ch at 5 V or 1.5 W/Ch at 3.6 V into 4- Ω load. The device features independent software shutdown controls for each channel and also provides thermal and short-circuit protection.

In addition to these features, a fast start-up time and small package size make the TPA2016D2 an ideal choice for cellular handsets, PDAs, and other portable applications.

Device Information⁽¹⁾

| PART NUMBER | PACKAGE | BODY SIZE (NOM) |
|-------------|------------|--------------------------|
| TPA2016D2 | DSBGA (16) | 2.20 mm \times 2.20 mm |
| | QFN (20) | 4.00 mm \times 4.00 mm |

(1) For all available packages, see the orderable addendum at the end of the data sheet.

Simplified Application Diagram

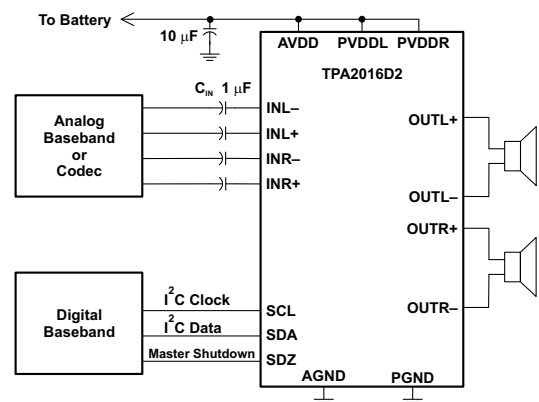

Copyright © 2016, Texas Instruments Incorporated



Table of Contents

| | | | |
|--------------------------------------------------|-----------|------------------------------------------------------------------|-----------|
| 1 Features | 1 | 9.3 Feature Description | 12 |
| 2 Applications | 1 | 9.4 Device Functional Modes | 21 |
| 3 Description | 1 | 9.5 Programming | 21 |
| 4 Revision History | 2 | 9.6 Register Maps | 24 |
| 5 Device Comparison Table | 4 | 10 Application and Implementation | 29 |
| 6 Pin Configuration and Functions | 4 | 10.1 Application Information | 29 |
| 7 Specifications | 5 | 10.2 Typical Applications | 29 |
| 7.1 Absolute Maximum Ratings | 5 | 11 Power Supply Recommendations | 32 |
| 7.2 ESD Ratings | 5 | 11.1 Power Supply Decoupling Capacitors | 32 |
| 7.3 Recommended Operating Conditions | 5 | 12 Layout | 32 |
| 7.4 Thermal Information | 5 | 12.1 Layout Guidelines | 32 |
| 7.5 Electrical Characteristics | 6 | 12.2 Layout Examples | 34 |
| 7.6 I ² C Timing Requirements | 6 | 12.3 Efficiency and Thermal Considerations | 36 |
| 7.7 Dissipation Ratings | 6 | 13 Device and Documentation Support | 37 |
| 7.8 Operating Characteristics | 7 | 13.1 Device Support | 37 |
| 7.9 Typical Characteristics | 8 | 13.2 Community Resources | 37 |
| 8 Parameter Measurement Information | 11 | 13.3 Trademarks | 37 |
| 9 Detailed Description | 12 | 13.4 Electrostatic Discharge Caution | 37 |
| 9.1 Overview | 12 | 13.5 Glossary | 37 |
| 9.2 Functional Block Diagram | 12 | 14 Mechanical, Packaging, and Orderable Information | 37 |

4 Revision History

NOTE: Page numbers for previous revisions may differ from page numbers in the current version.

| Changes from Revision D (August 2009) to Revision E | Page |
|---------------------------------------------------------------------------------------------------------------------------------------------------------------------------------------------------------------------------------------------------------------------------------------------|----------|
| • Added ESD Ratings table, Feature Description section, Device Functional Modes, Application and Implementation section, Power Supply Recommendations section, Layout section, Device and Documentation Support section, and Mechanical, Packaging, and Orderable Information section. | 1 |

| Changes from Revision C (October 2008) to Revision D | Page |
|----------------------------------------------------------------------------------|-----------|
| • Added Feature: 2.8 W/Ch Into 4 Ω at 5 V (10% THD+N) | 1 |
| • Added Feature: 1.5 W/Ch Into 4 Ω at 3.6 V (10% THD+N) | 1 |
| • Added the RTJ (QFN) pin out package | 4 |
| • Changed the RTJ Package Options to the Available Options Table..... | 4 |
| • Changed I _{SW} S Software shutdown 3.6V From: Max 60 to: 70 μA | 6 |
| • Changed I _{SW} S Software shutdown 5.5V From: Max 100 to 110 μA | 6 |
| • Changed Output offset TYP From 0 mV To: 2 mV..... | 6 |
| • Added the RTJ (QFN) package to the Dissipation Ratings Table..... | 6 |
| • Deleted Table of Graphs from the Typical Characteristics..... | 8 |
| • Added 4Ω Efficiency Graph | 9 |
| • Added 4Ω Total Power Dissipation Graph | 9 |
| • Added 4Ω Total Supply Current Graph | 9 |
| • Added QFN Output Power Graph..... | 10 |
| • Added text notes 4 and 5 to the Test Setup for Graphs..... | 11 |

Changes from Revision B (June 2008) to Revision C **Page**

- Changed R_{LOAD} from 6.4 Ω to 3.2 Ω [5](#)
-

Changes from Revision A (June 2008) to Revision B **Page**

- Changed Feature High PSRR From: 75 dB at 217 Hz To: 80 dB..... [1](#)
 - Added 00 to Default column [25](#)
 - Added 00 to Default column [26](#)
 - Added 00 to Default column [26](#)
-

Changes from Original (June 2008) to Revision A **Page**

- Changed From: 1.4 W/Ch Into 8 Ω at 5 V (10% THD+N) To: 1.7 W/Ch Into 8 Ω at 5 V (10% THD+N) [1](#)
-

5 Device Comparison Table

| DEVICE NUMBER | SPEAKER AMP TYPE | SPECIAL FEATURE | OUTPUT POWER (W) | PSRR (dB) |
|---------------|------------------|-----------------|------------------|-----------|
| TPA2012D2 | Class D | — | 2.1 | 71 |
| TPA2016D2 | Class D | AGC/DRC | 2.8 | 80 |
| TPA2026D2 | Class D | AGC/DRC | 3.2 | 80 |

6 Pin Configuration and Functions

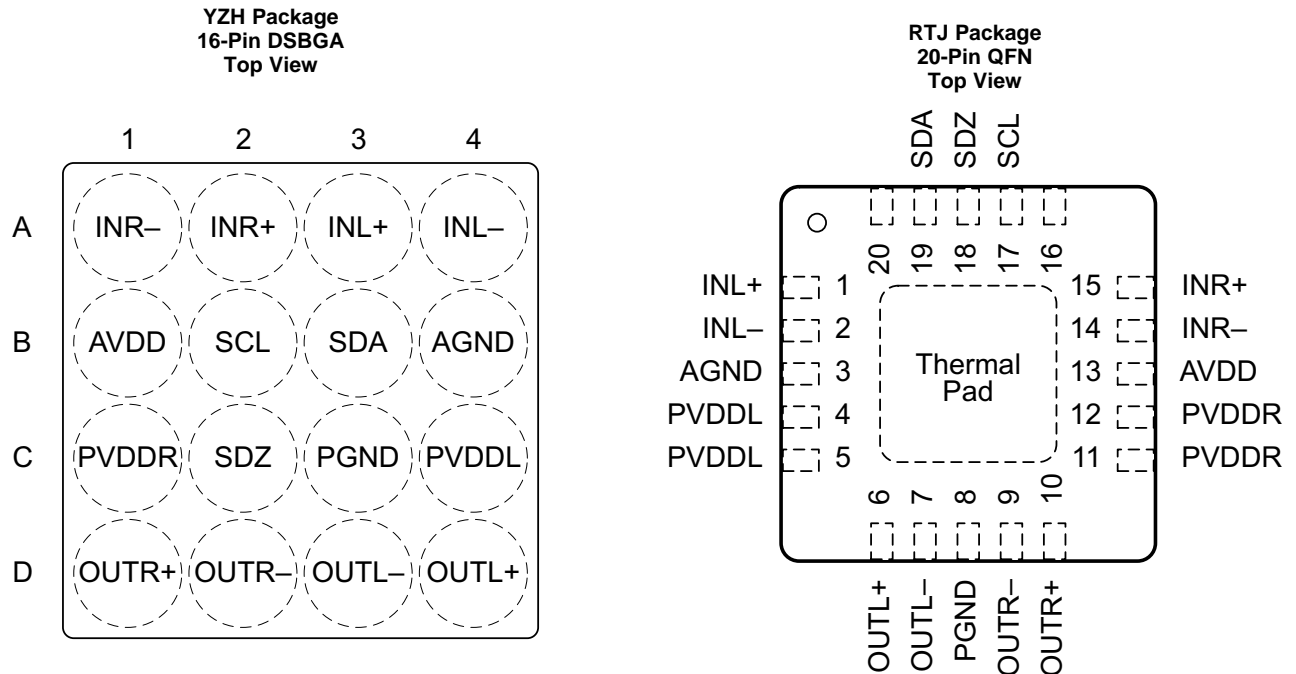

Pin Functions

| NAME | PIN | | TYPE | DESCRIPTION |
|-------|-------|--------|------|-----------------------------------------------------------------|
| | DSBGA | QFN | | |
| INR+ | A2 | 15 | I | Right channel positive audio input |
| INR- | A1 | 14 | I | Right channel negative audio input |
| INL+ | A3 | 1 | I | Left channel positive audio input |
| INL- | A4 | 2 | I | Left channel negative audio input |
| SDZ | C2 | 18 | I | Shutdown terminal (active low) |
| SDA | B3 | 19 | I/O | I ² C data interface |
| SCL | B2 | 17 | I | I ² C clock interface |
| OUTR+ | D1 | 10 | O | Right channel positive differential output |
| OUTR- | D2 | 9 | O | Right channel negative differential output |
| OUTL+ | D4 | 6 | O | Left channel positive differential output |
| OUTL- | D3 | 7 | O | Left channel negative differential output |
| AVDD | B1 | 13 | P | Analog supply (must be the same as PVDDR and PVDDL) |
| AGND | B4 | 3 | P | Analog ground (all GND pins need to be connected) |
| PVDDR | C1 | 11, 12 | P | Right channel power supply (must be the same as AVDD and PVDDL) |
| PGND | C3 | 8 | P | Power ground (all GND pins need to be connected) |
| PVDDL | C4 | 4, 5 | P | Left channel power supply (must be the same as AVDD and PVDDR) |

7 Specifications

7.1 Absolute Maximum Ratings

over operating free-air temperature range (unless otherwise noted).⁽¹⁾

| | | | MIN | MAX | UNIT |
|-------------------|------------------------------------|-----------------------------|-----------------------------------------|-----------------------|------|
| V _{DD} | Supply voltage | AVDD, PVDDR, PVDDL | -0.3 | 6 | V |
| | Input voltage | SDZ, INR+, INR-, INL+, INL- | -0.3 | V _{DD} + 0.3 | V |
| | | SDA, SCL | -0.3 | 6 | |
| | Continuous total power dissipation | | See Dissipation Ratings | | |
| T _A | Operating free-air temperature | | -40 | 85 | °C |
| T _J | Operating junction temperature | | -40 | 150 | °C |
| R _{LOAD} | Minimum load resistance | | | 3.2 | Ω |
| T _{stg} | Storage temperature | | -65 | 150 | °C |

- (1) Stresses beyond those listed under *Absolute Maximum Ratings* may cause permanent damage to the device. These are stress ratings only, which do not imply functional operation of the device at these or any other conditions beyond those indicated under *Recommended Operating Conditions*. Exposure to absolute-maximum-rated conditions for extended periods may affect device reliability.

7.2 ESD Ratings

| | | | VALUE | UNIT |
|--------------------|-------------------------|--------------------------------------------------------------------------------|-------|------|
| V _(ESD) | Electrostatic discharge | Human-body model (HBM), per ANSI/ESDA/JEDEC JS-001 ⁽¹⁾ | ±2000 | V |
| | | Charged-device model (CDM), per JEDEC specification JESD22-C101 ⁽²⁾ | ±500 | |

- (1) JEDEC document JEP155 states that 500-V HBM allows safe manufacturing with a standard ESD control process.
(2) JEDEC document JEP157 states that 250-V CDM allows safe manufacturing with a standard ESD control process.

7.3 Recommended Operating Conditions

| | | | MIN | MAX | UNIT |
|-----------------|--------------------------------|--------------------|-----|-----|------|
| V _{DD} | Supply voltage | AVDD, PVDDR, PVDDL | 2.5 | 5.5 | V |
| V _{IH} | High-level input voltage | SDZ, SDA, SCL | 1.3 | | V |
| V _{IL} | Low-level input voltage | SDZ, SDA, SCL | | 0.6 | V |
| T _A | Operating free-air temperature | | -40 | +85 | °C |

7.4 Thermal Information

| THERMAL METRIC ⁽¹⁾ | TPA2016D2 | | UNIT |
|-------------------------------|----------------------------------------------|-----------|------|
| | YZH (DSBGA) | RTJ (QFN) | |
| | 16 PINS | 20 PINS | |
| R _{θJA} | Junction-to-ambient thermal resistance | | °C/W |
| R _{θJC(top)} | Junction-to-case (top) thermal resistance | | °C/W |
| R _{θJB} | Junction-to-board thermal resistance | | °C/W |
| ψ _{JT} | Junction-to-top characterization parameter | | °C/W |
| ψ _{JB} | Junction-to-board characterization parameter | | °C/W |
| R _{θJC(bot)} | Junction-to-case (bottom) thermal resistance | | °C/W |

- (1) For more information about traditional and new thermal metrics, see the *Semiconductor and IC Package Thermal Metrics* application report, [SPRA953](#).

7.5 Electrical Characteristics

 at $T_A = 25^\circ\text{C}$, $V_{DD} = 3.6\text{ V}$, $SDZ = 1.3\text{ V}$, and $R_L = 8\ \Omega + 33\ \mu\text{H}$ (unless otherwise noted).

| PARAMETER | | TEST CONDITIONS | MIN | TYP | MAX | UNIT |
|-------------|-------------------------------------|------------------------------------------------------------------------------------------------------------------|------|-----|-----|---------------|
| V_{DD} | Supply voltage range | | 2.5 | 3.6 | 5.5 | V |
| I_{SDZ} | Shutdown quiescent current | $SDZ = 0.35\text{ V}$, $V_{DD} = 2.5\text{ V}$ | | 0.1 | 1 | μA |
| | | $SDZ = 0.35\text{ V}$, $V_{DD} = 3.6\text{ V}$ | | 0.2 | 1 | |
| | | $SDZ = 0.35\text{ V}$, $V_{DD} = 5.5\text{ V}$ | | 0.3 | 1 | |
| I_{SWS} | Software shutdown quiescent current | $SDZ = 1.3\text{ V}$, $V_{DD} = 2.5\text{ V}$ | | 35 | 50 | μA |
| | | $SDZ = 1.3\text{ V}$, $V_{DD} = 3.6\text{ V}$ | | 50 | 70 | |
| | | $SDZ = 1.3\text{ V}$, $V_{DD} = 5.5\text{ V}$ | | 75 | 110 | |
| I_{DD} | Supply current | $V_{DD} = 2.5\text{ V}$ | | 3.5 | 4.5 | mA |
| | | $V_{DD} = 3.6\text{ V}$ | | 3.7 | 4.7 | |
| | | $V_{DD} = 5.5\text{ V}$ | | 4.5 | 5.5 | |
| f_{SW} | Class D Switching Frequency | | 275 | 300 | 325 | kHz |
| I_{IH} | High-level input current | $V_{DD} = 5.5\text{ V}$, $SDZ = 5.8\text{ V}$ | | | 1 | μA |
| I_{IL} | Low-level input current | $V_{DD} = 5.5\text{ V}$, $SDZ = -0.3\text{ V}$ | -1 | | | μA |
| t_{START} | Start-up time | $2.5\text{ V} \leq V_{DD} \leq 5.5\text{ V}$ no pop, $C_{IN} \leq 1\ \mu\text{F}$ | | 5 | | ms |
| POR | Power on reset ON threshold | | | 2 | 2.3 | V |
| POR | Power on reset hysteresis | | | 0.2 | | V |
| CMRR | Input common mode rejection | $R_L = 8\ \Omega$, $V_{icm} = 0.5\text{ V}$ and $V_{icm} = V_{DD} - 0.8\text{ V}$, differential inputs shorted | | -70 | | dB |
| V_{oo} | Output offset voltage | $V_{DD} = 3.6\text{ V}$, $A_V = 6\text{ dB}$, $R_L = 8\ \Omega$, inputs AC-grounded | -10 | 2 | 10 | mV |
| Z_{OUT} | Output Impedance in shutdown mode | $SDZ = 0.35\text{ V}$ | | 2 | | k Ω |
| | Gain accuracy | Compression and limiter disabled, Gain = 0 to 30 dB | -0.5 | | 0.5 | dB |
| PSRR | Power supply rejection ratio | $V_{DD} = 2.5\text{ V}$ to 4.7 V | | -80 | | dB |

7.6 I²C Timing Requirements

 For I²C Interface Signals Over Recommended Operating Conditions (unless otherwise noted)

| | | MIN | TYP | MAX | UNIT |
|-------------|------------------------------------------------|----------------|-----|-----|---------------|
| f_{SCL} | Frequency, SCL | No wait states | | 400 | kHz |
| $t_{W(H)}$ | Pulse duration, SCL high | 0.6 | | | μs |
| $t_{W(L)}$ | Pulse duration, SCL low | 1.3 | | | μs |
| $t_{SU(1)}$ | Setup time, SDA to SCL | 100 | | | ns |
| t_{h1} | Hold time, SCL to SDA | 10 | | | ns |
| $t_{(buf)}$ | Bus free time between stop and start condition | 1.3 | | | μs |
| t_{SU2} | Setup time, SCL to start condition | 0.6 | | | μs |
| t_{h2} | Hold time, start condition to SCL | 0.6 | | | μs |
| t_{SU3} | Setup time, SCL to stop condition | 0.6 | | | μs |

7.7 Dissipation Ratings

| PACKAGE ⁽¹⁾ | $T_A \leq 25^\circ\text{C}$ | DERATING FACTOR | $T_A = 70^\circ\text{C}$ | $T_A = 85^\circ\text{C}$ |
|------------------------|-----------------------------|---------------------------|--------------------------|--------------------------|
| 16-ball DSBGA | 1.25 W | 10 mW/ $^\circ\text{C}$ | 0.8 W | 0.65 W |
| 20-pin QFN | 5.2 W | 41.6 mW/ $^\circ\text{C}$ | 3.12 W | 2.7 W |

(1) Dissipations ratings are for a 2-side, 2-plane PCB.

7.8 Operating Characteristics

at $T_A = 25^\circ\text{C}$, $V_{DD} = 3.6\text{V}$, $SDZ = 1.3\text{V}$, $R_L = 8\ \Omega + 33\ \mu\text{H}$, and $A_v = 6\text{ dB}$ (unless otherwise noted).

| | | | MIN | TYP | MAX | UNIT |
|---------------|-------------------------------------|---------------------------------------------------------------------------------|-----|------|-------|---------------|
| k_{SVR} | Power-supply ripple rejection ratio | $V_{DD} = 3.6\text{ Vdc}$ with ac of 200 mV_{PP} at 217 Hz | | -68 | | dB |
| THD+N | Total harmonic distortion + noise | $f_{aud_in} = 1\text{ kHz}$; $P_O = 550\text{ mW}$; $V_{DD} = 3.6\text{ V}$ | | 0.1% | | |
| | | $f_{aud_in} = 1\text{ kHz}$; $P_O = 1\text{ W}$; $V_{DD} = 5\text{ V}$ | | 0.1% | | |
| | | $f_{aud_in} = 1\text{ kHz}$; $P_O = 630\text{ mW}$; $V_{DD} = 3.6\text{ V}$ | | 1% | | |
| | | $f_{aud_in} = 1\text{ kHz}$; $P_O = 1.4\text{ W}$; $V_{DD} = 5\text{ V}$ | | 1% | | |
| $Nf_{o_{nF}}$ | Output integrated noise | $A_v = 6\text{ dB}$ | | 44 | | μV |
| Nf_{o_A} | Output integrated noise | $A_v = 6\text{ dB floor}$, A-weighted | | 33 | | μV |
| FR | Frequency response | $A_v = 6\text{ dB}$ | 20 | | 20000 | Hz |
| $P_{O_{max}}$ | Maximum output power | THD+N = 10%, $V_{DD} = 5\text{ V}$, $R_L = 8\ \Omega$ | | 1.72 | | W |
| | | THD+N = 10%, $V_{DD} = 3.6\text{ V}$, $R_L = 8\ \Omega$ | | 750 | | mW |
| | | THD+N = 10%, $V_{DD} = 5\text{ V}$, $R_L = 4\ \Omega$ | | 2.8 | | W |
| | | THD+N = 10%, $V_{DD} = 3.6\text{ V}$, $R_L = 4\ \Omega$ | | 1.5 | | mW |
| η | Efficiency | THD+N = 1%, $V_{DD} = 3.6\text{ V}$, $R_L = 8\ \Omega$, $P_O = 0.63\text{ W}$ | | 90% | | |
| | | THD+N = 1%, $V_{DD} = 5\text{ V}$, $R_L = 8\ \Omega$, $P_O = 1.4\text{ W}$ | | 90% | | |

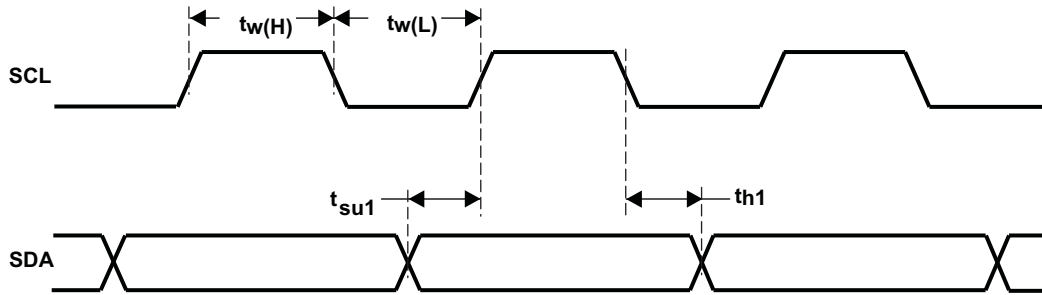

Figure 1. SCL and SDA Timing

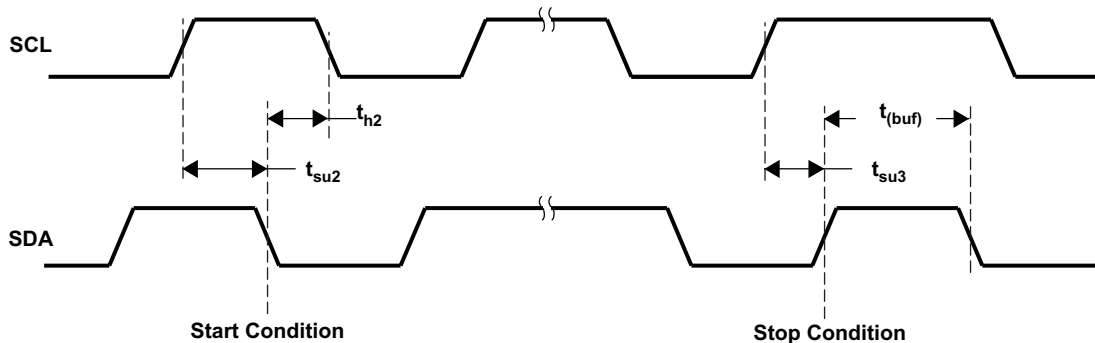

Figure 2. Start and Stop Conditions Timing

7.9 Typical Characteristics

with $C_{(DECOUPLE)} = 1 \mu\text{F}$, $C_I = 1 \mu\text{F}$.

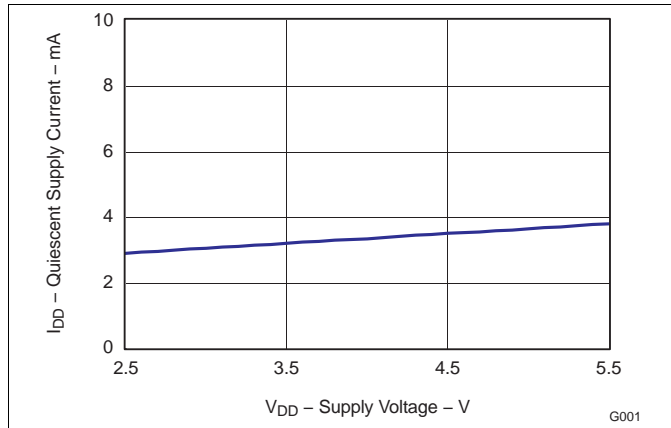

Figure 3. Quiescent Supply Current vs Supply Voltage

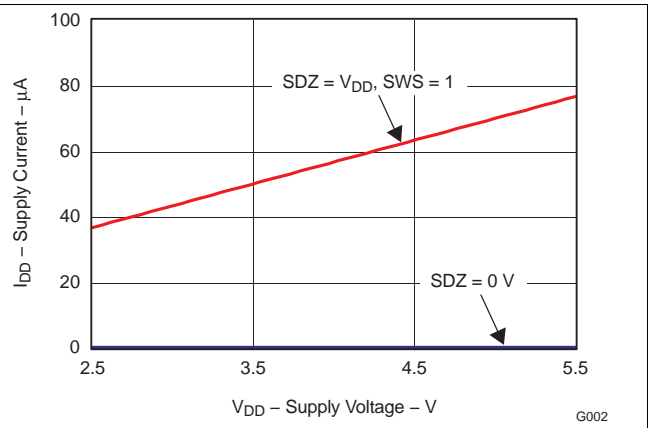

Figure 4. Supply Current vs Supply Voltage in Shutdown

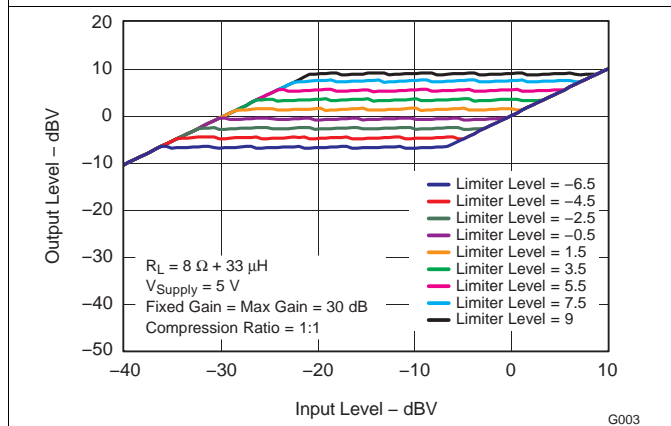

Figure 5. Output Level vs Input Level With Limiter Enabled

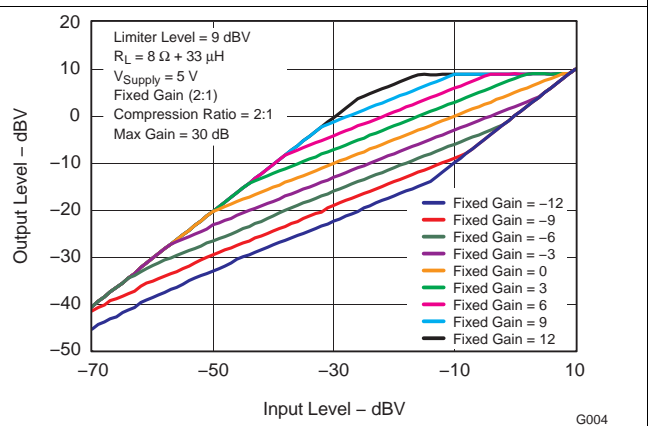

Figure 6. Output Level vs Input Level With 2:1 Compression

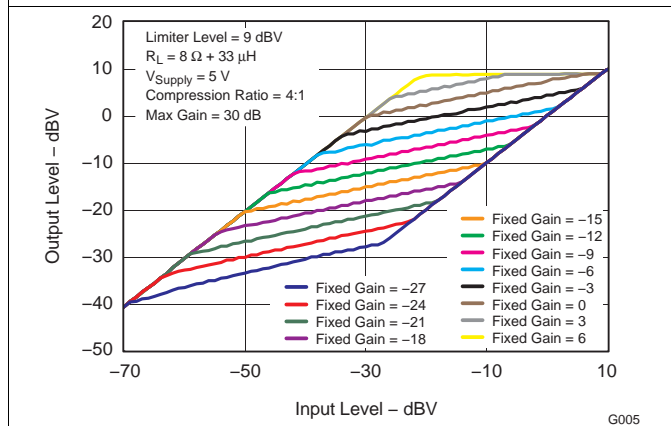

Figure 7. Output Level vs Input Level With 4:1 Compression

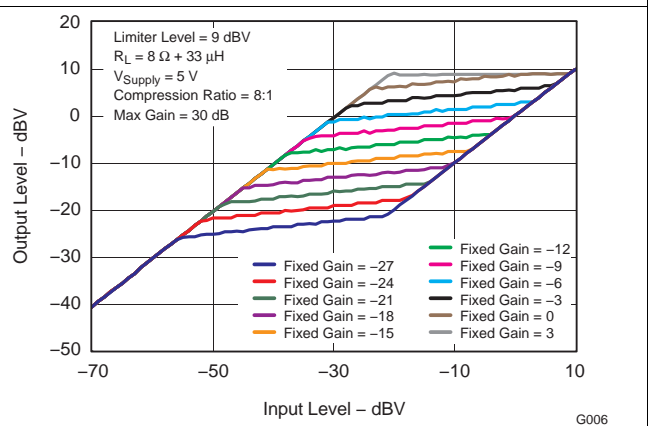

Figure 8. Output Level vs Input Level With 8:1 Compression

Typical Characteristics (continued)

with $C_{(DECOUPLE)} = 1 \mu\text{F}$, $C_1 = 1 \mu\text{F}$.

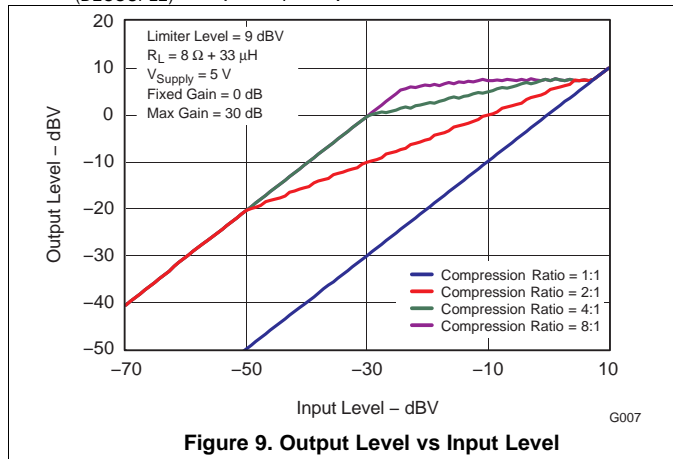

Figure 9. Output Level vs Input Level

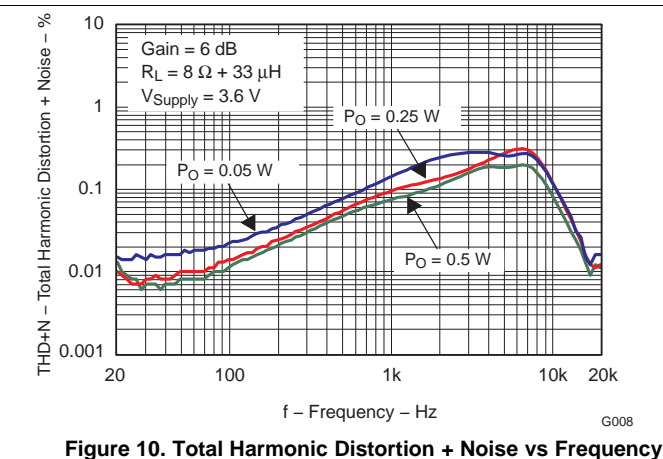

Figure 10. Total Harmonic Distortion + Noise vs Frequency

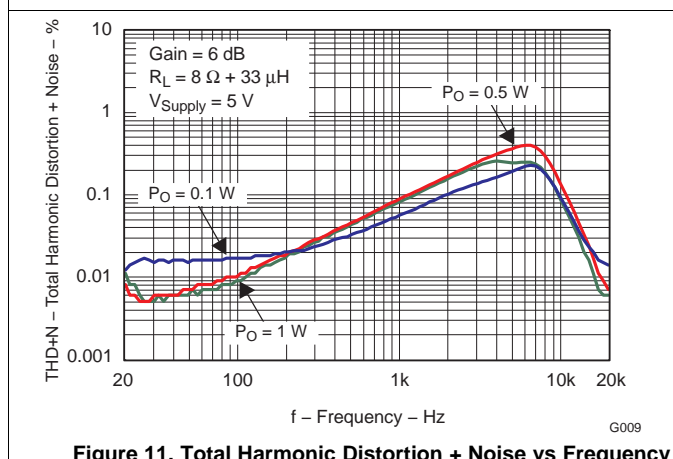

Figure 11. Total Harmonic Distortion + Noise vs Frequency

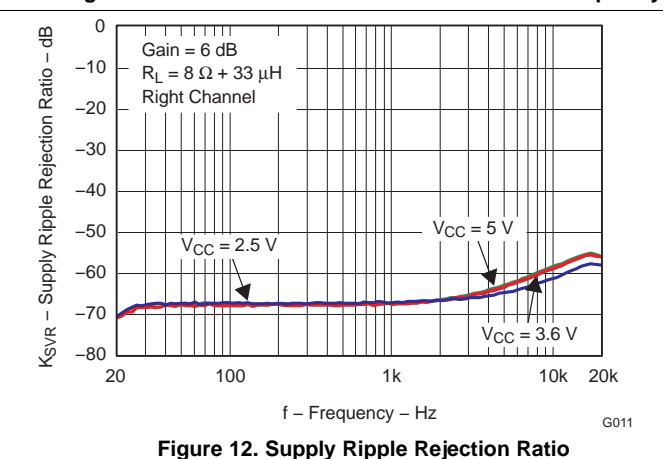

Figure 12. Supply Ripple Rejection Ratio

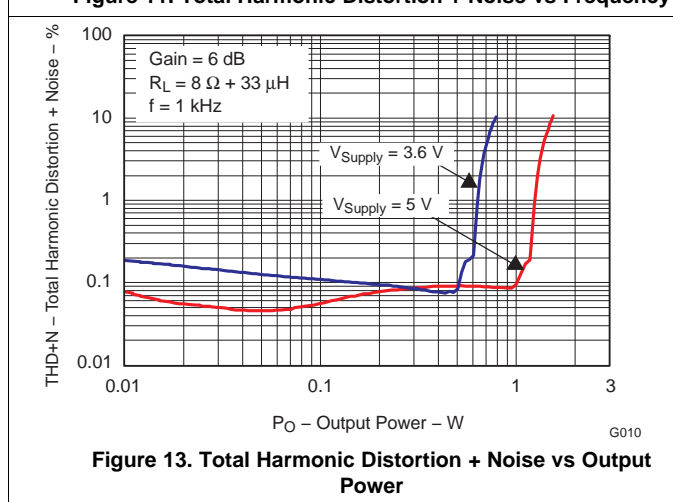

Figure 13. Total Harmonic Distortion + Noise vs Output Power

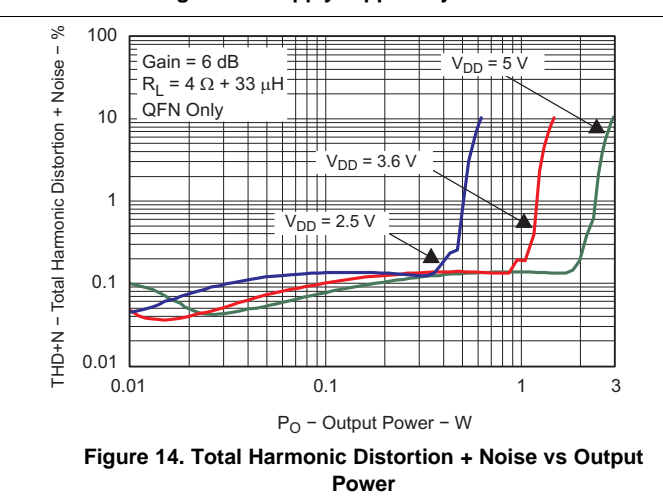
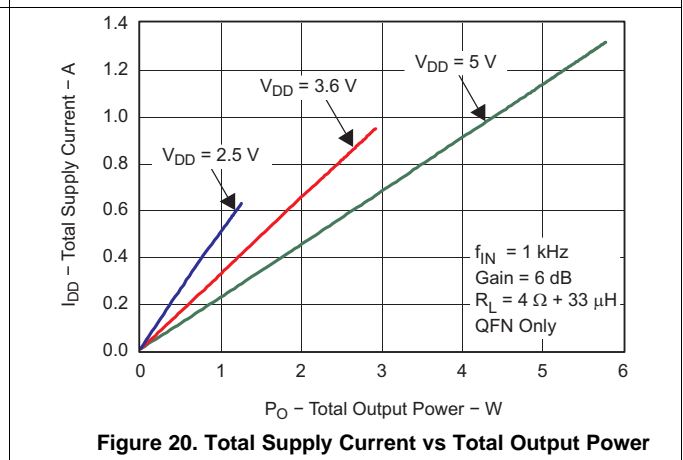
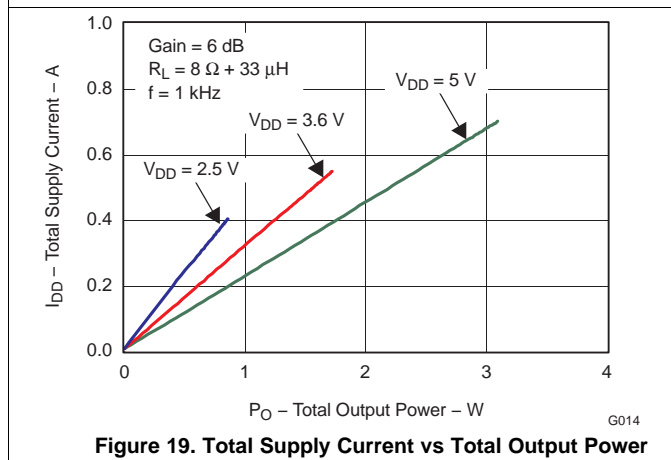
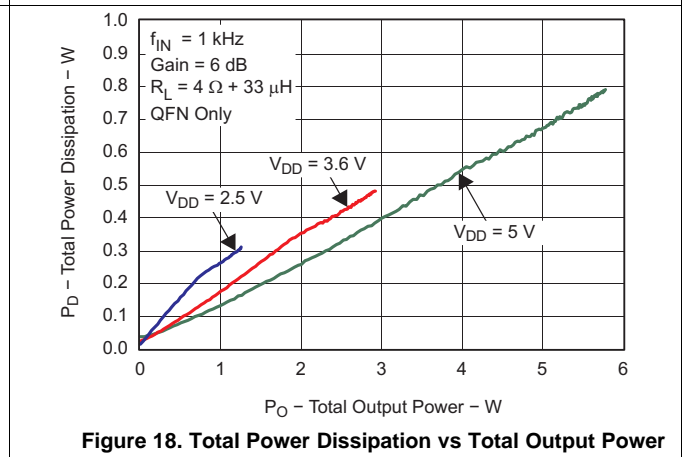
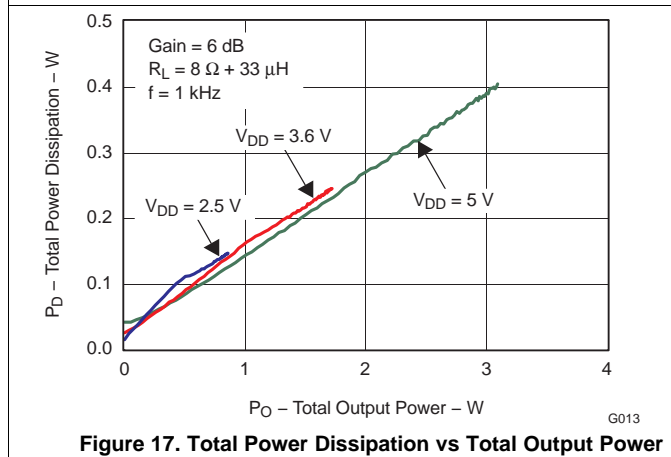
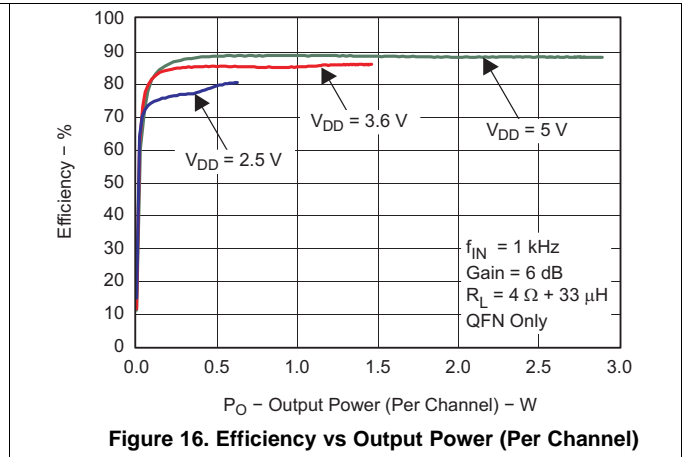
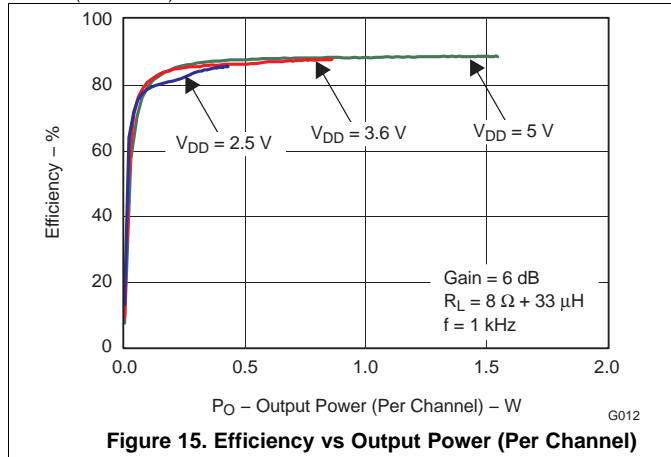

Figure 14. Total Harmonic Distortion + Noise vs Output Power

Typical Characteristics (continued)

with $C_{(DECOUPLE)} = 1 \mu\text{F}$, $C_1 = 1 \mu\text{F}$.



Typical Characteristics (continued)

with $C_{(DECOUPLE)} = 1 \mu\text{F}$, $C_1 = 1 \mu\text{F}$.

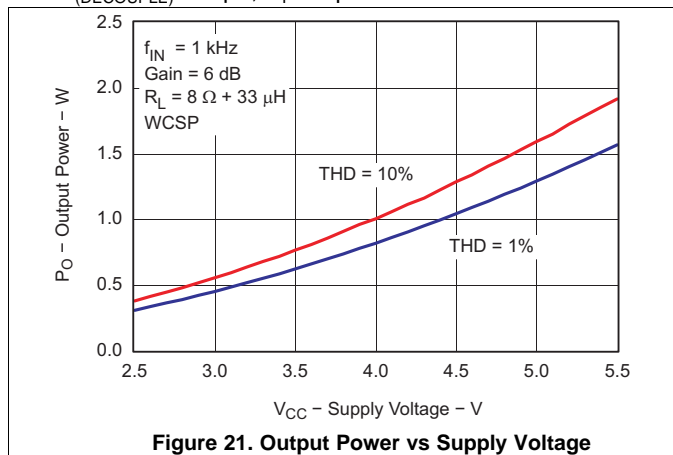

Figure 21. Output Power vs Supply Voltage

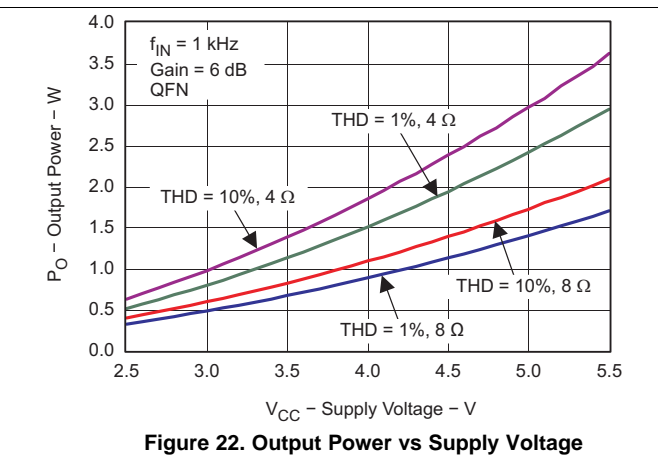

Figure 22. Output Power vs Supply Voltage

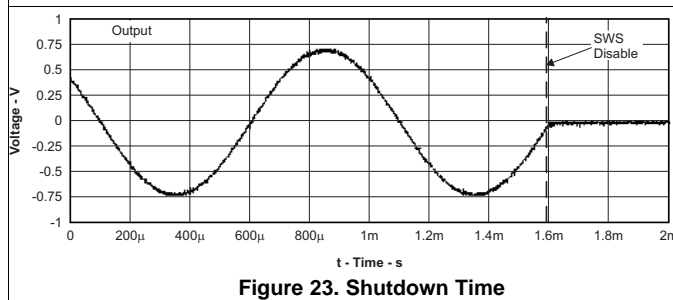

Figure 23. Shutdown Time

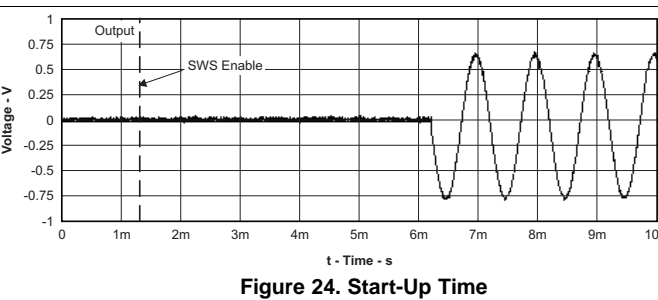
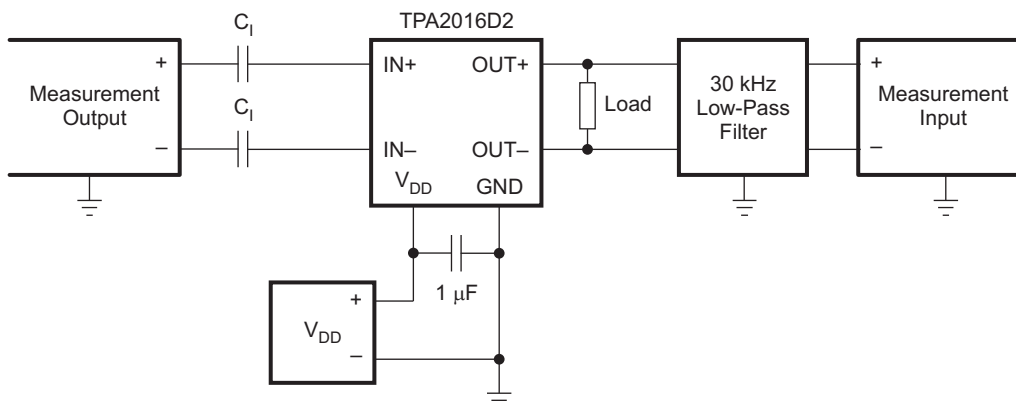

Figure 24. Start-Up Time

8 Parameter Measurement Information

All parameters are measured according to the conditions described in [Specifications](#). Figure 25 shows the setup used for the typical characteristics of the test device.



- (1) All measurements were taken with a 1- μF C_1 (unless otherwise noted.)
- (2) A 33- μH inductor was placed in series with the load resistor to emulate a small speaker for efficiency measurements.
- (3) The 30-kHz low-pass filter is required, even if the analyzer has an internal low-pass filter. An RC low-pass filter (1 k Ω 4.7 nF) is used on each output for the data sheet graphs.
- (4) All THD + N graphs are taken with outputs out of phase (unless otherwise noted). All data is taken on left channel.
- (5) All data is taken on the DSBGA package unless otherwise noted.

Figure 25. Test Setup for Graphs

9 Detailed Description

9.1 Overview

The TPA2016D2 is a stereo Class-D audio power amplifier capable of driving 1.7 W/Ch at 5 V or 750 mW/Ch at 3.6 V into 8-Ω load, and 2.8 W/Ch at 5 V or 1.5 W/Ch at 3.6 V into 4-Ω load. The device features independent software shutdown controls for each channel and also provides thermal and short-circuit protection. In addition to these features, a fast start-up time and small package size make the TPA2016D2 an ideal choice for cellular handsets, PDAs, and other portable applications.

9.2 Functional Block Diagram

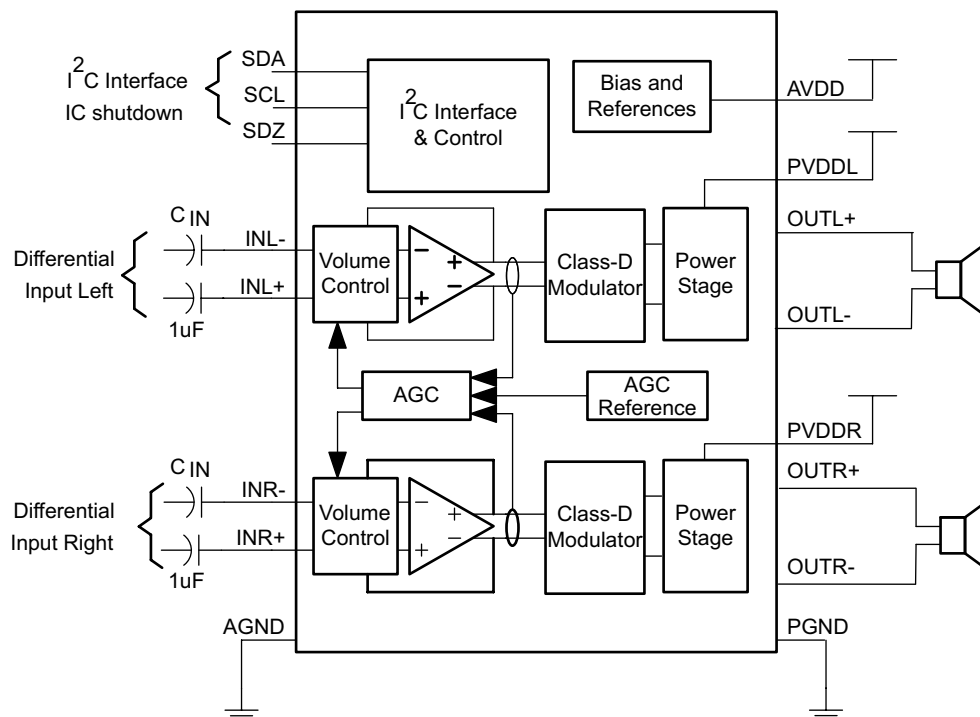

Copyright © 2016, Texas Instruments Incorporated

9.3 Feature Description

9.3.1 Operation With DACs and CODECs

In using Class-D amplifiers with CODECs and DACs, sometimes there is an increase in the output noise floor from the audio amplifier. This occurs when mixing of the output frequencies of the CODEC/DAC mix with the switching frequencies of the audio amplifier input stage. The noise increase can be solved by placing a lowpass filter between the CODEC/DAC and audio amplifier. This filters off the high frequencies that cause the problem and allow proper performance (see [Functional Block Diagram](#)).

If driving the TPA2016D2 input with 4th-order or higher $\Delta\Sigma$ DACs or CODECs, add an RC lowpass filter at each of the audio inputs (IN+ and IN-) of the TPA2016D2 to ensure best performance. The recommended resistor value is 100 Ω and the capacitor value of 47 nF.

9.3.2 Filter-Free Operation and Ferrite Bead Filters

A ferrite bead filter can often be used if the design is failing radiated emissions without an LC filter and the frequency sensitive circuit is greater than 1 MHz. This filter functions well for circuits that just have to pass FCC and CE because FCC and CE only test radiated emissions greater than 30 MHz. When choosing a ferrite bead, choose one with high impedance at high frequencies, and low impedance at low frequencies. In addition, select a ferrite bead with adequate current rating to prevent distortion of the output signal.

Feature Description (continued)

Use an LC output filter if there are low-frequency (< 1 MHz), EMI-sensitive circuits or there are long leads from amplifier to speaker. Figure 26 shows typical ferrite bead and LC output filters.

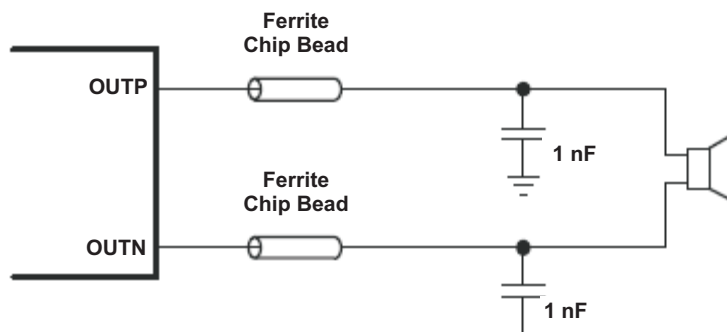

Figure 26. Typical Ferrite Bead Filter (Chip Bead Example: TDK: MPZ1608S221A)

9.3.3 Short-Circuit Protection

TPA2016D2 goes to low duty cycle mode when a short circuit event happens. In order to go to normal duty cycle mode again, it is necessary to reset the device, the shutdown mode can be set through the SDZ pin or software shutdown with the SWS bit. FAULT bit (register 1, bit 3) set to high when short-circuit event happens. It requires a write to clear.

This feature can protect the device without affecting the device's long-term reliability.

9.3.4 Automatic Gain Control

The Automatic Gain Control (AGC) feature provides continuous automatic gain adjustment to the amplifier through an internal PGA. This feature enhances the perceived audio loudness and at the same time prevents speaker damage from occurring (Limiter function).

The AGC function attempts to maintain the audio signal gain as selected by the user through the Fixed Gain, Limiter Level, and Compression Ratio variables. Other advanced features included are Maximum Gain and Noise Gate Threshold. Table 1 describes the function of each variable in the AGC function.

Table 1. TPA2016D2 AGC Variable Descriptions

| VARIABLE | DESCRIPTION |
|----------------------|----------------------------------------------------------------------------------------------------------------------------------------------------------------------------|
| Maximum Gain | The gain at the lower end of the compression region. |
| Fixed Gain | The normal gain of the device when the AGC is inactive. The fixed gain is also the initial gain when the device comes out of shutdown mode or when the AGC is disabled. |
| Limiter Level | The value that sets the maximum allowed output amplitude. |
| Compression Ratio | The relation between input and output voltage. |
| Noise Gate Threshold | Below this value, the AGC holds the gain to prevent breathing effects. |
| Attack Time | The minimum time between two gain decrements. |
| Release Time | The minimum time between two gain increments. |
| Hold Time | The time it takes for the very first gain increment after the input signal amplitude decreases. |

The AGC works by detecting the audio input envelope. The gain changes depending on the amplitude, the limiter level, the compression ratio, and the attack and release time. The gain changes constantly as the audio signal increases and/or decreases to create the compression effect. The gain step size for the AGC is 0.5 dB. If the audio signal has near-constant amplitude, the gain does not change. Figure 27 shows how the AGC works.

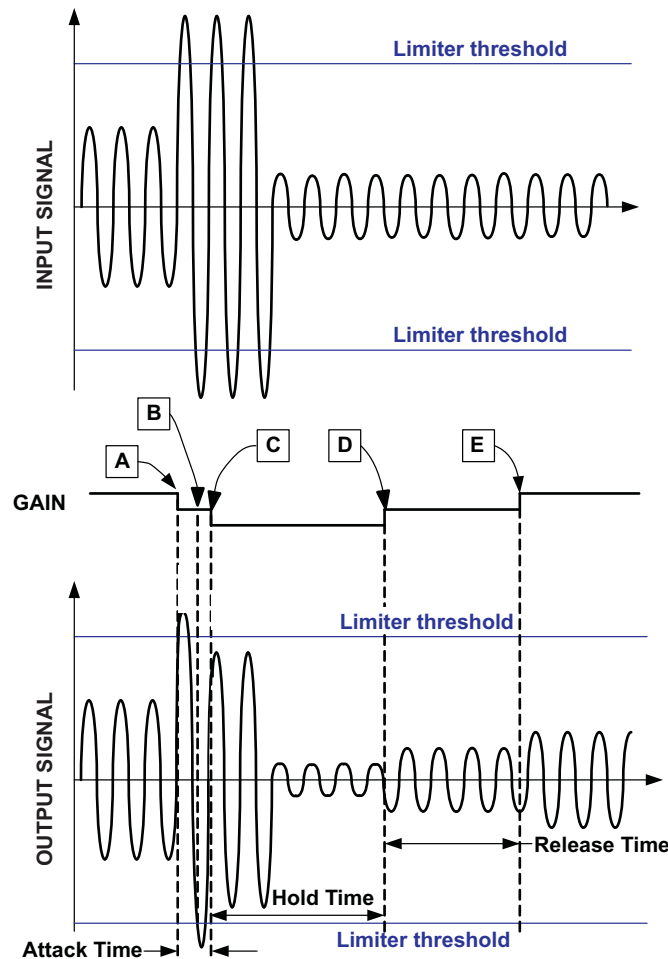

- A. Gain decreases with no delay; attack time is reset. Release time and hold time are reset.
- B. Signal amplitude above limiter level, but gain cannot change because attack time is not over.
- C. Attack time ends; gain is allowed to decrease from this point forward by one step. Gain decreases because the amplitude remains above limiter threshold. All times are reset
- D. Gain increases after release time finishes and signal amplitude remains below desired level. All times are reset after the gain increase.
- E. Gain increases after release time is finished again because signal amplitude remains below desired level. All times are reset after the gain increase.

Figure 27. Input and Output Audio Signal vs Time

Because the number of gain steps is limited the compression region is limited as well. Figure 28 shows how the gain changes versus the input signal amplitude in the compression region.

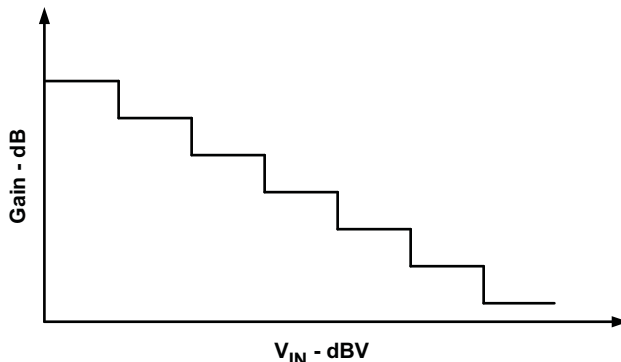

Figure 28. Input Signal Voltage vs Gain

Thus the AGC performs a mapping of the input signal versus the output signal amplitude. This mapping can be modified according to the variables from Table 1.

The following graphs and explanations show the effect of each variable to the AGC independently; consider them when choosing values.

9.3.4.1 Fixed Gain

The fixed gain determines the initial gain of the AGC. Set the gain using the following variables:

- Set the fixed gain to be equal to the gain when the AGC is disabled.
- Set the fixed gain to maximize SNR.
- Set the fixed gain such that it does not overdrive the speaker.

Figure 29 shows how the fixed gain influences the input signal amplitude versus the output signal amplitude state diagram. The dotted 1:1 line is displayed for reference. The 1:1 line means that for a 1-dB increase in the input signal, the output increases by 1 dB.

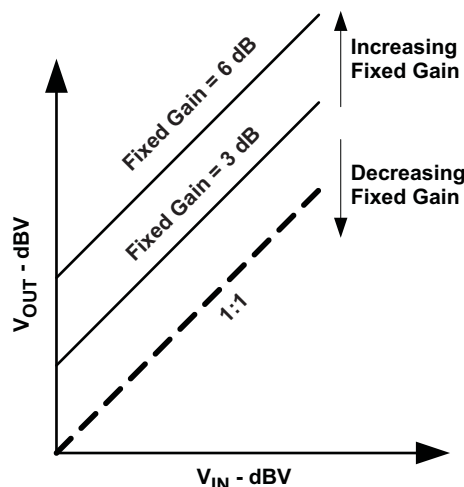

Figure 29. Output Signal vs Input Signal State Diagram Showing Different Fixed Gain Configurations

If the Compression function is enabled, the Fixed Gain is adjustable from –28 dB to 30 dB. If the Compression function is disabled, the Fixed gain is adjustable from 0 dB to 30 dB.

9.3.4.2 Limiter Level

The Limiter level sets the maximum amplitude allowed at the output of the amplifier. The limiter should be set with the following constraints in mind:

- Below or at the maximum power rating of the speaker

- Below the minimum supply voltage in order to avoid clipping

Figure 30 shows how the limiter level influences the input signal amplitude versus the output signal amplitude state diagram.

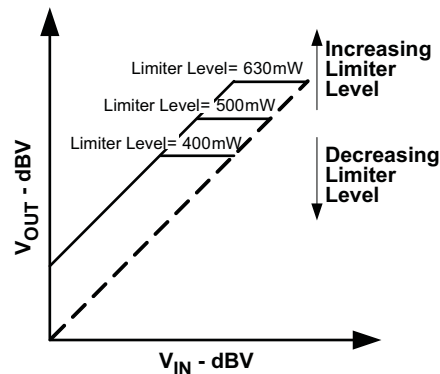

Figure 30. Output Signal vs Input Signal State Diagram Showing Different Limiter Level Configurations

The limiter level and the fixed gain influence each other. If the fixed gain is set high, the AGC has a large limiter range. The fixed gain is set low, the AGC has a short limiter range. Figure 31 illustrates the two examples:

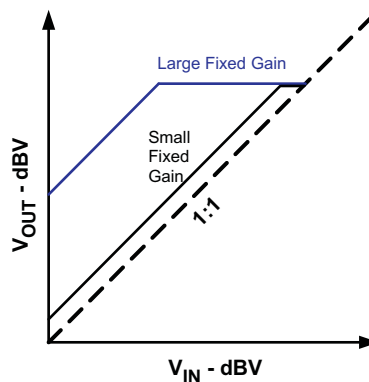

Figure 31. Output Signal vs Input Signal State Diagram Showing Same Limiter Level Configurations With Different Fixed Gain Configurations

9.3.4.3 Compression Ratio

The compression ratio sets the relation between input and output signal outside the limiter level region. The compression ratio compresses the dynamic range of the audio. For example if the audio source has a dynamic range of 60 dB and compression ratio of 2:1 is selected, then the output has a dynamic range of 30 dB. Most small form factor speakers have small dynamic range. Compression ratio allows audio with large dynamic range to fit into a speaker with small dynamic range.

The compression ratio also increases the loudness of the audio without increasing the peak voltage. The higher the compression ratio, the louder the perceived audio.

For example:

- A compression ratio of 4:1 is selected (meaning that a 4-dB change in the input signal results in a 1-dB signal change at the output)
- A fixed gain of 0 dB is selected and the maximum audio level is at 0 dBV.

When the input signal decreases to -32 dBV, the amplifier increases the gain to 24 dB in order to achieve an output of -8 dBV. The output signal amplitude equation is:

$$\text{Output signal amplitude} = \frac{\text{Input signal initial amplitude} - |\text{Current input signal amplitude}|}{\text{Compression ratio}} \quad (1)$$

In this example:

$$-8\text{dBV} = \frac{0\text{dBV} - |-32\text{ dBV}|}{4} \tag{2}$$

The gain change equation is:

$$\text{Gain change} = \left(1 - \frac{1}{\text{Compression ratio}} \right) \times \text{Input signal change} \tag{3}$$

$$24\text{ dB} = \left(1 - \frac{1}{4} \right) \times 32 \tag{4}$$

Consider the following when setting the compression ratio:

- Dynamic range of the speaker
- Fixed gain level
- Limiter Level
- Audio Loudness vs Output Dynamic Range.

Figure 32 shows different settings for dynamic range and different fixed gain selected but no limiter level.

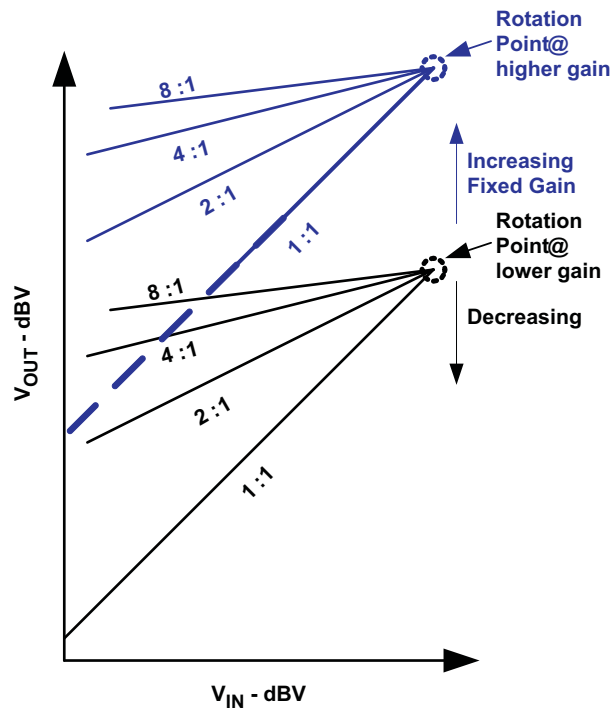

Figure 32. Output Signal vs Input Signal State Diagram Showing Different Compression Ratio Configurations With Different Fixed Gain Configurations

The rotation point is always at $V_{in} = 10\text{ dBV}$. The rotation point is not located at the intersection of the limiter region and the compression region. By changing the fixed gain the rotation point will move in the y-axis direction only, as shown in the previous graph.

9.3.4.4 Interaction Between Compression Ratio and Limiter Range

The compression ratio can be limited by the limiter range. Note that the limiter range is selected by the limiter level and the fixed gain.

For a setting with large limiter range, the amount of gain steps in the AGC remaining to perform compression are limited. Figure 33 shows two examples, where the fixed gain was changed.

1. Small limiter range yielding a large compression region (small fixed gain).
2. Large limiter range yielding a small compression region (large fixed gain).

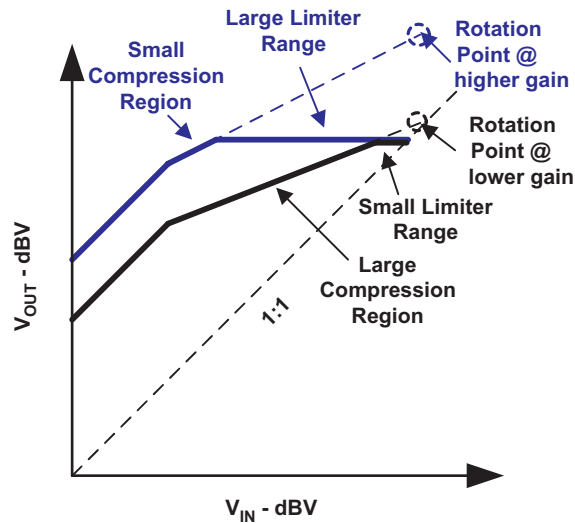

Figure 33. Output Signal vs Input Signal State Diagram Showing the Effects of the Limiter Range to the Compression Region

9.3.4.5 Noise Gate Threshold

The noise gate threshold prevents the AGC from changing the gain when there is no audio at the input of the amplifier. The noise gate threshold stops gain changes until the input signal is above the noise gate threshold. Select the noise gate threshold to be above the noise but below the minimum audio at the input of the amplifier signal. A filter is needed between delta-sigma CODEC/DAC and TPA2016D2 for effectiveness of the noise gate function. The filter eliminates the out-of-band noise from delta-sigma modulation and keeps the CODEC/DAC output noise lower than the noise gate threshold.

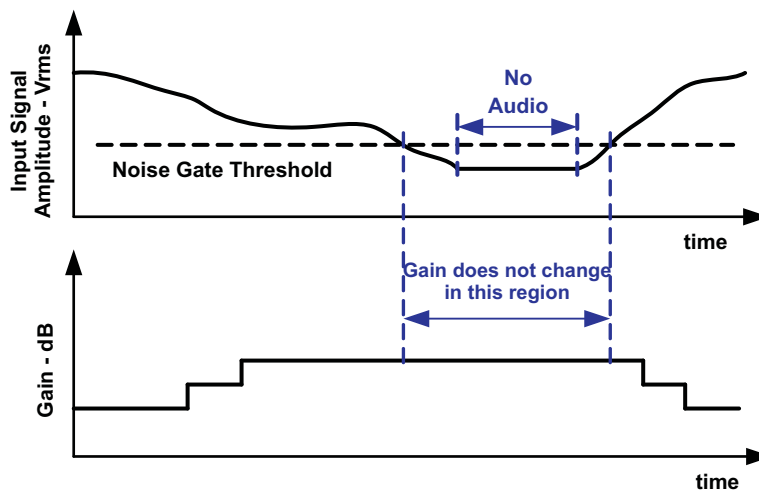

Figure 34. Time Diagram Showing the Relationship Between Input Signal Amplitude, Noise Gate Threshold and Gain Versus Time

9.3.4.6 Maximum Gain

This variable limits the number of gain steps in the AGC. This feature is useful in order to accomplish a more advanced output signal vs input signal transfer characteristic.

For example, to prevent the gain from going above a certain value, reduce the maximum gain.

However, this variable will affect the limiter range and the compression region. If the maximum gain is decreased, the limiter range and compression region is reduced. Figure 35 illustrates the effects.

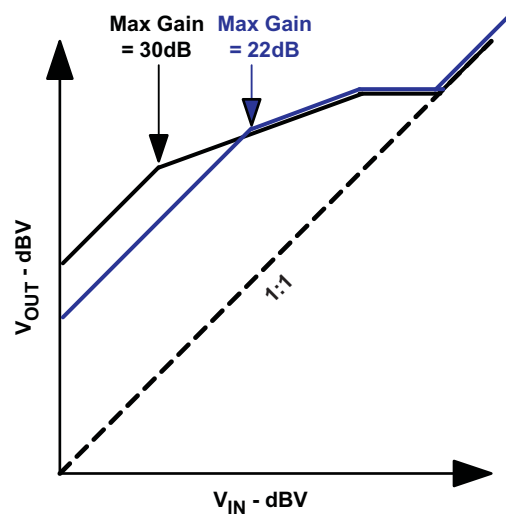

Figure 35. Output Signal vs Input Signal State Diagram Showing Different Maximum Gains

A particular application requiring maximum gain of 22 dB, for example. Thus, set the maximum gain at 22 dB. The amplifier gain will never have a gain higher than 22 dB; however, this will reduce the limiter range.

9.3.4.7 Attack, Release, and Hold Time

- The attack time is the minimum time between gain decreases.
- The release time is the minimum time between gain increases.
- The hold time is the minimum time between a gain decrease (attack) and a gain increase (release). The hold time can be deactivated. Hold time is only valid if greater than release time.

Successive gain decreases are never faster than the attack time. Successive gain increases are never faster than the release time.

All time variables (attack, release, and hold) start counting after each gain change performed by the AGC. The AGC is allowed to decrease the gain (attack) only after the attack time finishes. The AGC is allowed to increase the gain (release) only after the release time finishes counting. However, if the preceding gain change was an attack (gain increase) and the hold time is enabled and longer than the release time, then the gain is only increased after the hold time.

The hold time is only enabled after a gain decrease (attack). The hold time replaces the release time after a gain decrease (attack). If the gain needs to be increased further, then the release time is used. The release time is used instead of the hold time if the hold time is disabled.

The attack time should be at least 100 times shorter than the release and hold time. The hold time should be the same or greater than the release time. It is important to select reasonable values for those variables in order to prevent the gain from changing too often or too slow.

Figure 36 illustrates the relationship between the three time variables.

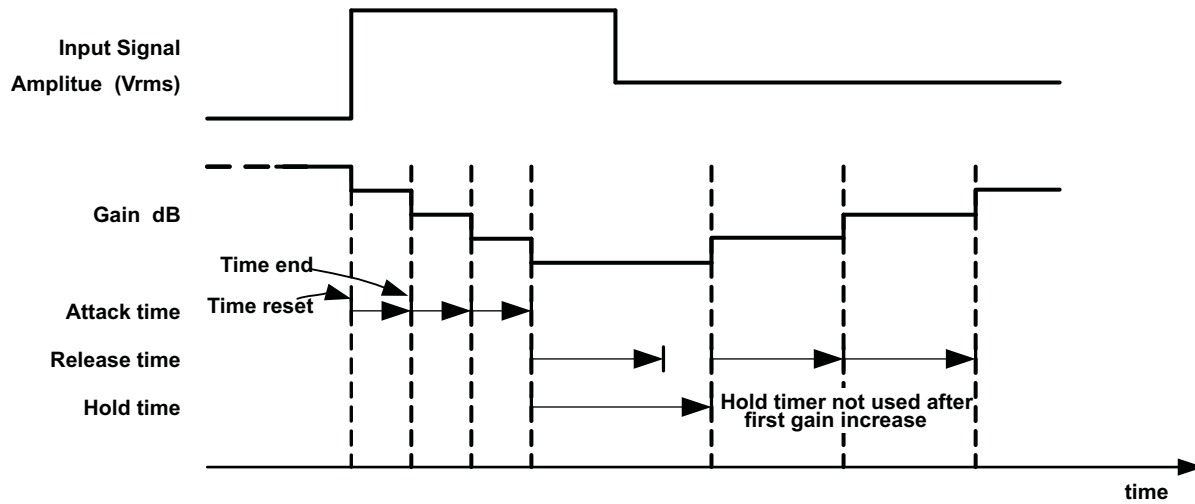

Figure 36. Time Diagram Showing the Relation Between the Attack, Release, and Hold Time vs Input Signal Amplitude and Gain

Figure 37 shows a state diagram of the input signal amplitude vs the output signal amplitude and a summary of how the variables from Table 1 affect them.

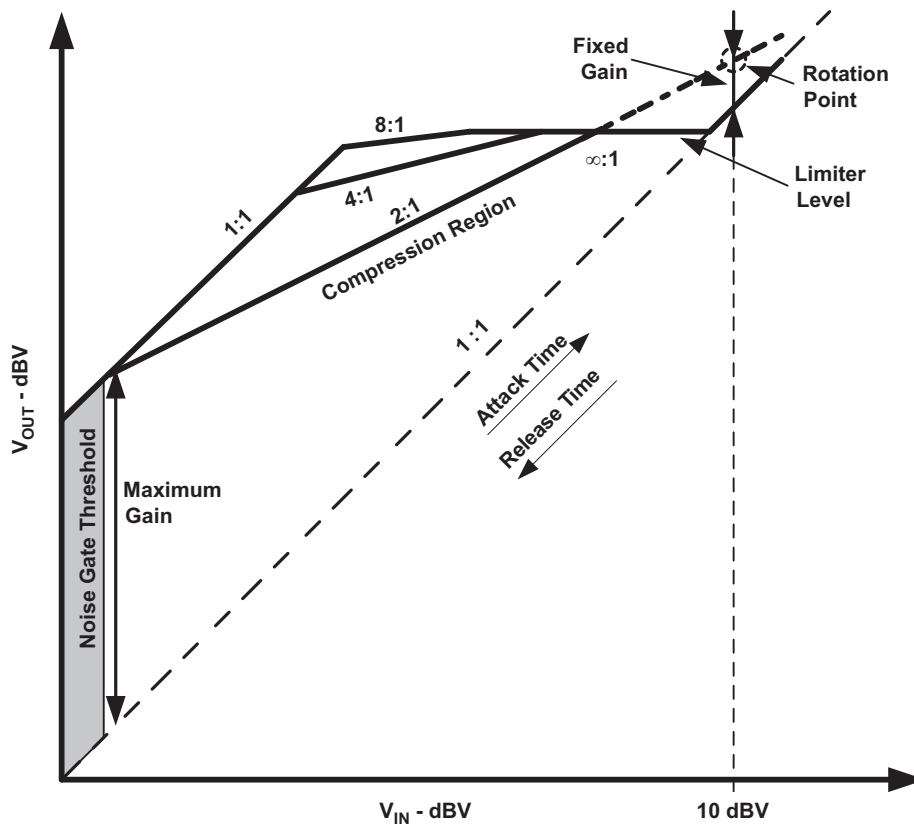

Figure 37. Output Signal vs Input Signal State Diagram

9.4 Device Functional Modes

9.4.1 TPA2016D2 AGC Operation

The TPA2016D2 is controlled by the I²C interface. The correct start-up sequence is:

1. Apply the supply voltage to the AV_{DD} and PV_{DD} (L, R) pins.
2. Apply a voltage above V_{IH} to the SDZ pin. The TPA2016D2 powers up the I²C interface and the control logic. By default, the device is in active mode (SWS = 0). After a few milliseconds the amplifier will enable the class-D output stage and become fully operational.
3. The amplifier starts at a gain of 0 dB and the AGC starts ramping the gain after the input signal exceeds the noise gate threshold.

CAUTION

Do not interrupt the start-up sequence after changing SDZ from V_{IL} to V_{IH}.
Do not interrupt the start-up sequence after changing SWS from 1 to 0.

The default conditions of TPA2016D2 allows audio playback without I²C control. See [Table 4](#) for entire default conditions.

There are several options to disable the amplifier:

- Write SPK_EN_R = 0 and SPK_EN_L = 0 to the register (0x01, 6 and 0x01, 7). This write disables each speaker amplifier, but leaves all other circuits operating.
- Write SWS = 1 to the register (0x01, 5). This action disables most of the amplifier functions.
- Apply V_{IL} to SDZ. This action shuts down all the circuits and has very low quiescent current consumption. This action resets the registers to its default values.

CAUTION

Do not interrupt the shutdown sequence after changing SDZ from V_{IH} to V_{IL}.
Do not interrupt the shutdown sequence after changing SWS from 0 to 1.

9.4.2 TPA2016D2 AGC Recommended Settings

Table 2. Recommended AGC Settings for Different Types of Audio Source (V_{DD} = 3.6 V)

| AUDIO SOURCE | COMPRESSION RATIO | ATTACK TIME (ms/6 dB) | RELEASE TIME (ms/6 dB) | HOLD TIME (ms) | FIXED GAIN (dB) | LIMITER LEVEL (dBV) |
|---------------|-------------------|-----------------------|------------------------|----------------|-----------------|---------------------|
| Pop Music | 4:1 | 1.28 to 3.84 | 986 to 1640 | 137 | 6 | 7.5 |
| Classical | 2:1 | 2.56 | 1150 | 137 | 6 | 8 |
| Jazz | 2:1 | 5.12 to 10.2 | 3288 | — | 6 | 8 |
| Rap / Hip Hop | 4:1 | 1.28 to 3.84 | 1640 | — | 6 | 7.5 |
| Rock | 2:1 | 3.84 | 4110 | — | 6 | 8 |
| Voice / News | 4:1 | 2.56 | 1640 | — | 6 | 8.5 |

9.5 Programming

9.5.1 General I²C Operation

The I²C bus employs two signals, SDA (data) and SCL (clock), to communicate between integrated circuits in a system. The bus transfers data serially one bit at a time. The address and data 8-bit bytes are transferred most significant bit (MSB) first. In addition, each byte transferred on the bus is acknowledged by the receiving device with an *acknowledge* bit. Each transfer operation begins with the master device driving a start condition on the bus and ends with the master device driving a stop condition on the bus. The bus uses transitions on the data terminal (SDA) while the clock is at logic high to indicate start and stop conditions. A high-to-low transition on

Programming (continued)

SDA indicates a start and a low-to-high transition indicates a stop. Normal data-bit transitions must occur within the low time of the clock period. Figure 38 shows a typical sequence. The master generates the 7-bit slave address and the read/write (R/W) bit to open communication with another device, and then waits for an acknowledge condition. The TPA2016D2 holds SDA low during the acknowledge clock period to indicate acknowledgment. When this acknowledgment occurs, the master transmits the next byte of the sequence. Each device is addressed by a unique 7-bit slave address plus R/W bit (1 byte). All compatible devices share the same signals via a bidirectional bus using a wired-AND connection.

An external pullup resistor must be used for the SDA and SCL signals to set the logic high level for the bus. When the bus level is 5 V, use pullup resistors between 1 kΩ and 2 kΩ.

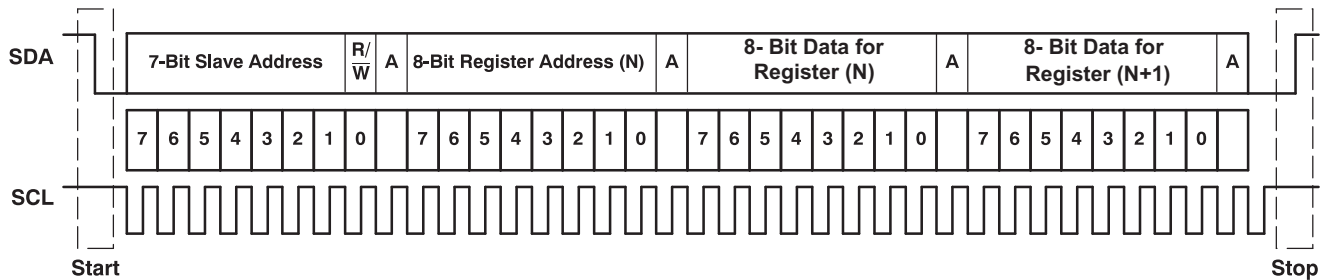

Figure 38. Typical I²C Sequence

There is no limit on the number of bytes that can be transmitted between start and stop conditions. When the last word transfers, the master generates a stop condition to release the bus. A generic data transfer sequence is shown in Figure 38.

9.5.2 Single- and Multiple-Byte Transfers

The serial control interface supports both single-byte and multi-byte read or write operations for all registers.

During multiple-byte read operations, the TPA2016D2 responds with data, one byte at a time, starting at the register assigned, as long as the master device continues to respond with acknowledgments.

The TPA2016D2 supports sequential I²C addressing. For write transactions, if a register is issued followed by data for that register and all the remaining registers that follow, a sequential I²C write transaction has occurred. For I²C sequential write transactions, the register issued then serves as the starting point, and the amount of data subsequently transmitted, before a stop or start is transmitted, determines the number of registers written.

9.5.3 Single-Byte Write

As Figure 39 shows, a single-byte data write transfer begins with the master device transmitting a start condition followed by the I²C device address and the read or write bit. The read or write bit determines the direction of the data transfer. For a write data transfer, the read/write bit must be set to '0'. After receiving the correct I²C device address and the read/write bit, the TPA2016D2 responds with an acknowledge bit. Next, the master transmits the register byte corresponding to the TPA2016D2 internal memory address being accessed. After receiving the register byte, the TPA2016D2 again responds with an acknowledge bit. Next, the master device transmits the data byte to be written to the memory address being accessed. After receiving the register byte, the TPA2016D2 again responds with an acknowledge bit. Finally, the master device transmits a stop condition to complete the single-byte data write transfer.

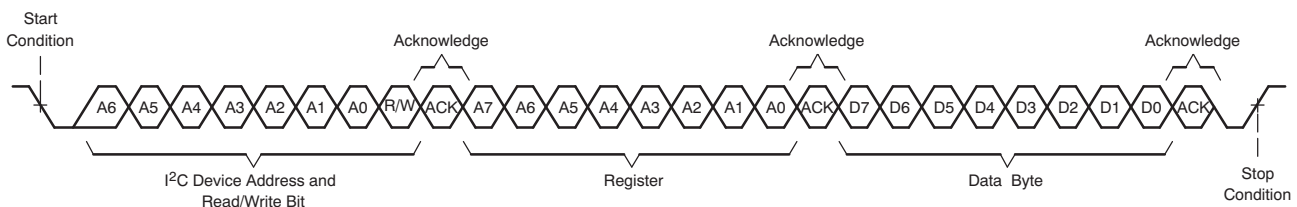

Figure 39. Single-Byte Write Transfer

Programming (continued)

9.5.4 Multiple-Byte Write and Incremental Multiple-Byte Write

A multiple-byte data write transfer is identical to a single-byte data write transfer except that multiple data bytes are transmitted by the master device to the TPA2016D2 as shown in Figure 40. After receiving each data byte, the TPA2016D2 responds with an acknowledge bit.

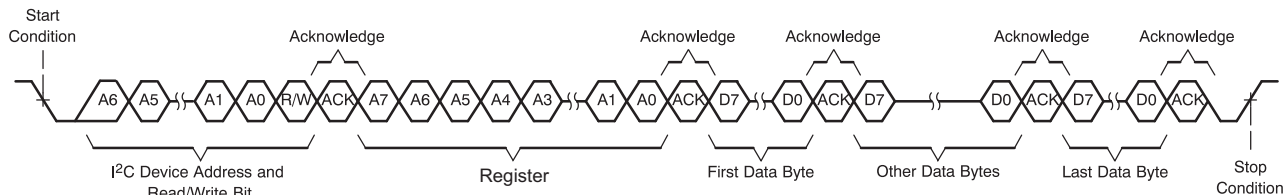

Figure 40. Multiple-Byte Write Transfer

9.5.5 Single-Byte Read

As Figure 41 shows, a single-byte data read transfer begins with the master device transmitting a start condition followed by the I2C device address and the read or write bit. For the data read transfer, both a write followed by a read are actually executed. Initially, a write is executed to transfer the address byte of the internal memory address to be read. As a result, the read or write bit is set to a 0.

After receiving the TPA2016D2 address and the read or write bit, the TPA2016D2 responds with an acknowledge bit. The master then sends the internal memory address byte, after which the TPA2016D2 issues an acknowledge bit. The master device transmits another start condition followed by the TPA2016D2 address and the read or write bit again. This time the read/write bit is set to 1, indicating a read transfer. Next, the TPA2016D2 transmits the data byte from the memory address being read. After receiving the data byte, the master device transmits a *not-acknowledge* followed by a stop condition to complete the single-byte data read transfer.

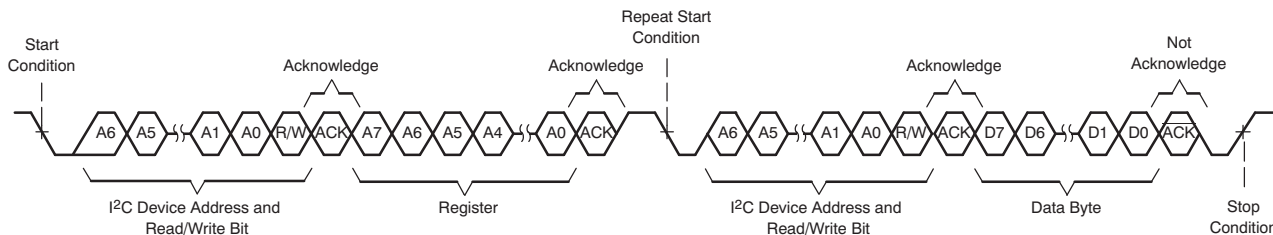

Figure 41. Single-Byte Read Transfer

9.5.6 Multiple-Byte Read

A multiple-byte data read transfer is identical to a single-byte data read transfer except that multiple data bytes are transmitted by the TPA2016D2 to the master device as shown in Figure 42. With the exception of the last data byte, the master device responds with an acknowledge bit after receiving each data byte.

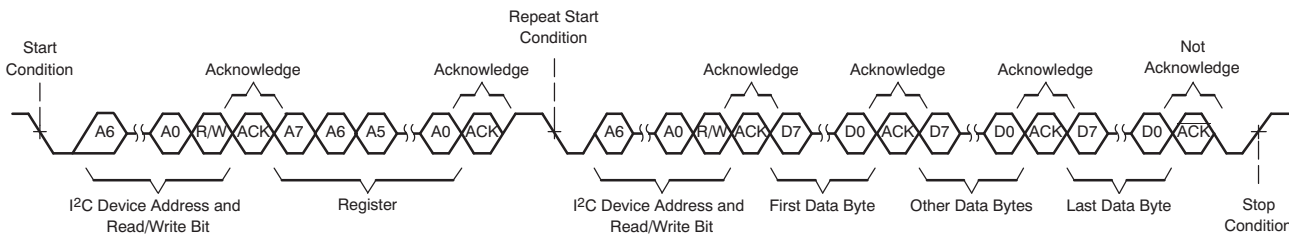

Figure 42. Multiple-Byte Read Transfer

9.6 Register Maps

Table 3. TPA2016D2 Register Map

| REGISTER | BIT7 | BIT6 | BIT5 | BIT4 | BIT3 | BIT2 | BIT1 | BIT0 |
|----------|------------------------|-------------------------|-------------------------|--------------------------|--------------------------|--------------------------|--------------------------|--------------------------|
| 1 | SPK_EN_R | SPL_EN_L | SWS | FAULT_R | FAULT_L | Thermal | 1 | NG_EN |
| 2 | 0 | 0 | ATK_time [5] | ATK_time [4] | ATK_time [3] | ATK_time [2] | ATK_time [1] | ATK_time [0] |
| 3 | 0 | 0 | REL_time [5] | REL_time [4] | REL_time [3] | REL_time [2] | REL_time [1] | REL_time [0] |
| 4 | 0 | 0 | Hold_time [5] | Hold_time [4] | Hold_tme [3] | Hold_time [2] | Hold_time [1] | Hold_time [0] |
| 5 | 0 | 0 | FixedGain [5] | FixedGain [4] | FixedGain [3] | FixedGain [2] | FixedGain [1] | FixedGain [0] |
| 6 | Output Limiter Disable | NoiseGate Threshold [1] | NoiseGate Threshold [2] | Output Limiter Level [4] | Output Limiter Level [3] | Output Limiter Level [2] | Output Limiter Level [1] | Output Limiter Level [0] |
| 7 | Max Gain [3] | Max Gain [2] | Max Gain [1] | Max Gain [0] | 0 | 0 | Compression Ratio [1] | Compression Ratio [0] |

The default register map values are given in [Table 4](#).

Table 4. TPA2016D2 Default Register Values Table

| REGISTER | 0x01 | 0x02 | 0x03 | 0x04 | 0x05 | 0x06 | 0x07 |
|----------|------|------|------|------|------|------|------|
| Default | C3h | 05h | 0Bh | 00h | 06h | 3Ah | C2h |

Any register above address 0x08 is reserved for testing and must not be written to because it may change the function of the device. If read, these bits may assume any value.

Some of the default values can be reprogrammed through the I²C interface and written to the EEPROM. This function is useful to speed up the turnon time of the device and minimizes the number of I²C writes. If this is required, contact your local TI representative.

The TPA2016D2 I²C address is 0xB0 (binary 10110000) for writing and 0xB1 (binary 10110001) for reading. If a different I²C address is required, please contact your local TI representative. See [General I²C Operation](#) for more details.

The following tables show the details of the registers, the default values, and the values that can be programmed through the I²C interface.

Table 5. IC Function Control (Address: 1)

| REGISTER ADDRESS | I ² C BIT | LABEL | DEFAULT | DESCRIPTION |
|---------------------------------------------|----------------------|----------|-------------|----------------------------------------------------------------------------------|
| 01 (01 _H) – IC Function Control | 7 | SPK_EN_R | 1 (enabled) | Enables right amplifier |
| | 6 | SPK_EN_L | 1 (enabled) | Enables left amplifier |
| | 5 | SWS | 0 (enabled) | Shutdown IC when bit = 1 |
| | 4 | FAULT_R | 0 | Changes to a 1 when there is a short on the right channel. Reset by writing a 0. |
| | 3 | FAULT_L | 0 | Changes to a 1 when there is a short on the left channel. Reset by writing a 0 |
| | 2 | Thermal | 0 | Changes to a 1 when die temperature is above 150°C |
| | 1 | UNUSED | 1 | |
| | 0 | NG_EN | 1 (enabled) | Enables Noise Gate function |

SPK_EN_R:

Enable bit for the right-channel amplifier. Amplifier is active when bit is high. This function is gated by thermal and returns once the IC is below the threshold temperature.

SPK_EN_L:

Enable bit for the left-channel amplifier. Amplifier is active when bit is high. This function is gated by thermal and returns once the IC is below the threshold temperature

SWS:

Software shutdown control. The device is in software shutdown when the bit is 1 (control, bias and oscillator are inactive). When the bit is 0 the control, bias and oscillator are enabled.

Fault_L:

This bit indicates that an over-current event has occurred on the left channel with a 1. This bit is cleared by writing a 0 to it.

Fault_R:

This bit indicates that an over-current event has occurred on the right channel with a 1. This bit is cleared by writing a 0 to it.

Thermal:

This bit indicates a thermal shutdown that was initiated by the hardware with a 1. This bit is deglitched and latched, and can be cleared by writing a 0 to it.

NG_EN:

Enable bit for the Noise Gate function. This function is enabled when this bit is high. This function can only be enabled when the Compression ratio is not 1:1.

Table 6. AGC Attack Control (Address: 2)

| REGISTER ADDRESS | I ² C BIT | LABEL | DEFAULT | DESCRIPTION | | | |
|-------------------------------------|----------------------|----------|-------------------------|-----------------------------------------------|-----------|----------|-----------|
| 02 (02 _H) – AGC Control | 7:6 | Unused | 00 | | | | |
| | 5:0 | ATK_time | 000101 (6.4 ms/6 dB) | AGC Attack time (gain ramp down) | | | |
| | | | | | Per Step | Per 6 dB | 90% Range |
| | | | | 000001 | 0.1067 ms | 1.28 ms | 5.76 ms |
| | | | | 000010 | 0.2134 ms | 2.56 ms | 11.52 ms |
| | | | | 000011 | 0.3201 ms | 3.84 ms | 17.19 ms |
| | | | | 000100 | 0.4268 ms | 5.12 ms | 23.04 ms |
| | | | | (time increases by 0.1067 ms with every step) | | | |
| 111111 | 6.722 ms | 80.66 ms | 362.99 ms | | | | |

ATK_time

These bits set the attack time for the AGC function. The attack time is the minimum time between gain decreases.

Table 7. AGC Release Control (Address: 3)

| REGISTER ADDRESS | I ² C BIT | LABEL | DEFAULT | DESCRIPTION | | | |
|---------------------------------------------|----------------------|----------|---------------------------|----------------------------------------------|----------|----------|-----------|
| 03 (03 _H) – AGC Release Control | 7:6 | Unused | 00 | | | | |
| | 5:0 | REL_time | 001011 (1.81 sec/6 dB) | AGC Release time (gain ramp down) | | | |
| | | | | | Per Step | Per 6 dB | 90% Range |
| | | | | 000001 | 0.0137 s | 0.1644 s | 0.7398 s |
| | | | | 000010 | 0.0274 s | 0.3288 s | 1.4796 s |
| | | | | 000011 | 0.0411 s | 0.4932 s | 2.2194 s |
| | | | | 000100 | 0.0548 s | 0.6576 s | 2.9592 s |
| | | | | (time increases by 0.0137 s with every step) | | | |
| 111111 | 0.8631 s | 10.36 s | 46.6 s | | | | |

REL_time

These bits set the release time for the AGC function. The release time is the minimum time between gain increases.

Table 8. AGC Hold Time Control (Address: 4)

| REGISTER ADDRESS | I ² C BIT | LABEL | DEFAULT | DESCRIPTION | |
|-----------------------------------------------|----------------------|-----------|-------------------|---------------|-------------------|
| 04 (04 _H) – AGC Hold Time Control | 7:6 | Unused | 00 | | |
| | 5:0 | Hold_time | 000000 (Disabled) | AGC Hold time | |
| | | | | | Per Step |
| | | | | 000000 | Hold Time Disable |
| | | | | 000001 | 0.0137 s |
| | | | | 000010 | 0.0274 s |
| | | | | 000011 | 0.0411 s |
| | | | | 000100 | 0.0548 s |
| (time increases by 0.0137 s with every step) | | | | | |
| 111111 | 0.8631 s | | | | |

Hold_time

These bits set the hold time for the AGC function. The hold time is the minimum time between a gain decrease (attack) and a gain increase (release). The hold time can be deactivated.

Table 9. AGC Fixed Gain Control (Address: 5)

| REGISTER ADDRESS | I ² C BIT | LABEL | DEFAULT | DESCRIPTION | | | | | | | | | | | | | | | | | | | | | | | | | | | | | | | |
|------------------------------------------------|----------------------|------------|-------------|--------------------------------------------------------------------------------------------------------------------------------------------------------------------------------------------------------------------------------------------------------------------------------------------------------------------------------------------------------------------------------------------------------------------------------------------------------------------------------------------------------------------------------------------------------------------------------------------------------------------------------------------------------------------------------------------------------------------------------------------------------------------------------------------------------------------------------------------------------------------------------------------------------------------|--|------|--------|--------|--------|--------|--------|--------|------------------------------------------|--|--------|-------|--------|-------|--------|-------|--------|------|--------|------|--------|------|--------|------|-----------------------------------------|--|--|-------|--|-------|--|
| 05 (05 _H) – AGC Fixed Gain Control | 7:6 | Unused | 00 | | | | | | | | | | | | | | | | | | | | | | | | | | | | | | | | |
| | 5:0 | Fixed Gain | 00110 (6dB) | Sets the fixed gain of the amplifier: two's compliment <table border="1"> <thead> <tr> <th></th> <th>Gain</th> </tr> </thead> <tbody> <tr> <td>100100</td> <td>–28 dB</td> </tr> <tr> <td>100101</td> <td>–27 dB</td> </tr> <tr> <td>100110</td> <td>–26 dB</td> </tr> <tr> <td colspan="2" style="text-align: center;">(gain increases by 1 dB with every step)</td> </tr> <tr> <td>111101</td> <td>–3 dB</td> </tr> <tr> <td>111110</td> <td>–2 dB</td> </tr> <tr> <td>111111</td> <td>–1 dB</td> </tr> <tr> <td>000000</td> <td>0 dB</td> </tr> <tr> <td>000001</td> <td>1 dB</td> </tr> <tr> <td>000010</td> <td>2 dB</td> </tr> <tr> <td>000011</td> <td>3 dB</td> </tr> <tr> <td colspan="2" style="text-align: center;">(gain increases by 1dB with every step)</td> </tr> <tr> <td></td> <td>28 dB</td> </tr> <tr> <td></td> <td>29 dB</td> </tr> <tr> <td></td> <td>30 dB</td> </tr> </tbody> </table> | | Gain | 100100 | –28 dB | 100101 | –27 dB | 100110 | –26 dB | (gain increases by 1 dB with every step) | | 111101 | –3 dB | 111110 | –2 dB | 111111 | –1 dB | 000000 | 0 dB | 000001 | 1 dB | 000010 | 2 dB | 000011 | 3 dB | (gain increases by 1dB with every step) | | | 28 dB | | 29 dB | |
| | Gain | | | | | | | | | | | | | | | | | | | | | | | | | | | | | | | | | | |
| 100100 | –28 dB | | | | | | | | | | | | | | | | | | | | | | | | | | | | | | | | | | |
| 100101 | –27 dB | | | | | | | | | | | | | | | | | | | | | | | | | | | | | | | | | | |
| 100110 | –26 dB | | | | | | | | | | | | | | | | | | | | | | | | | | | | | | | | | | |
| (gain increases by 1 dB with every step) | | | | | | | | | | | | | | | | | | | | | | | | | | | | | | | | | | | |
| 111101 | –3 dB | | | | | | | | | | | | | | | | | | | | | | | | | | | | | | | | | | |
| 111110 | –2 dB | | | | | | | | | | | | | | | | | | | | | | | | | | | | | | | | | | |
| 111111 | –1 dB | | | | | | | | | | | | | | | | | | | | | | | | | | | | | | | | | | |
| 000000 | 0 dB | | | | | | | | | | | | | | | | | | | | | | | | | | | | | | | | | | |
| 000001 | 1 dB | | | | | | | | | | | | | | | | | | | | | | | | | | | | | | | | | | |
| 000010 | 2 dB | | | | | | | | | | | | | | | | | | | | | | | | | | | | | | | | | | |
| 000011 | 3 dB | | | | | | | | | | | | | | | | | | | | | | | | | | | | | | | | | | |
| (gain increases by 1dB with every step) | | | | | | | | | | | | | | | | | | | | | | | | | | | | | | | | | | | |
| | 28 dB | | | | | | | | | | | | | | | | | | | | | | | | | | | | | | | | | | |
| | 29 dB | | | | | | | | | | | | | | | | | | | | | | | | | | | | | | | | | | |
| | 30 dB | | | | | | | | | | | | | | | | | | | | | | | | | | | | | | | | | | |

Fixed Gain

These bits are used to select the fixed gain of the amplifier. If the Compression is enabled, fixed gain is adjustable from –28 dB to 30 dB. If the Compression is disabled, fixed gain is adjustable from 0 dB to 30 dB.

Table 10. AGC Control (Address: 6)

| REGISTER ADDRESS | I ² C BIT | LABEL | DEFAULT | DESCRIPTION | | | |
|-------------------------------------|----------------------|------------------------|---------------------------|--------------------------------------------------------------------------------------------------------|---------------------|--------------------------|------|
| 06 (06 _H) – AGC Control | 7 | Output Limiter Disable | 0 (enable) | Disables the output limiter function. Can only be disabled when the AGC compression ratio is 1:1 (off) | | | |
| | 6:5 | NoiseGate Threshold | 01 (4 mV _{rms}) | Select the threshold of the noise gate | | | |
| | | | | | Threshold | | |
| | | | | 00 | 1 mV _{rms} | | |
| | | | | 01 | 4 mV _{rms} | | |
| | 4:0 | Output Limiter Level | 11010 (6.5 dBV) | Selects the output limiter level | | | |
| | | | | | Output Power (Wrms) | Peak Output Voltage (Vp) | dBV |
| | | | | 00000 | 0.03 | 0.67 | –6.5 |
| | | | | 00001 | 0.03 | 0.71 | –6 |
| | | | | 00010 | 0.04 | 0.75 | –5.5 |
| | | | | (Limiter level increases by 0.5 dB with every step) | | | |
| | | | | 11101 | 0.79 | 3.55 | 8 |
| | | | | 11110 | 0.88 | 3.76 | 8.5 |
| 11111 | 0.99 | 3.99 | 9 | | | | |

Output Limiter Disable This bit disables the output limiter function when set to 1. Can only be disabled when the AGC compression ratio is 1:1

NoiseGate Threshold These bits set the threshold level of the noise gate. NoiseGate Threshold is only functional when the compression ratio is not 1:1

Output Limiter Level These bits select the output limiter level. Output Power numbers are for 8-Ω load.

Table 11. AGC Control (Address: 7)

| REGISTER ADDRESS | I ² C BIT | LABEL | DEFAULT | DESCRIPTION | |
|-------------------------------------|------------------------------------------|-------------------|--------------|----------------------------------------------|-------|
| 07 (07 _H) – AGC Control | 7:4 | Max Gain | 1100 (30 dB) | Selects the maximum gain the AGC can achieve | |
| | | | | | Gain |
| | | | | 0000 | 18 dB |
| | | | | 0001 | 19 dB |
| | | | | 0010 | 20 dB |
| | (gain increases by 1 dB with every step) | | | | |
| | 3:2 | Unused | 00 | 1100 | 30 dB |
| | | | | | |
| | 1:0 | Compression Ratio | 10 (4:1) | Selects the compression ratio of the AGC | |
| | | | | | Ratio |
| 00 | | | | 1:1 (off) | |
| 01 | | | | 2:1 | |
| 10 | | | | 4:1 | |
| 11 | 8:1 | | | | |

Compression Ratio These bits select the compression ratio. Output Limiter is enabled by default when the compression ratio is not 1:1.

Max Gain These bits select the maximum gain of the amplifier. In order to maximize the use of the AGC, set the Max Gain to 30 dB

10 Application and Implementation

NOTE

Information in the following applications sections is not part of the TI component specification, and TI does not warrant its accuracy or completeness. TI's customers are responsible for determining suitability of components for their purposes. Customers should validate and test their design implementation to confirm system functionality.

10.1 Application Information

These typical connection diagrams highlight the required external components and system level connections for proper operation of the device. Each of these configurations can be realized using the Evaluation Modules (EMs) for the device. These flexible modules allow full evaluation of the device in the most common modes of operation. Any design variation can be supported by TI through schematic and layout reviews. Visit e2e.ti.com for design assistance and join the audio amplifier discussion forum for additional information.

10.2 Typical Applications

10.2.1 TPA2016D2 With Differential Input Signal

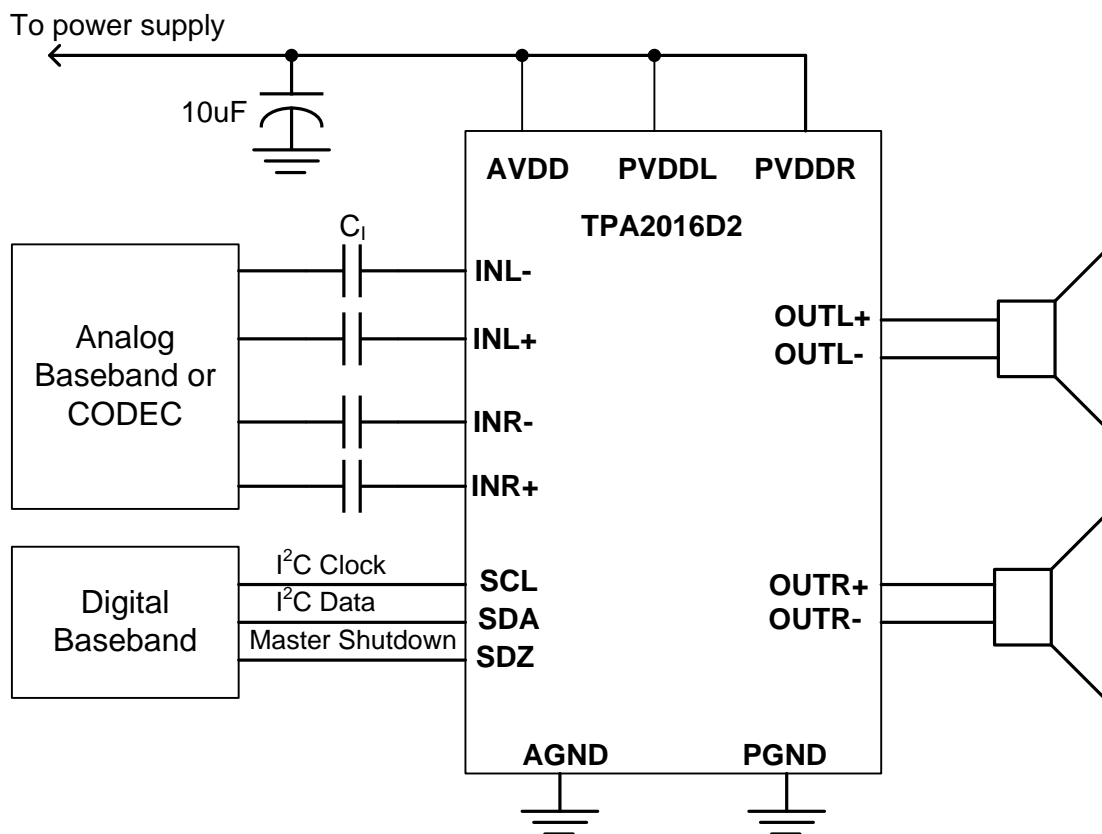

Copyright © 2016, Texas Instruments Incorporated

Figure 43. Typical Application Schematic With Differential Input Signals

Typical Applications (continued)

10.2.1.1 Design Requirements

For this design example, use the parameters listed in [Table 12](#).

Table 12. Design Parameters

| PARAMETER | EXAMPLE VALUE |
|---------------|---------------|
| Power supply | 5 V |
| Enable inputs | High > 1.3 V |
| | Low < 0.6 V |
| Speaker | 8 Ω |

10.2.1.2 Detailed Design Procedure

10.2.1.2.1 Surface Mount Capacitors

Temperature and applied DC voltage influence the actual capacitance of high-K materials. [Table 13](#) shows the relationship between the different types of high-K materials and their associated tolerances, temperature coefficients, and temperature ranges. Notice that a capacitor made with X5R material can lose up to 15% of its capacitance within its working temperature range.

In an application, the working capacitance of components made with high-K materials is generally much lower than nominal capacitance. A worst-case result with a typical X5R material might be –10% tolerance, –15% temperature effect, and –45% DC voltage effect at 50% of the rated voltage. This particular case would result in a working capacitance of 42% ($0.9 \times 0.85 \times 0.55$) of the nominal value.

Select high-K ceramic capacitors according to the following rules:

1. Use capacitors made of materials with temperature coefficients of X5R, X7R, or better.
2. Use capacitors with DC voltage ratings of at least twice the application voltage. Use minimum 10-V capacitors for the TPA2016D2.
3. Choose a capacitance value at least twice the nominal value calculated for the application. Multiply the nominal value by a factor of 2 for safety. If a 10-μF capacitor is required, use 20 μF.

The preceding rules and recommendations apply to capacitors used in connection with the TPA2016D2. The TPA2016D2 cannot meet its performance specifications if the rules and recommendations are not followed.

Table 13. Typical Tolerance and Temperature Coefficient of Capacitance by Material

| MATERIAL | COG/NPO | X7R | X5R |
|-----------------------|--------------|--------------|-------------|
| Typical tolerance | ±5% | ±10% | 80 / –20% |
| Temperature | ±30 ppm | ±15% | 22 / –82% |
| Temperature range, °C | –55 to 125°C | –55 to 125°C | –30 to 85°C |

10.2.1.2.2 Decoupling Capacitor, C_S

The TPA2016D2 is a high-performance Class-D audio amplifier that requires adequate power supply decoupling to ensure the efficiency is high and total harmonic distortion (THD) is low. For higher frequency transients, spikes, or digital hash on the line, a good low equivalent-series-resistance (ESR) 1-μF ceramic capacitor (typically) placed as close as possible to the device PVDD (L, R) lead works best. Placing this decoupling capacitor close to the TPA2016D2 is important for the efficiency of the Class-D amplifier, because any resistance or inductance in the trace between the device and the capacitor can cause a loss in efficiency. For filtering lower-frequency noise signals, a 4.7-μF or greater capacitor placed near the audio power amplifier would also help, but it is not required in most applications because of the high PSRR of this device.

10.2.1.2.3 Input Capacitors, C_I

The input capacitors and input resistors form a high-pass filter with the corner frequency, f_c , determined in [Equation 5](#).

$$f_c = \frac{1}{(2\pi \times R_1 \times C_1)} \tag{5}$$

The value of the input capacitor is important to consider as it directly affects the bass (low frequency) performance of the circuit. Speakers in wireless phones cannot usually respond well to low frequencies, so the corner frequency can be set to block low frequencies in this application. Not using input capacitors can increase output offset. Equation 6 is used to solve for the input coupling capacitance. If the corner frequency is within the audio band, the capacitors must have a tolerance of ±10% or better, because any mismatch in capacitance causes an impedance mismatch at the corner frequency and below.

$$C_1 = \frac{1}{(2\pi \times R_1 \times f_c)} \tag{6}$$

10.2.1.3 Application Curves

For application curves, see the figures listed in Table 14.

Table 14. Table of Graphs

| DESCRIPTION | FIGURE NUMBER |
|--------------------------------|---------------|
| Output Level vs Input Level | Figure 5 |
| THD+N vs Frequency | Figure 10 |
| THD+N vs Output Power | Figure 13 |
| Output Power vs Supply Voltage | Figure 21 |

10.2.2 TPA2016D2 With Single-Ended Input Signal

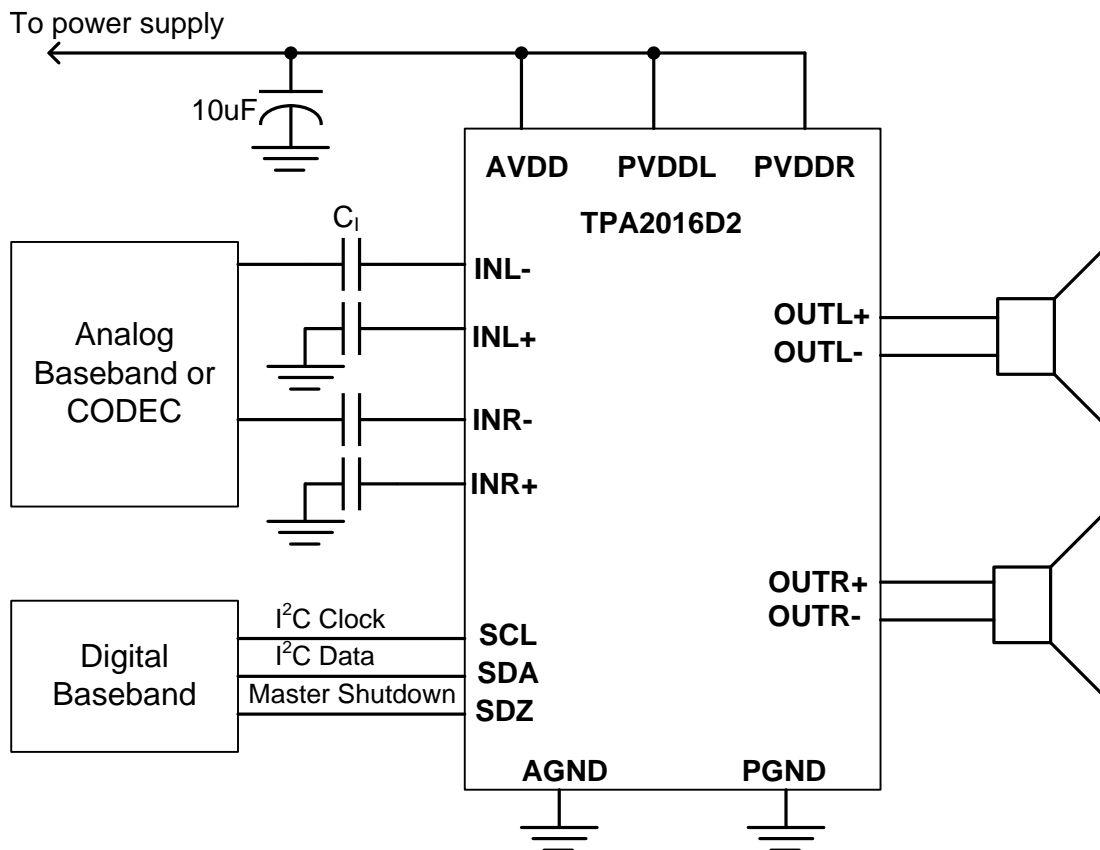

Copyright © 2016, Texas Instruments Incorporated

Figure 44. Typical Application Schematic With Single-Ended Input Signal

10.2.2.1 Design Requirements

For this design example, use the parameters listed in [Table 12](#).

10.2.2.2 Detailed Design Procedure

For the design procedure see [Detailed Design Procedure](#).

10.2.2.3 Application Curves

For application curves, see the figures listed in [Table 14](#).

11 Power Supply Recommendations

The TPA2016D2 is designed to operate from an input voltage supply range between 2.5 V and 5.5 V. Therefore the output voltage range of the power supply must be within this range. The current capability of upper power must not exceed the maximum current limit of the power switch.

11.1 Power Supply Decoupling Capacitors

The TPA2016D2 requires adequate power supply decoupling to ensure a high efficiency operation with low total harmonic distortion (THD). Place a low equivalent-series-resistance (ESR) ceramic capacitor, typically 0.1 μF , within 2 mm of the VDD/VCCOUT pin. This choice of capacitor and placement helps with higher frequency transients, spikes, or digital hash on the line. In addition to the 0.1- μF ceramic capacitor, is recommended to place a 2.2- μF to 10- μF capacitor on the VDD supply trace. This larger capacitor acts as a charge reservoir, providing energy faster than the board supply, thus helping to prevent any droop in the supply voltage.

12 Layout

12.1 Layout Guidelines

12.1.1 Component Location

Place all the external components very close to the TPA2016D2. Placing the decoupling capacitor, C_S , close to the TPA2016D2 is important for the efficiency of the Class-D amplifier. Any resistance or inductance in the trace between the device and the capacitor can cause a loss in efficiency.

12.1.2 Trace Width

Recommended trace width at the solder balls is 75 μm to 100 μm to prevent solder wicking onto wider PCB traces. For high current pins (PVDD (L, R), PGND, and audio output pins) of the TPA2016D2, use 100- μm trace widths at the solder balls and at least 500- μm PCB traces to ensure proper performance and output power for the device. For the remaining signals of the TPA2016D2, use 75- μm to 100- μm trace widths at the solder balls. The audio input pins (INR \pm and INL \pm) must run side-by-side to maximize common-mode noise cancellation.

12.1.3 Pad Side

In making the pad size for the DSBGA balls, TI recommends that the layout use non solder mask defined (NSMD) land. With this method, the solder mask opening is made larger than the desired land area, and the opening size is defined by the copper pad width. [Figure 45](#) and [Table 15](#) shows the appropriate diameters for a DSBGA layout. The TPA2016D2 evaluation module (EVM) layout is shown in the next section as a layout example.

Layout Guidelines (continued)

Table 15. Land Pattern Dimensions⁽¹⁾⁽²⁾⁽³⁾⁽⁴⁾

| SOLDER PAD DEFINITIONS | COPPER PAD | SOLDER MASK ⁽⁵⁾ OPENING | COPPER THICKNESS | STENCIL ⁽⁶⁾⁽⁷⁾ OPENING | STENCIL THICKNESS |
|--------------------------------|-----------------------|------------------------------------|------------------|---------------------------------------|-------------------|
| Non solder mask defined (NSMD) | 275 μm (+0.0, -25 μm) | 375 μm (+0.0, -25 μm) | 1 oz max (32 μm) | 275 μm × 275 μm Sq. (rounded corners) | 125 μm thick |

- (1) Circuit traces from NSMD defined PWB lands should be 75 μm to 100 μm wide in the exposed area inside the solder mask opening. Wider trace widths reduce device stand off and impact reliability.
- (2) Best reliability results are achieved when the PWB laminate glass transition temperature is above the operating the range of the intended application.
- (3) Recommend solder paste is Type 3 or Type 4.
- (4) For a PWB using a Ni/Au surface finish, the gold thickness should be less 0.5 μm to avoid a reduction in thermal fatigue performance.
- (5) Solder mask thickness should be less than 20 μm on top of the copper circuit pattern
- (6) Best solder stencil performance is achieved using laser cut stencils with electro polishing. Use of chemically etched stencils results in inferior solder paste volume control.
- (7) Trace routing away from DSBGA device should be balanced in X and Y directions to avoid unintentional component movement due to solder wetting forces.

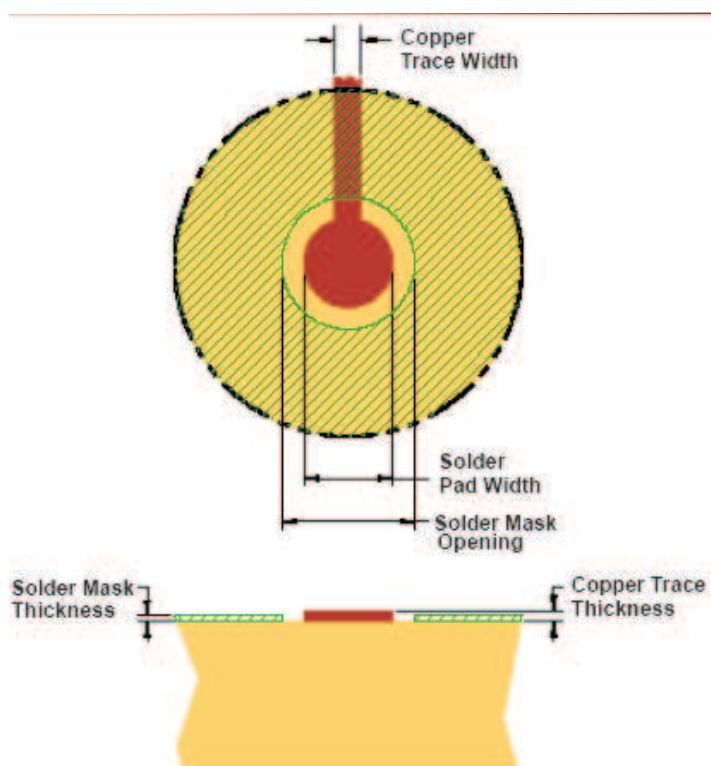
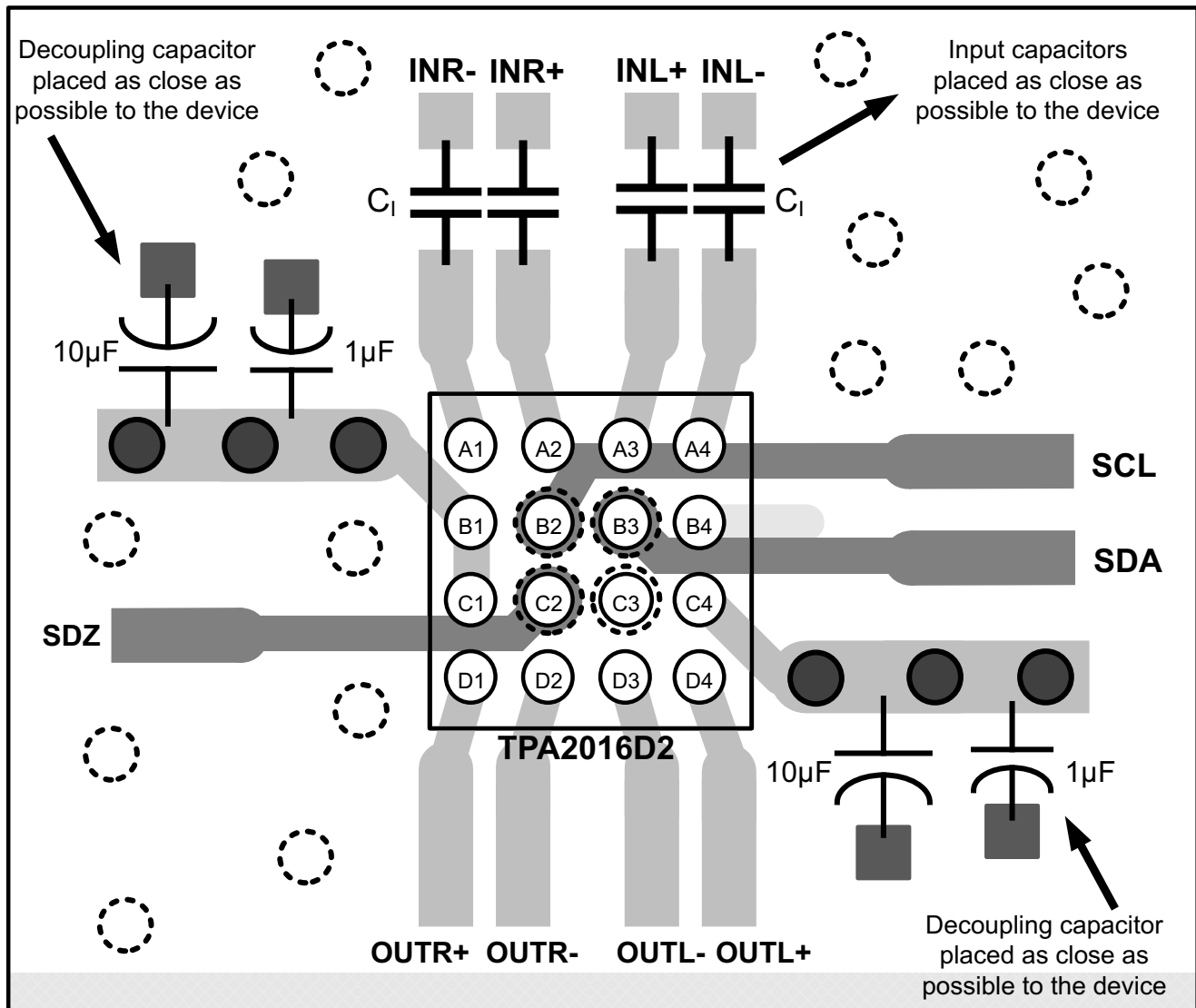

Figure 45. Land Pattern Dimensions

12.2 Layout Examples









- | | | | |
|-------------------------------------------------------------------------------------|-------------------------------|-------------------------------------------------------------------------------------|---------------------|
|  | Top Layer Ground Plane |  | Top Layer Traces |
|  | Pad to Top Layer Ground Plane |  | Bottom Layer Traces |
|  | Via to Ground Plane |  | Via to Bottom Layer |
|  | Via to Power Supply Plane | | |

Figure 46. TPA2016D2BGA Layout Recommendation

Layout Examples (continued)

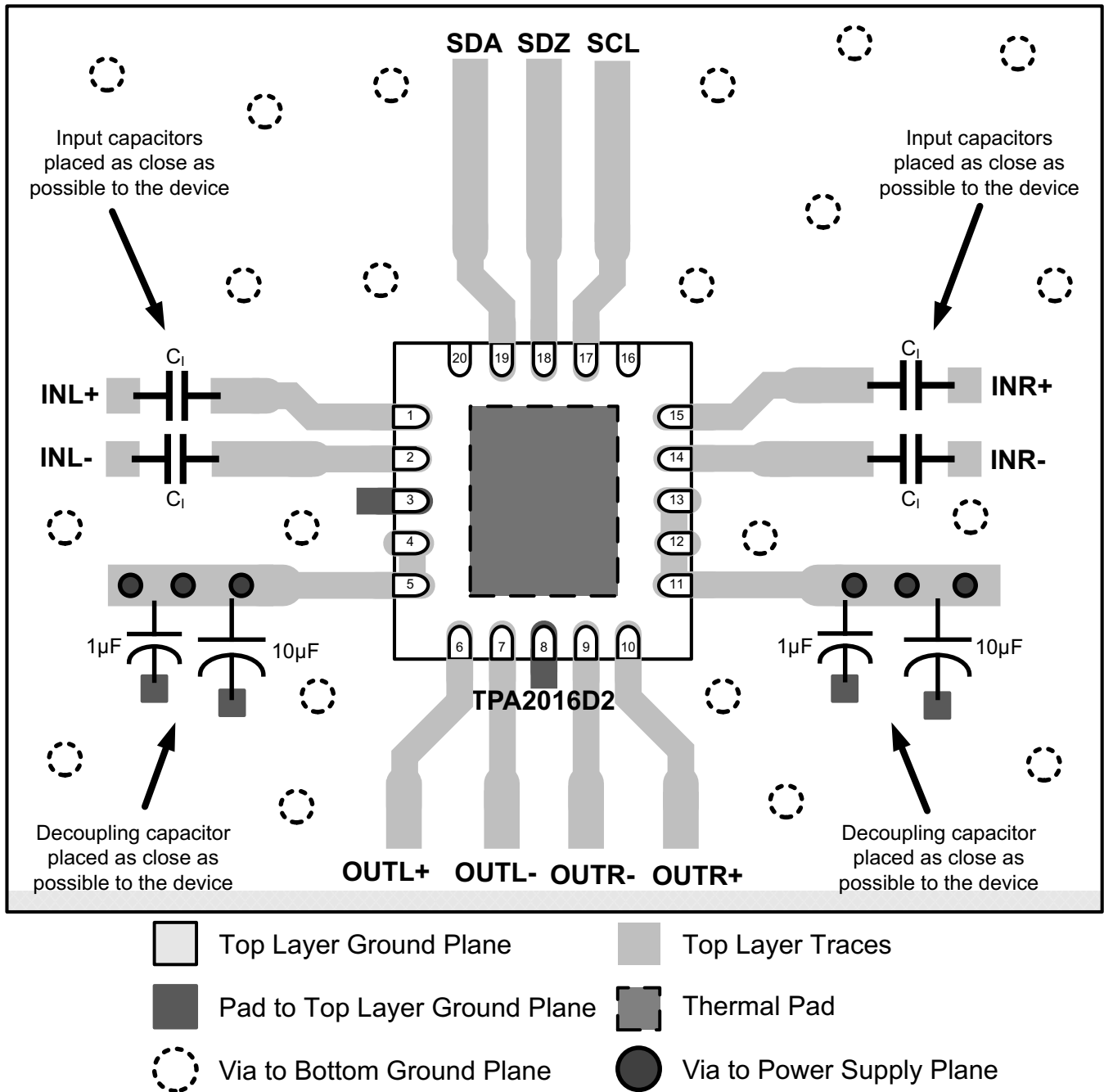

Figure 47. TPA2016D2QFN Layout Recommendation

12.3 Efficiency and Thermal Considerations

The maximum ambient temperature depends on the heat-sinking ability of the PCB system. The derating factor for the packages are shown in the dissipation rating table. Converting this to θ_{JA} for the DSBGA package:

$$\theta_{JA} = \frac{1}{\text{Derating Factor}} = \frac{1}{0.01} = 100^{\circ}\text{C/W} \quad (7)$$

Given θ_{JA} of 100°C/W , the maximum allowable junction temperature of 150°C , and the maximum internal dissipation of 0.4 W (0.2 W per channel) for 1.5 W per channel, $8\text{-}\Omega$ load, 5-V supply, from [Figure 15](#), the maximum ambient temperature can be calculated with [Equation 8](#).

$$T_{A\text{Max}} = T_{J\text{Max}} - \theta_{JA} P_{D\text{MAX}} = 150 - 100 (0.4) = 110^{\circ}\text{C} \quad (8)$$

[Equation 8](#) shows that the calculated maximum ambient temperature is 110°C at maximum power dissipation with a 5-V supply and $8\text{-}\Omega$ a load. The TPA2016D2 is designed with thermal protection that turns the device off when the junction temperature surpasses 150°C to prevent damage to the IC. Also, using speakers more resistive than $8\text{-}\Omega$ dramatically increases the thermal performance by reducing the output current and increasing the efficiency of the amplifier.

13 Device and Documentation Support

13.1 Device Support

13.1.1 Third-Party Products Disclaimer

TI'S PUBLICATION OF INFORMATION REGARDING THIRD-PARTY PRODUCTS OR SERVICES DOES NOT CONSTITUTE AN ENDORSEMENT REGARDING THE SUITABILITY OF SUCH PRODUCTS OR SERVICES OR A WARRANTY, REPRESENTATION OR ENDORSEMENT OF SUCH PRODUCTS OR SERVICES, EITHER ALONE OR IN COMBINATION WITH ANY TI PRODUCT OR SERVICE.

13.2 Community Resources

The following links connect to TI community resources. Linked contents are provided "AS IS" by the respective contributors. They do not constitute TI specifications and do not necessarily reflect TI's views; see TI's [Terms of Use](#).

TI E2E™ Online Community *TI's Engineer-to-Engineer (E2E) Community*. Created to foster collaboration among engineers. At [e2e.ti.com](#), you can ask questions, share knowledge, explore ideas and help solve problems with fellow engineers.

Design Support *TI's Design Support* Quickly find helpful E2E forums along with design support tools and contact information for technical support.

13.3 Trademarks

Nano-Free, E2E are trademarks of Texas Instruments.
All other trademarks are the property of their respective owners.

13.4 Electrostatic Discharge Caution



These devices have limited built-in ESD protection. The leads should be shorted together or the device placed in conductive foam during storage or handling to prevent electrostatic damage to the MOS gates.

13.5 Glossary

[SLYZ022](#) — *TI Glossary*.

This glossary lists and explains terms, acronyms, and definitions.

14 Mechanical, Packaging, and Orderable Information

The following pages include mechanical, packaging, and orderable information. This information is the most current data available for the designated devices. This data is subject to change without notice and revision of this document. For browser-based versions of this data sheet, refer to the left-hand navigation.

PACKAGING INFORMATION

| Orderable Device | Status (1) | Package Type | Package Drawing | Pins | Package Qty | Eco Plan (2) | Lead/Ball Finish (6) | MSL Peak Temp (3) | Op Temp (°C) | Device Marking (4/5) | Samples |
|------------------|---------------|--------------|-----------------|------|-------------|-------------------------|-------------------------|----------------------|--------------|-------------------------|-------------------------|
| TPA2016D2RTJR | ACTIVE | QFN | RTJ | 20 | 3000 | Green (RoHS & no Sb/Br) | NIPDAU | Level-2-260C-1 YEAR | -40 to 85 | TPA 2016D2 | Samples |
| TPA2016D2RTJT | ACTIVE | QFN | RTJ | 20 | 250 | Green (RoHS & no Sb/Br) | NIPDAU | Level-2-260C-1 YEAR | -40 to 85 | TPA 2016D2 | Samples |
| TPA2016D2YZHR | ACTIVE | DSBGA | YZH | 16 | 3000 | Green (RoHS & no Sb/Br) | SNAGCU | Level-1-260C-UNLIM | -40 to 85 | CCJ | Samples |
| TPA2016D2YZHT | ACTIVE | DSBGA | YZH | 16 | 250 | Green (RoHS & no Sb/Br) | SNAGCU | Level-1-260C-UNLIM | -40 to 85 | CCJ | Samples |

(1) The marketing status values are defined as follows:

ACTIVE: Product device recommended for new designs.

LIFEBUY: TI has announced that the device will be discontinued, and a lifetime-buy period is in effect.

NRND: Not recommended for new designs. Device is in production to support existing customers, but TI does not recommend using this part in a new design.

PREVIEW: Device has been announced but is not in production. Samples may or may not be available.

OBSELETE: TI has discontinued the production of the device.

(2) **RoHS:** TI defines "RoHS" to mean semiconductor products that are compliant with the current EU RoHS requirements for all 10 RoHS substances, including the requirement that RoHS substance do not exceed 0.1% by weight in homogeneous materials. Where designed to be soldered at high temperatures, "RoHS" products are suitable for use in specified lead-free processes. TI may reference these types of products as "Pb-Free".

RoHS Exempt: TI defines "RoHS Exempt" to mean products that contain lead but are compliant with EU RoHS pursuant to a specific EU RoHS exemption.

Green: TI defines "Green" to mean the content of Chlorine (Cl) and Bromine (Br) based flame retardants meet JS709B low halogen requirements of <=1000ppm threshold. Antimony trioxide based flame retardants must also meet the <=1000ppm threshold requirement.

(3) MSL, Peak Temp. - The Moisture Sensitivity Level rating according to the JEDEC industry standard classifications, and peak solder temperature.

(4) There may be additional marking, which relates to the logo, the lot trace code information, or the environmental category on the device.

(5) Multiple Device Markings will be inside parentheses. Only one Device Marking contained in parentheses and separated by a "-" will appear on a device. If a line is indented then it is a continuation of the previous line and the two combined represent the entire Device Marking for that device.

(6) Lead/Ball Finish - Orderable Devices may have multiple material finish options. Finish options are separated by a vertical ruled line. Lead/Ball Finish values may wrap to two lines if the finish value exceeds the maximum column width.

Important Information and Disclaimer:The information provided on this page represents TI's knowledge and belief as of the date that it is provided. TI bases its knowledge and belief on information provided by third parties, and makes no representation or warranty as to the accuracy of such information. Efforts are underway to better integrate information from third parties. TI has taken and

continues to take reasonable steps to provide representative and accurate information but may not have conducted destructive testing or chemical analysis on incoming materials and chemicals. TI and TI suppliers consider certain information to be proprietary, and thus CAS numbers and other limited information may not be available for release.

In no event shall TI's liability arising out of such information exceed the total purchase price of the TI part(s) at issue in this document sold by TI to Customer on an annual basis.

TAPE AND REEL INFORMATION



QUADRANT ASSIGNMENTS FOR PIN 1 ORIENTATION IN TAPE



*All dimensions are nominal

| Device | Package Type | Package Drawing | Pins | SPQ | Reel Diameter (mm) | Reel Width W1 (mm) | A0 (mm) | B0 (mm) | K0 (mm) | P1 (mm) | W (mm) | Pin1 Quadrant |
|---------------|--------------|-----------------|------|------|--------------------|--------------------|---------|---------|---------|---------|--------|---------------|
| TPA2016D2RTJR | QFN | RTJ | 20 | 3000 | 330.0 | 12.4 | 4.25 | 4.25 | 1.15 | 8.0 | 12.0 | Q2 |
| TPA2016D2RTJR | QFN | RTJ | 20 | 3000 | 330.0 | 12.4 | 4.3 | 4.3 | 1.1 | 8.0 | 12.0 | Q2 |
| TPA2016D2RTJT | QFN | RTJ | 20 | 250 | 180.0 | 12.4 | 4.25 | 4.25 | 1.15 | 8.0 | 12.0 | Q2 |
| TPA2016D2RTJT | QFN | RTJ | 20 | 250 | 180.0 | 12.4 | 4.3 | 4.3 | 1.1 | 8.0 | 12.0 | Q2 |
| TPA2016D2YZHR | DSBGA | YZH | 16 | 3000 | 180.0 | 8.4 | 2.18 | 2.18 | 0.81 | 4.0 | 8.0 | Q1 |
| TPA2016D2YZHT | DSBGA | YZH | 16 | 250 | 180.0 | 8.4 | 2.18 | 2.18 | 0.81 | 4.0 | 8.0 | Q1 |

TAPE AND REEL BOX DIMENSIONS



*All dimensions are nominal

| Device | Package Type | Package Drawing | Pins | SPQ | Length (mm) | Width (mm) | Height (mm) |
|---------------|--------------|-----------------|------|------|-------------|------------|-------------|
| TPA2016D2RTJR | QFN | RTJ | 20 | 3000 | 367.0 | 367.0 | 35.0 |
| TPA2016D2RTJR | QFN | RTJ | 20 | 3000 | 370.0 | 355.0 | 55.0 |
| TPA2016D2RTJT | QFN | RTJ | 20 | 250 | 210.0 | 185.0 | 35.0 |
| TPA2016D2RTJT | QFN | RTJ | 20 | 250 | 195.0 | 200.0 | 45.0 |
| TPA2016D2YZHR | DSBGA | YZH | 16 | 3000 | 182.0 | 182.0 | 20.0 |
| TPA2016D2YZHT | DSBGA | YZH | 16 | 250 | 182.0 | 182.0 | 20.0 |

MECHANICAL DATA

RTJ (S-PWQFN-N20)

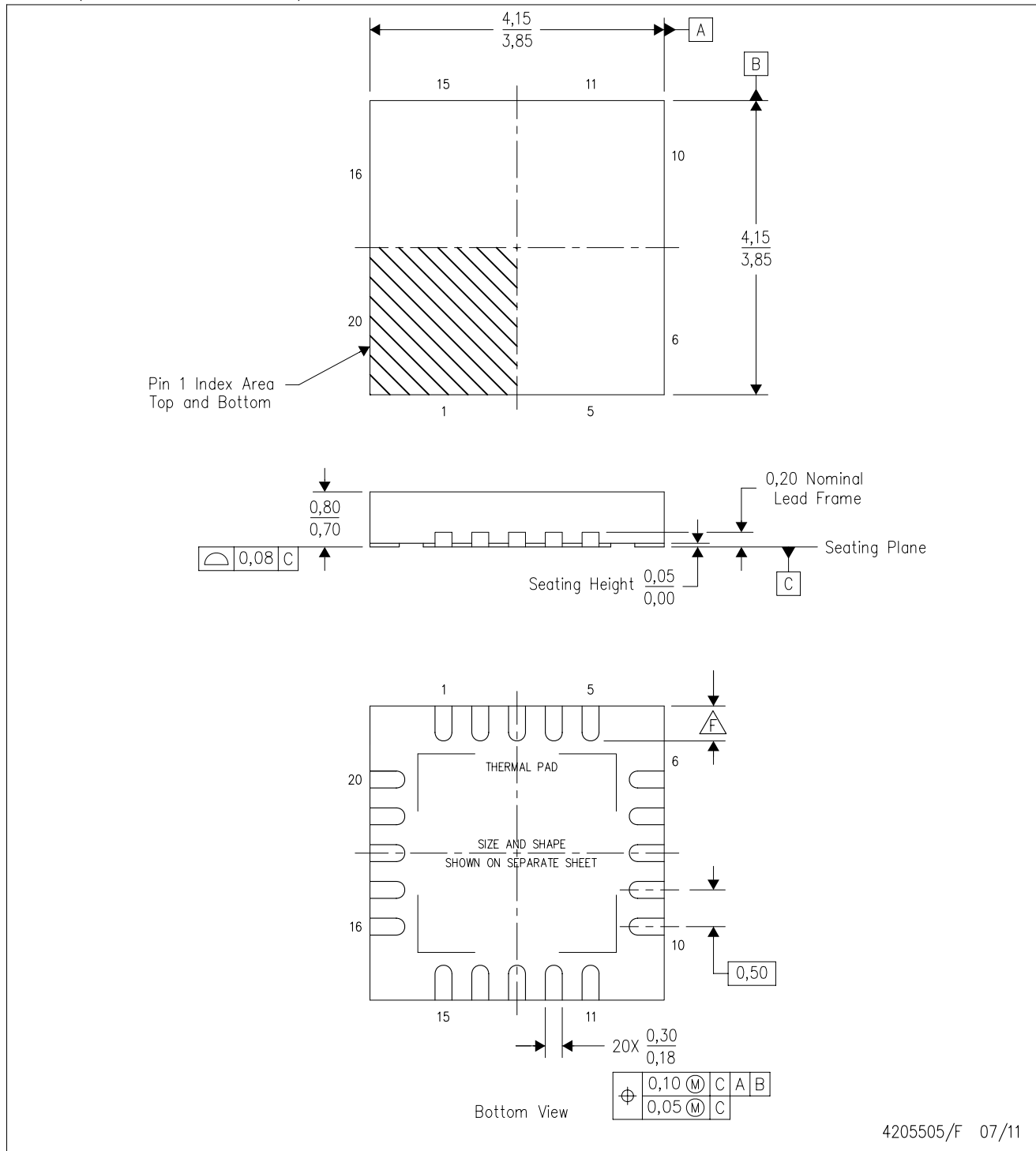
PLASTIC QUAD FLATPACK NO-LEAD



4205505/F 07/11

- NOTES:
- All linear dimensions are in millimeters. Dimensioning and tolerancing per ASME Y14.5-1994.
 - This drawing is subject to change without notice.
 - QFN (Quad Flatpack No-Lead) package configuration.
 - The package thermal pad must be soldered to the board for thermal and mechanical performance.
 - See the additional figure in the Product Data Sheet for details regarding the exposed thermal pad features and dimensions.
 - Check thermal pad mechanical drawing in the product datasheet for nominal lead length dimensions.

RTJ (S-PWQFN-N20)

PLASTIC QUAD FLATPACK NO-LEAD

THERMAL INFORMATION

This package incorporates an exposed thermal pad that is designed to be attached directly to an external heatsink. The thermal pad must be soldered directly to the printed circuit board (PCB). After soldering, the PCB can be used as a heatsink. In addition, through the use of thermal vias, the thermal pad can be attached directly to the appropriate copper plane shown in the electrical schematic for the device, or alternatively, can be attached to a special heatsink structure designed into the PCB. This design optimizes the heat transfer from the integrated circuit (IC).

For information on the Quad Flatpack No-Lead (QFN) package and its advantages, refer to Application Report, QFN/SON PCB Attachment, Texas Instruments Literature No. SLUA271. This document is available at www.ti.com.

The exposed thermal pad dimensions for this package are shown in the following illustration.

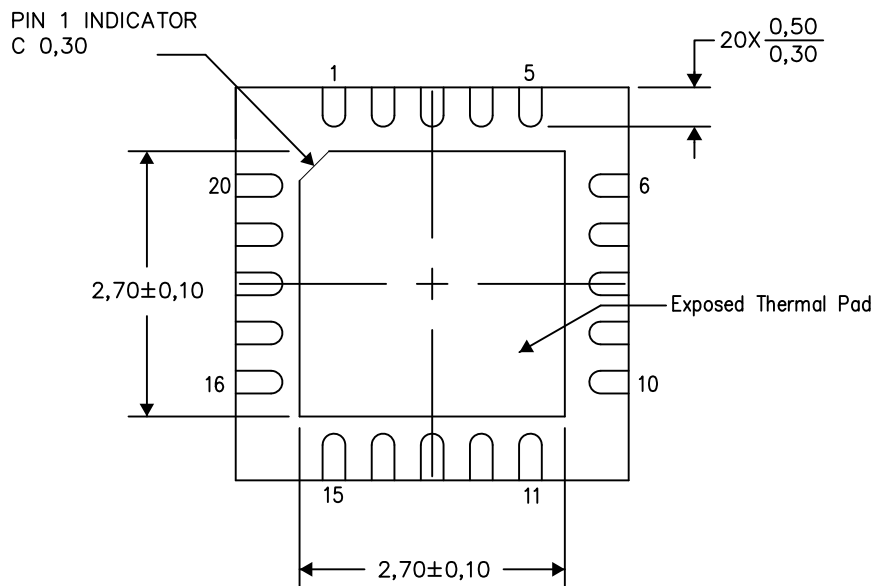

Bottom View

Exposed Thermal Pad Dimensions

4206256-2/V 05/15

NOTE: All linear dimensions are in millimeters

RTJ (S-PWQFN-N20)

PLASTIC QUAD FLATPACK NO-LEAD

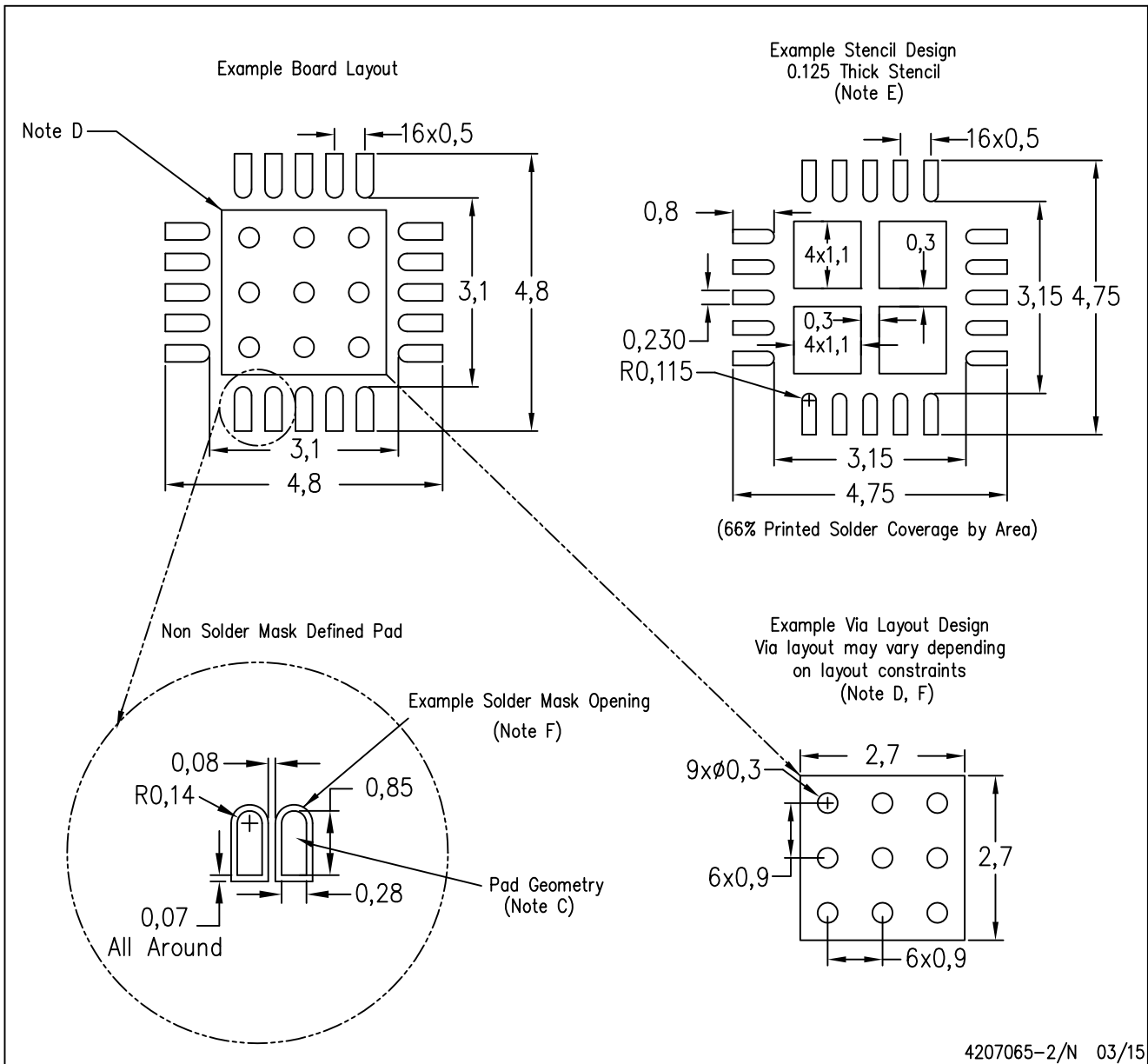

- NOTES:
- All linear dimensions are in millimeters.
 - This drawing is subject to change without notice.
 - Publication IPC-7351 is recommended for alternate designs.
 - This package is designed to be soldered to a thermal pad on the board. Refer to Application Note, Quad Flat-Pack Packages, Texas Instruments Literature No. SLUA271, and also the Product Data Sheets for specific thermal information, via requirements, and recommended board layout. These documents are available at www.ti.com <<http://www.ti.com>>.
 - Laser cutting apertures with trapezoidal walls and also rounding corners will offer better paste release. Customers should contact their board assembly site for stencil design recommendations. Refer to IPC 7525 for stencil design considerations.
 - Customers should contact their board fabrication site for recommended solder mask tolerances and via tenting recommendations for vias placed in the thermal pad.

YZH (S-XBGA-N16)

DIE-SIZE BALL GRID ARRAY

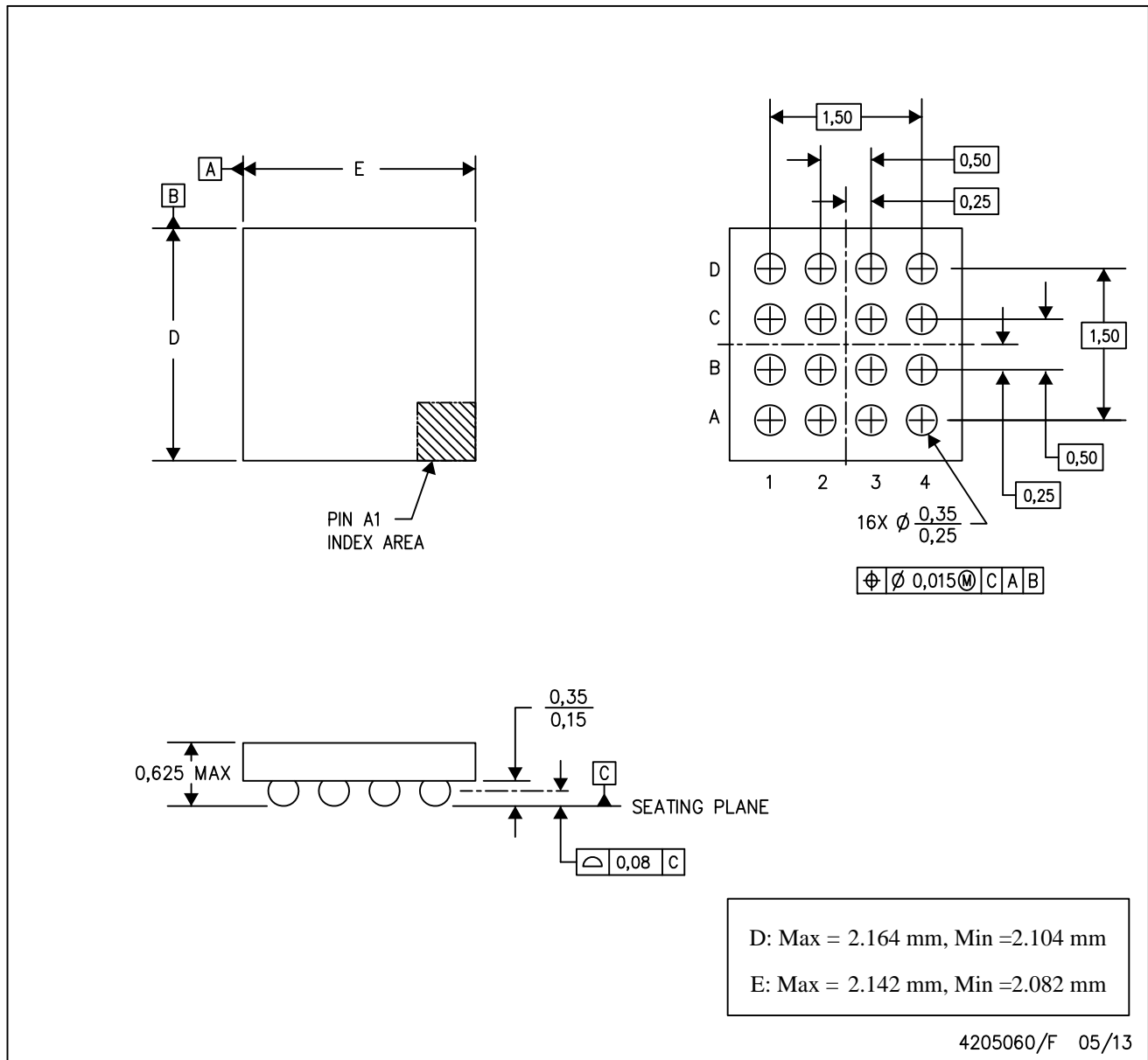

- NOTES:
- A. All linear dimensions are in millimeters.
 - B. This drawing is subject to change without notice.
 - C. NanoFree™ package configuration.

IMPORTANT NOTICE AND DISCLAIMER

TI PROVIDES TECHNICAL AND RELIABILITY DATA (INCLUDING DATASHEETS), DESIGN RESOURCES (INCLUDING REFERENCE DESIGNS), APPLICATION OR OTHER DESIGN ADVICE, WEB TOOLS, SAFETY INFORMATION, AND OTHER RESOURCES "AS IS" AND WITH ALL FAULTS, AND DISCLAIMS ALL WARRANTIES, EXPRESS AND IMPLIED, INCLUDING WITHOUT LIMITATION ANY IMPLIED WARRANTIES OF MERCHANTABILITY, FITNESS FOR A PARTICULAR PURPOSE OR NON-INFRINGEMENT OF THIRD PARTY INTELLECTUAL PROPERTY RIGHTS.

These resources are intended for skilled developers designing with TI products. You are solely responsible for (1) selecting the appropriate TI products for your application, (2) designing, validating and testing your application, and (3) ensuring your application meets applicable standards, and any other safety, security, or other requirements. These resources are subject to change without notice. TI grants you permission to use these resources only for development of an application that uses the TI products described in the resource. Other reproduction and display of these resources is prohibited. No license is granted to any other TI intellectual property right or to any third party intellectual property right. TI disclaims responsibility for, and you will fully indemnify TI and its representatives against, any claims, damages, costs, losses, and liabilities arising out of your use of these resources.

TI's products are provided subject to TI's Terms of Sale (www.ti.com/legal/termsofsale.html) or other applicable terms available either on ti.com or provided in conjunction with such TI products. TI's provision of these resources does not expand or otherwise alter TI's applicable warranties or warranty disclaimers for TI products.

Mailing Address: Texas Instruments, Post Office Box 655303, Dallas, Texas 75265
Copyright © 2020, Texas Instruments Incorporated