

# Johnson SMPM Connectors

■ Connectivity for  
Business-Critical Continuity



Emerson Network Power Connectivity Solutions offers the Johnson line of SMPM connectors. The sub-miniature, push-on style micro interfaces are distinguished for their size (about 35% smaller than the SMP design) and becoming increasingly popular for the two-fold design benefit of allowing for a higher-density of connection points and maintaining solid Return Loss performance from DC-level frequencies up to 65 GHz.

The Johnson SMPM family includes PC mount and End Launch styles, straight and right-angled, .047 cabled connectors and sealable flange mounts. All male connectors are offered as full detent or smooth bore designs for your preference of separation forces.









The SMPM bullet adapter provides the same coveted blind mate functionality as the larger SMP size connectors, mitigating radial and axial misalignment with negligible change to VSWR and other signal losses. The SMPM-series is perfect for use in test equipment and racked-electronics where footprint space is a premium and mating boards together is difficult.

For those systems with even tighter tolerance restrictions on center to center spacing, multi-channel blocks for straight or right-angle interfaces can be designed and quoted through Emerson Connectivity Solutions responsive product design team.

## Key Features & Benefits

- 35% smaller than SMP connectors
- DC-65 GHz
- Bullet adapter provides Blind Mate capabilities
- Available in PC mount, End Launch and Cabled styles

## SMPM Product Family

Part Number	Description	
125-0801-201	Straight PC Mount, Female	
125-0701-201 125-2701-201	Straight PC Mount Male, Full Detent Straight PC Mount Male, Smooth Bore	
125-0701-801 125-2701-801	End Launch Male, Full Detent End Launch Male, Smooth Bore	
125-0901-801	Bullet Adapter	
125-0592-001 125-2592-001	Straight Male for .047" Cable, Full Detent Straight Male for .047" Cable, Smooth Bore	
125-0692-001	Straight Female for .047" Cable	
125-0692-101	Right Angle Female for .047" Cable	
125-0701-602 125-2701-602 142-1000-041	2-Hole Flange Mount Male Shroud, Full Detent 2-Hole Flange Mount Male Shroud, Smooth Bore Hermetic Seal Feed-Thru	
125-0000-900 125-0000-901	SMPM Extraction Tool for Cabled Connectors SMPM Bullet Adapter Installation/Extraction Tool	

The Johnson line of SMPM connectors are manufactured with high quality beryllium copper and brass components and designed to meet MIL-PRF-39012 and MIL-PRF-39012 specifications.

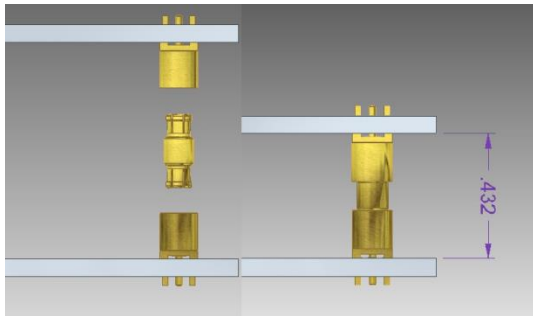

Estimated spacing between two mated boards connected via PC mount and bullet adapters

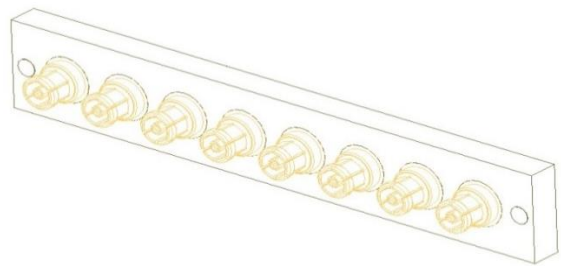

8 Port Connector Block

**Emerson Network Power.**  
The global leader in enabling  
*Business-Critical Continuity™.*

- AC Power
- Connectivity
- DC Power
- Embedded Computing

- Embedded Power
- Industrial Power
- Infrastructure Management & Monitoring
- Outside Plant

- Power Switching & Controls
- Precision Cooling
- Racks & Integrated Cabinets
- Services

Emerson Network Power  
Connectivity Solutions  
299 Johnson Ave.SW, Ste 100  
Waseca, MN 56093  
Ph: 507.833.8822

Emerson Network Power  
Connectivity Solutions (Shanghai) Co.,Ltd.  
Building 1, No. 800 Shenfu Road,  
Xinzhuang Industrial Park  
Ph: 86 21 54427668

Emerson Network Power Connectivity Solutions, Ltd.  
11 Bilton Rd  
Chelmsford  
Essex CM1 2UP  
Ph: +44 1245.359.515

[www.EmersonConnectivity.com](http://www.EmersonConnectivity.com)

# Mouser Electronics

Authorized Distributor

Click to View Pricing, Inventory, Delivery & Lifecycle Information:

[Cinch Connectivity Solutions:](#)

[125-2701-801](#)