

## Thin Film, Rectangular, Resistor Chips

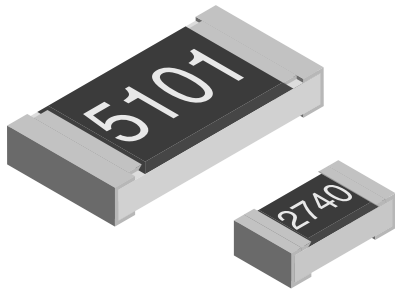

TNPW Precision Thin Film Flat Chip Resistors are the perfect choice for most fields of modern electronics where reliability and stability is of major concern. Typical applications include telecommunication, industrial, medical equipment, high-end computer and audio/video electronics.

### FEATURES

- Metal film layer on high quality ceramic
- Protective top coat
- Available with tin lead or lead (Pb)-free solder contacts
- Excellent stability at different environmental conditions
- Low temperature coefficient and tight tolerances

### APPLICATIONS

- Automotive
- Telecommunication
- Medical Equipment
- Industrial Equipment

### STANDARD ELECTRICAL SPECIFICATIONS

TYPE	POWER RATING P <sub>70°C</sub> (W)		RESISTANCE RANGE (Ω)	TEMPERATURE COEFFICIENT (ppm/K)	TOLERANCE	E-SERIES
	EN 140401-801	EIA 575				
TNPW0402	0.063	0.063	10R - 100K	± 25, ± 50	± 0.5%, ± 1%	24-192
			47R - 100K	± 10, ± 15, ± 25, ± 50	± 0.1%	
TNPW0603	0.100	0.063	10R - 332K	± 25, ± 50	± 0.1%, ± 0.5%, ± 1% <sup>1)</sup>	24-192
			47R - 332K	± 10, ± 15	± 0.1%	
TNPW0805	0.125	0.100	10R - 1M0	± 25, ± 50	± 0.1%, ± 0.5%, ± 1% <sup>1)</sup>	24-192
			47R - 1M0	± 10, ± 15	± 0.1%	
TNPW1206	0.250	0.125	10R - 2M0	± 25, ± 50	± 0.1%, ± 0.5%, ± 1% <sup>1)</sup>	24-192
			47R - 2M0	± 10, ± 15	± 0.1%	
TNPW1210	0.33 <sup>2)</sup>	0.250	10R - 3M01	± 25, ± 50	± 0.5%, ± 1% <sup>1)</sup>	24-192
			47R - 2M13	± 10, ± 15, ± 25, ± 50	± 0.1%	
TNPW2010	0.40 <sup>2)</sup>	0.400	10R - 4M99	± 25, ± 50	± 0.5%, ± 1%	24-192
			47R - 1M0	± 25, ± 50	± 0.1%	
TNPW2512	0.50 <sup>2)</sup>	0.500	10R - 8M87	± 25, ± 50	± 0.5%, ± 1%	24-192
			47R - 1M0	± 25, ± 50	± 0.1%	

<sup>1)</sup> ±1% resistors are only available in E24/E96

<sup>2)</sup> Size not specified in EN-140401-801

• Extended values available on request

• Power rating depends on the max. temperature at the solder point, the component placement density and the substrate material

• TNPW 0402 without marking

### TECHNICAL SPECIFICATIONS

PARAMETER	UNIT	TNPW0402		TNPW0603		TNPW0805		TNPW1206		TNPW1210		TNPW2010		TNPW2512	
Rated Dissipation at 70°C (EN-140401-801   EIA 575)	W	0.063	0.063	0.1	0.063	0.125	0.1	0.25	0.125	0.33	0.25		0.4		0.5
Limiting Element Voltage <sup>4)</sup>	V ≅	25		75		100		100		100		150		200	
Thermal Resistance <sup>3)</sup>	K/W	≤ 870		≤ 550		≤ 440		≤ 220		≤ 140		≤ 90		≤ 70	
Insulation Resistance	Ω	> 10 <sup>9</sup>													
Category Temperature Range	°C	- 55 / + 125 (+ 155)													
Failure Rate	h <sup>-1</sup>	0.3 • 10 <sup>-9</sup>													
Weight / 1000pcs	g	0.65		2		5.5		10		16		28		39	

<sup>3)</sup> Measuring conditions in acc. with EN 140401-801

<sup>4)</sup> Rated voltage:  $\sqrt{P \times R}$



**ORDERING INFORMATION**

Products can be ordered by using either the product description or the part number. Please note that products can be ordered with or without Lead (Pb)-free termination.

**PRODUCT DESCRIPTION** for products with **TIN LEAD** termination

TNPW-0805 MODEL	13K2 RESISTANCE VALUE	0.1% TOLERANCE	T-9 TC	RT1 PACKAGING <sup>1)</sup>
TNPW-0402	10R = 10Ω	± 0.1 %	T-2 = ± 50 ppm/K	RT7
TNPW-0603	100R = 100Ω	± 0.5 %	T-9 = ± 25 ppm/K	R52
TNPW-0805	13K2 = 13.2kΩ	± 1.0 %	T-10 = ± 15 ppm/K	RT1
TNPW-1206	1M = 1MΩ		T-13 = ± 10 ppm/K	RT6
TNPW-1210				R75
TNPW-2010				R02
TNPW-2512				R67

<sup>1)</sup> Please refer to the PACKAGING table on page 158. (Lead (Pb)-free products can be ordered using a different packaging code, plus suffix e3)

**PART NUMBER** for products with **TIN LEAD** termination

T	N	P	W	1	2	0	6	1	K	3	2	D	E	T	A		
<b>MODEL</b>	<b>VALUE</b>			<b>TOLERANCE</b>			<b>T.C.</b>			<b>PACKAGING</b>				<b>SPECIAL</b>			
TNPW 0402 TNPW 0603 TNPW 0805 TNPW 1206 TNPW 1210 TNPW 2010 TNPW 2512	R = Decimal K = Thousand M = Million			B = ± 0.1% C = ± 0.25% D = ± 0.5% F = ± 1.0%			Y = ± 10 ppm/K X = ± 15 ppm/K E = ± 25 ppm/K H = ± 50 ppm/K			TA = RT1 5000 paper tape TC = RT6 20000 paper tape TD = RT7 10000 paper tape TF = R02 4000 blister tape TG = R67 2000 blister tape CN = R52 1000 paper tape TY = R75 1000 blister tape				up to 2 digits			

**Part Numbering: TNPW12061K32DETA (Product Description: TNPW-1206 1K32 0.5% T-9 RT1)**

**PRODUCT DESCRIPTION** for products with **LEAD (Pb) FREE** termination

TNPW0805 MODEL	13K2 RESISTANCE VALUE	0.1% TOLERANCE	T9 TC	ET1 PACKAGING <sup>1)</sup>	e3 LEAD FREE STATUS
TNPW0402	10R = 10Ω	± 0.1 %	T2 = ± 50 ppm/K	ET7	e3 = Pure tin termination
TNPW0603	100R = 100Ω	± 0.5 %	T9 = ± 25 ppm/K	E52	
TNPW0805	13K2 = 13.2kΩ	± 1.0 %	T10 = ± 15 ppm/K	ET1	
TNPW1206	1M = 1MΩ		T13 = ± 10 ppm/K	ET6	
TNPW1210				E75	
TNPW2010				E02	
TNPW2512				E67	

<sup>1)</sup> Please refer to the PACKAGING table on page 158. (Lead (Pb)-free products can be ordered using a different packaging code, plus suffix e3)

**PART NUMBER** for products with **LEAD (Pb) FREE** termination

T	N	P	W	1	2	0	6	1	K	3	2	D	E	E	A		
<b>MODEL</b>	<b>VALUE</b>			<b>TOLERANCE</b>			<b>T.C.</b>			<b>PACKAGING</b>				<b>SPECIAL</b>			
TNPW 0402 TNPW 0603 TNPW 0805 TNPW 1206 TNPW 1210 TNPW 2010 TNPW 2512	R = Decimal K = Thousand M = Million			B = ± 0.1% C = ± 0.25% D = ± 0.5% F = ± 1.0%			Y = ± 10 ppm/K X = ± 15 ppm/K E = ± 25 ppm/K H = ± 50 ppm/K			EA = ET1 5000 paper tape EC = ET6 20000 paper tape ED = ET7 10000 paper tape EF = E02 4000 blister tape EG = E67 2000 blister tape EN = E52 1000 paper tape EY = E75 1000 blister tape				up to 2 digits			

**Part Numbering: TNPW12061K32DEEA (Product Description: TNPW-1206 1K32 0.5% T-9 ET1 e3)**

**DIMENSIONS**

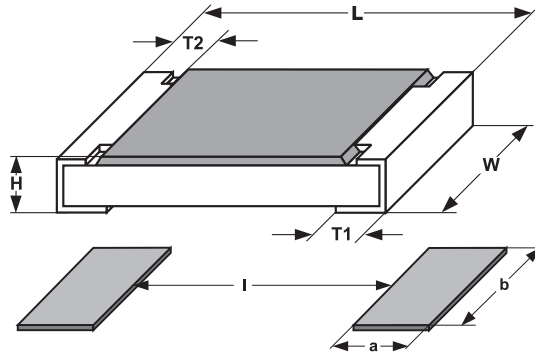

SIZE		DIMENSIONS millimeters				
INCH	METRIC	L	W	H	T1	T2
0402	1005	1.0 ± 0.05	0.5 ± 0.05	0.35 ± 0.05	0.2 ± 0.1	
0603	1608	1.6 ± 0.2	0.81 ± 0.2	0.4 ± 0.1	0.3 ± 0.2	
0805	2012	2.0 ± 0.2	1.24 ± 0.2	0.4 ± 0.1	0.4 ± 0.25	
1206	3216	3.2 ± 0.15	1.6 ± 0.15	0.61 ± 0.15	0.5 ± 0.25	
1210	3225	3.2 ± 0.15	2.49 ± 0.15	0.61 ± 0.15	0.46 ± 0.2	
2010	5025	5.0 ± 0.15	2.5 ± 0.15	0.61 ± 0.15	0.6 ± 0.25	
2512	6332	6.3 ± 0.2	3.1 ± 0.15	0.61 ± 0.15	0.6 ± 0.25	

SIZE		SOLDER PAD DIMENSIONS millimeters					
INCH	METRIC	REFLOW SOLDERING			WAVE SOLDERING		
		a	b	l	a	b	l
0402	1005	0.4	0.6	0.5	-	-	-
0603	1608	0.5	0.9	1.0	0.9	0.9	1.0
0805	2012	0.7	1.3	1.2	0.9	1.3	1.3
1206	3216	0.9	1.7	2.0	1.1	1.7	2.3
1210	3225	0.9	2.5	2.0	1.1	2.5	2.3
2010	5025	1.0	2.5	3.9	1.2	2.5	3.9
2512	6332	1.0	3.2	5.2	1.2	3.2	5.2

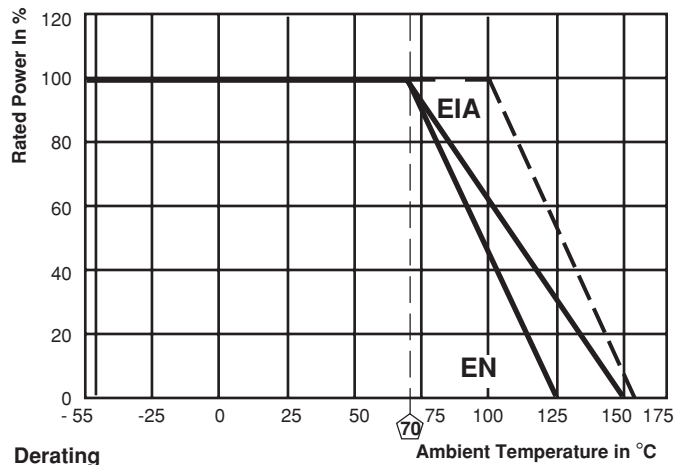
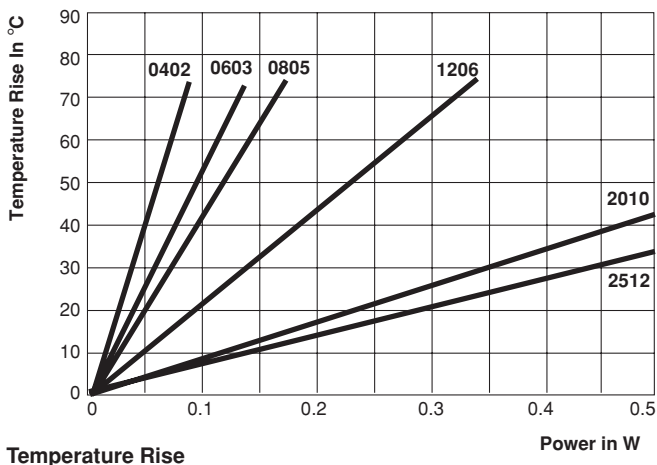



PACKAGING							
MODEL	TAPE WIDTH [mm]	PITCH [mm]	REEL DIAMETER [mm/inch]	PIECES PER REEL	TIN LEAD PACKAGING CODE	LEAD FREE (e3) PACKAGING CODE	TYPE OF CARRIER TAPE
TNPW 0402	8	2	180 / 7	10,000	RT7	ET7	Paper
TNPW 0603 TNPW 0805 TNPW 1206 TNPW 1210	8	4	180 / 7	1,000	R52 <sup>1</sup>	E52 <sup>1</sup>	Paper
TNPW 0603 TNPW 0805 TNPW 1206 TNPW 1210	8	4	180 / 7	5,000	RT1	ET1	Paper
TNPW 0603 TNPW 0805 TNPW 1206 TNPW 1210	8	4	330 / 13	20,000	RT6	ET6	Paper
TNPW 2010	12	4	180 / 7	1,000	R75	E75	Blister
				4,000	R02	E02	Blister
TNPW 2512	12	8	180 / 7	1,000	R75	E75	Blister
				2,000	R67	E67	Blister

<sup>1)</sup> R52 and E52 only for precision resistors with tolerance  $\pm 0.1\%$  and temperature coefficient  $\leq \pm 25$  ppm/k

**DESCRIPTION**

Production is strictly controlled and follows an extensive set of instructions established for reproducibility. A homogeneous film of metal alloy is deposited on a super high grade ceramic substrate and conditioned to achieve the desired temperature coefficient. A special laser is used to achieve the target value by smoothly cutting a meander groove in the resistive layer without damaging the ceramics.

**ASSEMBLY**

The resistors are suitable for processing on automatic SMD assembly systems. Beside tin lead termination TNPW is also available with lead free pure tin termination. The pure tin plating of the (Pb) lead-free resistors types provides compatibility with lead (Pb)-free and lead-containing soldering processes. The immunity of the plating against tin whisker growth has been proven under extensive testing.

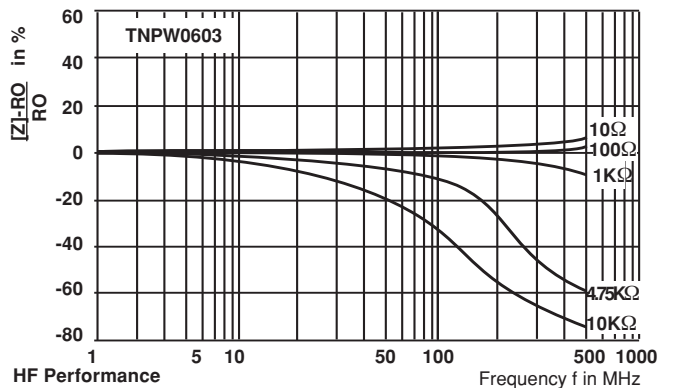
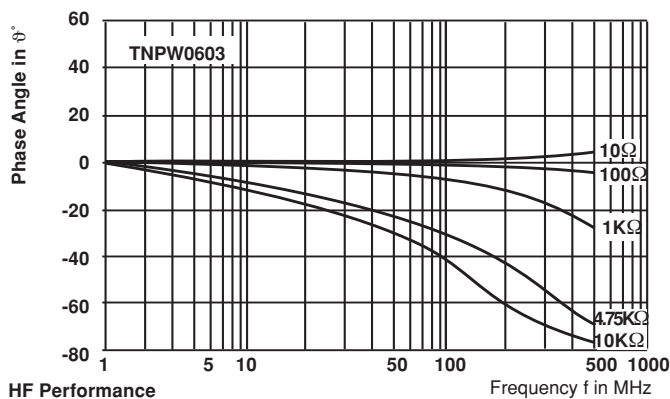
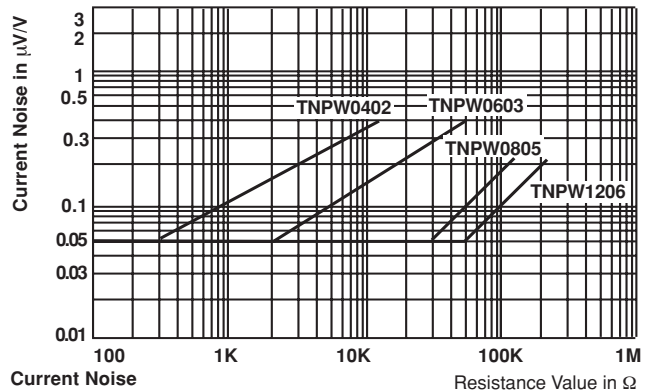
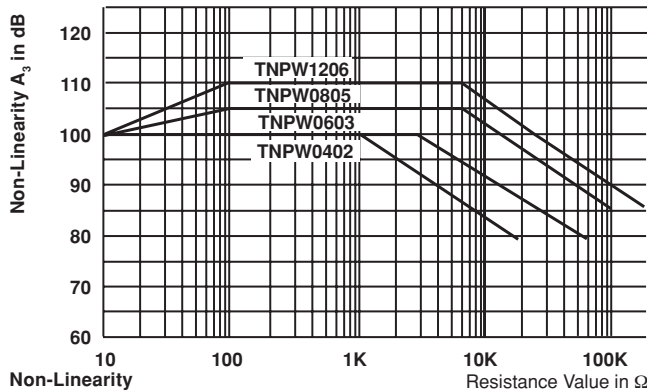

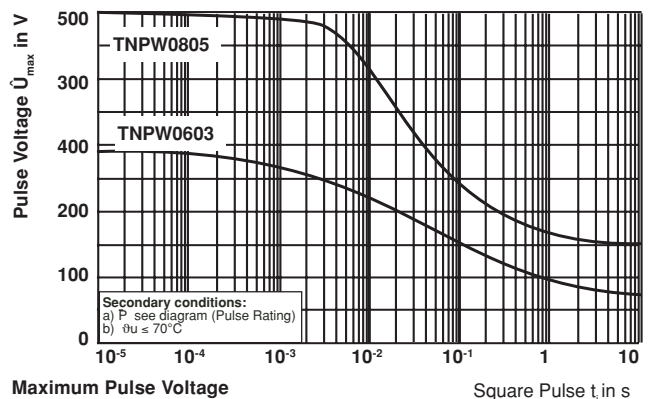
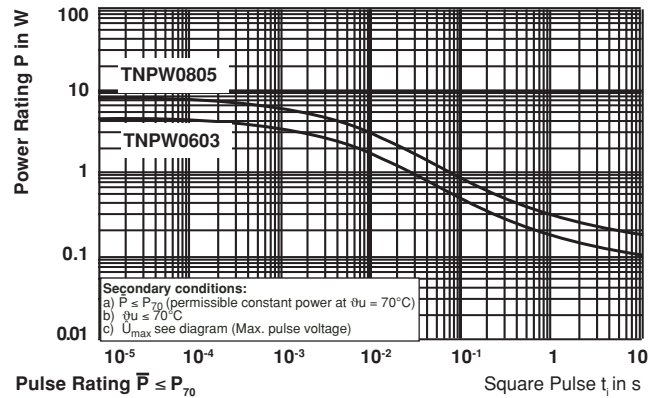
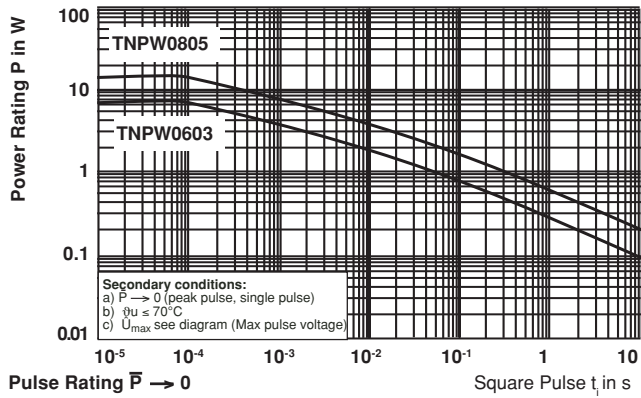
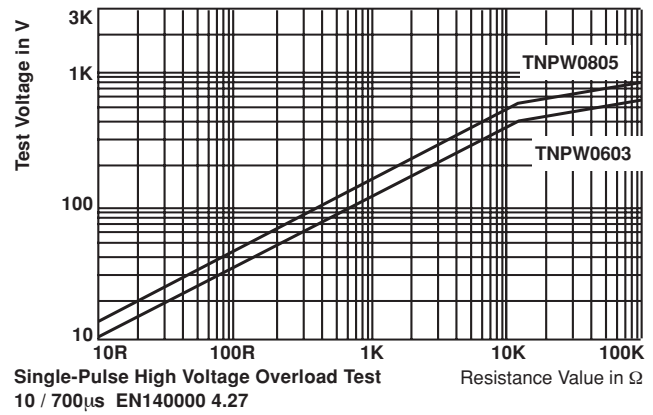
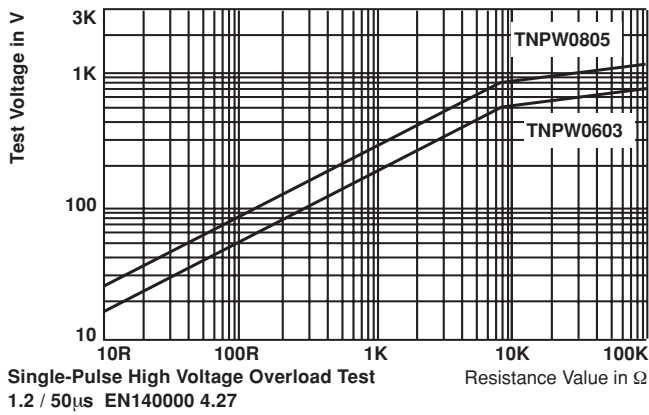
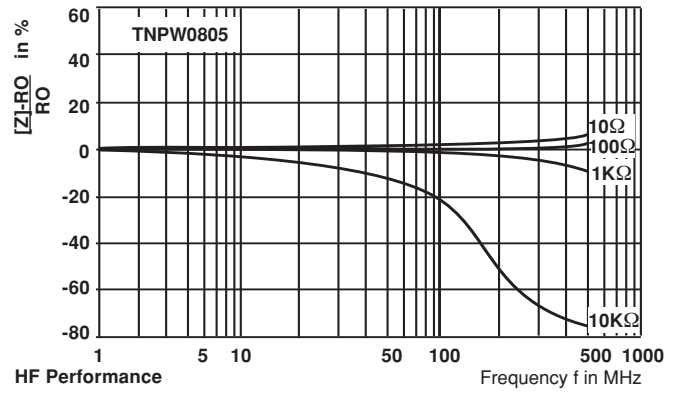
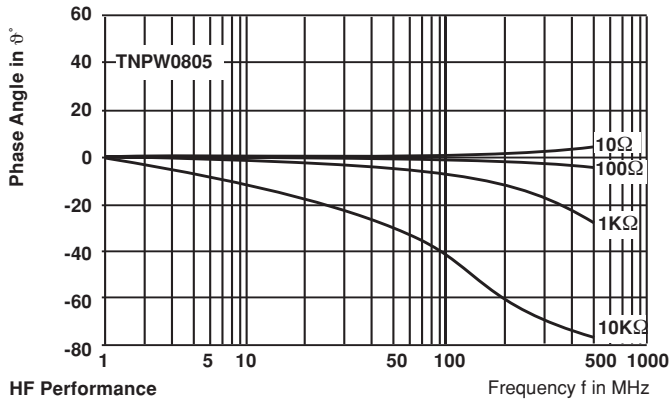



<b>PERFORMANCE</b>				
TEST	CONDITIONS OF TEST	TEST RESULTS		
		TNPW0402 TO TNPW2512		
		TOLERANCES		
		$\pm 0.1\% ; \pm 0.25\%$		$\pm 0.5\% ; \pm 1.0\%$
$< 100R$	$\geq 100R$			
Endurance Test at 70°C IEC 60115-1 4.25.1	1000 hours at 70°C, 1.5 hours "ON", 0.5 hours "OFF"	$\leq \pm 0.1\%$	$\leq \pm 0.05\%$	$\leq \pm 0.25\%$
Endurance at UCT IEC 60115-1 4.25.3	1000 hours at 125 °C without load	$\leq \pm 0.1\%$	$\leq \pm 0.05\%$	$\leq \pm 0.5\%$
Overload Test IEC 60115-1 4.13	Short time overload for 2 seconds 2.5 x rated voltage or $\leq 2$ x limiting element voltage	$\leq \pm 0.05\%$	$\leq \pm 0.02\%$	$\leq \pm 0.1\%$
Thermal Shock IEC 60115-1 4.19, IEC 60068-2-14	Rapid change between upper and lower category temperature	$\leq \pm 0.05\%$	$\leq \pm 0.02\%$	$\leq \pm 0.1\%$
Damp Heat Steady State IEC 60115-1 4.24, IEC 60068-2-3	56 days at 40°C and 93% relative humidity	$\leq \pm 0.1\%$	$\leq \pm 0.05\%$	$\leq \pm 0.5\%$
Resistance to Soldering Heat IEC 60115-1 4.18, IEC 60068-2-20	10 seconds at 260°C solder bath temperature	$\leq \pm 0.05\%$	$\leq \pm 0.02\%$	$\leq \pm 0.1\%$

<b>APPLICABLE SPECIFICATIONS</b>
<ul style="list-style-type: none"> <li>• CECC40000 / 40400</li> <li>• EN140400</li> <li>• EIA 575</li> <li>• EN 140401-801</li> <li>• EN 60115-1</li> <li>• IEC 60286-3</li> </ul>

# Mouser Electronics

Authorized Distributor

Click to View Pricing, Inventory, Delivery & Lifecycle Information:

## Vishay:

[TNPW12066043BR75](#) [TNPW08058250DR75](#) [TNPW06037152BR52](#) [TNPW08051091BR75](#) [TNPW08051491BR75](#)  
[TNPW06036040DR52](#) [TNPW08051373BR75](#) [TNPW06038060BR52](#) [TNPW06032742BR52](#) [TNPW06035052BR52](#)  
[TNPW06032321DR52](#) [TNPW12062842BR75](#) [TNPW12062912BR75](#) [TNPW12062982BR75](#) [TNPW12068761BR75](#)  
[TNPW06037K87BETY](#) [TNPW060315K0BETY](#) [TNPW06031K50BETY](#) [TNPW060324K9BETY](#) [TNPW12062743BR75](#)  
[TNPW06039761BR52](#) [TNPW120612R1FR75](#) [TNPW120620R0FR75](#) [TNPW08054640FR75](#) [TNPW06033163BR52](#)  
[TNPW06033741BR52](#) [TNPW12061762BR75](#) [TNPW08055051BR75](#) [TNPW08058002BR75](#) [TNPW12061004BR75-](#)  
[T10](#) [TNPW08052343BR75](#) [TNPW08052743BR75](#) [TNPW12065301BR75](#) [TNPW12067501BR75T10](#)  
[TNPW08056871BR75](#) [TNPW08053052BR75](#) [TNPW08051841BR75](#) [TNPW06036190BR75](#) [TNPW08053240BR75](#)  
[TNPW06036650BR52](#) [TNPW120650R5BR75](#) [TNPW08058060FR75](#) [TNPW06034532BR52](#) [TNPW08053612BR75](#)  
[TNPW06038250DR52](#) [TNPW06033830BR52](#) [TNPW12061913FR75](#) [TNPW080533R2DR75](#) [TNPW08053321DR75](#)  
[TNPW12062103BR75](#) [TNPW08053790BR75](#) [TNPW12069533BR75](#) [TNPW08051743FR75](#) [TNPW06033321DR52](#)  
[TNPW060333R2DR52](#) [TNPW12062130BR75](#) [TNPW08052581BR75](#) [TNPW08054481BR75](#) [TNPW12064931BR75](#)  
[TNPW12065831BR75](#) [TNPW12067412BR75](#) [TNPW08051093BR75](#) [TNPW08052842BR75](#) [TNPW12062291BR75](#)  
[TNPW12065691BR75](#) [TNPW12063791BR75](#) [TNPW08056262BR75](#) [TNPW08052260BR75](#) [TNPW060322R1BR52](#)  
[TNPW12062432FR75](#) [TNPW12063011FR75](#) [TNPW12063740FR75](#) [TNPW12065621FR75](#) [TNPW12065622FR75](#)  
[TNPW08058660FR75](#) [TNPW12063650BR75](#) [TNPW12061013BR75](#) [TNPW08051433BR75](#) [TNPW08054270BR75](#)  
[TNPW080571R5BR75](#) [TNPW12063090BR75](#) [TNPW06033243BR52](#) [TNPW06034641BR52](#) [TNPW06038062BR52](#)  
[TNPW12063703BR75](#) [TNPW12069882BR75](#) [TNPW06036811BR52](#) [TNPW08051371BR75](#) [TNPW08051540BR75](#)  
[TNPW08051690BR75](#) [TNPW12065971BR75](#) [TNPW080524R9BETY](#) [TNPW08052800BR75](#) [TNPW080510R0BR75](#)  
[TNPW080517R4BR75](#) [TNPW080524R3BR75](#) [TNPW080538R3BR75](#) [TNPW080582R5BR75](#) [TNPW12061470BR75](#)  
[TNPW12061651BR75](#)