

# General Specifications

## Electrical Capacity (Resistive Load)

**Power Level (silver):** 3A @ 125V AC or 3A @ 250V AC or 3A @ 30V DC  
**Logic Level (gold):** 0.4VA maximum @ 28V AC/DC maximum  
 (Applicable Range 0.1mA ~ 0.1A @ 20mV ~ 28V)

## Other Ratings

**Contact Resistance:** 50 milliohms maximum for silver; 100 milliohms maximum for gold  
**Insulation Resistance:** 200 megohms minimum @ 500V DC  
**Dielectric Strength:** 1,000V AC minimum between contacts for 1 minute minimum;  
 1,500V AC minimum between contacts & case for 1 minute minimum  
**Mechanical Life:** 1,000,000 operations minimum for momentary circuit  
 200,000 operations minimum for maintained circuit  
**Electrical Life:** 100,000 operations minimum  
**Nominal Operating Force:** Single pole: 1.5N  
 Double pole: 3.0N  
**Contact Timing:** Nonshorting (break-before-make)  
**Travel:** Pretravel .059" (1.5mm); Overtravel .059" (1.5mm); Total Travel .118" (3.0mm)

## Materials & Finishes

**Bezel:** Black: Glass fiber reinforced polyamide (UL94V-0);  
 Chrome plated: Chrome plating over ABS resin (UL94V-2)  
**Housing:** Glass fiber reinforced polyamide (UL94V-0)  
**Base:** Glass fiber reinforced polyamide (UL94V-0)  
**Movable Contactor:** Phosphor bronze with silver or gold plating  
**Movable Contacts:** Silver alloy or copper with gold plating  
**Stationary Contacts:** Silver alloy or copper with gold plating  
**Switch Terminals:** Phosphor bronze with tin plating  
**Lamp Terminals:** Phosphor bronze with tin plating

## Environmental Data

**Operating Temperature Range:** -25°C through +50°C (-13°F through +122°F) for Illuminated  
 -25°C through +70°C (-13°F through +158°F) for Nonilluminated  
**Humidity:** 90 ~ 95% humidity for 240 hours @ 40°C (104°F)  
**Vibration:** 10 ~ 55Hz with peak-to-peak amplitude of 1.5mm traversing the frequency range & returning  
 in 1 minute; 3 right angled directions for 2 hours  
**Shock:** 50G (490m/s<sup>2</sup>) acceleration (tested in 6 right angled directions, with 5 shocks in each direction)  
**Sealing:** IP65 of IEC60529 standard

## Installation

**Mounting Torque:** 0.785Nm (6.95 lb•in) maximum  
**Soldering Time & Temperature:** Manual Soldering: See Profile A in Supplement section.

## Standards & Certifications

**Flammability Standards:** UL94V-0 housing, base & black bezel  
**UL:** **File No. E44145 - Recognized only when ordered with marking on switch.**  
 Add "/CUL" before first dash in part number to order cULus marking on switch.  
 All solder lug models recognized at 3A @ 125/250V AC or 0.4VA @ 28V AC/DC maximum.

# Distinctive Characteristics

24mm square and 25mm diameter pushbuttons with the shortest above-panel dimension (1.8mm) in the industry for splashproof design.

Meets IP65 of IEC60529 standards (similar to NEMA 4 and 13), providing dust tight and splashproof panel seal protection.

Tamper resistant 18mm square and 19mm diameter actuators.

Short body of .965" (24.5mm) conserves behind-panel space.

Distinctive long stroke and light touch actuation for clear indication of circuit status.

Choice of cap colors includes clear, brushed chrome, red, green, or yellow, for enhanced panel appearance. Metallic silver cap option has bright ring illumination (round only). Unbrushed chrome has the look of stainless steel when non-illuminated, and LED color or legends when illuminated.

Brilliant illumination with multiple LED colors.

Bezel color options in black or brushed chrome.

Brushed chrome option is lighter weight than actual metal switches due to metal plating on resin.

Available in momentary and alternate action with latchdown.

Crisp actuation and clear circuit status provided by snap-action contact mechanism. Arc barrier protects against crossover.

Combination solder lug and .110" quick connect terminals. Terminals are epoxy sealed to lock out flux, dust, solvents, and other contaminants, as well as to secure terminals and improve contact stability.

Custom legends on actuator or inserts.



Actual Size (Round)

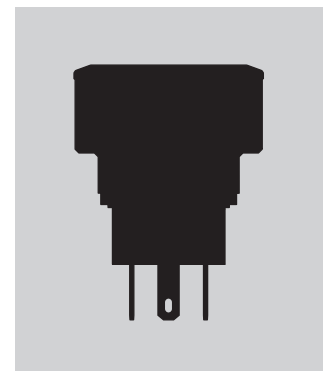

### TYPICAL SWITCH

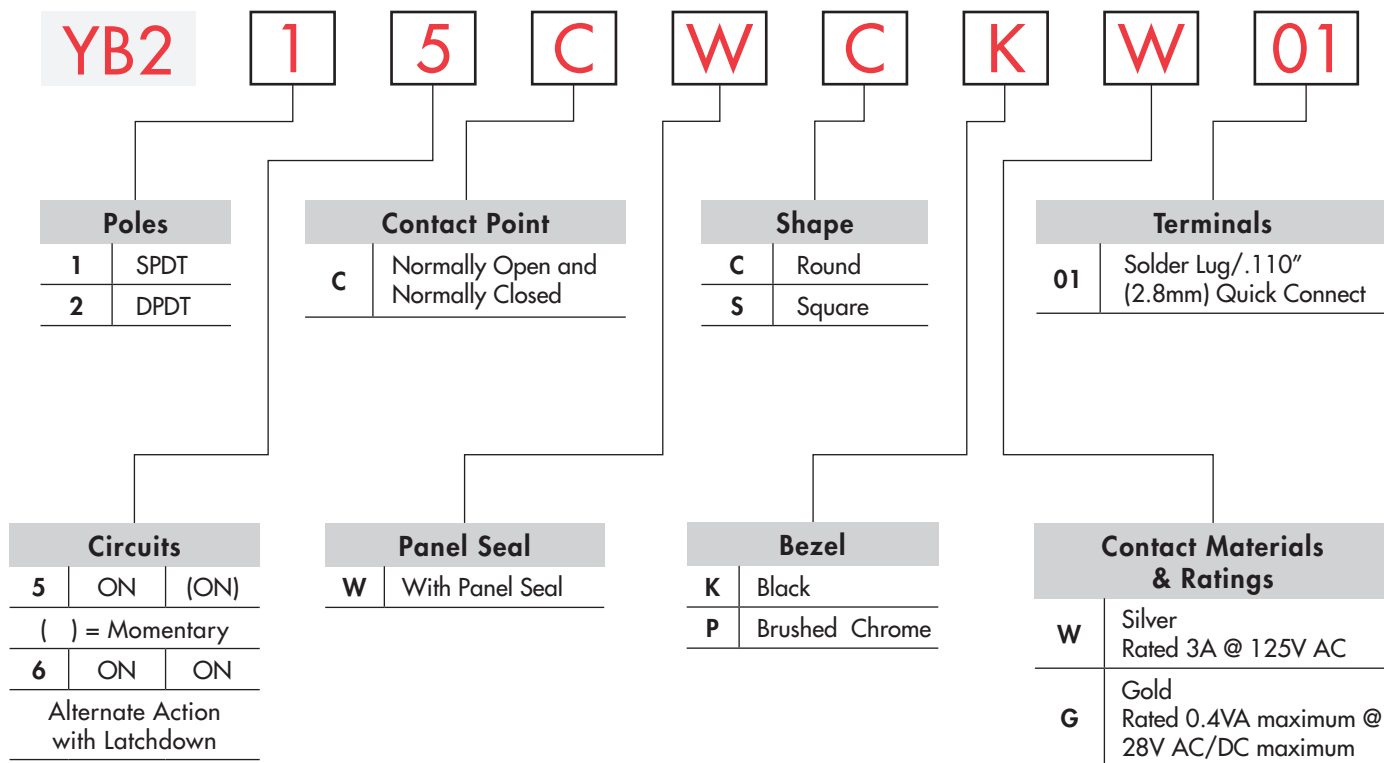

### IMPORTANT:



Switches are supplied without cULus marking unless specified.  
**cULus recognized only when ordered with marking on the switch.**  
 Specific models, ratings, and ordering instructions are noted on General Specifications page.

### DESCRIPTION FOR TYPICAL ORDERING EXAMPLE

#### YB215CWCKW01-6B-JB



ORDERING EXAMPLE



**LEDS**

Bright LED			
LED Colors		Resistor	
5C	Red	No Code	No Resistor (not for Green)
5D	Amber		05
5F	Green	12	12-volt
		24	24-volt

Super Bright LED	
6B	White
6F	Green
6G	Blue

Nonilluminated	
N	No Lamp



**Cap Types & Colors**

Lens/Diffuser Colors	
JB	Clear/White
JS	Metallic Silver Cap/Clear Ring (Round only)
CB	Red/White
EB	Yellow/White
FB	Green/White
HB	Unbrushed Chrome/White

LED and cap need to be the same color. Yellow cap pairs with amber LED to achieve amber illumination. Codes JB and JS (Round only) may be combined with all LED colors.



Lens/Diffuser Cap Colors	
JB	Clear/White
JS	Metallic Silver Cap/Clear Ring (Round only)
HB	Unbrushed Chrome/White

Cap Color	
JB	Clear/White
CB	Red/White
EB	Yellow/White
FB	Green/White
HB	Unbrushed Chrome/White
P	Brushed Chrome





**Round or Square Cap with Legend**

001	
002	START
003	STANDBY
004	STOP
005	

Contact factory for custom options.

**Round or Square Cap with Legend**

001	
002	START
003	STANDBY
004	STOP
005	

Contact factory for custom options.

Part Numbers for Unbrushed Chrome Caps with Legends

Round Cap for Bright LED	Round Cap for Super Bright LED	Square Cap for Bright or Super Bright LED
AT3017HB-001	AT3018HB-001	AT3025HB-001
AT3017HB-002	AT3018HB-002	AT3025HB-002
AT3017HB-003	AT3018HB-003	AT3025HB-003
AT3017HB-004	AT3018HB-004	AT3025HB-004
AT3017HB-005	AT3018HB-005	AT3025HB-005

Refer to Ordering Table for legend that corresponds with last 3 digits of part number.

Toggles

Rockers

Pushbuttons

Illuminated PB

Programmable

Keylocks

Rotaries

Slides

Tactiles

Tilt

Touch

Indicators

Accessories

Supplement

## POLES & CIRCUITS

		Plunger Position ( ) = Momentary		Connected Terminals		Throw & Switch/Lamp Schematics
Pole	Model	Normal	Down	Normal	Down	
SP	YB215 YB216	ON ON	(ON) ON	1-3	1-2	Notes: Switch is marked with NC, NO, COM, L+, L-. Lamp circuit is isolated and requires an external power source.
DP	YB225 YB226	ON ON	(ON) ON	1-3 4-6	1-2 4-5	

## CONTACT POINT

**C** Normally Open and Normally Closed

Contact points are both Normally Open and Normally Closed.

## PANEL SEAL

**W** Panel Seal (Round and Square)

Two o-rings provide panel seal protection meeting IP65 of IEC60529 standards.

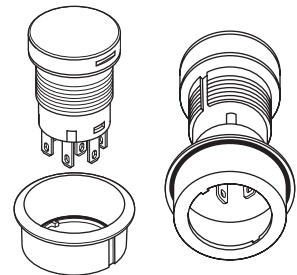

## SHAPE

**C** Round

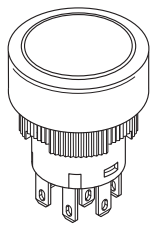

**S** Square

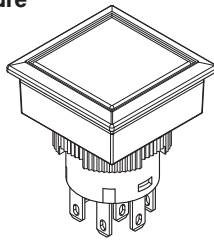

## BEZEL

**K** Black

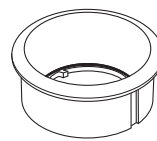

**P** Brushed Chrome

For Round or Square

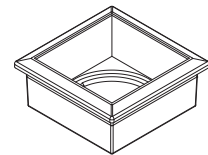

## CONTACT MATERIALS & RATINGS

**W** Silver Contacts

Power Level: 3A @ 125/250V AC  
Switch base is black

**G** Gold Contacts

Logic Level: 0.4VA max. @ 28V AC/DC max.  
Switch base is ivory

## TERMINALS

**01** Solder Lug/  
.110" (2.8mm) Quick Connect

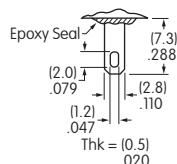

**BRIGHT & SUPER BRIGHT LEDS**

The electrical specifications shown are determined at a basic temperature of 25°C. LED circuit is isolated and requires an external power source. If the source voltage exceeds the rated voltage, a ballast resistor is required. Base of AT634 and AT636 is Black for 5V, Light Blue for 12V and Gray for 24V.

**Electrical Specifications for Bright LED without Resistor**

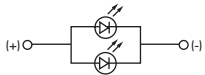
<b>Bright AT628</b>  T-1 Bi-pin 	<b>Colors Available:</b> <span style="border: 1px solid black; padding: 2px;">5C</span> Red <span style="border: 1px solid black; padding: 2px;">5D</span> Amber <span style="border: 1px solid black; padding: 2px;">No Code</span> No Resistor	Unit
	LED Colors	Red Amber
	Maximum Forward Current	$I_{FM}$ 40 40 mA
	Typical Forward Current	$I_F$ 26 26 mA
	Forward Voltage	$V_F$ 1.9 2.0 V
	Maximum Reverse Voltage	$V_{RM}$ 4 4 V
	Current Reduction Rate Above 25°C	$\Delta I_F$ 0.50 mA/°C
Ambient Temperature Range	-25 ~ +50 °C	

**Electrical Specifications for Bright Red & Amber LED with Resistor**

<b>Bright AT634</b>  T-1 1/4 Bi-pin	<b>Colors Available:</b> <span style="border: 1px solid black; padding: 2px;">5C</span> Red <span style="border: 1px solid black; padding: 2px;">5D</span> Amber <span style="border: 1px solid black; padding: 2px;">05</span> <span style="border: 1px solid black; padding: 2px;">12</span> <span style="border: 1px solid black; padding: 2px;">24</span>	Unit
	Maximum Forward Current	$I_{FM}$ — — — mA
	Typical Forward Current	$I_F$ 25 20 10 mA
	Forward Voltage	$V_F$ 5 12 24 V
	Maximum Reverse Voltage	$V_{RM}$ 4 8 16 V
	Current Reduction Rate Above 25°C	$\Delta I_F$ — — — mA/°C
	Ambient Temperature Range	-25 ~ +50 °C

AT634  
5-volt,  
2-element  
with Resistor

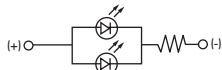

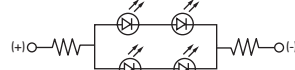

AT634  
12-volt,  
4-element  
with Resistor





AT634  
24-volt,  
4-element  
with Resistor

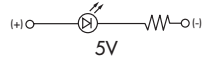
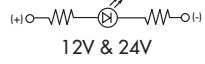

**Electrical Specifications for Bright Green LED with Resistor**

<b>Bright AT636</b>  T-1 1/4 Bi-pin  5V  12V & 24V	<b>Colors Available:</b>  <span style="border: 1px solid black; padding: 2px;">5F</span> Green <span style="border: 1px solid black; padding: 2px;">05</span> <span style="border: 1px solid black; padding: 2px;">12</span> <span style="border: 1px solid black; padding: 2px;">24</span>	Unit
	Maximum Forward Current	$I_{FM}$ — — — mA
	Typical Forward Current	$I_F$ 11 9.5 8.7 mA
	Forward Voltage	$V_F$ 5 12 24 V
	Maximum Reverse Voltage	$V_{RM}$ 5 5 5 V
	Current Reduction Rate Above 25°C	$\Delta I_F$ — — — mA/°C
	Ambient Temperature Range	-25 ~ +50 °C

**Electrical Specifications for Super Bright LED**

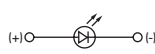
<b>Super Bright AT625G Blue AT631B White AT632F Green</b>  T-1 Bi-pin	 	<b>Colors:</b> <span style="border: 1px solid black; padding: 2px;">6B</span> White <span style="border: 1px solid black; padding: 2px;">6F</span> Green <span style="border: 1px solid black; padding: 2px;">6G</span> Blue	Unit
	Maximum Forward Current	$I_{FM}$ 30 30 30 mA	
	Typical Forward Current	$I_F$ 20 20 20 mA	
	Forward Voltage	$V_F$ 3.3 3.3 3.3 V	
	Maximum Reverse Voltage	$V_{RM}$ 7 7 7 V	
	Current Reduction Rate Above 25°C	$\Delta I_F$ 0.40 0.40 0.40 mA/°C	
	Ambient Temperature Range	-25 ~ +50 °C	

Toggles  
 Rockers  
 Pushbuttons  
**D** Illuminated PB  
 Programmable  
 Keylocks  
 Rotaries  
 Slides  
 Tactiles  
 Tilt  
 Touch  
 Indicators  
 Accessories  
 Supplement

## BALLAST RESISTOR CALCULATION FOR LEDs

If the source voltage is greater than the rated voltage of a lamp or LED, a ballast resistor must be connected in series with the lamp. This circuit diagram and formula will assist in calculating the value of the required ballast resistor.

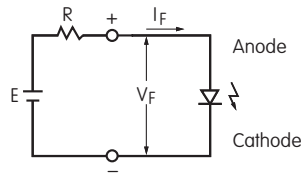

$$R = \frac{E - V_F}{I_F}$$

Where: R = Resistor Value (Ohms)  
 E = Source Voltage (V)  
 V<sub>F</sub> = Forward Voltage (V)  
 I<sub>F</sub> = Forward Current (A)

## CAPS & CAP COLORS

### AT3017 Cap for Bright LED or Nonilluminated

Lens/Diffuser Colors Available:

- JB** Clear/White
- CB** Red/White
- EB** \*Yellow/White
- FB** Green/White
- HB** Unbrushed Chrome/White

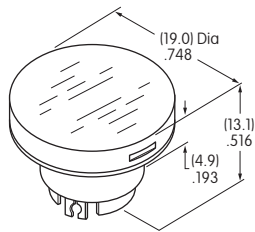

### AT3018 Cap for Super Bright LED

Lens/Diffuser Colors Available:

- JB** Clear/White
- HB** Unbrushed Chrome/White

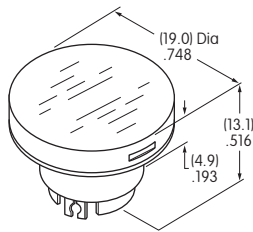

Material for Lens & Diffuser: Polycarbonate  
 HB Lens: ABS Resin & Unbrushed Chrome Plating

### AT3019 Cap for Nonilluminated

Cap Color Available:

- P** Brushed Chrome

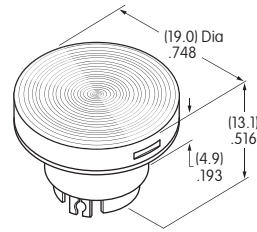

Material for Lens: ABS Resin & Brushed Chrome Plating

### AT3020 Cap with Illumination Ring for Bright or Super Bright LED

Cap Color Available:

- JS** Metallic Silver with Clear Ring

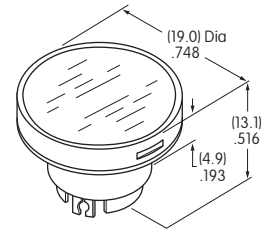

Materials  
 Lens: Polycarbonate  
 Insert: Polyester

\*Yellow cap pairs with amber LED to achieve amber illumination.

### AT3025 Cap for Illuminated or Nonilluminated

Lens/Diffuser Colors Available:

- JB** Clear/White For Bright & Super Bright LEDs
- CB** Red/White For Bright LED only
- EB** \*Yellow/White For Bright LED only
- FB** Green/White For Bright LED only
- HB** Unbrushed Chrome/White For Bright & Super Bright LEDs

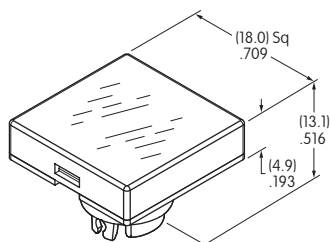

Material for Lens & Diffuser: Polycarbonate

### AT3027 Cap for Nonilluminated

Cap Color Available:

- P** Brushed Chrome

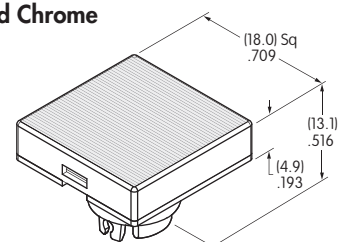

Material for Lens: ABS Resin & Brushed Chrome Plating

\*Yellow cap pairs with amber LED to achieve amber illumination.

Toggles  
Rockers  
Pushbuttons  
Illuminated PB  
Programmable  
Keylocks  
Rotaries  
Slides  
Tactiles  
Tilt  
Touch  
Indicators  
Accessories  
Supplement

Standard Legends for Unbrushed Chrome Caps

001



Round or Square Cap  
Bright or Super Bright LED

002



Round or Square Cap  
Bright or Super Bright LED

003



Round or Square Cap  
Bright or Super Bright LED

004



Round or Square Cap  
Bright or Super Bright LED

005



Round or Square Cap  
Bright or Super Bright LED

Images appear the color of the LED when lit.  
Contact factory for other legends options.

Legend illustrations are approximate representations of the actual images on the caps.

Unbrushed Chrome/White Cap with Lens/Diffuser



Without Illumination



With Illumination

Depending on the design and the color of ink used, the legend may be visible when it is not illuminated.  
It is recommended that the legend be clear and without ink in order to achieve the maximum visibility when the cap is illuminated.

Toggles

Rockers

Pushbuttons

**D** Illuminated PB

Programmable

Keylocks

Rotaries

Slides

Tactiles

Tilt

Touch

Indicators

Accessories

Supplement



## TYPICAL SWITCH DIMENSIONS

Toggles

Rockers

Pushbuttons

illuminated PB

Programmable

Keylocks

Rotaries

Slides

Tactiles

Tilt

Touch

Indicators

Accessories

Supplement

### Single Pole

### Double Pole

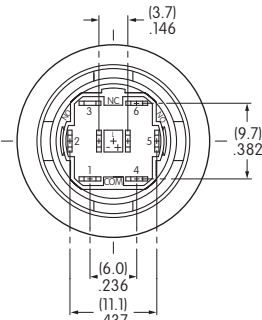
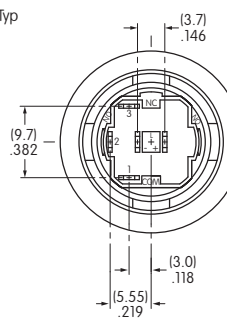
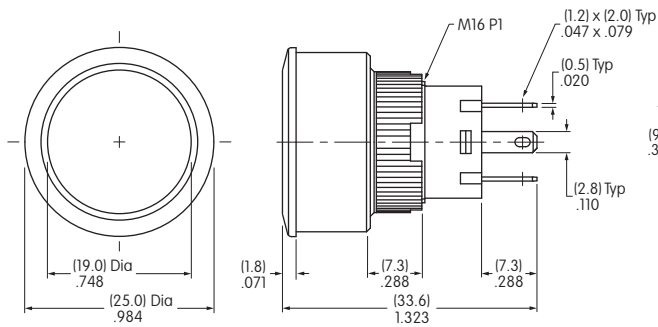

YB215CWCKW01-6B-JB

### Single Pole

### Double Pole

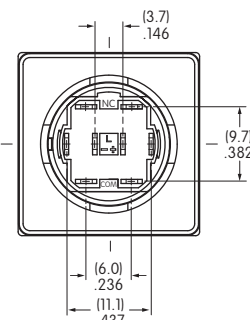
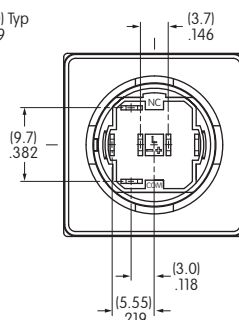
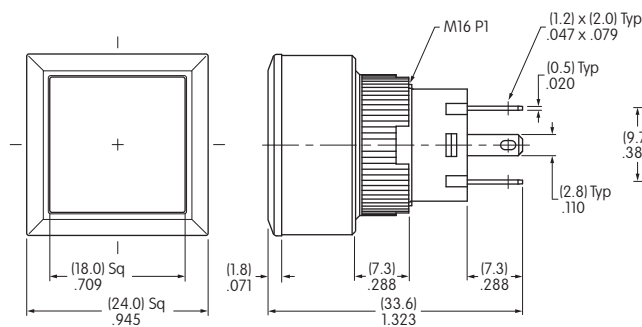

YB216CWSPW01-N-P

## PANEL THICKNESS & CUTOUT

Recommended Panel Thickness  
.020" ~ .197"  
(0.5mm ~ 5.0mm)

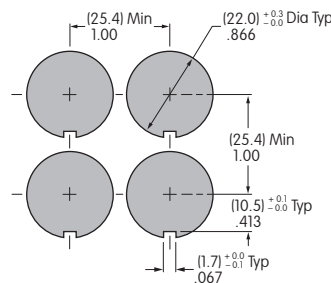

Side-by-side Mounting

Recommended Panel Thickness  
.020" ~ .197"  
(0.5mm ~ 5.0mm)

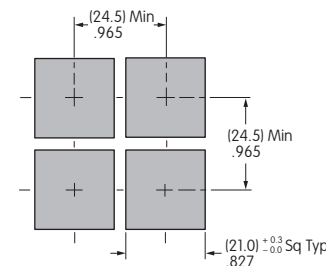

Side-by-side Mounting

OPTIONAL ACCESSORIES

Adaptors

**AT716**  
Single Pole  
Solder Lug/  
Quick Connect  
Terminals

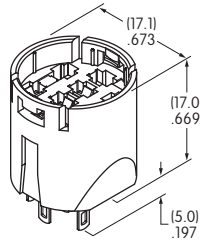
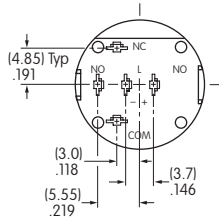

**AT717**  
Double Pole  
Solder Lug/  
Quick Connect  
Terminals

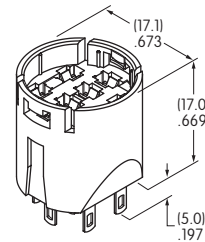
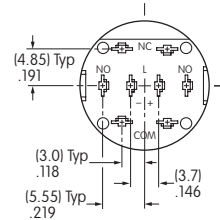

**AT718**  
Single Pole  
Straight PC  
Terminals

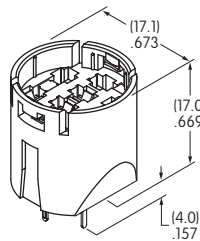
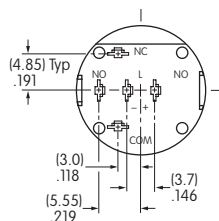

**AT719**  
Double Pole  
Straight PC  
Terminals

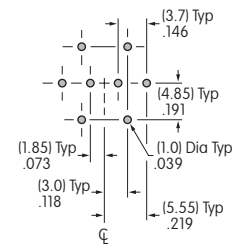
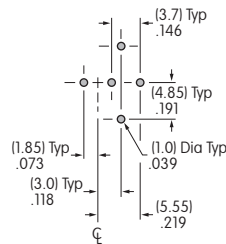
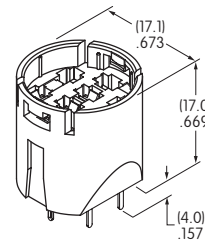
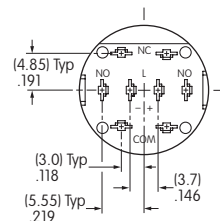

Material: Glass fiber reinforced polyamide      Note: Order adaptors separately

Round & Square Switch Dimensions Shown with Adaptor AT716

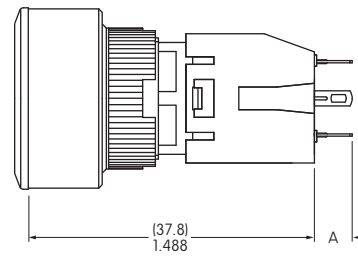
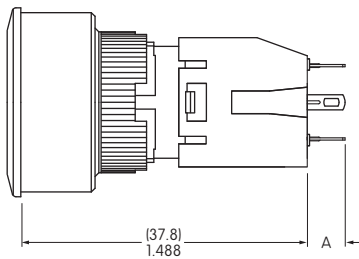

Dimension A:

Solder Lug .197" (5.0mm); Straight PC .157" (4.0mm)

Panel thickness for YB2 Round:  
.020" ~ .161" (0.5mm ~ 4.1mm)

Panel thickness for YB2 Square:  
.020" ~ .126" (0.5mm ~ 3.2mm)

- Toggle
- Rockers
- Pushbuttons
- Illuminated PB**
- Programmable
- Keylocks
- Rotaries
- Slides
- Tactiles
- Tilt
- Touch
- Indicators
- Accessories
- Supplement

## ASSEMBLY INSTRUCTIONS FOR ROUND

1. Remove knurled mounting nut.

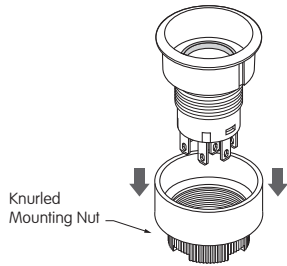

5. Install the red o-ring which was removed in step 2 at the inside bottom of the bezel.

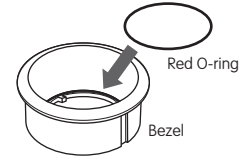

2. Remove bezel and red o-ring from housing. There are two o-rings in this assembly: one is red, one is orange.

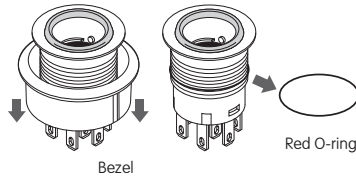

6. Align tab inside of the bezel with keyway on housing and bring bezel back into its original position.

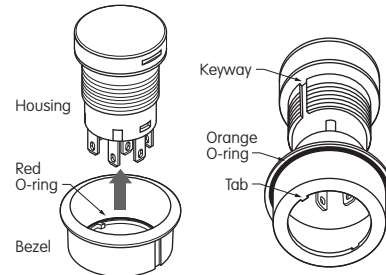

3. Install LED.

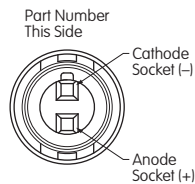

7. Before installing into panel, make sure that the orange o-ring is present at the back of the bezel. Align keyway on bezel with tab in panel and push switch all the way into the panel.

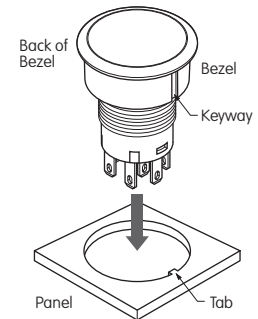

LEDs  
AT634 & AT636

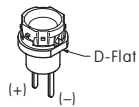

Align D-flat on LED with Part Number on switch for appropriate polarity and insert LED into base.

LED AT628

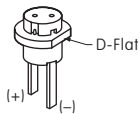

Align D-flat on LED with Part Number on switch for appropriate polarity and insert LED into base.



LEDs AT625G,  
AT631B,  
AT632F

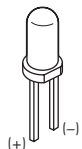

The larger metal part within the LED represents the cathode (-). Align LED for appropriate polarity and insert LED into base.

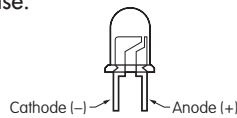

4. Align tabs (B) on both sides of actuator with the projections (A) inside of the housing and push actuator firmly down to snap in.

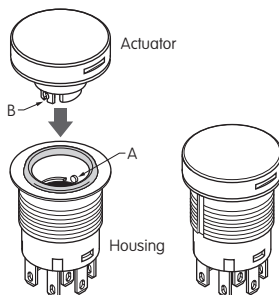

8. Attach mounting nut behind panel and tighten. Make sure that bezel and actuator fit properly and that there is no space between bezel and panel. Do not overtighten.

Mounting torque: 0.785Nm (6.95 lb•in) maximum.  
Optional socket wrench AT106 available.

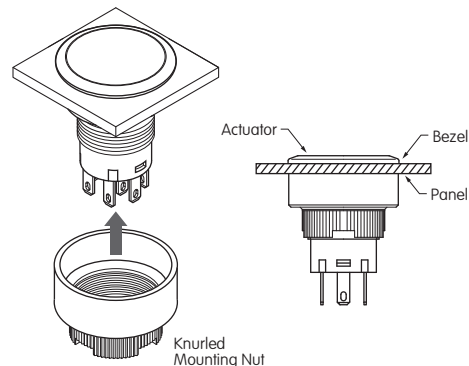

AT106 Socket Wrench



## ASSEMBLY INSTRUCTIONS FOR SQUARE

1. Remove knurled mounting nut.

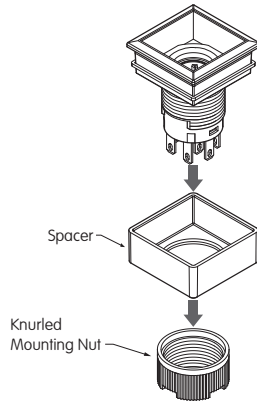

2. Remove bezel and blue o-ring from housing.

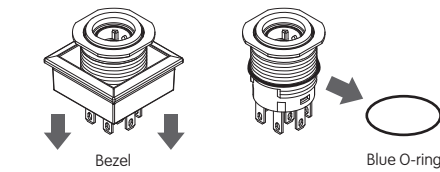

3. Install LED.

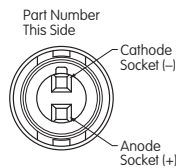

LEDs  
AT634 & AT636

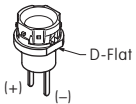

Align D-flat on LED with Part Number on switch for appropriate polarity and insert LED into base.



LED AT628

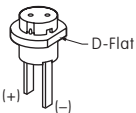

Align D-flat on LED with Part Number on switch for appropriate polarity and insert LED into base.



LEDs AT625G,  
AT631B,  
AT632F

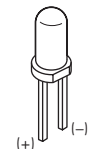

The larger metal part within the LED represents the cathode (-). Align LED for appropriate polarity and insert LED into base.

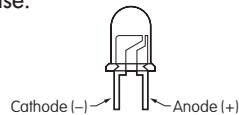

4. Align tabs (B) on both sides of actuator with the projections (A) inside of the housing and push actuator firmly down to snap in.

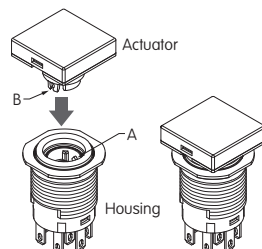

5. Install the blue o-ring which was removed in step 2 at the inside bottom of the bezel.

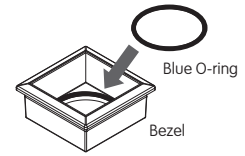

6. Align tab inside of the bezel with keyway on housing and bring bezel back into its original position.

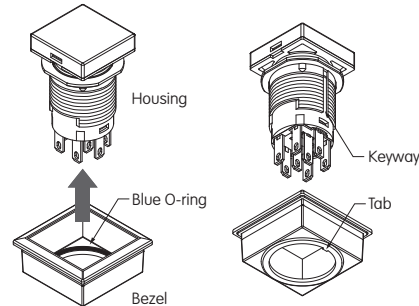

7. Before installing into panel, make sure that the square gasket is present at the back of the bezel. Align keyway on bezel with tab in panel and push switch all the way into the panel.

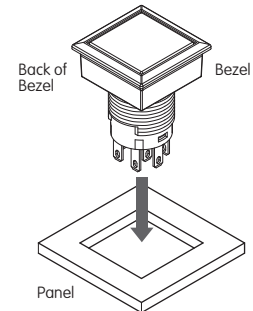

8. Attach mounting nut behind panel and tighten. Make sure that bezel and actuator fit properly and that there is no space between bezel and panel. Do not overtighten.

Mounting torque: 0.785Nm (6.95 lb•in) maximum.  
Optional socket wrench AT106 available.

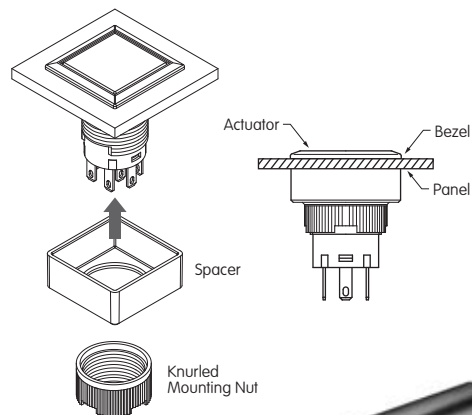

AT106 Socket Wrench



Toggles

Rockers

Pushbuttons

Illuminated PB

Programmable

Keylocks

Rotaries

Slides

Tactiles

Tilt

Touch

Indicators

Accessories

Supplement

## LEGENDS

NKK Switches can provide custom legends for caps. Contact factory for more information.

### Suggested Printable Area for YB2 Caps

**Recommended Methods:** Laser Etch on clear cap, Screen Print or Pad Print on cap.  
Epoxy based ink is recommended.

For Caps  
AT3017, AT3018, and AT3019

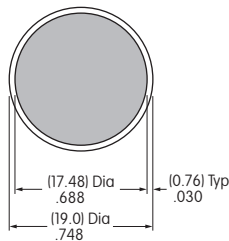

For Cap  
AT3020 (with clear ring for illumination)

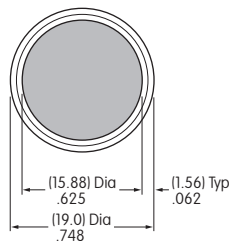

For Caps  
AT3025 and AT3027

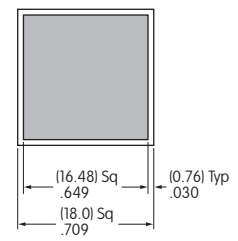

Shaded areas are printable areas.

### Suggested Printable Area for Film Inserts

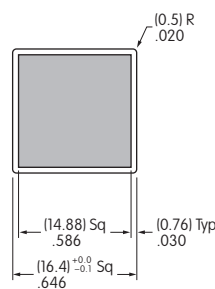
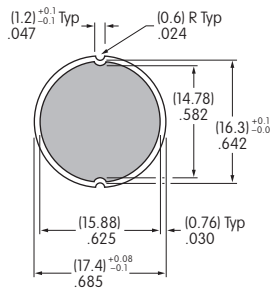

#### Recommended Method:

Screen Print; Epoxy based ink is recommended

#### Film Material and Thickness:

Clear Polyester, 4 mil max.

Shaded areas are printable areas.

## HANDLING & PRECAUTIONS



LEDs are electrostatic sensitive devices. When installing and handling LEDs, use an electrostatic protected work station to prevent LED damage.

# Mouser Electronics

Authorized Distributor

Click to View Pricing, Inventory, Delivery & Lifecycle Information:

## NKK Switches:

[YB26WRKW01-12-GB](#) [YB25NKW01-12-EB](#) [YB26WSKW03-6B-JB](#) [YB26WSKG01-12-FB](#) [YB26WRKW01-2CF05-JB](#)  
[YB26RKW01-5C12-JB](#) [YB26WSKW01-5C12-JC-RO](#) [YB26WSKW01-28-JB](#) [YB215CWCKG01-5D24-EB](#)  
[YB215CWCKG01/CUL-5D24-EB](#) [YB216CWCKW01/CUL-5F05-FB](#) [YB215CWCSW01-5F12-JB](#)  
[YB215CWCKW01/CUL-6G-JB](#) [YB25CKW01-5D24-JB](#) [YB25WSKW01-5D-JB-RO](#) [YB215CWCKW01/CUL-N-CB](#)  
[YB215CWCKW01-5C12-CB](#) [YB215CWCSG01](#) [YB215CWCSG01/CUL-N-S](#) [YB215CWCSG01-N-FB](#)  
[YB215CWCSW01-N-JB](#) [YB225CWCSW01-N-JB](#) [YB215CWCSW01-5F24-FB](#) [YB25WSKW01-5F-JF-RO](#)  
[YB25WCKW01-5D-JD-RO](#) [YB25WCKW01-5C-JC-RO](#) [YB25CKW01-12-BB](#) [YB26CKG01-5C-JB](#) [YB26WCKG01-5C12-](#)  
[JB](#) [YB215CWCKW01/CUL-5D-JB](#) [YB225CWCKW01/CUL-5D-JB](#) [YB215CWCKW01/CUL-5C-CB](#)  
[YB215CWCKW01/CUL-5C-JB](#) [YB216CWCKW01/CUL-5D-JB](#) [YB226CWCKW01/CUL-5D-JB](#) [YB216CWCKW01/CUL-](#)  
[5D-EB](#) [YB225CWCKW01/CUL-5C-JB](#) [YB226CWCKW01/CUL-5D-EB](#) [YB216CWCKW01/CUL-5C-JB](#)  
[YB226CWCKW01-6F-JB](#) [YB226CWCKW01/CUL-6F-JB](#) [YB215CWCSG01-6F-JB](#) [YB215CWCSW01-6G-JB](#)  
[YB25WSKW01-1CF02-JB](#) [YB215CWCSW01-6B-JS](#) [YB215CWCKW01/CUL-5F12-FB](#) [YB215CWCSW01-6F-JS](#)  
[YB215CWCKW01/CUL-6B-JB](#) [YB216CWCSW01-5F05-FB](#) [YB225CWCKW01/CUL-5F12-JB](#) [YB225CWCSW01-5D-JB](#)  
[YB215CWCKW01/CUL-5C-JS](#) [YB215CWCKW01/CUL-5D-JS](#) [YB215CWCKW01/CUL5F24FB](#)  
[YB216CWCKW01/CUL-5C-JS](#) [YB216CWCKW01/CUL-5D-JS](#) [YB225CWCKW01/CUL-5C-JS](#) [YB225CWCKW01/CUL-](#)  
[5D-JS](#) [YB225CWCKW01/CUL5F24FB](#) [YB215CWCKW01/CUL5C24CB](#) [YB215CWCKW01CUL5D24EB](#)  
[YB225CWCKW01/CUL5C24CB](#) [YB225CWCKW01CUL5D24EB](#) [YB216CWCSW015F12JS](#) [YB216CWCSG01-6B-JS](#)  
[YB216CWCSW01/CUL-5F05-JB](#) [YB226CWCSW01-5C12-CB](#) [YB226CWCSW01-5C24-CB](#) [YB226CWCSW01-N-S](#)  
[YB215CWCSG01-5F05-JB](#) [YB215CWCSG01-5F24-JB](#) [YB215CWCSW01-5C12-JB](#) [YB215CWCSW01-5D12-JB](#)  
[YB215CWCSW01-5D24-JB](#) [YB215CWCSW01-5F12-FB](#) [YB215CWCSW01-N-CB](#) [YB216CWCSW01-5F12-FB](#)  
[YB225CWCKW01/CUL-N-CB](#) [YB215X011](#) [YB226CWSKW01-JB](#) [YB225CWCSW01/CUL](#) [YB225CWCSW01/CUL-6B-](#)  
[JB](#) [YB225CWCSW01/CUL-6B-JS](#) [YB225CWCSW01/CUL-6G-JB](#) [YB225CWCSW01/CUL-6G-JS](#) [YB215CWCKG01-N-](#)  
[CB](#) [YB215CWCKW01-5F05-FB](#) [YB215CWCKW01-6G-JB](#) [YB215CWCKW01-N-JB](#) [YB215CWCSG01/CUL](#)  
[YB215CWCSW01](#) [YB215CWCSW01/CUL](#) [YB216CWCKW01/CUL-5C12-JS](#) [YB216CWCKW01/CUL-6B-JS](#)  
[YB216CWCSG01](#) [YB216CWCSG01/CUL](#) [YB216CWCSG01/CUL-5F05-JS](#) [YB216CWCSW01](#) [YB216CWCSW01/CUL](#)  
[YB216CWCSW01-5F24-JB](#)