

IEC Appliance Inlet C14 or C18 with Fuseholder 2-pole, Line Switch 1- or 2-pole



Order required accessories separately



KM with shield

Snap-in version



See below:  
[Approvals and Compliances](#)

**Description**

- Panel mount :  
 Snap-in version from front side
- 3 Functions :  
 Appliance Inlet protection class I or II , Line Switch 2-pole , Fuseholder for fuse-links 5 x 20 mm 1- or 2-pole
- Meets the requirements of IEC 60335-1 for appliances in unattended use. This includes the enhanced requirements of glow wire tests acc. to IEC 60695-2-12 and -13.
- Quick connect terminals 4.8 x 0.8 mm
- With cover on rear-side

**Characteristics**

- Ultra-compact design. Small dimensions in front of and behind the panel
- All single elements are already wired
- For added safety "Extra-Safe" fuse drawers are available
- Ideal for application with high transient loads
- Suitable for use in equipment according to IEC/UL 60950

**Other versions on request**

- Fuse drawer 1-pole, plus spare fuse case
- Fuse drawer 2-pole, with shorting bar
- Line switch 1-pole
- Other rocker marking

**References**

Alternative: version with line filter [KMF](#)  
 Alternative: version for screw mounting [DD11](#)

**Weblinks**

[pdf datasheet](#), [html-datasheet](#), [General Product Information](#), [Distributor-Stock-Check](#), [Accessories](#), [Detailed request for product](#)

**Technical Data**

Ratings IEC	10A / 250VAC; 50Hz	appliance inlet/-outlet	C14 / C18 acc. to IEC 60320-1, UL 60320-1, CSA C22.2 no. 60320-1 (for cold conditions) pin-temperature 70 °C, 10A, Protection Class I or II
Ratings UL/CSA	10A / 250VAC; 60Hz	Fuseholder	1 or 2 pole, Shocksafe category PC2 acc. to IEC 60127-6, UL 498, for fuse-links 5 x 20mm
Dielectric Strength	> 2.5 kVAC between L-N > 3 kVAC between L/N-PE (1 min/50Hz)	Rated Power Acceptance @ Ta 23 °C	5 x 20: 2W (1 pole)/ 1.6W (2-pole) per pole Choose fuse-links for 2-pole version in such a way that the typical power acceptance is less than 1.4 W for each pole
Allowable Operation Temperature	-25 °C to 70 °C	Power Acceptance @ Ta > 23°C	Admissible power acceptance at higher ambient temperature see derating curves
IP-Protection	from front side IP 40 acc. to IEC 60529	Line Switch	Rocker switch 2-pole, non-illuminated, acc. to IEC 61058-1 <a href="#">Technical Details</a>
Insulation cover	Suitable for appliances with protection class I or II acc. to IEC 61140		
Terminal	Quick connect terminals 4.8 x 0.8 mm , tin-plated		
Panel Thickness S	Snap-in: 1/1.5/2/2.5 mm (all steps with one variant)		
Material: Housing	Thermoplastic, black, UL 94V-0		

**Approvals and Compliances**



Detailed information on product approvals, code requirements, usage instructions and detailed test conditions can be looked up in [Details about Approvals](#)

SCHURTER products are designed for use in industrial environments. They have approvals from independent testing bodies according to national and international standards. Products with specific characteristics and requirements such as required in the automotive sector according to IATF 16949, medical technology according to ISO 134485 or in the aerospace industry can be offered exclusively with customer-specific, individual agreements by SCHURTER.

### Approvals





The approval mark is used by the testing authorities to certify compliance with the safety requirements placed on electronic products.

Approval Reference Type: KM

Approval Logo	Certificates	Certification Body	Description
	VDE Approvals	VDE	Certificate Number: 40046933
	UL Approvals	UL	UL File Number: E93617
	CQC Approvals	CQC	CCC Certificate Number: 2007010204227778, 2015180204000107



### Product standards

Product standards that are referenced

Organization	Design	Standard	Description
	Designed according to	IEC 60320-1	Appliance couplers for household and similar general purposes
	Designed according to	IEC 60127-6	Miniature fuses. Part 6. Fuse-holders for miniature fuse-links
	Designed according to	IEC 61058-1	Switches for appliances. Part 1. General requirements
	Designed according to	UL 60320-1	Standard for Attachment Plugs and Receptacles
	Designed according to	CSA C22.2 no. 60320-1	General Use Receptacles, Attachment Plugs, and Similar Wiring Devices







### Application standards

Application standards where the product can be used

Organization	Design	Standard	Description
	Designed for applications acc.	IEC/UL 60950	IEC 60950-1 includes the basic requirements for the safety of information technology equipment.
	Designed for applications acc.	IEC 60601-1	Medical electrical equipment - Part 1: General requirements for basic safety and essential performance
	Designed for applications acc.	IEC 60335-1	Safety of electrical appliances for household and similar purposes. Meets the requirements for appliances in unattended use. This includes the enhanced requirements of glow wire tests acc. to IEC 60695-2-12 and -13.

### Compliances

The product complies with following Guide Lines

Identification	Details	Initiator	Description
	CE declaration of conformity	SCHURTER AG	The CE marking declares that the product complies with the applicable requirements laid down in the harmonisation of Community legislation on its affixing in accordance with EU Regulation 765/2008.
	RoHS	SCHURTER AG	EU Directive RoHS 2011/65/EU
	China RoHS	SCHURTER AG	The law SJ / T 11363-2006 (China RoHS) has been in force since 1 March 2007. It is similar to the EU directive RoHS.
	REACH	SCHURTER AG	On 1 June 2007, Regulation (EC) No 1907/2006 on the Registration, Evaluation, Authorization and Restriction of Chemicals 1 (abbreviated as "REACH") entered into force.
	White paper Glow wire test	SCHURTER AG	Meets the requirements of IEC 60335-1 for appliances in unattended use. This includes the enhanced requirements of glow wire tests acc. to IEC 60695-2-12 and -13.
	Medical Equipment	SCHURTER AG	Suitable for use in medical equipment according to IEC/UL 60601-1

**Dimensions [mm]**

KM without shield

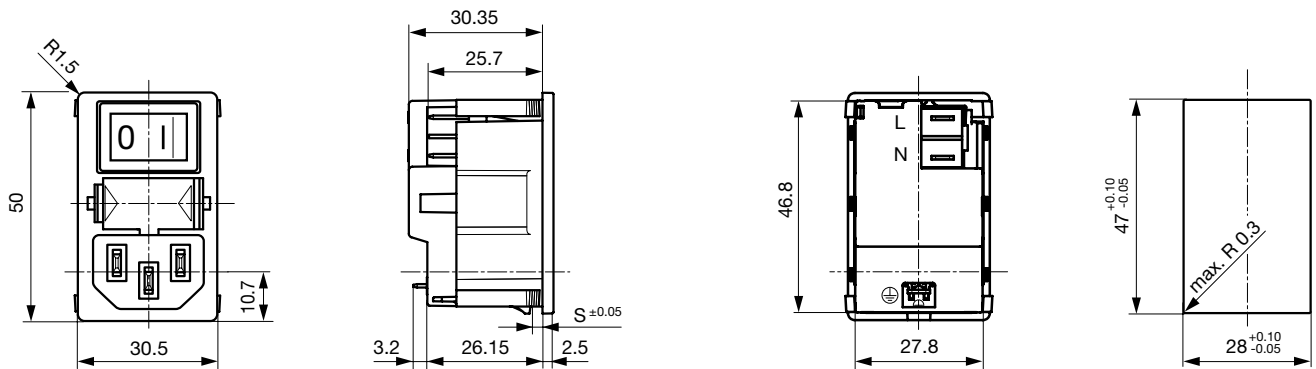

KM with shield

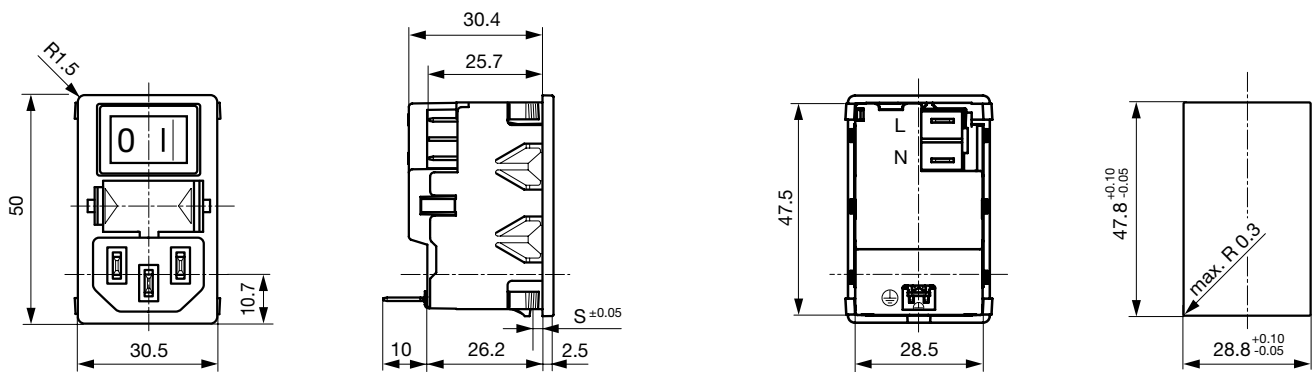

**Diagrams**

with shield

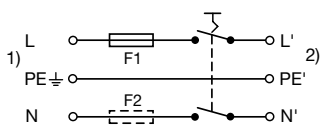

- 1) Line
- 2) Load

**Derating Curves**

1-pole

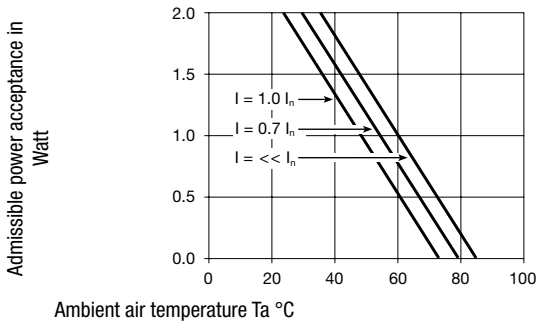

2-pole

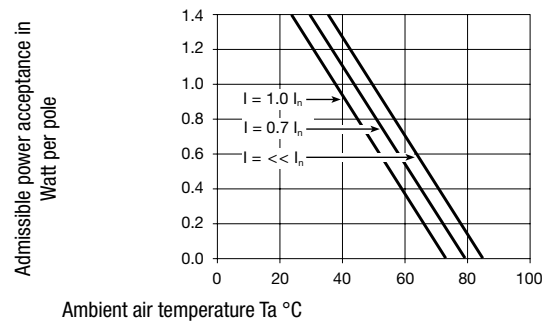

**All Variants**

Protection Class	Fuseholder	Line Switch	EMC-Shielding	Order Number
I	1-pole	2-pole	-	KM00.1205.11
I	2-pole	2-pole	-	KM00.1105.11
II	2-pole	2-pole	-	KM00.2105.11
I	1-pole	2-pole	With EMC-shield and without line filter	KM01.1205.11
I	2-pole	2-pole	With EMC-shield and without line filter	KM01.1105.11

Most Popular.

Availability for all products can be searched real-time: <https://www.schurter.com/en/Stock-Check/Stock-Check-SCHURTER>

**Packaging unit** 50 Pcs

**Required Accessory**

**Description**

Fusedrawer 2  
 Fusedrawer für Fuse Links 5x20 mm, with or without Voltage Selector Insert



Fingergrip, 2-pole	4301.1401
Extra-Safe, 2-pole	4301.1403
Fingergrip, 1-pole	4301.1405
Extra-Safe, 1-pole	4301.1407
...	...

Accessories



Wire Harness  
 Wire harness for SCHURTER products



Cord retaining kits  
 Cord retaining strain relief

Flat head, A	4700.0001
--------------	-----------

Mating Outlets/Connectors

Category / Description

Appliance Outlet Overview complete



IEC Appliance Outlet F, Screw-on Mounting, Front Side, Solder Terminal	4787
IEC Appliance Outlet F, Snap-in Mounting, Front Side, Solder or Quick-connect Terminal	4788
IEC Appliance Outlet F or H, Screw-on Mounting, Front Side, Solder, PCB or Quick-connect Terminal	5091

Appliance Outlet further types to KM

Connector Overview complete



4782 Mounting: Power Cord, 3 x 1 mm <sup>2</sup> / 3 x 18 AWG, Cable, Connector: IEC C13	4782
4785 Mounting: Power Cord, 3 x 1 mm <sup>2</sup> / 3 x 18 AWG, Cable, Connector: IEC C13	4785
4300-06 Mounting: Power Cord, 3 x 1 mm <sup>2</sup> / 3 x 18 AWG, Cable, Connector: IEC C13	4300-06
IEC Connector C15 for hot conditions 120°C, Rewireable, Straight	4781
IEC Connector C15 for hot conditions 120°C, Rewireable, Angled	4784

Connector further types to KM

# Mouser Electronics

Authorized Distributor

Click to View Pricing, Inventory, Delivery & Lifecycle Information:

Schurter:

[KM01.1205.11](#) [KM01.1105.11](#) [KM00.1205.11](#) [KM00.1105.11](#) [KM00.1105.1101](#) [KM00.1105.1102](#) [KM00.2105.11](#)