

High Voltage IGBT

IXGH 10N170A
IXGT 10N170A

$V_{CES} = 1700 \text{ V}$
 $I_{C25} = 10 \text{ A}$
 $V_{CE(sat)} = 6.0 \text{ V}$
 $t_{fi(typ)} = 35 \text{ ns}$

Preliminary Data Sheet

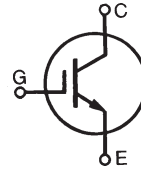

Symbol	Test Conditions	Maximum Ratings	
V_{CES}	$T_J = 25^\circ\text{C to } 150^\circ\text{C}$	1700	V
V_{CGR}	$T_J = 25^\circ\text{C to } 150^\circ\text{C}; R_{GE} = 1 \text{ M}\Omega$	1700	V
V_{GES}	Continuous	± 20	V
V_{GEM}	Transient	± 30	V
I_{C25}	$T_C = 25^\circ\text{C}$	10	A
I_{C90}	$T_C = 90^\circ\text{C}$	5	A
I_{CM}	$T_C = 25^\circ\text{C}, 1 \text{ ms}$	20	A
SSOA (RBSOA)	$V_{GE} = 15 \text{ V}, T_{VJ} = 125^\circ\text{C}, R_G = 22\Omega$ Clamped inductive load	$I_{CM} = 20$ @ $0.8 V_{CES}$	A
t_{SC}	$T_J = 125^\circ\text{C}, V_{CE} = 1200 \text{ V}; V_{GE} = 15 \text{ V}, R_G = 22\Omega$	10	μs
P_C	$T_C = 25^\circ\text{C}$	140	W
T_J		-55 ... +150	$^\circ\text{C}$
T_{JM}		150	$^\circ\text{C}$
T_{stg}		-55 ... +150	$^\circ\text{C}$
M_d	Mounting torque (M3) (TO-247)	1.13/10Nm/lb.in.	
Maximum lead temperature for soldering 1.6 mm (0.062 in.) from case for 10 s		300	$^\circ\text{C}$
Weight		TO-247 TO-268	6 4 g

TO-268 (IXGT)

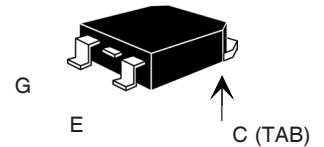

TO-247 AD (IXGH)

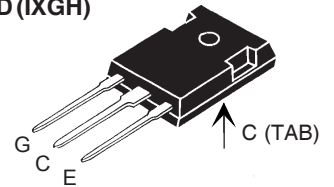

G = Gate, C = Collector,
E = Emitter, TAB = Collector

Features

- International standard packages JEDEC TO-268 and JEDEC TO-247 AD
- High current handling capability
- Very high frequency
- MOS Gate turn-on - drive simplicity
- Rugged NPT structure
- Molding epoxies meet UL 94 V-0 flammability classification

Applications

- Pulsar circuits
- AC motor speed control
- DC servo and robot drives
- DC choppers
- Uninterruptible power supplies (UPS)
- Switched-mode and resonant-mode power supplies

Advantages

- High power density
- Suitable for surface mounting
- Easy to mount with 1 screw, (isolated mounting screw hole)

Symbol	Test Conditions	Characteristic Values ($T_J = 25^\circ\text{C}$, unless otherwise specified)		
		min.	typ.	max.
BV_{CES}	$I_C = 250 \mu\text{A}, V_{GE} = 0 \text{ V}$	1700		V
$V_{GE(th)}$	$I_C = 250 \mu\text{A}, V_{CE} = V_{GE}$	3.0		V
I_{CES}	$V_{CE} = 0.8 \cdot V_{CES}$ $V_{GE} = 0 \text{ V}$		$T_J = 25^\circ\text{C}$ $T_J = 125^\circ\text{C}$	25 500 μA
I_{GES}	$V_{CE} = 0 \text{ V}, V_{GE} = \pm 20 \text{ V}$			$\pm 100 \text{ nA}$
$V_{CE(sat)}$	$I_C = I_{C90}, V_{GE} = 15 \text{ V}$	$T_J = 25^\circ\text{C}$ $T_J = 125^\circ\text{C}$	4.5 5.2	V V

Symbol	Test Conditions	Characteristic Values ($T_J = 25^\circ\text{C}$, unless otherwise specified)		
		min.	typ.	max.
g_{fs}	$I_C = I_{C25}; V_{CE} = 20\text{ V}$ Note 2	3	5	S
C_{ies}	$V_{CE} = 25\text{ V}, V_{GE} = 0\text{ V}, f = 1\text{ MHz}$		650	pF
C_{oes}			40	pF
C_{res}			22	pF
Q_G	$I_C = I_{C90}; V_{GE} = 15\text{ V}, V_{CE} = 0.5 V_{CES}$		29	nC
Q_{GE}			5	nC
Q_{GC}			10	nC
$t_{d(on)}$	Inductive load, $T_J = 25^\circ\text{C}$ $I_C = I_{C25}, V_{GE} = 15\text{ V}$ $R_G = 22\ \Omega, V_{CE} = 0.5 V_{CES}$		46	ns
t_{ri}			57	ns
$t_{d(off)}$			190	360 ns
t_{fi}			35	ns
E_{off}			0.38	0.8 mJ
$t_{d(on)}$	Inductive load, $T_J = 125^\circ\text{C}$ $I_C = I_{C25}, V_{GE} = 15\text{ V}$ $R_G = 22\ \Omega, V_{CE} = 0.5 V_{CES}$		48	ns
t_{ri}			59	ns
E_{on}			1.2	mJ
$t_{d(off)}$			200	ns
t_{fi}			40	ns
E_{off}		0.6	mJ	
R_{thJC}	(TO-247)			0.89 K/W
R_{thCK}			0.25	K/W

Notes: 1. Device must be heatsunk for high temperature leakage current measurements to avoid thermal runaway.

2. Pulse test, $t \leq 300\ \mu\text{s}$, duty cycle $\leq 2\%$

TO-247 AD Outline

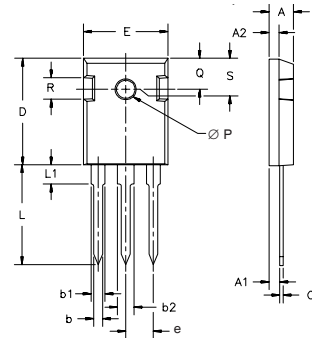

Dim.	Millimeter		Inches	
	Min.	Max.	Min.	Max.
A	4.7	5.3	.185	.209
A ₁	2.2	2.54	.087	.102
A ₂	2.2	2.6	.059	.098
b	1.0	1.4	.040	.055
b ₁	1.65	2.13	.065	.084
b ₂	2.87	3.12	.113	.123
C	.4	.8	.016	.031
D	20.80	21.46	.819	.845
E	15.75	16.26	.610	.640
e	5.20	5.72	0.205	0.225
L	19.81	20.32	.780	.800
L1		4.50		.177
∅P	3.55	3.65	.140	.144
Q	5.89	6.40	0.232	0.252
R	4.32	5.49	.170	.216
S	6.15	BSC	.242	BSC

TO-268 Outline

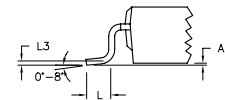
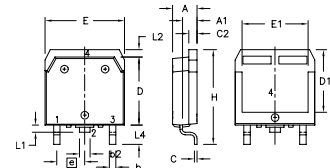

Dim.	Millimeter		Inches	
	Min.	Max.	Min.	Max.
A	4.9	5.1	.193	.201
A ₁	2.7	2.9	.106	.114
A ₂	.02	.25	.001	.010
b	1.15	1.45	.045	.057
b ₂	1.9	2.1	.75	.83
C	.4	.65	.016	.026
D	13.80	14.00	.543	.551
E	15.85	16.05	.624	.632
E ₁	13.3	13.6	.524	.535
e	5.45	BSC	.215	BSC
H	18.70	19.10	.736	.752
L	2.40	2.70	.094	.106
L1	1.20	1.40	.047	.055
L2	1.00	1.15	.039	.045
L3		0.25 BSC		.010 BSC
L4	3.80	4.10	.150	.161

IXYS reserves the right to change limits, test conditions, and dimensions.

Fig. 1. Output Characteristics
@ 25 Deg. C

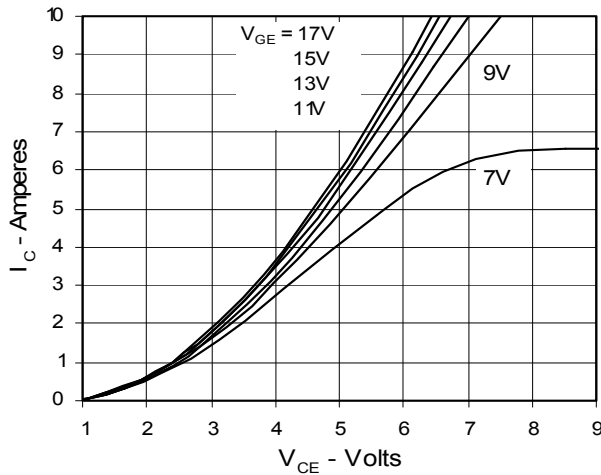

Fig. 2. Extended Output Characteristics
@ 25 deg. C

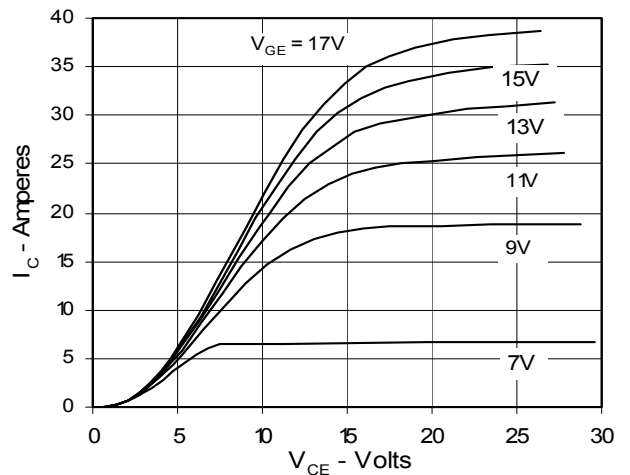

Fig. 3. Output Characteristics
@ 125 Deg. C

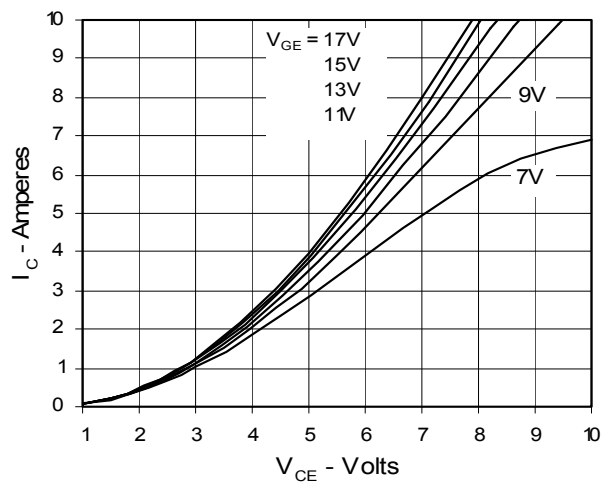

Fig. 4. Temperature Dependence of $V_{CE(sat)}$

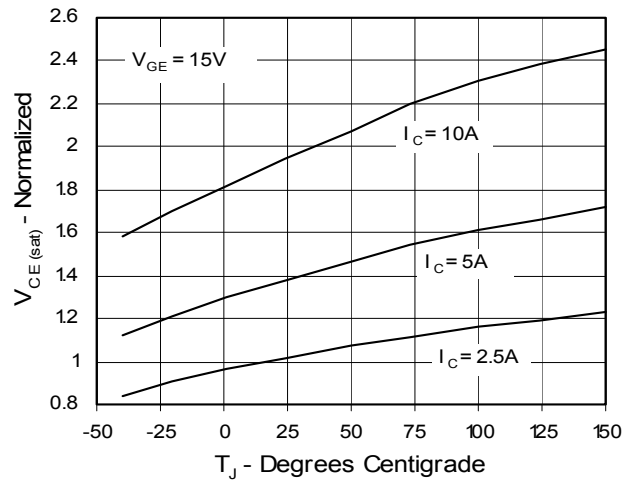

Fig. 5. Collector-to-Emitter Voltage vs. Gate-to-Emitter voltage

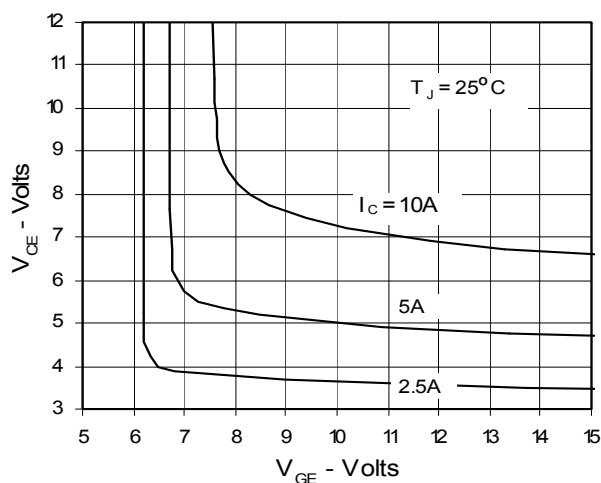

Fig. 6. Input Admittance

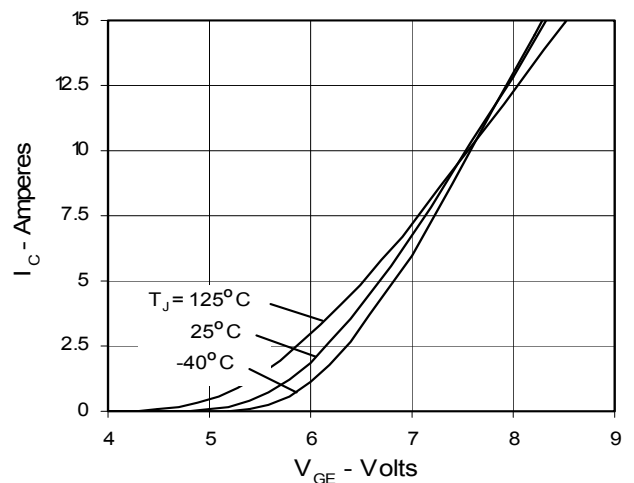

Fig. 7. Transconductance

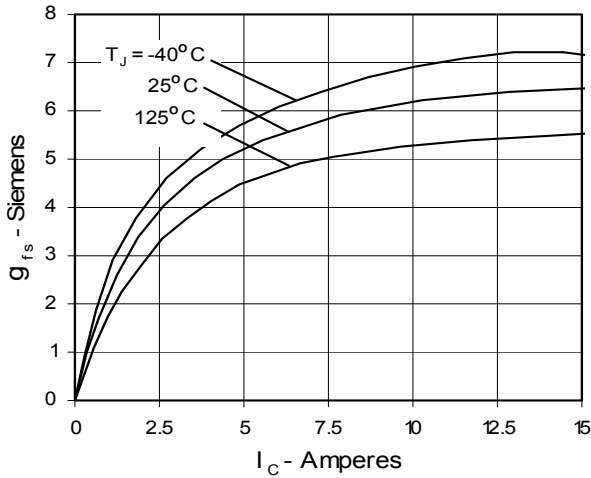

Fig. 8. Dependence of E_{off} on R_G

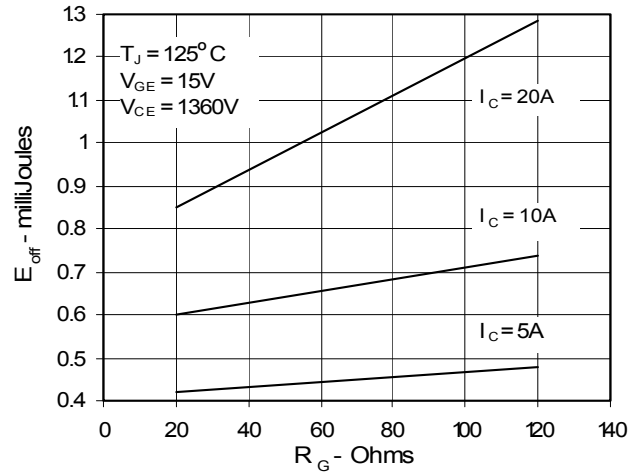

Fig. 9. Dependence of E_{off} on I_C

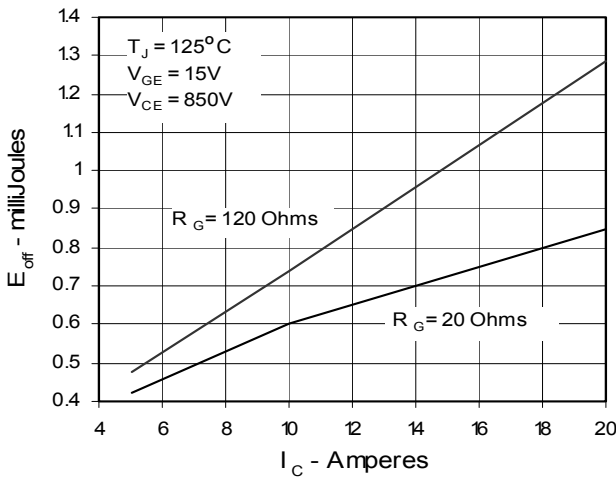

Fig. 10. Dependence of E_{off} on Temperature

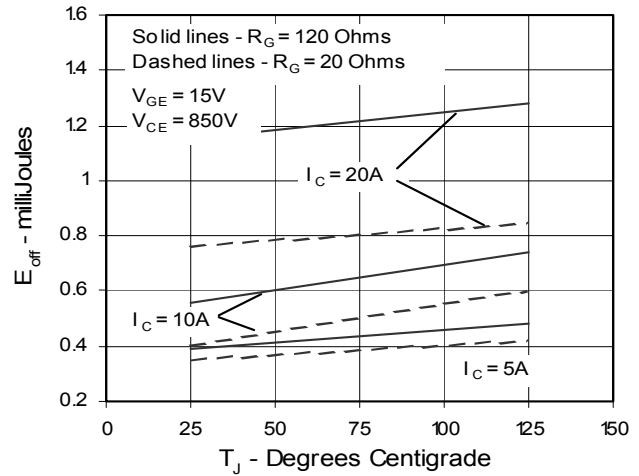

Fig. 11. Gate Charge

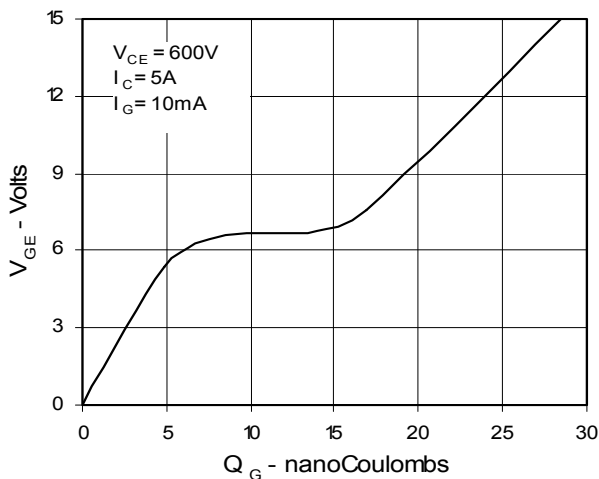
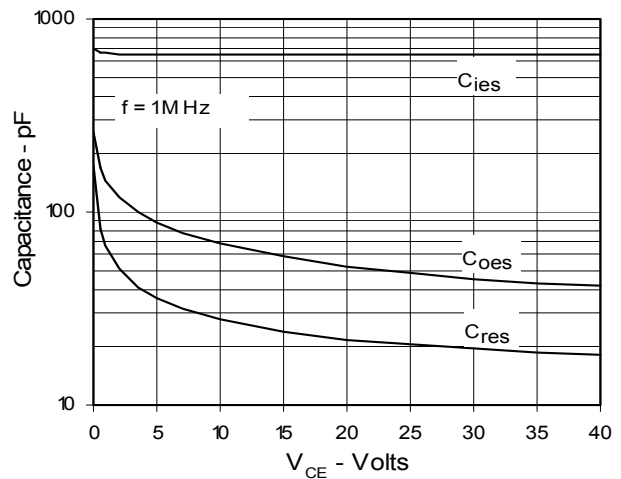
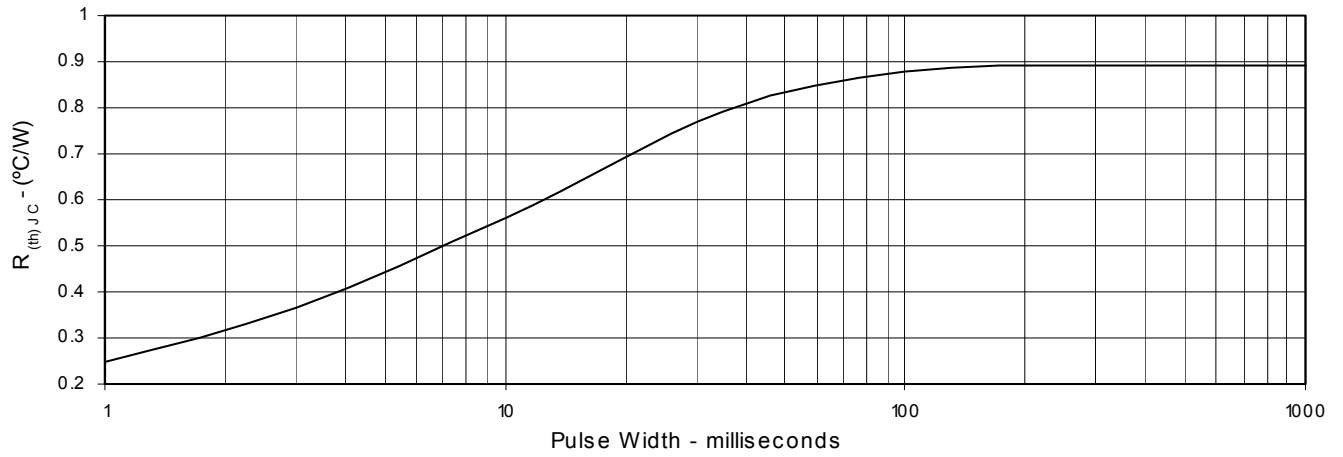

Fig. 12. Capacitance



IXYS reserves the right to change limits, test conditions, and dimensions.

Fig. 13. Maximum Transient Thermal Resistance



Mouser Electronics

Authorized Distributor

Click to View Pricing, Inventory, Delivery & Lifecycle Information:

[IXYS:](#)

[IXGH10N170A](#) [IXGT10N170A](#)