

PRODUCT NUMBER  
77311-YXX-XXLF

PLATING SEE SHEET 2  
PIN STYLE SEE SHEET 2

RoHS COMPATIBLE  
SEE NOTE 6

TOTAL NB OF POSITIONS 01 TO 36  
OPTION LETTER SEE NOTE 7

PRODUCT NUMBER (BERGSTRIK PACKAGING)  
77311-YXX-OOLF

PLATING

1= 0.76µm GOLD/GXT ON CONTACT AREA, 2µm TIN MIN ON TAILS

8= 0.38µm GOLD/GXT ON CONTACT AREA, 2µm TIN MIN ON TAILS

4= 2.0µm TIN MIN FULL PLATED

1.27µm NICKEL MIN UNDERLAYER FOR ALL PLATING VERSIONS

INDICATES THE PRODUCT IS RoHS COMPATIBLE, SEE NOTE 6

POSITIONS PER REEL : 00=36,000 (BERGSTRIK)

PIN STYLE	MATING	SOLDER	OAL
01	5.84	2.41	10.8
02	5.84	3.42	11.8
18	5.84	3.05	11.43
22	7.75	3.05	13.35
24	6.75	2.9	12.2
27	6.6	2.66	11.8

NOTES:

- HOUSING MAT'L : HIGH TEMPERATURE THERMOPLASTIC. UL94V-0 COLOR: BLACK
- PIN MATERIAL : PHOSPHOR BRONZE
- BERGSTIK PRODUCT PACKAGED IN POLYBAGS. BERGSTRIK PRODUCT PACKAGED PER REELS.
- 9N MIN RETENTION IN EITHER DIRECTION
- TO DETERMINE DIMENSIONS :  
N = NUMBER OF POSITIONS PER ROW  
EXAMPLE : 8 POS N x 2.54 = 20.32mm

6. RoHS COMPATIBLE PRODUCT SPECIFICATIONS

- PLATING:**
  - "LF" MEANS THE PRODUCT IS LEAD-FREE, 2µm MINIMUM MATTE TIN OVER 1.27µm MINIMUM NICKEL UNDERPLATE.
- MANUFACTURING PROCESS COMPATIBILITY**
  - THE HOUSING WILL WITHSTAND EXPOSURE TO 260°C ±5°C SOLDER BATH TEMPERATURE FOR 5 SECONDS IN A WAVE SOLDER APPLICATION WITH A 1.6mm MIN THICK CIRCUIT BOARD.
  - REFLOW COMPATIBLE
- LABELING:**
  - MEETS PACKAGING SPECS AS PER GS-14-920
- LEGAL STATEMENT:** SEE GS-47-0004

7. OPTIONS : - = POLYBAG PACKAGING

- T = TUBE PACKAGING WITHOUT PICK UP CAP
- K = TAPE & REEL PACKAGING, WITHOUT PICK UP CAP ONLY FOR P/N 77311-462K04(LF) AND 77311-462K05(LF)
- KC = TAPE & REEL PACKAGING WITHOUT PICK UP CAP AND WITH HIGH RETENTION FEATURES
- KV = TAPE & REEL PACKAGING WITHOUT PICK UP CAP FOR CUSTOMER DEDICATED PART ONLY FOR P/N 77311-462KV04LF
- C = HIGH RETENTION FEATURES, SEE SHEET 2
- R = RETENTION FEATURES, SEE SHEET 2 IF RETENTION FEATURE "R" AND TUBE PACKAGING "T" ARE BOTH REQUIRED OPTIONAL LETTER "R" WILL APPEAR INSTEAD OF THE FIRST DASH EXAMPLE : 77311R424T03LF
- V = BLIBOX PACKAGING FOR CUSTOMER DEDICATED PART. ONLY FOR 77311-4BNV01LF

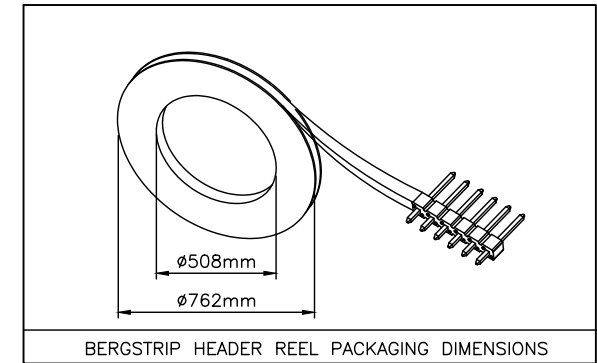
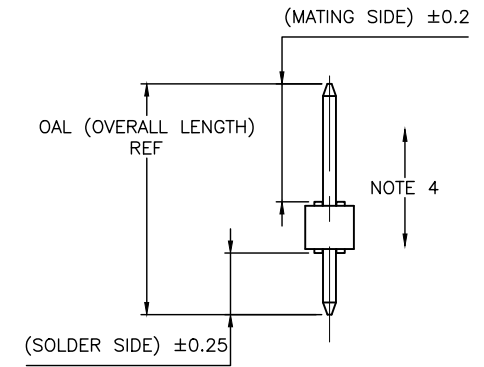
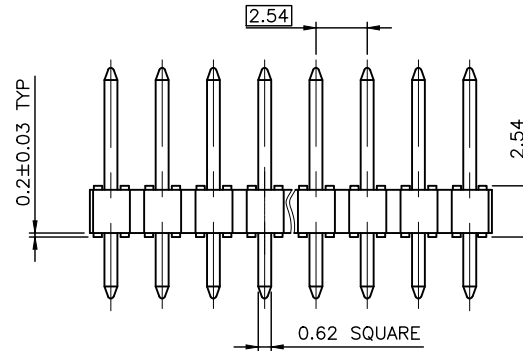
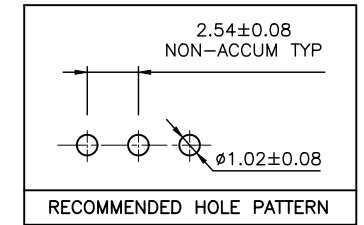
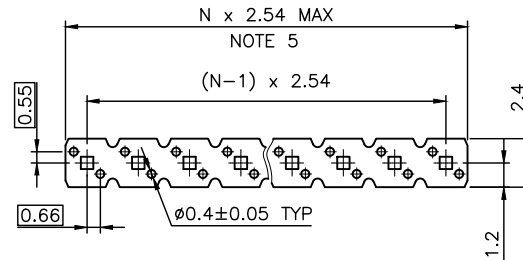

mat'l. code		surface		tolerance		projection		product family	
SEE NOTES		ISO 1302		ISO 406 ISO 1101		mm		BERGSTIK	
ltr	ecn no	dr	date	tolerances unless otherwise specified		mm		title	
CN	F-26241	LMU	17.03.01	angles	linear	.x ± 0.3		UNSHR.HEADER	
CP	F-28243	DDE	17.09.21			.xx ± 0.15		STR SR TMT	
CR	F-28445	DDE	17.11.10			.xxx ± 0.05		scale 5:1	
CS	F-29484	DDE	18.03.08	dr	D.LE	01.01.24		dwg no	
CT	F-31328	LMU	18.09.20	engr	JM.C	01.01.24		sheet 1 of 3 size	
				chr	JM.C	01.01.24		77311	
CM	F-25890	LMU	17.01.11	appd	JF.N	01.01.24		A3	
sheet	revision	CT	BX	J				type CUSTOMER Drawing	
index	sheet	1	2	3					

1

2 3

4

5

6

PLATING

1 = 0.76 $\mu$ m GOLD/GXT ON CONTACT AREA, 2 $\mu$ m TIN MIN ON TAIL  
 4 = 2 $\mu$ m TIN MIN FULL PLATED  
 5 = 0.25 $\mu$ m GOLD/GXT ON CONTACT AREA, 2 $\mu$ m TIN MIN ON TAIL  
 8 = 0.38 $\mu$ m GOLD/GXT ON CONTACT AREA, 2 $\mu$ m TIN MIN ON TAIL  
 G = 0.76 $\mu$ m FULL GXT  
 S = 0.38 $\mu$ m FULL GXT  
 T = 2 $\mu$ m TIN MIN FULL PLATED INCLUDED PIN TYP  
 - 1.27 $\mu$ m NICKEL MIN UNDERLAYER FOR ALL PLATING VERSIONS

RETENTION FEATURES :

1 - PART NUMBER 77311-XXXXXXLF: DIM "Z"=(0.99)  
 PART NUMBER 77311-XXXXCXXLF: DIM "Z"= 1.05MIN -1.15MAX  
 2 - PINS "A" AND "B" USED FOR RETENTION.  
 3 - DIRECTION OF RETENTION SHOWN BY ARROWS.  
 4 - ON 4 TO 36 POSITIONS HEADER; RETENTION IS IN MID POSITION OF HEADER (4 CENTRAL PINS)  
 5 - FOR RETENTION OPTION , SOLDER TAIL LENGTH TO BE 2.9 MIN UP TO 3.5 MAX.  
 6 - HOUSING MATERIAL FOR P/N 77311-4AJC03LF & 77311-TAJC03LF HIGH TEMPERATURE THERMOPLASTIC UL94V-0 COLOR : NATURAL

PLATING SPECIFICATIONS :

7 - ONLY FOR PLATING 1XX, 8.0MM GOLD / GXT PLATING AREA FROM PIN TYPE ON MATING SIDE

RETENTION FEATURES

1.7 REF  
 DIM "Z"  
 SEE NOTE 1

Amphenol  
FCI  
FCIconnect.com

Copyright FCI

mat'l. code		surface		tolerance		projection		product family	
		ISO 1302		ISO 406 ISO 1101				BERGSTIK	
ltr	ecn no	dr	date	tolerances unless otherwise specified		mm		title	
BU	B-20596	AMA	15.03.30					UNSHR.HEADER	
BV	F-22085	LMU	15.10.05	angles	linear			STR SR TMT	
BW	F-22100	AMA	15.10.08			scale N/A		dwg no	
BX	F-26241	LMU	17.03.01	dr	D.LE	01.01.24	sheet 2 of 3		size
				engr	JM.C	01.01.24	77311		A3
BS	B-20169	BVE	15.02.12	chr	JM.C	01.01.24	CUSTOMER		Drawing
BT	B-20497	BVE	15.03.18	appd	JF.N	01.01.24			
sheet index	revision								
	sheet								

form: A3

1

2

PDS: Rev :CT

STATUS:Released

Printed: Nov 28, 2018

5

6

PRODUCTS SPECIFICATIONS

PIN STYLE	MATING	SOLDER	OAL
01	5.84	2.41	10.8
02	5.84	3.42	11.8
03	5.72	5.09	13.35
05	5.72	10.14	18.4
08	5.72	17.78	26.04
15	8.51	2.55	13.6
18	5.84	3.05	11.43
19	12.83	3.03	18.4
20	15.37	3.04	20.95
22	7.75	3.05	13.35
24	6.75	2.9	12.2
25	8.51	3.18	14.22
27	6.6	2.65	11.8
26	15.57	2.84	20.95
29	17.5	3.46	23.5
32	10.3	3.05	15.9
38	5.84	3.82	12.2
39	11.2	3.05	16.8
46	8.08	2.98	13.6
54	8.08	3.81	14.43
58	14.47	3.05	20.06
62	13.5	3.05	19.09
70	6.54	3.50	12.57
83	20.46	3.00	26.00
85	5.72	8.51	16.76
87	6.98	3.05	12.57
91	5.6	10.21	18.35
92	5.65	12.76	20.95
93	6.00	4.81	13.35
94	15.60	3.20	21.25
95	10.00	8.45	20.95
96	10.95	3.05	16.55
97	9.00	3.55	15.09
98	3.00	1.35	6.84
99	24.00	3.05	29.50
AA	5.72	15.24	23.50
AB	N/A		

NOTE 7



PRODUCTS SPECIFICATIONS

PIN STYLE	MATING	SOLDER	OAL
AC	7.21	3.05	12.80
AD	17.53	3.43	23.50
AE	4.99	2.80	10.33
AF	5.72	3.05	11.30
AG	5.84	4.95	13.33
AH	14.31	3.20	20.05
AJ	8.90	3.40	14.85
AK	25.06	3.00	30.80
AL	3.30	3.30	9.14
AM	9.26	3.05	14.85
AN	7.60	4.40	14.47
AP	7.80	3.30	13.60
AR	18.86	2.41	23.81
AS	11.91	1.45	15.90
AT	4.60	4.60	11.61
AU	12.10	3.10	17.70
AV	6.30	6.30	15.10
AW	9.16	1.80	13.50
AX	5.08	2.43	10.05
AY	7.49	3.47	13.50
BA	8.08	2.75	13.37
BB	10.80	2.15	15.50
BC	8.08	3.81	14.43
BD	10.10	2.16	14.80
BE	13.65	2.41	18.60
BF	2.54	5.32	10.40
BG	4.98	1.85	9.23
BH	4.69	2.41	9.50
BJ	7.21	6.15	15.90
BK	6.86	2.65	12.05
BL	17.70	3.25	23.50
BM	10.96	3.70	16.20
BN	19.46	3.00	25.00
BP	8.80	3.20	14.50
BR	19.46	4.00	26.00
BS	5.72	11.05	19.30

NOTE 6

Amphenol FCI FCconnect.com

Copyright FCI

mat'l. code		surface ISO 1302 <input checked="" type="checkbox"/> ISO 406 ISO 1101		tolerance tolerances unless otherwise specified		projection 		product family BERGSTIK	
ltr	ecn no	dr	date	angles	linear	mm 		title UNSHR.HEADER STR SR TMT	
H	F-29484	DDE	18.03.08			scale N/A		dwg no 77311	
J	F-31328	LMU	18.09.20					sheet 3 of 3 size A3	
D	F-25890	LMU	17.01.11	dr	A.MA	15.10.08		type CUSTOMER Drawing	
E	F-26241	LMU	17.03.01	enr	L.MU	15.10.08			
F	F-28243	DDE	17.09.21	chr	J.CO	15.10.08			
G	F-28445	DDE	17.11.10	appd	ASO	15.10.08			
sheet index	revision sheet								

Amphenol FCI