

4

3

2

1

THIS DRAWING IS UNPUBLISHED. RELEASED FOR PUBLICATION 2008
 © COPYRIGHT 2008 BY - ALL RIGHTS RESERVED.

LOC	DIST	REVISIONS				
P	LTR	DESCRIPTION	DATE	DWN	APVD	
E	B	BA1	REVISED PER ECO-11-005150	29MAR2011	RK HMR	

SERIES 36501J, 36501E AS SHOWN

- 1 TERMINAL WRAPAROUND: 0.007"(0.18mm) APPROX. ON BOTH ENDS
- 2 AVAILABLE IN 2 DIFFERENT SERIES
- 3 FOR FURTHER INFORMATION SEE DATA SHEET FOR 3650 SERIES-LOW INDUCTANCE,HIGH FREQUENCY CHIP INDUCTOR

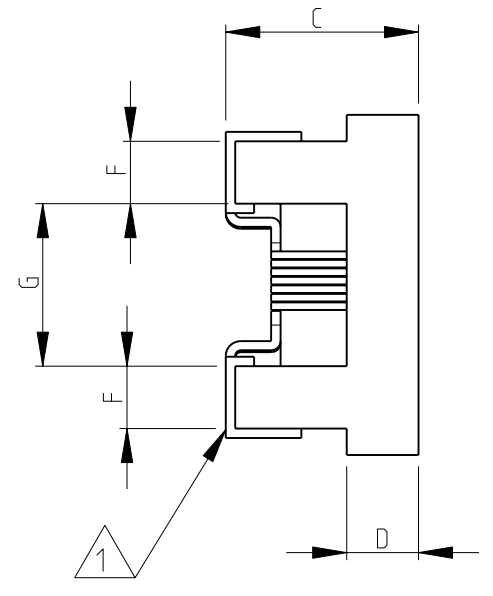
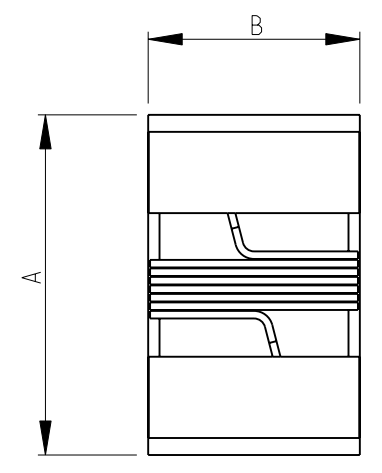

RoHS Compliant

RECOMMENDED LAND PATTERN FOR 36501J, 36501E SERIES



	A MAX.	B MAX.	C MAX.	D REF.	F	G	H	K	J
36501E	1.27	0.76	0.61	0.15	0.23	0.56	0.66	0.50	0.46
36501J	1.80	1.12	1.02	0.38	0.33	0.86	1.02	0.64	0.64

THIS DRAWING IS A CONTROLLED DOCUMENT.

DIMENSIONS: mm	TOLERANCES UNLESS OTHERWISE SPECIFIED:
	0 PLC ± 0.2
	1 PLC ± 0.1
	2 PLC ± -
	3 PLC ± -
	4 PLC ± -
	ANGLES ± 5°
MATERIAL -	FINISH -

DWN	SUBHASH.M	14-NOV-08
CHK	PRAKASH.S	14-NOV-08
APVD	STEPHEN.P	14-NOV-08
PRODUCT SPEC	-	-
APPLICATION SPEC	-	-
WEIGHT	-	-
CUSTOMER DRAWING		



LOW INDUCTANCE,
HIGH FREQUENCY CHIP
INDUCTOR SERIES 3650

SIZE	CAGE CODE	DRAWING NO	RESTRICTED TO
A3	00779	1624112	-
SCALE 20:1		SHEET 1 OF 1	REV BA1

Mouser Electronics

Authorized Distributor

Click to View Pricing, Inventory, Delivery & Lifecycle Information:

[TE Connectivity:](#)

[36501J4N7JTDG](#)