

Automotive 5 V low dropout voltage regulator

Datasheet - production data



- Early warning
- Very wide stability range with low value output capacitor
- Thermal shutdown and short-circuit protection
- Wide temperature range ($T_j = -40\text{ °C}$ to 150 °C)
- Enable input for enabling / disabling the voltage regulator

Features

Max DC supply voltage	V_S	40 V
Max output voltage tolerance	ΔV_o	$\pm 2\%$
Max dropout voltage	V_{dp}	500 mV
Output current	I_o	150 mA
Quiescent current	I_{qn}	$5\ \mu\text{A}^{(1)}$
		$55\ \mu\text{A}^{(2)}$

1. Typical value with regulator disabled.
2. Typical value with regulator enabled.

- AEC-Q100 qualified 
- Operating DC supply voltage range 5.6 V to 40 V
- Low dropout voltage
- Low quiescent current consumption
- Precision output voltage $5\text{ V} \pm 2\%$
- Reset circuit sensing the output voltage
- Programmable reset pulse delay with external capacitor
- Adjustable reset threshold

Description

L5150GJ is a low dropout linear regulator with microprocessor control functions such as power on reset, low voltage reset, early warning, on/off control. Typical quiescent current is $55\ \mu\text{A}$ in very low output current mode and enabled regulator. It drops to $5\ \mu\text{A}$ with not enabled regulator.

On chip trimming results in high output voltage accuracy ($\pm 2\%$). Accuracy is kept over wide temperature range, line and load variation. Early warning circuit monitors the input voltage and compares it with an internal voltage reference.

Output voltage reset threshold can be adjusted down to 3.5 V by means of an external voltage divider.

The maximum input voltage is 40 V. The max output current is internally limited. Internal temperature protection disables the voltage regulator output. In addition, only low-value ceramic capacitor on output is required for stability.

Table 1. Device summary

Package	Order codes	
	Tube	Tape & reel
PowerSSO-12	L5150GJ	L5150GJTR

Contents

- 1 Block diagram and pins description 5**

- 2 Electrical specifications 7**
 - 2.1 Absolute maximum ratings 7
 - 2.2 Thermal data 7
 - 2.3 Electrical characteristics 8
 - 2.4 Electrical characteristics curves 10

- 3 Application information 15**
 - 3.1 Voltage regulator 15
 - 3.2 Reset 17
 - 3.3 Early warning 19
 - 3.4 Enable 19

- 4 Package and PCB thermal data 20**
 - 4.1 PowerSSO-12 thermal data 20

- 5 Package information 23**
 - 5.1 PowerSSO-12 package information 23
 - 5.2 PowerSSO-12 packing information 25

- 6 Revision history 26**

List of tables

Table 1.	Device summary	1
Table 2.	Pins description	6
Table 3.	Absolute maximum ratings	7
Table 4.	Thermal data	7
Table 5.	General	8
Table 6.	Reset	9
Table 7.	Early warning	10
Table 8.	Enable.	10
Table 9.	PowerSSO-12 thermal parameter	22
Table 10.	PowerSSO-12 package mechanical data	24
Table 11.	Document revision history	26

List of figures

Figure 1.	Block diagram	5
Figure 2.	Configuration diagram (top view)	5
Figure 3.	Output voltage vs. T_j	10
Figure 4.	Output voltage vs. V_S	10
Figure 5.	Output voltage vs. V_{En}	11
Figure 6.	Drop voltage vs. output current	11
Figure 7.	Current consumption vs. output current	11
Figure 8.	Current consumption vs. output current (at light load condition)	11
Figure 9.	Current consumption vs. input voltage ($I_o = 0.1$ mA)	11
Figure 10.	Current consumption vs. input voltage ($I_o = 75$ mA)	11
Figure 11.	Current limitation vs. T_j	12
Figure 12.	Current limitation vs. input voltage	12
Figure 13.	Short-circuit current vs. T_j	12
Figure 14.	Short-circuit current vs. input voltage	12
Figure 15.	V_{En_high} vs. T_j	12
Figure 16.	V_{En_low} vs. T_j	12
Figure 17.	V_{Rhth} vs. T_j	13
Figure 18.	V_{Rlth} vs. T_j	13
Figure 19.	V_{EWi_thh} vs. T_j	13
Figure 20.	V_{EWi_thl} vs. T_j	13
Figure 21.	I_{cr} vs. T_j	13
Figure 22.	I_{dr} vs. T_j	13
Figure 23.	PSRR	14
Figure 24.	Application schematic	15
Figure 25.	Stability region	16
Figure 26.	Maximum load variation response	16
Figure 27.	Reset time diagram	18
Figure 28.	Early warning time diagram	19
Figure 29.	PowerSSO-12 PC board	20
Figure 30.	$R_{thj-amb}$ vs PCB copper area in open box free air condition	20
Figure 31.	PowerSSO-12 thermal impedance junction ambient single pulse	21
Figure 32.	Thermal fitting model of V_{reg} in PowerSSO-12	21
Figure 33.	PowerSSO-12 package outline	23
Figure 34.	PowerSSO-12 tube shipment (no suffix)	25
Figure 35.	PowerSSO-12 tape and reel shipment (suffix "TR")	25

1 Block diagram and pins description

Figure 1. Block diagram

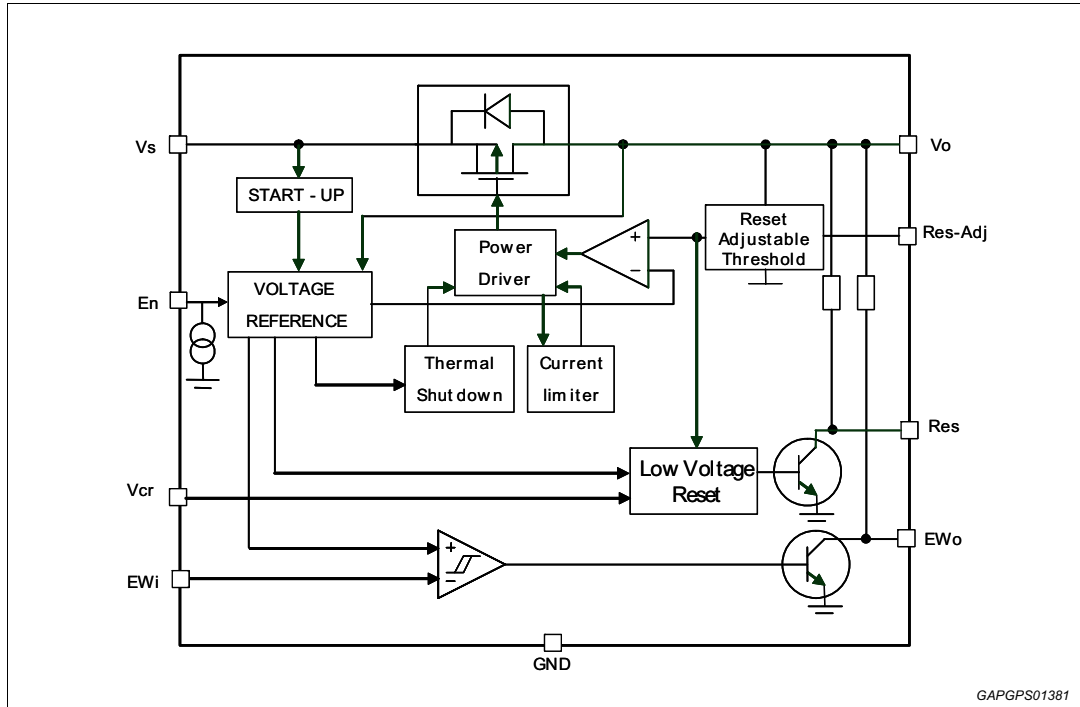

GAPGPS01381

Figure 2. Configuration diagram (top view)

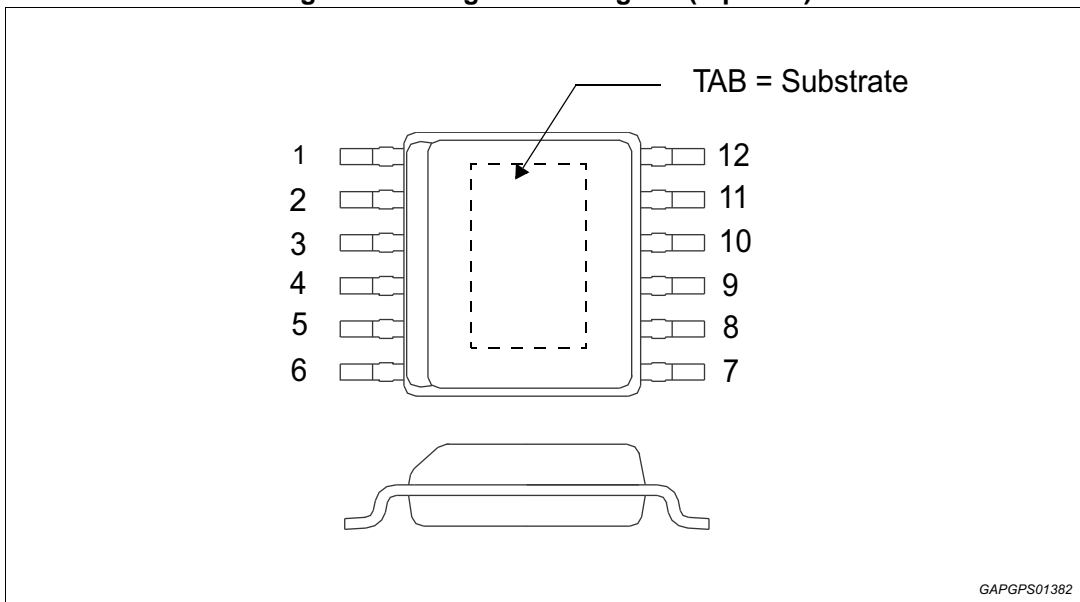

GAPGPS01382

Table 2. Pins description

Pin	Name	Function
1	R _{es_Adj}	Reset adjustable threshold. Connected to an appropriate external voltage divider, it allows to properly set the reset threshold down to 3.5 V. Connect to GND if not needed.
2	R _{es}	Reset output. Internally connected to V _o through a 20 K Ω pull-up resistor. This pin is pulled low when V _o < V _{o_th} . Keep open if not needed.
3	V _{cr}	Reset delay. Connect an external capacitor between V _{cr} pin and ground to adjust the reset delay time. Keep open if not needed.
4	GND	Ground reference.
5	NC	Not connected.
6	V _o	5 V regulated output. Block to GND with a ceramic capacitor (C _o \geq 220 nF for regulator stability).
7	V _S	Supply voltage, block directly to GND on the IC with a capacitor.
8	NC	Not connected.
9	E _n	Enable input. A high signal switches the regulator on. Connect to V _S if not needed.
10	EW _i	Early warning input. This pin monitors the V _S voltage level through a resistor divider. Connect to V _S if not needed.
11	NC	Not connected.
12	EW _o	Early warning output. Internally connected to V _o through 20 K Ω pull up resistor. This pin is pulled low when EW _i is below bandgap reference voltage. Keep open if not needed.
-	TAB	TAB is connected to the substrate of the chip: connect to GND or leave open (see Figure 2).

2 Electrical specifications

2.1 Absolute maximum ratings

Stressing the device above the rating listed in the [Table 3: Absolute maximum ratings](#) may cause permanent damage to the device. These are stress ratings only and operation of the device at these or any other conditions above those indicated in the operating sections of this specification is not implied. Exposure to absolute maximum rating conditions for extended periods may affect device reliability.

Table 3. Absolute maximum ratings

Symbol	Parameter	Value	Unit
V_{sdc}	DC supply voltage	-0.3 to 40	V
I_{sdc}	Input current	Internally limited	
V_{odc}	DC output voltage	-0.3 to 6	V
I_{odc}	DC output current	Internally limited	
$V_{od Res}$	Open drain output voltage R_{es}	-0.3 to $V_{odc} + 0.3$	V
$I_{od Res}$	Open drain output current R_{es}	Internally limited	
V_{Res_adj}	V_{Res_adj} voltage	-0.3 to $V_{odc} + 0.3$	V
$V_{od EWo}$	Open drain output voltage EW_o	-0.3 to $V_{odc} + 0.3$	V
$I_{od EWo}$	Open drain output current EW_o	Internally limited	
V_{cr}	V_{cr} voltage	-0.3 to $V_o + 0.3$	V
V_{EWi}	Early warning input voltage	-0.3 to 40	V
V_{En}	Enable input	-0.3 to 40	V
T_j	Junction temperature	-40 to 150	°C
VESD HBM	ESD HBM voltage level (HBM-MIL STD 883C)	± 2	kV
VESD CDM	ESD CDM voltage level (CDM-)	± 750	V

2.2 Thermal data

Table 4. Thermal data

Symbol	Parameter	Value ⁽¹⁾	Unit
$R_{thj-case}$	Thermal resistance junction to case: PowerSSO-12	20	°K/W
$R_{thj-amb}$	Thermal resistance junction to ambient: PowerSSO-12	52	°K/W

1. The values quoted are for PCB 77 mm x 86 mm x 1.6 mm, FR4, double copper layer with single heatsink layer, copper thickness 70 μm, thermal vias, copper area 2 cm².

2.3 Electrical characteristics

Values specified in this section are for $V_S = 5.6\text{ V to }31\text{ V}$, $T_J = -40\text{ °C to }+150\text{ °C}$ unless otherwise stated.

Table 5. General

Pin	Symbol	Parameter	Test condition	Min.	Typ.	Max.	Unit
V_o	V_{o_ref}	Output voltage	$V_S = 8\text{ V to }18\text{ V}$, $I_o = 8\text{ mA to }150\text{ mA}$	4.9	5.0	5.1	V
V_o	V_{o_ref}	Output voltage	$V_S = 5.6\text{ V to }31\text{ V}$, $I_o = 8\text{ mA to }150\text{ mA}$	4.85	5.0	5.15	V
V_o	V_{o_ref}	Output voltage	$V_S = 5.6\text{ V to }31\text{ V}$, $I_o = 0.1\text{ mA to }8\text{ mA}$	4.75	5.0	5.25	V
V_o	I_{short}	Short-circuit current	$V_S = 13.5\text{ V}$	0.65	0.95	1.25	A
V_o	I_{lim}	Output current capability ⁽¹⁾	$V_S = 13.5\text{ V}$	280	470	660	mA
V_S, V_o	V_{line}	Line regulation voltage	$V_S = 6\text{ V to }28\text{ V}$, $I_o = 30\text{ mA}$	–	–	40	mV
V_o	V_{load}	Load regulation voltage	$V_S = 8\text{ V to }18\text{ V}$, $I_o = 8\text{ mA to }150\text{ mA}$	–	–	55	mV
			$V_S = 13.5\text{ V}$, $T_J = 25\text{ °C}$, $I_o = 8\text{ mA to }150\text{ mA}$	–	–	40	
V_S, V_o	V_{dp}	Drop voltage ⁽²⁾	$I_o = 150\text{ mA}$	–	–	500	mV
V_S, V_o	SVR	Ripple rejection	$f_r = 100\text{ Hz}$ ⁽³⁾	–	48	–	dB
V_o	I_{oth_H}	Normal consumption mode output current	$V_S = 8\text{ V to }18\text{ V}$	8	–	–	mA
V_o	I_{oth_L}	Very low consumption mode output current	$V_S = 8\text{ V to }18\text{ V}$	–	–	1.1	mA
V_o	I_{oth_Hyst}	Output current switching threshold hysteresis	$V_S = 13.5\text{ V}$, $T_J = 25\text{ °C}$	–	0.8	–	mA
V_S, V_o	I_{qs}	Current consumption with regulator disabled $I_{qs} = I_{V_S} - I_o$	$V_S = 13.5\text{ V}$, $E_n = \text{low}$	–	5	10	μA
V_S, V_o	I_{qn_1}	Current consumption with regulator enabled $I_{qn_1} = I_{V_S} - I_o$	$V_S = 13.5\text{ V}$, $I_o = 0.1\text{ mA to }1\text{ mA}$, $E_n = \text{high}$ $T_J = 25\text{ °C}$	–	55	80	μA
			$V_S = 13.5\text{ V}$, $I_o = 0.1\text{ mA to }1\text{ mA}$, $E_n = \text{high}$	–	–	95	
V_S, V_o	I_{qn_150}	Current consumption with regulator enabled $I_{qn_150} = I_{V_S} - I_o$	$V_S = 13.5\text{ V}$, $I_o = 150\text{ mA}$, $E_n = \text{high}$	–	3.2	4.2	mA

Table 5. General (continued)

Pin	Symbol	Parameter	Test condition	Min.	Typ.	Max.	Unit
–	T_w	Thermal protection temperature	–	150	–	190	°C
–	T_{w_hy}	Thermal protection temperature hysteresis	–	–	10	–	°C

1. Measured output current when the output voltage has dropped 100 mV from its nominal value obtained at 13.5 V and $I_o = 75$ mA.
2. $V_s - V_o$ measured dropout when the output voltage has dropped 100 mV from its nominal value obtained at 13.5 V and $I_o = 75$ mA.
3. Guaranteed by design.

Table 6. Reset

Pin	Symbol	Parameter	Test condition	Min.	Typ.	Max.	Unit
R_{es}	V_{res_l}	Reset output low voltage	$R_{ext} = 5$ kW, $V_o > 1$ V	–	–	0.4	V
R_{es}	I_{Res_lkg}	Reset output high leakage current	$V_{Res} = 5$ V	–	–	1	μA
R_{es}	R_{Res}	Pull up internal resistance	Versus V_o	10	20	40	kΩ
R_{es}	V_{o_th}	V_o out of regulation threshold	$V_{Res_adj} < 0.2$ V, V_o decreasing	6	8	10	% Below V_{o_ref}
R_{es_adj}	V_{Res_adj}	Reset adjustable switching threshold	–	2.35	2.5	2.65	V
R_{es_adj}	V_{Res_adjl}	Reset adjustable low voltage	–	0.4	0.9	1.3	V
R_{es_adj}	$I_{Res_adj_lkg}$	Reset adjustable leakage current	$V_{Res_adj} = 2.5$ V	–1	–	1	μA
V_{cr}	V_{Rlth}	Reset timing low threshold	$V_S = 13.5$ V	15	18	22	% V_{o_ref}
V_{cr}	V_{Rhth}	Reset timing high threshold	$V_S = 13.5$ V	47	50	53	% V_{o_ref}
V_{cr}	I_{cr}	Charge current	$V_S = 13.5$ V	10	20	30	μA
V_{cr}	I_{dr}	Discharge current	$V_S = 13.5$ V	10	20	30	μA
R_{es}	T_{rr}	Reset reaction time	–	–	–	2	μs
R_{es}	T_{rd}	Reset delay time	$V_S = 13.5$ V, $C_{tr} = 1000$ pF	2	4	11	ms

Table 7. Early warning

Pin	Symbol	Parameter	Test condition	Min.	Typ.	Max.	Unit
EW _i	V _{EW_i_thl}	EW input low threshold voltage	–	2.35	2.50	2.65	V
EW _i	V _{EW_i_thh}	EW input high threshold voltage	–	2.42	2.57	2.72	V
EW _i	V _{EW_i_thhyst}	EW input threshold hysteresis	–	–	70	–	mV
EW _i	I _{EW_i_lkg}	EW input leakage current	V _{EW_i} = 2.5 V, V _S > 4 V	-1	–	1	μA
EW _o	R _{EW_o}	Pull up internal resistance	Versus V _o	10	20	40	kΩ
EW _o	V _{EW_o_lv}	EW output low voltage (with external pull up)	V _{EW_i} < 2.35 V, V _S > 4 V, R _{ext} = 5 kΩ	–	–	0.4	V
EW _o	I _{EW_o_lkg}	EW output leakage current	V _{EW_o} = 5 V	–	–	1	μA

Table 8. Enable

Pin	Symbol	Parameter	Test condition	Min.	Typ.	Max.	Unit
E _n	V _{E_n_low}	E _n input low voltage	–	–	–	1	V
E _n	V _{E_n_high}	E _n input high voltage	–	3	–	–	V
E _n	V _{E_n_hyst}	E _n input hysteresis	–	–	500	–	mV
E _n	I _{_leak}	Pull-down current	V _{E_n} = 5 V	–	1.8	10	μA

2.4 Electrical characteristics curves

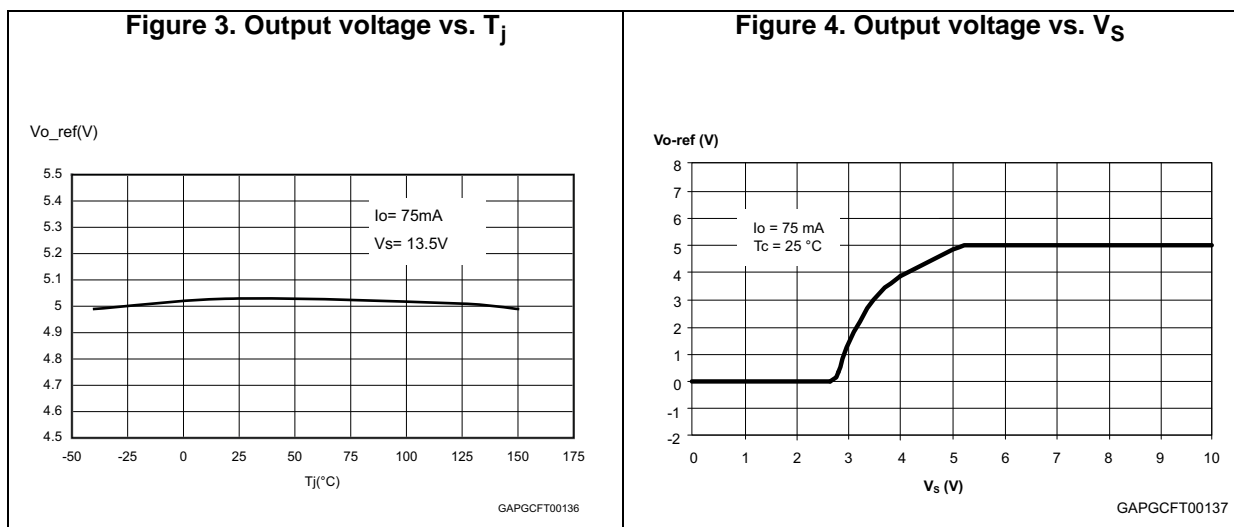

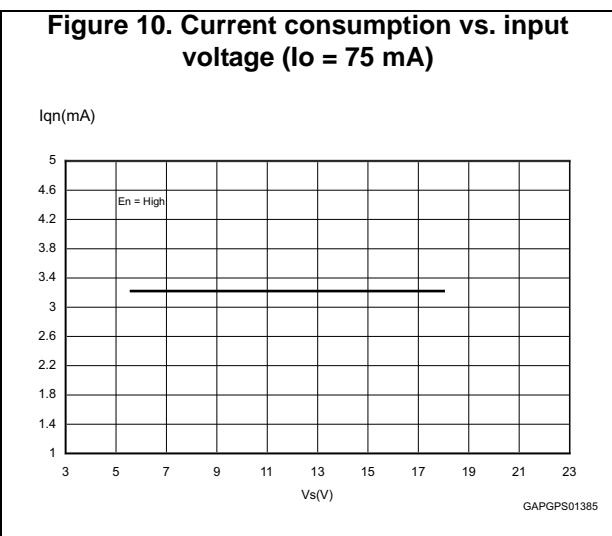
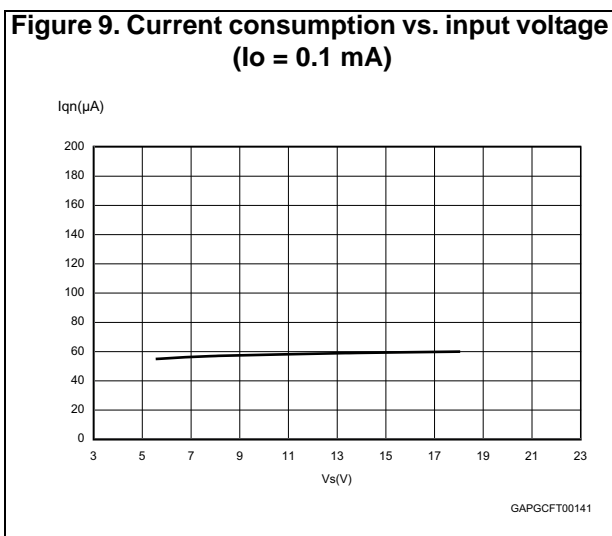
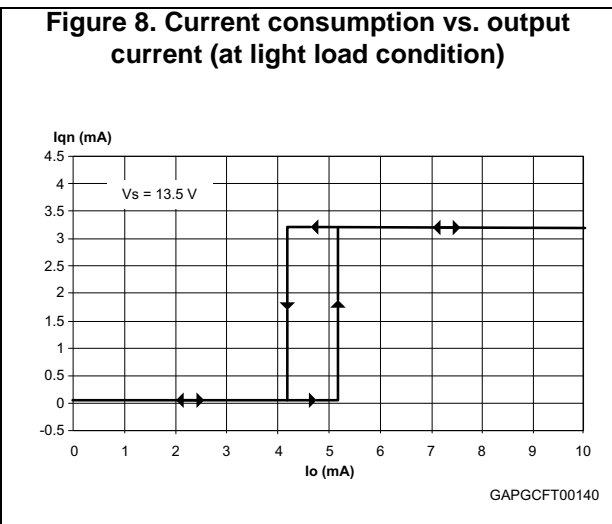
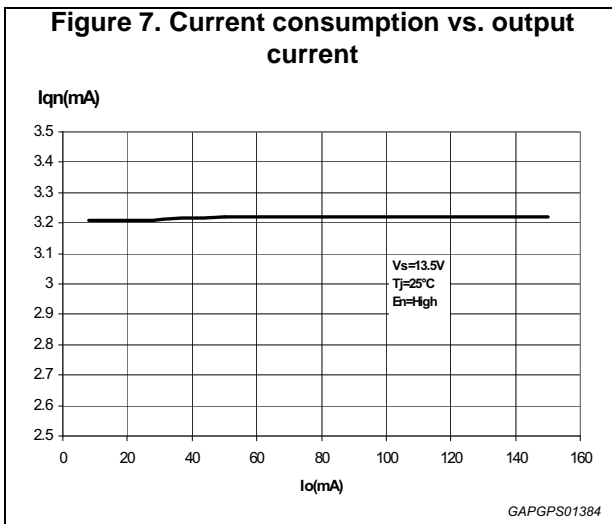
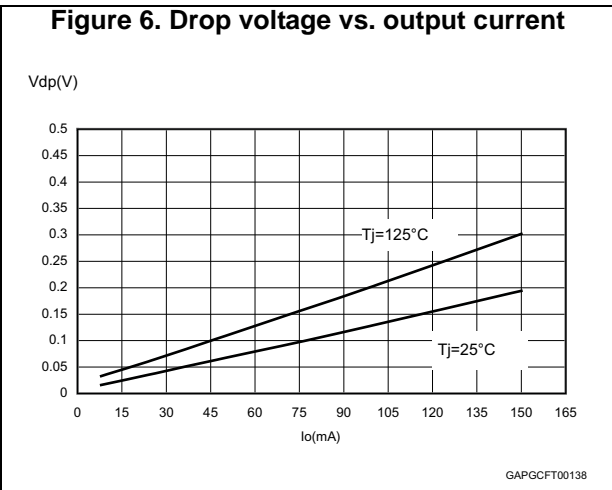
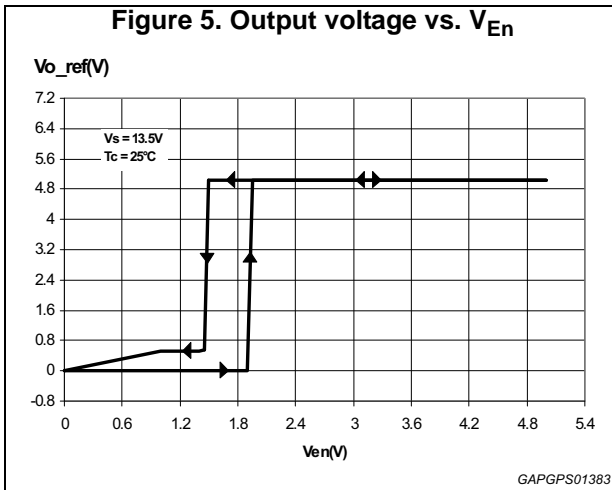

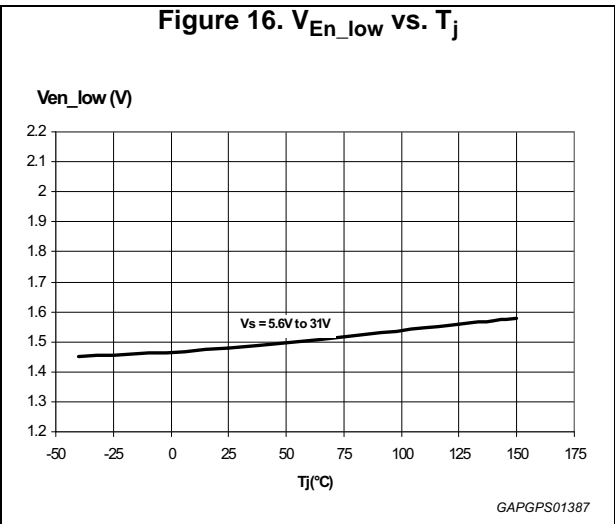
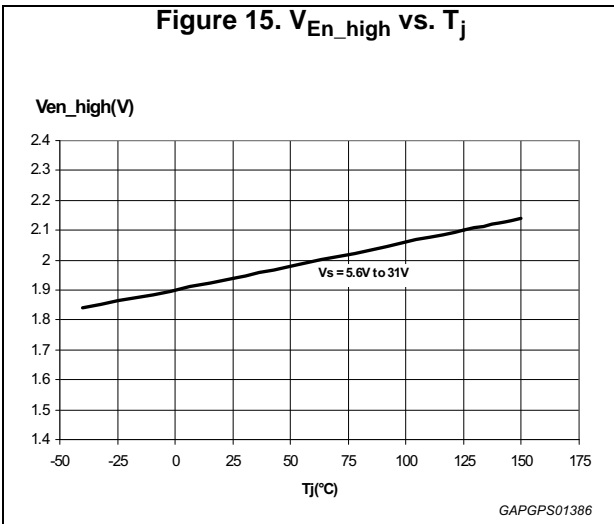
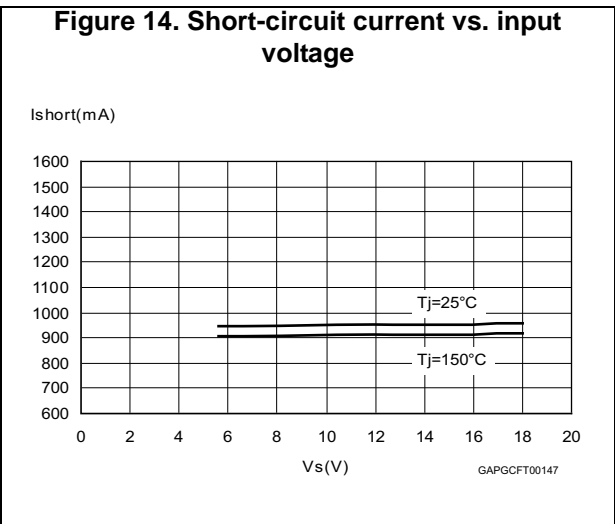
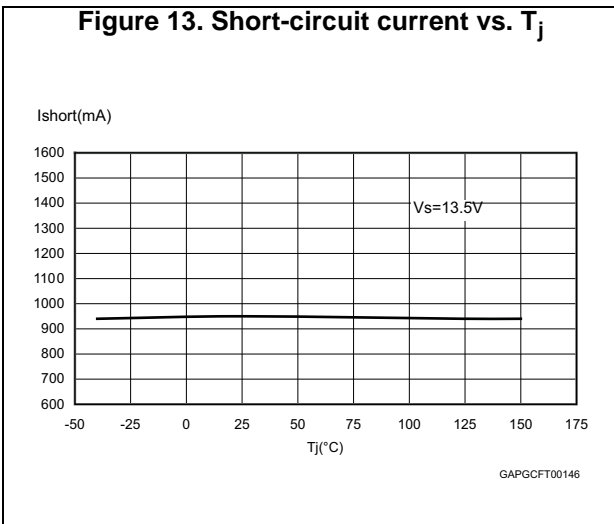
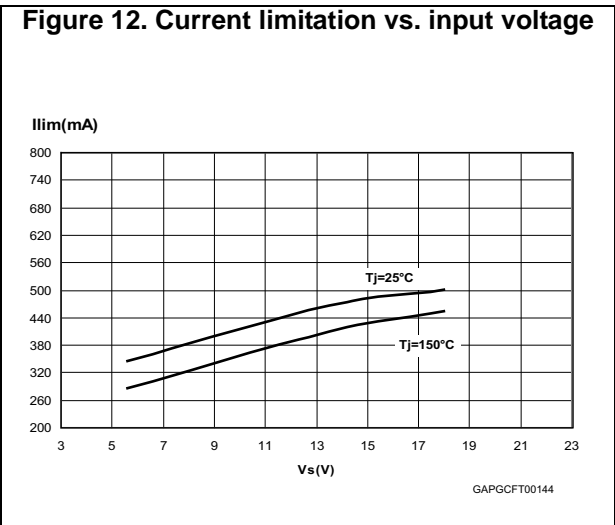
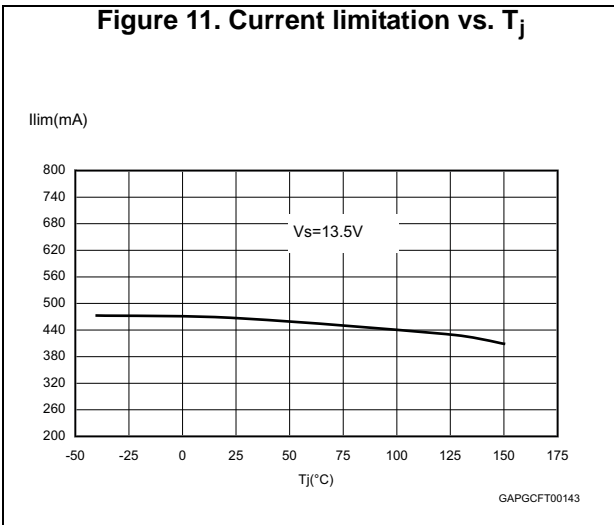

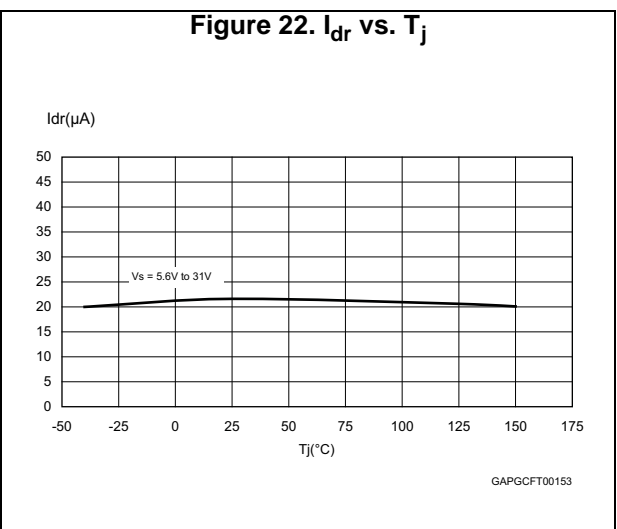
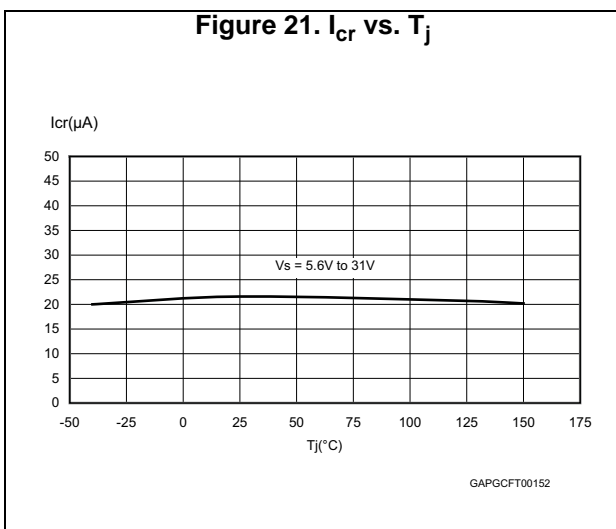
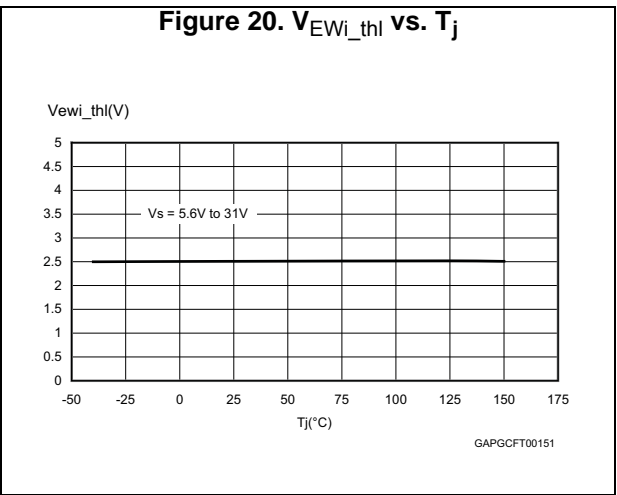
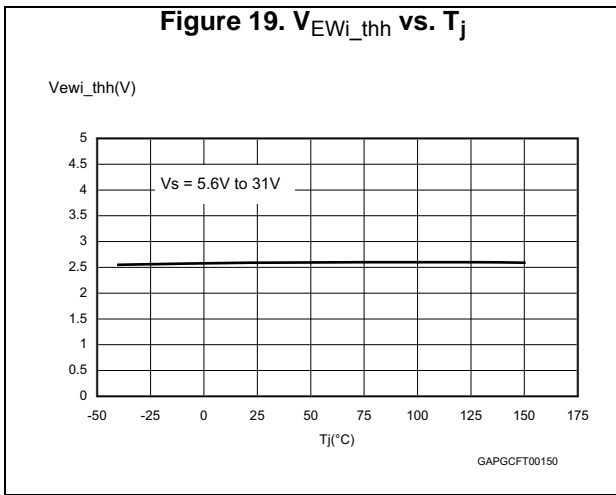
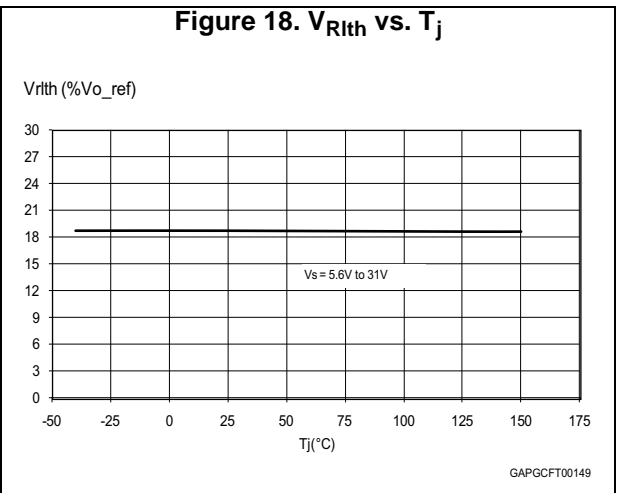
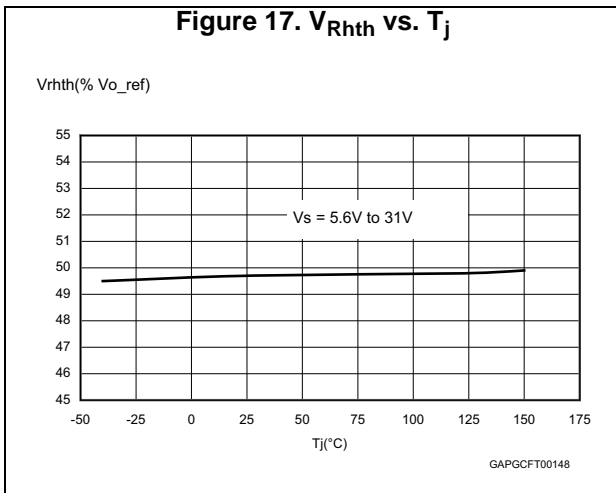
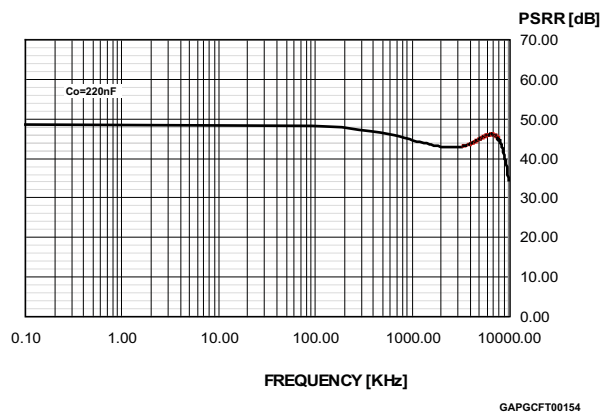

Figure 23. PSRR



3 Application information

3.1 Voltage regulator

The voltage regulator uses a p-channel mos transistor as a regulating element. With this structure a very low dropout voltage at current up to 150 mA is obtained. The output voltage is regulated up to input supply voltage of 40 V. The high-precision of the output voltage ($\pm 2\%$) is obtained with a pre-trimmed reference voltage. The voltage regulator automatically adapts its own quiescent current to the output current level. In light load conditions the quiescent current goes down to 55 μA only (low consumption mode). This procedure features a certain hysteresis on the output current (see [Figure 8](#)). Short-circuit protection to GND and a thermal shutdown are provided.

Figure 24. Application schematic

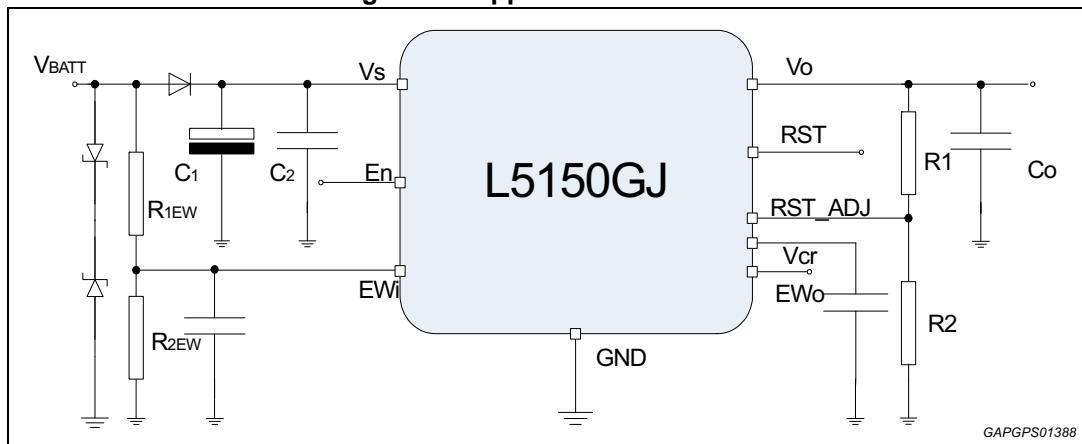

The input capacitor $C_1 \geq 100 \mu\text{F}$ is necessary as backup supply for negative pulses which may occur on the line. The second input capacitor $C_2 \geq 220 \text{ nF}$ is needed when the C_1 is too distant from the V_S pin and it compensates smooth line disturbances. The C_0 ceramic capacitor, connected to the output pin, is for bypassing to GND the high-frequency noise and it guarantees stability even during sudden line and load variations. Suggested value is $C_0 = 220 \text{ nF}$ with $\text{ESR} \geq 100 \text{ m}\Omega$.

Stability region is reported in [Figure 25](#).

Figure 25. Stability region

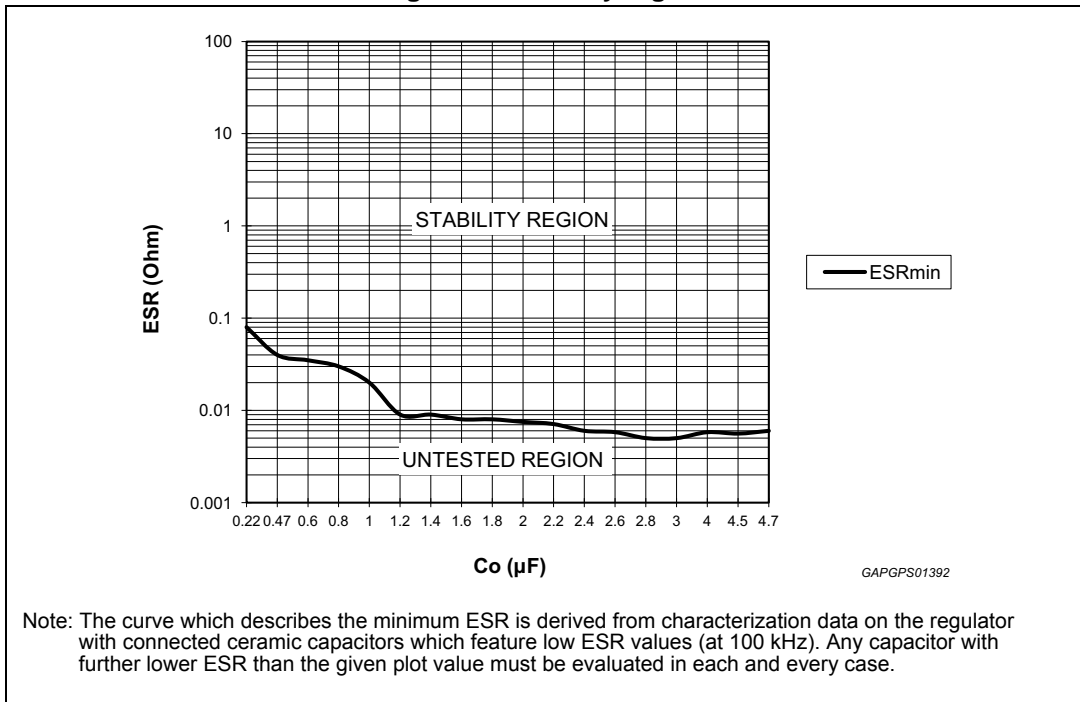
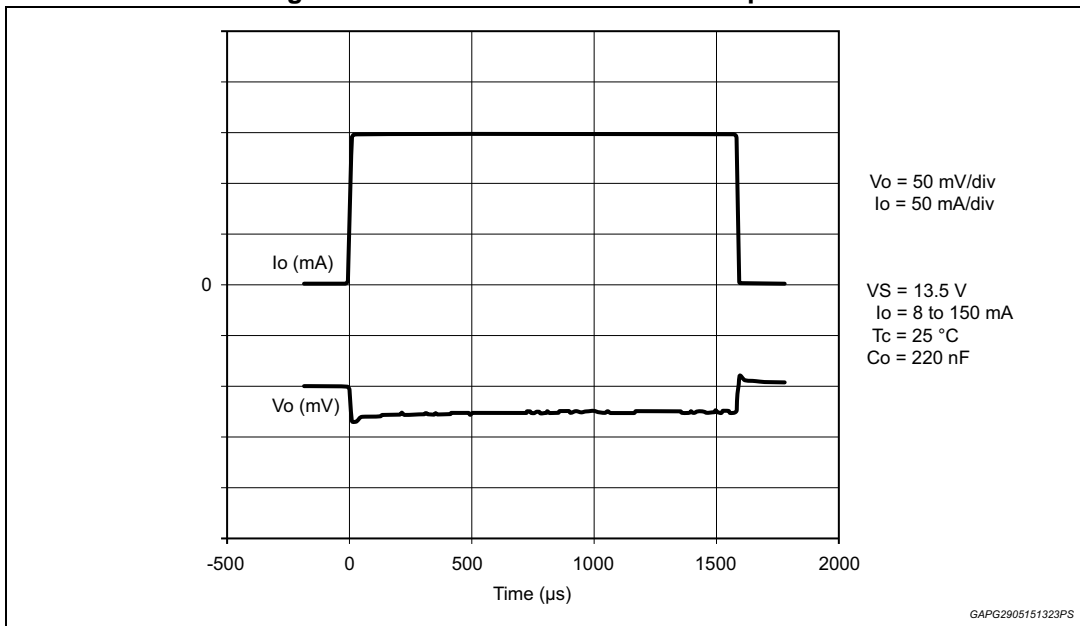

Figure 26. Maximum load variation response



3.2 Reset

The reset circuit monitors the output voltage V_o . If the output voltage becomes lower than V_{o_th} then R_{es} goes low with a delay time (t_{rr}). When the output voltage becomes higher than V_{o_th} then R_{es} goes high with a delay time t_{rd} . This delay is obtained by 32 periods of oscillator.

The oscillator period is given by:

Equation 1

$$T_{osc} = [(V_{Rhth} - V_{Rlth}) \times C_{tr}] / I_{cr} + [(V_{Rhth} - V_{Rlth}) \times C_{tr}] / I_{dr}$$

where:

I_{cr} = 20 μ A is an internally generated charge current,

I_{dr} = 20 μ A is an internally generated discharge current,

V_{Rhth} = 2.5 V (typ) and V_{Rlth} = 0.9 V (typ) are two voltage thresholds,

C_{tr} is an external capacitor put between V_{cr} pin and GND.

Reset pulse delay T_{rd} is given by:

Equation 2

$$t_{rd} = 32 \times T_{osc}$$

The Output Voltage Reset threshold can be adjusted via an external voltage divider $R_1 + R_2$ (R_1 connected between R_{es_Adj} and V_0 , R_2 connected between R_{es_Adj} and GND) according to the following formula:

Equation 3

$$V_{thre} = [(R_1 + R_2) / R_2] * V_{Res_adj}$$

The Output Voltage Reset threshold can be decreased down to 3.5 V. If it is needed to maintain it to its default value (8% below V_{o_ref} typical), it is enough to connect the R_{es_Adj} pin directly to GND.

Figure 27. Reset time diagram

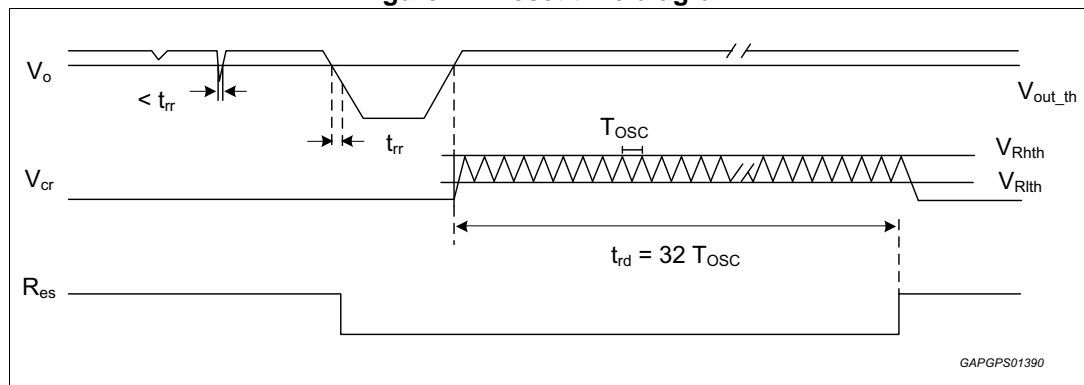

GAPGPS01390

3.3 Early warning

This circuit compares the EW_i input signal with the internal voltage reference (typically 2.5 V). The use of an external voltage divider makes the comparator very flexible in the application. This function can be used to supervise the supply input voltage either before or after the protection diode and to give additional information to the microprocessor such as low voltage warnings.

Figure 28. Early warning time diagram

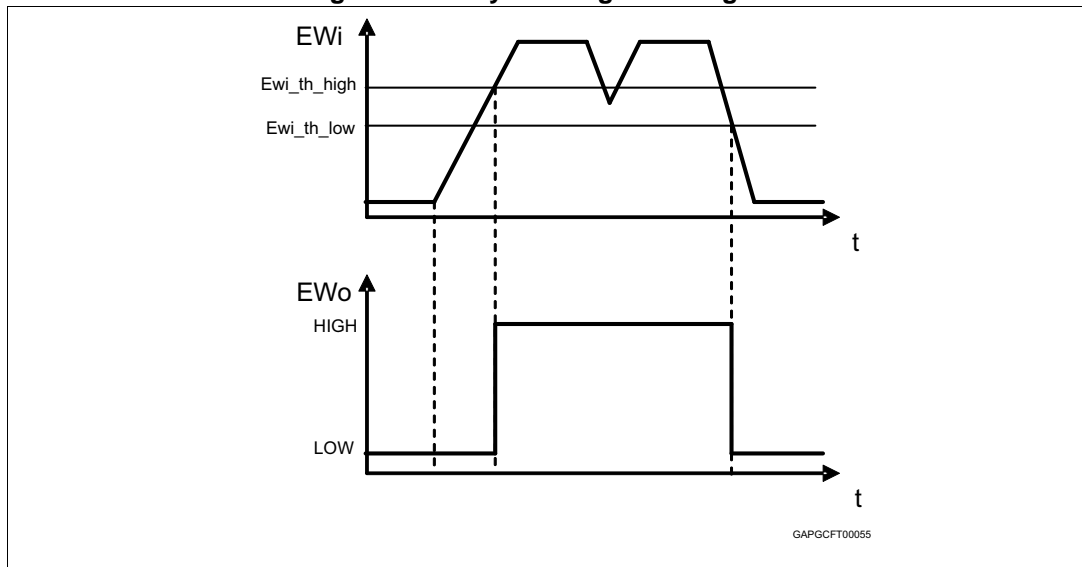

3.4 Enable

L5150GJ is also provided with an enable input, an high signal switches the regulator on. When the enable pin is set to low the output is switched-off and the current consumption of the device is 5 μ A typical.

4 Package and PCB thermal data

4.1 PowerSSO-12 thermal data

Figure 29. PowerSSO-12 PC board

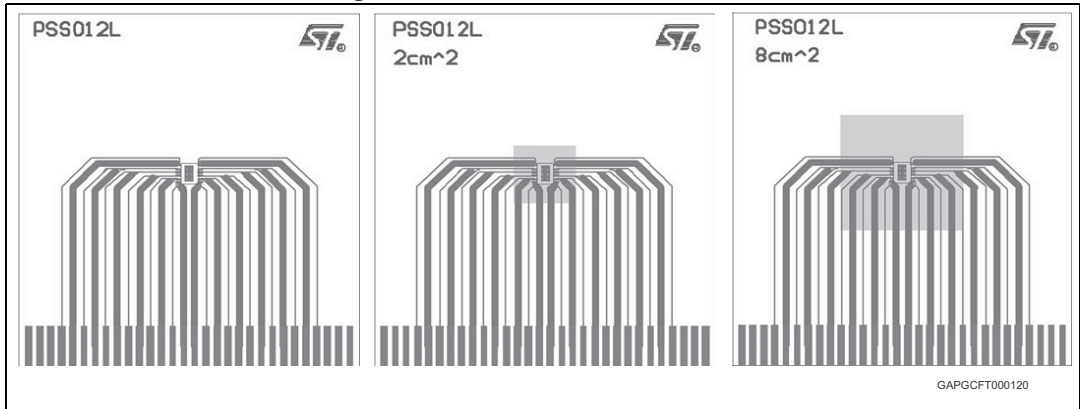

1. Layout condition of R_{th} and Z_{th} measurements (PCB: double layer, thermal vias, FR4 area = 77 mm x 86 mm, PCB thickness = 1.6 mm, Cu thickness = 70 μ m (front and back side) thermal vias separation 1.2 mm, thermal via diameter 0.3 mm +/- 0.08 mm, Cu thickness on vias 25 μ m, footprint dimension 4.1 mm x 6.5 mm).

Figure 30. $R_{thj-amb}$ vs PCB copper area in open box free air condition

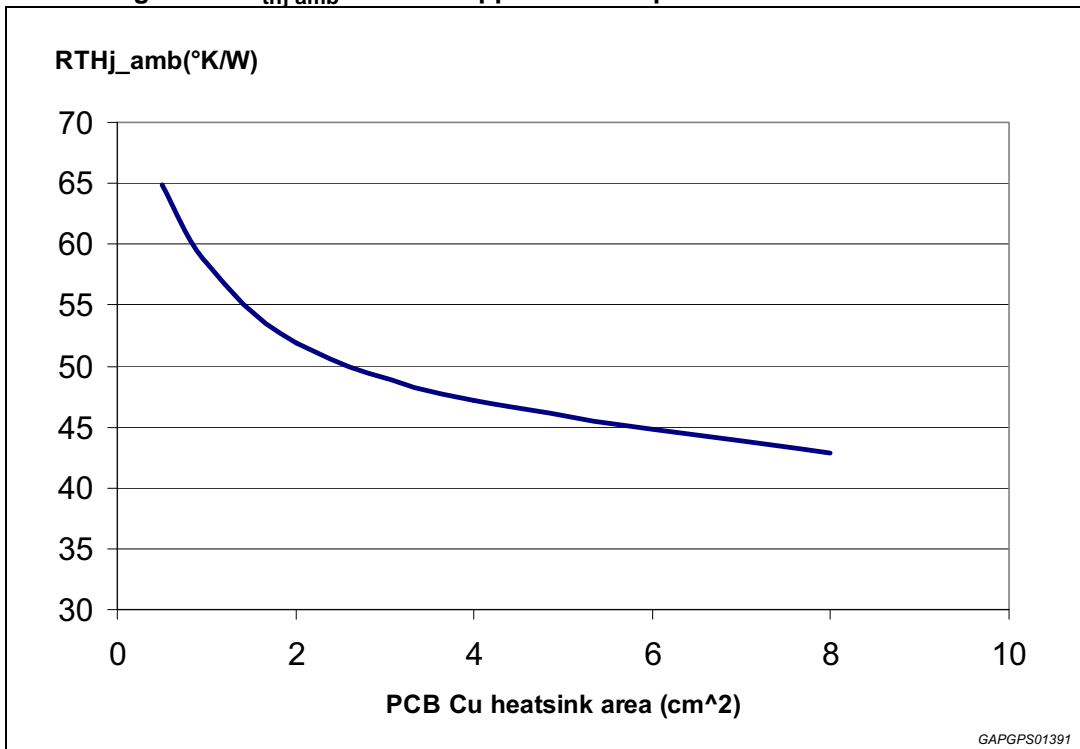
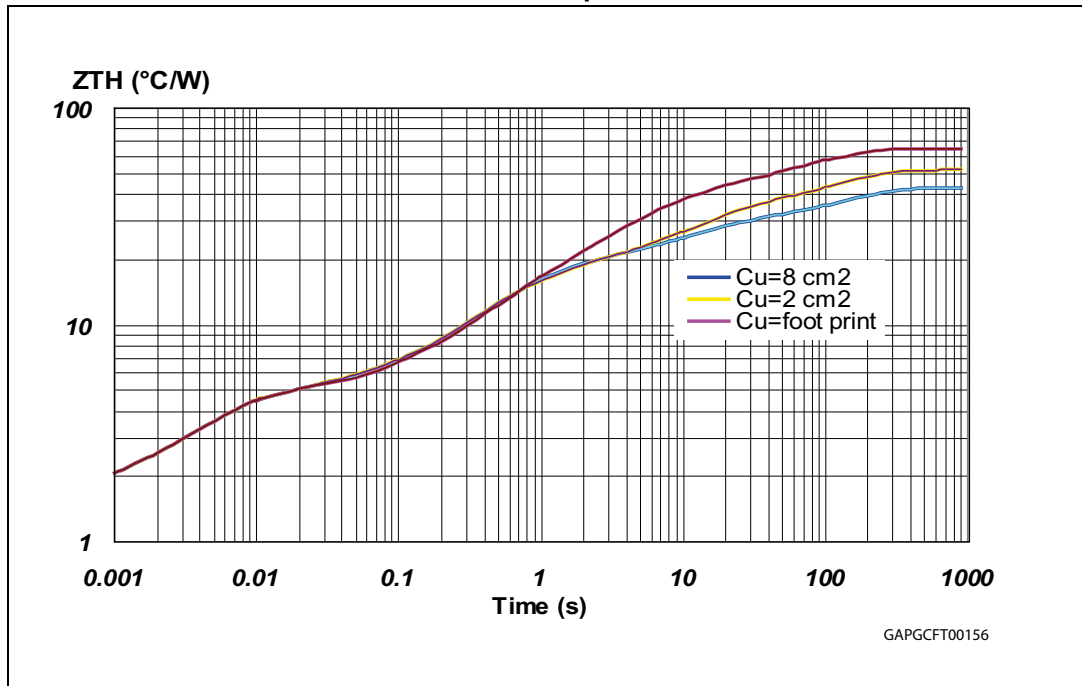

Figure 31. PowerSSO-12 thermal impedance junction ambient single pulse



Equation 4: pulse calculation formula

$$Z_{TH\delta} = R_{TH} \cdot \delta + Z_{THtp}(1 - \delta)$$

where $\delta = t_p/T$

Figure 32. Thermal fitting model of Vreg in PowerSSO-12

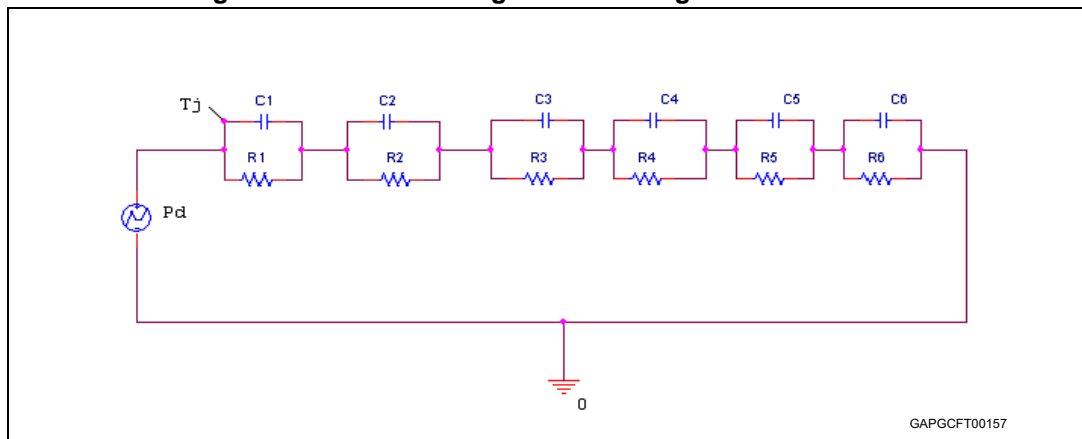

Table 9. PowerSSO-12 thermal parameter

Area (cm ²)	Footprint	2	8
R1 (°K/W)	1.53		
R2 (°K/W)	3.21		
R3 (°K/W)	5.2		
R4 (°K/W)	7	7	8
R5 (°K/W)	22	15	10
R6 (°K/W)	26	20	15
C1 (W.s/°K)	0.00004		
C2 (W.s/°K)	0.0016		
C3 (W.s/°K)	0.08		
C4 (W.s/°K)	0.2	0.1	0.1
C5 (W.s/°K)	0.27	0.8	1
C6 (W.s/°K)	3	6	9

5 Package information

In order to meet environmental requirements, ST offers these devices in different grades of ECOPACK® packages, depending on their level of environmental compliance. ECOPACK® specifications, grade definitions and product status are available at: www.st.com. ECOPACK® is an ST trademark.

5.1 PowerSSO-12 package information

Figure 33. PowerSSO-12 package outline

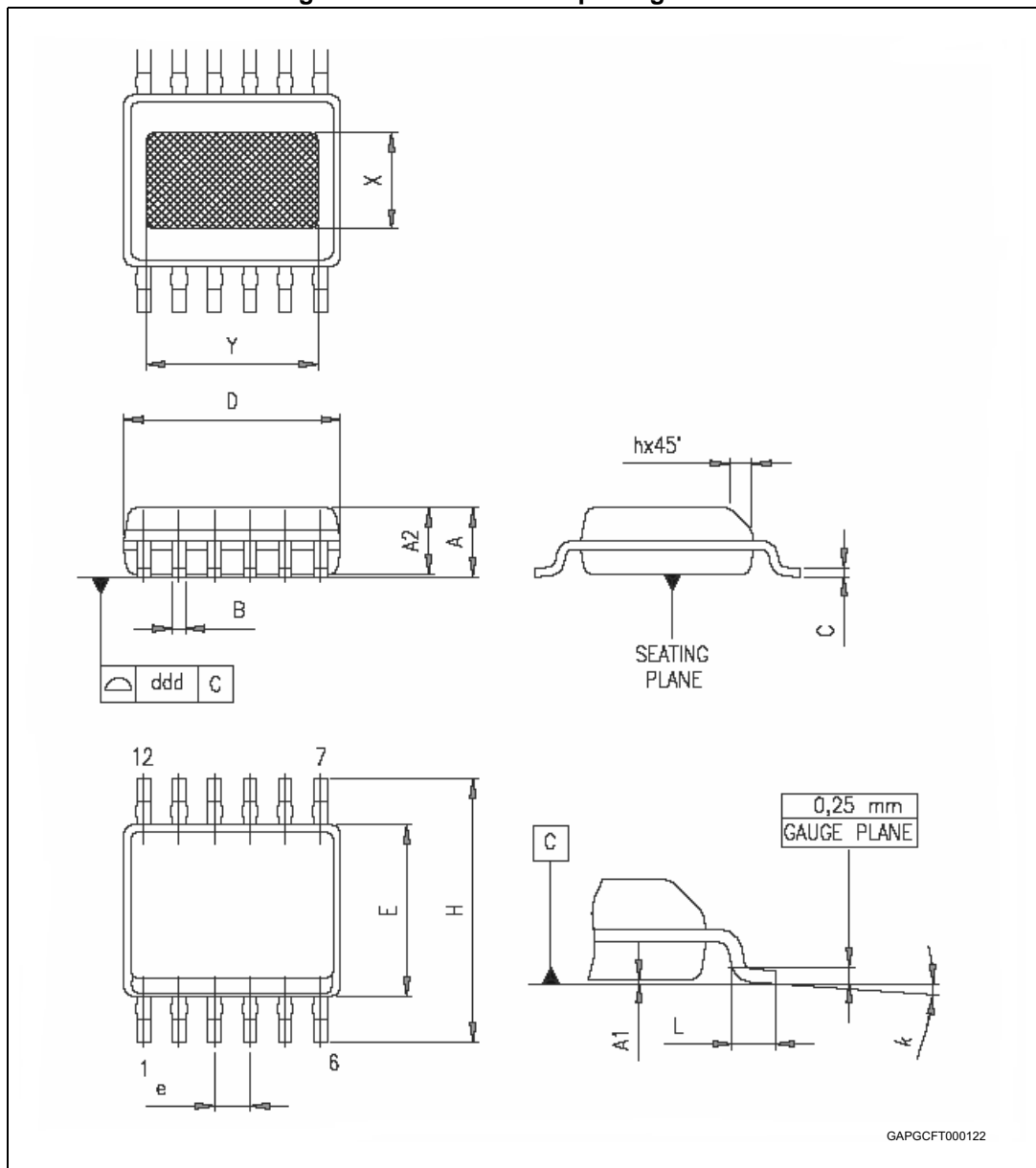

Table 10. PowerSSO-12 package mechanical data

Symbol	Millimeters		
	Min.	Typ.	Max.
A	1.250		1.620
A1	0.000		0.100
A2	1.100		1.650
B	0.230		0.410
C	0.190		0.250
D	4.800		5.000
E	3.800		4.000
e		0.800	
H	5.800		6.200
h	0.250		0.500
L	0.400		1.270
k	0°		8°
X	1.900		2.500
Y	3.600		4.200
ddd			0.100

5.2 PowerSSO-12 packing information

Figure 34. PowerSSO-12 tube shipment (no suffix)

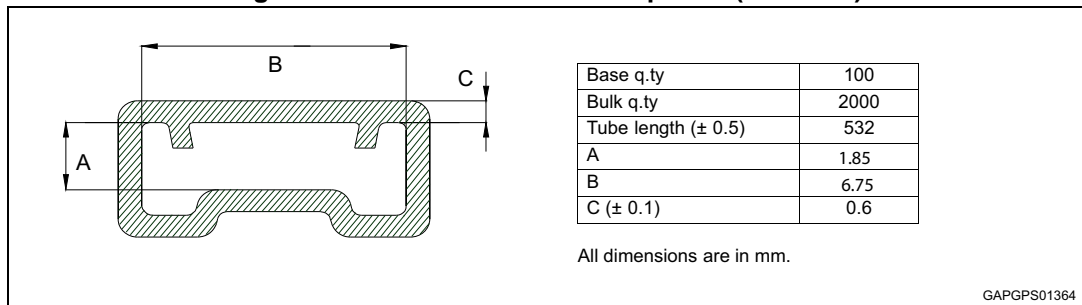
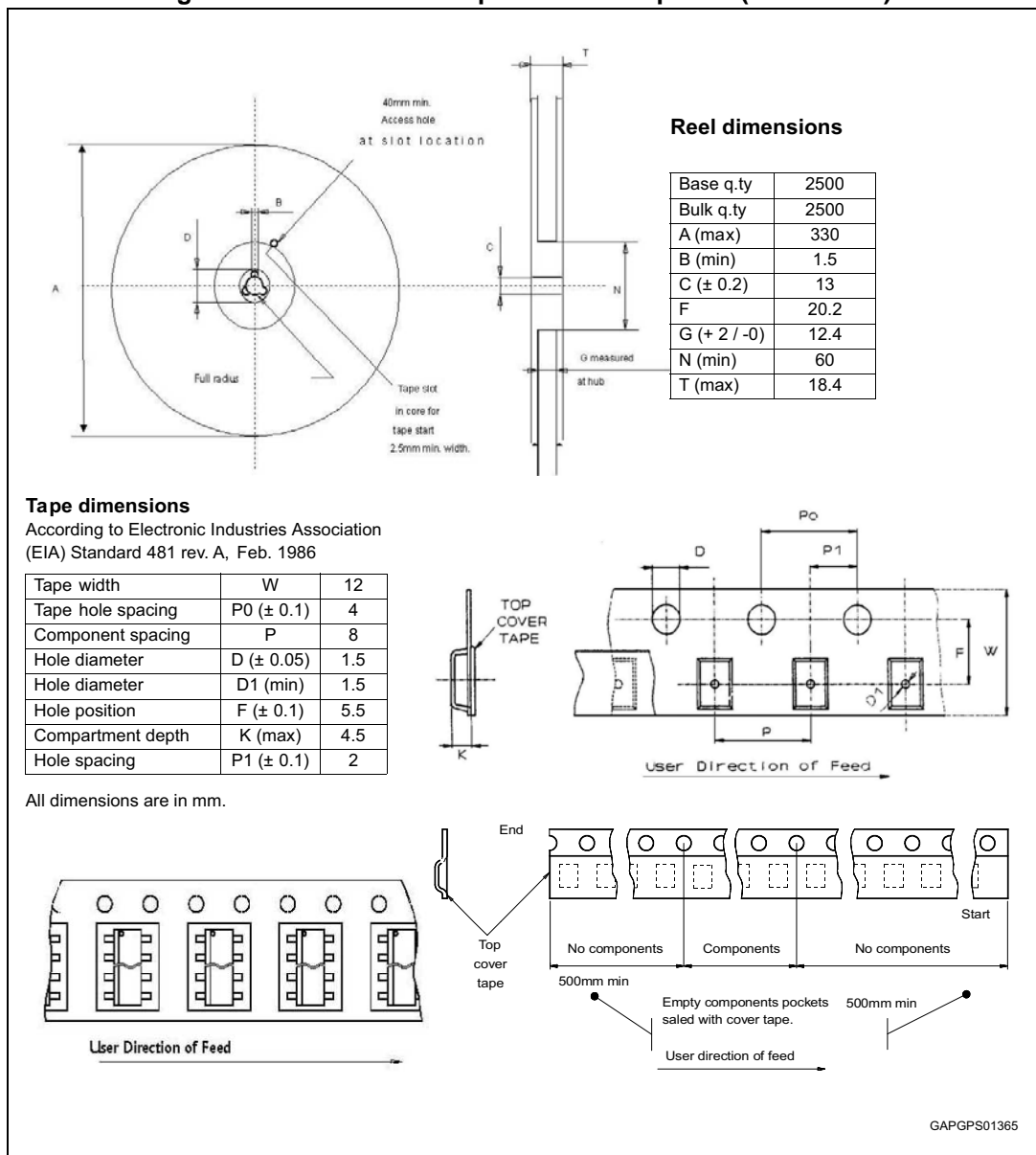

Figure 35. PowerSSO-12 tape and reel shipment (suffix "TR")



6 Revision history

Table 11. Document revision history

Date	Revision	Changes
09-Aug-2007	1	Initial release.
06-Mar-2008	2	<p>Modified Description on cover page.</p> <p>Updated Table 5.: General:</p> <ul style="list-style-type: none"> – changed V_{o_ref}, V_{line}, V_{load} test conditions – added notes to I_{lim} and V_{dp} parameters – added I_{oth_H}, I_{oth_L}, I_{oth} parameters. <p>Updated Table 6.: Reset:</p> <ul style="list-style-type: none"> – added V_{Res_adj} parameter – changed V_{Rlth} values (min./ typ./ max.) from 17/20/23 to 20/23/26 (% V_{o_ref}). <p>Updated Table 8.: Enable:</p> <ul style="list-style-type: none"> – changed V_{En_hyst} typ. value from 800 mV to 500 mV – changed I_{leak} typ. value from 3 μA to 1.8 μA. <p>Modified Section 3.2: Reset.</p>
09-May-2008	3	<p>Updated Table 5.: General :</p> <ul style="list-style-type: none"> – changed I_{lim} values (Min./Typ./Max.) from 0.7/1/1.30 A to 280/470/660 mA. – V_{o_ref} parameter : updated I_o test condition Old -> $I_o = 0.1$ mA to 10mA New -> $I_o = 0.1$ mA to 8 mA.
13-Oct-2008	4	<p>Updated Table 5.: General :</p> <ul style="list-style-type: none"> – V_{load} parameter : updated I_o test condition Old -> $I_o = 5$ mA to 150 mA New -> $I_o = 8$ mA to 150 mA

Table 11. Document revision history (continued)

Date	Revision	Changes
15-Apr-2009	5	<p>Updated corporate template</p> <p>Updated Figure 2: Configuration diagram (top view)</p> <p>Table 2: Pins description</p> <ul style="list-style-type: none"> – Added new row <p>Table 4: Thermal data</p> <ul style="list-style-type: none"> – $R_{thj-amb}$: changed value – Updated TableFootnote <p>Table 5: General</p> <ul style="list-style-type: none"> – V_{load}: changed max value for $V_S = 8\text{ V}$ to 18 V, added new row – I_{qn_1}: changed Test conditions (added $T_j = 25\text{ °C}$), added new row <p>Table 6: Reset</p> <ul style="list-style-type: none"> – V_{Rlth}: changed min/typ/max value – V_{Res_adjl}: replaced with V_{Rlth}, changed Parameter <p>Table 7: Early warning</p> <ul style="list-style-type: none"> – Updated symbols <p>Added Figure 3: Output voltage vs. T_j</p> <p>Added Figure 4: Output voltage vs. V_S</p> <p>Added Figure 5: Output voltage vs. V_{En}</p> <p>Added Figure 6: Drop voltage vs. output current</p> <p>Added Figure 7: Current consumption vs. output current</p> <p>Added Figure 8: Current consumption vs. output current (at light load condition)</p> <p>Added Figure 9: Current consumption vs. input voltage ($I_o = 0.1\text{ mA}$)</p> <p>Added Figure 10: Current consumption vs. input voltage ($I_o = 75\text{ mA}$)</p> <p>Added Figure 11: Current limitation vs. T_j</p> <p>Added Figure 12: Current limitation vs. input voltage</p> <p>Added Figure 13: Short-circuit current vs. T_j</p> <p>Added Figure 14: Short-circuit current vs. input voltage</p> <p>Added Figure 15: V_{En_high} vs. T_j</p> <p>Added Figure 16: V_{En_low} vs. T_j</p> <p>Added Figure 17: V_{Rhth} vs. T_j</p> <p>Added Figure 18: V_{Rlth} vs. T_j</p> <p>Added Figure 19: V_{EWi_thh} vs. T_j</p> <p>Added Figure 20: V_{EWi_thl} vs. T_j</p> <p>Added Figure 21: I_{cr} vs. T_j</p> <p>Added Figure 22: I_{dr} vs. T_j</p> <p>Added Figure 23: PSRR</p> <p>Section 3.1: Voltage regulator</p> <ul style="list-style-type: none"> – Updated text – Added Figure 24: Application schematic – Added Figure 26: Maximum load variation response <p>Section 3.2: Reset</p> <ul style="list-style-type: none"> – V_{Rlth}: changed value from 1.15 V to 0.9 V in Equation 1 <p>Updated Section 3.4: Enable</p> <p>Added Section 4: Package and PCB thermal data</p> <p>Changed Section 5.1: ECOPACK®</p>

Table 11. Document revision history (continued)

Date	Revision	Changes
09-Jun-2009	6	<p>Changed document title</p> <p><i>Table 5: General</i></p> <p>– $I_{\text{oth_H}}$, $I_{\text{oth_L}}$: added test condition</p> <p>Updated <i>Figure 4: Output voltage vs. V_S</i></p> <p><i>Section 3.3: Early warning</i></p> <p>– changed internal voltage reference typical value from 1.23 V to 2.5 V</p> <p>Updated <i>Figure 31: PowerSSO-12 thermal impedance junction ambient single pulse</i></p>
04-Dec-2009	7	<p>Updated features list.</p> <p>Updated <i>Table 2: Pins description</i>.</p> <p>Updated <i>Section 3.1: Voltage regulator</i>.</p> <p>Corrected <i>Equation 3</i> on <i>Section 3.2: Reset</i>.</p>
19-Apr-2010	8	<p>Updated footnote description of <i>Table 4: Thermal data</i>.</p> <p>Updated <i>Figure 30: $R_{\text{thj-amb}}$ vs PCB copper area in open box free air condition</i>.</p> <p>Updated <i>Table 9: PowerSSO-12 thermal parameter</i>.</p>
30-Jan-2012	9	Updated <i>Figure 25: Stability region on page 16</i> .
07-Feb-2012	10	Modified <i>Figure 25: Stability region on page 16</i> .
02-Oct-2012	11	<p>Updated <i>Table 6: Reset</i>.</p> <p>– T_{rd}: updated maximum value</p>
19-Sep-2013	12	Updated disclaimer.
03-Jun-2015	13	Changed in <i>Table 5</i> the typical value of SVR from 60 dB to 48 dB.
27-Sep-2018	14	Updated title and <i>Features</i> .

IMPORTANT NOTICE – PLEASE READ CAREFULLY

STMicroelectronics NV and its subsidiaries ("ST") reserve the right to make changes, corrections, enhancements, modifications, and improvements to ST products and/or to this document at any time without notice. Purchasers should obtain the latest relevant information on ST products before placing orders. ST products are sold pursuant to ST's terms and conditions of sale in place at the time of order acknowledgement.

Purchasers are solely responsible for the choice, selection, and use of ST products and ST assumes no liability for application assistance or the design of Purchasers' products.

No license, express or implied, to any intellectual property right is granted by ST herein.

Resale of ST products with provisions different from the information set forth herein shall void any warranty granted by ST for such product.

ST and the ST logo are trademarks of ST. All other product or service names are the property of their respective owners.

Information in this document supersedes and replaces information previously supplied in any prior versions of this document.

© 2018 STMicroelectronics – All rights reserved

Mouser Electronics

Authorized Distributor

Click to View Pricing, Inventory, Delivery & Lifecycle Information:

[STMicroelectronics:](#)

[L5150GJ](#) [L5150GJTR](#)