

THIS DOCUMENT IS THE PROPERTY OF
KEYSTONE ELECTRONICS CORP. AND
SHALL NOT BE REPRODUCED, DISTRIBUTED
OR USED AS A BASIS FOR MANUFACTURE
WITHOUT PRIOR WRITTEN PERMISSION
FROM KEYSTONE ELECTRONICS CORP.

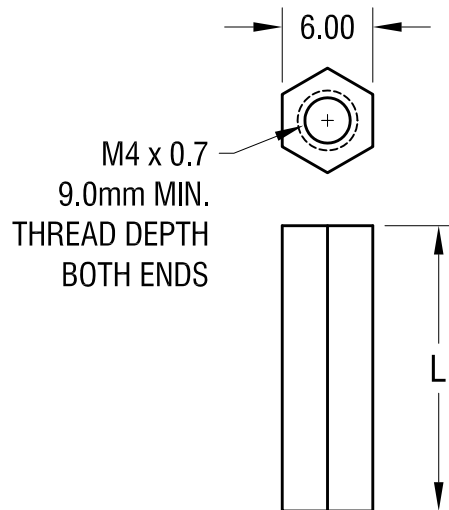

PART NO.	'L' DIM.
25534	20.00
25535	25.00

NOTE:

1. ALL DIMENSIONS ARE IN MILLIMETERS

KEYSTONE ELECTRONICS CORP.			
www.keyelco.com • ASTORIA, N.Y. 11105-2017 • Tel (718) 956-8900			
PART NAME			
6.0mm THREADED HEX STANDOFF			
MATERIAL			
NYLON 6/6			
FINISH		DRN BY	DATE
-		BOONE	10.11.06
		APP'D	SCALE
		LN	2X
TOLERANCES	INCH	[MM]	CODE
DECIMAL	±	[± 0.40]	C
ANGULAR	± 1°		
UNLESS OTHERWISE SPECIFIED			DWG NO.
			25534-25535

DATE	DESCRIPTION	REV.

Mouser Electronics

Authorized Distributor

Click to View Pricing, Inventory, Delivery & Lifecycle Information:

[Keystone Electronics:](#)

[25535](#)